

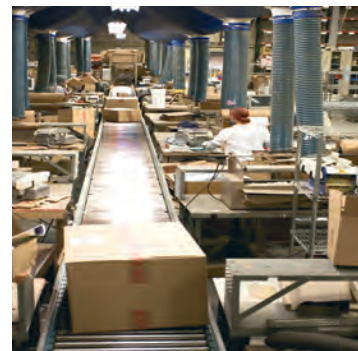

Pneumatic Valve Products

Air Control Valves, Flow Controls & Accessories

Catalog 0600P-13



ENGINEERING YOUR SUCCESS.

Distributor Network, Warning, Offer of Sale**DISTRIBUTION NETWORK**

At Parker, we have the largest global distribution network in motion and control, with over 7,500 distributors serving more than 422,000 customers.

To find the distributor nearest you, please visit our DISTRIBUTOR LOCATOR at <http://www.parker.com/pneu/distributor>



ENGINEERING YOUR SUCCESS.

⚠ WARNING

FAILURE OR IMPROPER SELECTION OR IMPROPER USE OF THE PRODUCTS AND/OR SYSTEMS DESCRIBED HEREIN OR RELATED ITEMS CAN CAUSE DEATH, PERSONAL INJURY AND PROPERTY DAMAGE.

This document and other information from Parker Hannifin Corporation, its subsidiaries and authorized distributors provide product and/or system options for further investigation by users having technical expertise. It is important that you analyze all aspects of your application including consequences of any failure, and review the information concerning the product or system in the current product catalog. Due to the variety of operating conditions and applications for these products or systems, the user, through its own analysis and testing, is solely responsible for making the final selection of the products and systems and assuring that all performance, safety and warning requirements of the application are met.

The products described herein, including without limitation, product features, specifications, designs, availability and pricing, are subject to change by Parker Hannifin Corporation and its subsidiaries at any time without notice.

Offer of Sale

The items described in this document are hereby offered for sale by Parker Hannifin Corporation, its subsidiaries or its authorized distributors. This offer and its acceptance are governed by the provisions stated on the separate page of this document entitled "Offer of Sale".



**Product Index,
Engineering Data**

A
Product Index
Engineering Data

Direct Acting Valves

***XM Series, 15mm Solenoid Valve,
A00 Solenoid Valve***

B
Direct Acting
Valves

Inline Valves

***Viking Lite Series, Viking Xtreme Series,
"B3, B5, B6" Series, "B7 & B8" Series,
Air Saver Unit, "N" Series***

C
Inline Valves

Subbase & Manifolds Valves

***H Series Micro, Moduflex Series,
H Series ISO, Network Connectivity,
"DX" ISOMAX Series, Valvair II Series***

D
Subbase & Manifold
Valves

Manual Mechanical Valves

***Directair 2 & 4 Series, Viking Xtreme
Manual Series, "42" Lever / Pedal Series,
"MO" Series, Safety, Brass Poppet /
Sliding Seal / "PL" / "VL" / "HV" Series,
Control Panel Products, Sensing Products***

E
Manual / Mechanical
Valves

Accessories

***Flow Controls, Check Valves, Mufflers,
Quick Exhaust & Shuttle Valves, Tank Valves,
Breather Vents, Silencers, Blocking Valves,
Blow Guns, Integrated Fittings***

F
Accessories

**Part Number Index,
Safety Guide, Offer of Sale**

G
Page Number Index,
Safety Guide,
Offer of Sale



For inventory, lead times, and kit
lookup, visit www.pdnplu.com

A

Product Index
 Engineering Data

Product Index

Engineering Data

Direct Acting Valves

XM Series - Direct Acting



B2

- Inline or stacking
- 1/8 inch ports
- Pressures 0 to 125 PSIG
- Temperatures 32°F to 125°F
- Flow - .15 Cv

15mm Series - Direct Acting



B9

- Subbase or manifold
- 1/8 inch ports
- Pressures VAC to 145 PSIG
- Temperatures 5°F to 140°F
- Flow - .033 to .05 Cv

Inline Valves

Viking Lite Series Valves



C2

- Inline or bar manifold
- 1/8 through 3/8 inch ports
- Pressures 22 to 145 PSIG
- Temperatures 14°F to 122°F
- Flow - .6 to 2.5 Cv

Viking Xtreme Series Valves



C11

- Inline or bar manifold
- 1/8 through 1/2 inch ports
- Pressures VAC to 232 PSIG
- Temperatures -40°F to 140°F
- Flow - .7 to 2.7 Cv

B Series Valves



C41

- Inline, subbase or bar manifold
- 1/8 through 3/4 inch ports
- Pressures VAC to 145 PSIG
- Temperatures 5°F to 120°F
- Flow - .75 to 7.0 Cv

Air Saver Valve Units



C74

- Large reduction in air consumption
- Savings in compressor power consumption
- Reduction in plant CO² emissions
- Big contribution to energy-saving activities
- Improved efficiency

ADEX Series Valves



C83

- Inline, subbase or bar manifold
- M3, M5, 1/8 inch ports
- Pressures VAC to 100 PSIG
- Temperatures 32°F to 122°F
- Flow - .1 to .47 Cv

N Series - Inline Poppet Valves



C96

- Inline mounted
- 3/8 through 1-1/2 inch ports
- Pressures 30 to 250 PSIG
- Temperatures 0°F to 200°F
- Flow - 3.6 to 29.9 Cv



For inventory, lead times, and kit lookup, visit www.pdnplu.com

Subbase & Manifold Valves

H Series Micro Valve



D2

- Subbase or manifold
- 4mm through 1/4 tube
- Pressures VAC to 145 PSIG
- Temperatures 5°F to 120°F
- Flow - .35 Cv

Manual / Mechanical Valves

Directair 2 & 4



E2

- Manual / mechanical
- 1/8 and 1/4 inch ports
- Pressures VAC to 150 PSIG
- Temperatures 32°F to 175°F
- Flow - .20 to .84 Cv

Moduflex Series Valves



D28

- Inline or stacking
- 4mm tube, 1/4, 3/8 inch ports
- Pressures VAC to 120 PSIG
- Temperatures 5°F to 140°F
- Flow - .18 to .80 Cv

Viking Xtreme Lever Series



E14

- Manual / mechanical
- 1/8, 1/4 and 3/8 inch ports
- Pressures:
 - Type A & B - VAC to 232 PSIG
 - Type C & D - VAC to 174 PSIG
- Temperatures -40°F to 140°F
- Flow - .5 to 2.7 Cv

H Series ISO Valve



D71

- Subbase or manifold
- 1/8 through 3/4 inch ports
- Pressures VAC to 145 PSIG
- Temperatures 5°F to 120°F
- Flow - .55 to 6.0 Cv

42 Lever / Pedal Series



E21

- Manual / mechanical
- 1/4 and 3/8 inch ports
- Pressures VAC to 150 PSIG
- Temperatures 0°F to 140°F
- Flow - 1.3 to 2.9 Cv

Network Connectivity



D145

- Network connectivity for H Series and Moduflex valves
- Up to 256 inputs
- Up to 256 outputs
- Digital or analog

MO Series



E24

- Air Pilot, Manual / mechanical
- 1/4 and 1 inch ports
- Pressures VAC to 225 PSIG
- Temperatures -15°F to 200°F
- Flow - .5 to 1.25 Cv

DX ISOMAX Series



D213

- Subbase or manifold
- 1/8 through 3/4 inch ports
- Pressures VAC to 145 PSIG
- Temperatures 14°F to 140°F
- Flow - .55 to 4.15 Cv

Safety



E52

- LV/EZ shut off valves
- Port sizes 3/8 through 1-1/4 inch
- Max. supply pressure 300 PSIG
- Max. operating temperature 175°F
- Cv from 3.7 to 14
- Two hand tiedown controls

Valvair II Series



D257

- Subbase or manifold
- 3/8 through 1-1/2 inch ports
- Pressures VAC to 225 PSIG
- Temperatures 0°F to 200°F
- Flow - 1.9 to 12.0 Cv

Brass Poppet, Sliding Seal



E62

- 4-way, 3-position rotary disc, direct air operated valves
- Pressures 0 to 150 PSIG
- Temperatures 18°F to 200°F
- Flow - 2.5 to 6.2 Cv

A

Product Index
 Engineering Data

Product Index

Engineering Data

Manual / Mechanical Valves

Control Panel Products



- A wide variety of push buttons and selector switches
- Visual indicators
- Foot pedal switches
- Modular pneumatic / electric push buttons

E67

Sensing / Limit Switches



- Limit switches in a variety of sizes and configurations
- Pressure switches with many adjustable ranges
- Components designed specifically for pneumatic technology using pressure variation, air bleed or blocking for detection

E77

Accessories

Flow Control & Check Valves



- Flow controls
 - 1/8 to 1-1/2 inch ports
- Check valves
 - 1/8 to 3/4 inch ports

F2

Misc Accessories



- Exhaust mufflers
- Quick exhaust & shuttle valves
- Threshold valves
- Tank valves
- Blow guns

F14

Integrated Fittings



- Flow controls
- Check valves
- Blocking valves

F25

Part Number Index, Safety Guides, Offer of Sale



- Part Number to Page Number Index
- Safety Guide
- Offer of Sale

G2



PNEUMATIC DIVISION E-TOOLS

A

Pneumatic Division Part Lookup Tool

Part Lookup Tool Overview

The purpose of this application is to provide users with more in depth detail, such as replacement kits or current inventory for specific pneumatic part numbers. The tool also provides cross reference information for products that have been previously obsoleted. Searches can be made by searching a portion or all of a part number. Use the drop down options available to narrow your search.



Part Lookup Tool Contents

- Replacement KITS by part number
- Obsolete cross reference
- Inventory/stock levels
- Pricing (with distributor login only)
- Bulk part search
- Shipping location
- Lead time

How to access the Tool

U.S. Parker Pneumatic Distributors

- www.pdnpartlookup.com
- Or download the “Distributor Toolbox” app

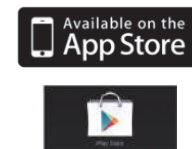

Guest Users

- www.pdnplu.com

Product Index
Engineering Data

Product
Index

Engineering
Data

Pneumatic Division Size & Selection Calculators

Size, Selection and Cost of Air Calculators Overview

The purpose of this application is to provide users and designers of pneumatic systems with a handy collection of compressed air cost calculators, conversion tools and air valve (Cv) and flow (SCFM) calculations for air cylinder actuation. The size and select calculators are available to anyone for use. See details below.

How to access the Tool

- www.parkerpdncalc.com
- Or download the “Pneumatics” calculator app

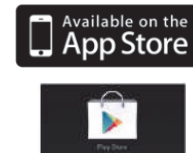
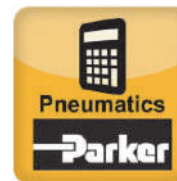

Calculator Contents

- Cost calculator for leaks
- Cost calculator for compressors
- Cost calculator for reverse flow regulators
- Vacuum flow through an orifice
- Air flow through an orifice
- Annual cost of air cylinder operation
- Valve/FRL sizing for cylinder actuation
- And more!

A

Product Index
Engineering Data

Product Index

Engineering Data

The Parker 5-Year Extended Warranty

Parker Hannifin Corporation will extend its warranty on all pneumatic components to sixty (60) months providing they are correctly installed and protected by Parker pneumatic filters which are properly maintained. Components covered by this warranty include all cylinders, valves, and pneumatic automation components manufactured by Parker in any of our global facilities. This warranty covers our components anywhere in the world you may ship your equipment.

Parker's obligation under this warranty is limited to the replacement or repair of any failed components. The buyer understands that the seller will not be liable for any other costs or damages.

The buyers of quality Parker components and filters benefit by having ONE source for all pneumatic needs - **Parker.**



A handwritten signature in black ink that reads 'Jennifer Parmentier'.

Jennifer Parmentier
President
Motion Systems Group



Application Engineering Data

Engineering Data

Selection Guide	A2
Fluid Power Graphic Symbols	A3
Direct Acting Solenoid Valves	A4
Solenoid Air Pilot Valves	A5-A7
Manual Valves	A8
IP Ratings, Symbols	A9
ISO Mounting Information	A10

A

Product Index
Engineering Data

Product
Index

Engineering
Data



For inventory, lead times, and kit lookup, visit www.pdnplu.com

A
Product Index
Engineering Data
Product Index
Engineering Data

Saving Money and Space by Sizing Your Valves Properly

This catalog gives you a flow rating (Cv) for each valve in the Parker Hannifin line. You can “plug” your requirements into the following simple formula, and determine the Cv needed to do the job. By not oversizing, you’ll save space and money, and you’ll ensure the valve you select will do the job.

Converting the Job Requirements Into Cv (Capacity Co-efficient).

$$Cv = \frac{\text{Cylinder Area (Sq. In.)} \times \text{Stroke (In.)} \times \text{Compression Factor (Table 2)} \times \text{“A” (Table 2)}}{\text{Stroke Time (sec.)} \times 28.8}$$

Let’s work through an example:

We want to extend a 3 1/4" bore cylinder which has a 12" stroke in one second, and we have a supply pressure of 80 PSI to do the work. Here’s what we know:

- Cylinder Area for a 3-1/4" Bore, from Table 18.30 sq. in.
- Cylinder Stroke..... 12 in.
- Stroke Time Required in Seconds.....1 sec.
- Compression Factor at 80 PSI, from Table 2..... 6.4
- “A” Constant for 80 PSI, from Table 2......048

Substituting in the formula, we have:

$$Cv = \frac{8.30 \times 12 \times 6.4 \times .048}{1 \times 28.8} = 1.06$$

Any valve, therefore, which has a Cv of at least 1.06, will extend our cylinder the specified distance in the required time.

Choosing the Valve “Series”

Your next step is to choose a basic valve design to do the job. For a quick guide to valve designs, see Table 3.

Having selected the basic valve design, consult the Capacity Co-efficient (Cv) tables which describe the individual valve capacities.

Selecting the Valve Model, Options and Accessories

Having determined Cv, series, port size, flow-path configuration (pre-determined by circuit design), and actuation method, you’re ready to choose the exact valve model number.

Read the pertinent catalog pages; note the exact model numbers, options and accessories you want. Then phone or write your Parker Hannifin air valve distributor. They will give you prompt, accurate service.

Note: Need circuit design help? Contact your local Parker Hannifin distributor. They are backed up by our regional Sales Engineers and offices. Between them, you’ll find answers to all of your questions.

Table 1
Effective Square-Inch Areas for Standard-Bore-Size Cylinders

Bore Size	Cylinder Area (Sq. In.)	Bore Size	Cylinder Area (Sq. In.)
3/4"	.44	4"	12.57
1"	.79	4-1/2"	15.90
1-1/8"	.99	5"	19.64
1-1/4"	1.23	6"	28.27
1-1/2"	1.77	7"	38.48
1-3/4"	2.41	8"	50.27
2"	3.14	10"	78.54
2-1/2"	4.91	12"	113.10
3-1/4"	8.30	14"	153.94
3-5/8"	10.32		

Table 2
Compression Factors and “A” Constants

Inlet Pressure (PSIG)	Compression Factor	“A” Constants for Various Pressure Drop*		
		2 PSI ΔP	5 PSI ΔP	10 PSI ΔP
10	1.6	.152	.103	
20	2.3	.126	.084	.065
30	3.0	.111	.073	.055
40	3.7	.100	.065	.048
50	4.4	.091	.059	.044
60	5.1	.085	.055	.040
70	5.7	.079	.051	.037
80	6.4	.075	.048	.035
90	7.1	.071	.046	.033
100	7.8	.068	.044	.032
110	8.5	.065	.042	.030
120	9.2	.063	.040	.029
130	9.9	.061	.039	.028
140	10.6	.058	.037	.027
150	11.2	.057	.036	.026
160	11.9	.055	.035	.025
170	12.6	.053	.034	.024
180	13.3	.052	.033	.024
190	14.0	.051	.032	.023
200	14.7	.050	.032	.023

Note: Use “A” constant at 5 PSI ΔP for most applications. On very critical applications, use “A” at 2 PSI ΔP. You will find in many cases, a 10 PSI ΔP is not detrimental, and can save money and mounting space.

* Tabulated values are the solution of $\frac{1}{22.48} \sqrt{\frac{GT}{(P_1 - P_2) P_2}}$ where T is for 68°F and G = 1 for Air.

Table 3
Characteristics of the Major Valve Designs

A. Poppet 3-Way and 4-Way	1. High flow capacities 2. Minimum lubrication requirements 3. Fast response 4. Self-cleaning poppet seats 5. Pressures of 15 to 150 PSIG (modifications for vacuum to 250 PSIG)
B. Spool Valves (WCS) 3-Way and 4-Way	1. Low friction 2. Lower operating pressures 3. Fast response 4. Less wear 5. Long Cycle Life - Under pressure, radial expansion of the seal occurs to maintain sealing contact with the valve bore 6. Non-Lube Service - No lubrication required for continuous valve shifting 7. Bi-Directional Spool Seals - Common spool used for any pressure, including vacuum
C. Packed Bore 4-Way	1. Wide range of flow capacities 2. Wide range of flow-path configurations 3. Pilot-operated models available 4. Pressures of vacuum to 150 PSIG
D. Rotary Or Reciprocating Disc 4-Way, manually operated	1. Inexpensive 2. Versatility in manual actuation

Cv – Capacity Co-efficients (sometimes called Flow Factors). Each flow path through the valve has its own Cv value. All Cv ratings for each valve cataloged on this page are listed on the front side of this sheet.

Q = Flow in Standard Cubic Feet per minute (14.7 PSIA at 60°F)
 P₁ = Inlet Absolute Pressure (gauge pressure + 14.7)
 P₂ = Outlet Absolute Pressure (gauge pressure + 14.7)
 Note: P₂ must be greater than .53 x P₁
 G = Specific Gravity of flowing medium (Air, G = 1)
 T = Absolute Temperature of Air (460 + °F)

$$Cv = \frac{Q}{22.48} \sqrt{\frac{GT}{(P_1 - P_2) P_2}}$$

Cv = Q x “A” (Table 2)



For inventory, lead times, and kit lookup, visit www.pdnplu.com

Air Preparation Units

Symbol Description



Filter / Separator with manual drain



Filter / Separator with automatic drain



Oil Removal Filter



Automatic Drain



Lubricator less drain



Lubricator with manual drain



Lubricator with automatic filling



Air Line Pressure Regulator adjustable, relieving

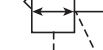

Air Line Pressure Regulator pilot controlled, relieving

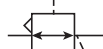

Filter / Regulator (piggyback) manual drain relieving (with gauge)

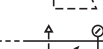

Filter / Regulator (piggyback) auto drain relieving



Air Line Combo F-R-L simplified

Pneumatic Valves

Symbol Description

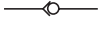

Check



Flow Control



Relief Valve

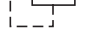

2-Position, 2-Way

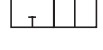

2-Position, 3-Way



2-Position, 4-Way

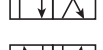

2-Position, 4-Way 5-Ported

Pneumatic Valves

Symbol Description



3-Position, 4-Way, APB ports closed, center pos.

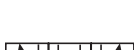

3-Position, 4-Way, CE 5-Ported cylinder ports open to exhaust in center position



3-Position, 4-Way, PC 5-Ported pressure port open to cylinder ports in center position

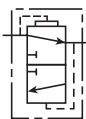

Quick Exhaust

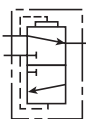

Shuttle

Valve Actuators

Symbol Description



Manual general symbol



Push Button



Lever



Pedal or Treadle

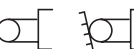

Mechanical cam, toggle, etc.



Spring

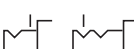

Detent line indicates which detent is in use



Piezo



Solenoid



Internal Pilot Supply

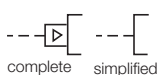

Remote Pilot Supply



And / Or Composite solenoid and pilot or manual override



And / Or Composite solenoid and pilot or manual override and pilot

Cylinders

Symbol Description



Standard double acting



Single Acting



Double Rod



Spring Return

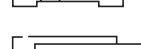

Ram Type



Telescope



Tandem



Duplex

Lines and Functions

Symbol Description



Solid Line - Main Line



Dashed Line - Pilot Line

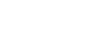

Dotted Line - Exhaust or Drain Line



Center Line - Enclosure Outline



Lines Crossing (90° intersection not necessary)



Lines Joining (90° intersection not necessary)



Lines Joining



Flow Direction hydraulic medium

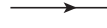

Flow Direction gaseous medium

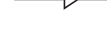

Energy Source



Line with Fixed Restriction



Line with Adjustable Restriction



Flexible Line



Plugged Port, Test Station, Power Take-off

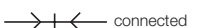

connected Quick Disconnect Without Checks

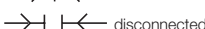

disconnected

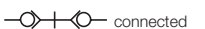

connected Quick Disconnect With Checks

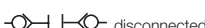

disconnected

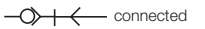

connected Quick Disconnect With One Check

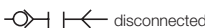

disconnected

A

Product Index
Engineering Data

Product Index

Engineering Data



For inventory, lead times, and kit lookup, visit www.pdnplu.com

A

Product Index
Engineering Data

Product Index

Engineering Data

3-Way, 2-Position, Normally Closed

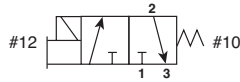

De-energized position – Solenoid #12 de-energized. Pressure at inlet port 1 blocked, outlet port 2 connected to exhaust port 3.

Energized position – Solenoid #12 energized. Pressure at inlet port 1 is connected to outlet port 2, exhaust port 3 is blocked.

3-Way, 2-Position, Diverter

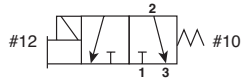

De-energized position – Solenoid #12 de-energized. Pressure at inlet port 2 connected to outlet port 3. Port 1 is blocked.

Energized position – Solenoid #12 energized. Pressure at inlet port 2 is connected to outlet port 1. Port 3 is blocked.

2-Way, 2-Position, Normally Closed

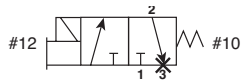

De-energized position – Solenoid #12 de-energized. Pressure at inlet port 1 blocked, port 2 is connected to port 3, which is plugged.

Energized position – Solenoid #12 energized. Pressure at inlet port 1 is connected to outlet port 2. Port 3 is blocked.

X Plug port 3.

4-Way, 2-Position

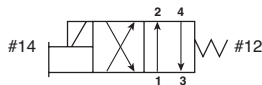

De-energized position – Solenoid #14 de-energized. Pressure at inlet port 1 connected outlet port 2. Outlet port 4 connected to exhaust port 3.

Energized position – Solenoid #14 energized. Pressure at inlet port 1 is connected to outlet port 4. Outlet port 2 connected to exhaust port 3.

3-Way, 2-Position, Normally Open

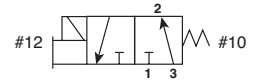

De-energized position – Solenoid #12 de-energized. Pressure at inlet port 3 connected to outlet port 2, exhaust port 1 is blocked.

Energized position – Solenoid #12 energized. Pressure at inlet port 3 blocked, outlet port 2 connected to exhaust port 1.

3-Way, 2-Position, Selector

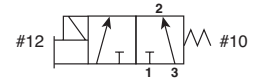

De-energized position – Solenoid #12 de-energized. Pressure at inlet port 1 is blocked. Pressure at inlet port 3 is connected to outlet port 2.

Energized position – Solenoid #12 energized. Pressure at inlet port 1 is connected to outlet port 2. Pressure at port 3 is blocked.

2-Way, 2-Position, Normally Open

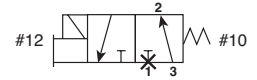

De-energized position – Solenoid #12 de-energized. Pressure at inlet port 3 is connected to outlet port 2. Port 1 is blocked.

Energized position – Solenoid #12 energized. Pressure at inlet port 3 is blocked. Port 2 is connected to port 1, which is plugged.

X Plug port 1.

4-Way, 2-Position with Flow Controls

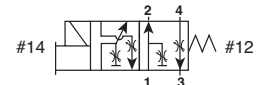

De-energized position – Solenoid #14 de-energized. Pressure at inlet port 1 connected outlet port 2. Outlet port 4 connected to exhaust port 3.

Energized position – Solenoid #14 energized. Pressure at inlet port 1 is connected to outlet port 4. Outlet port 2 connected to exhaust port 3.

Flow Controls meter exhaust from ports 2 and 4 separately into port 3.



Single Solenoid
4-Way, 2-Position

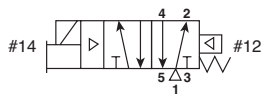

De-energized position – Solenoid operator #14 de-energized. Pressure at inlet port 1 connected to outlet port 2. Outlet port 4 connected to exhaust port 5.

Energized position – Solenoid operator #14 energized. Pressure at inlet port 1 connected to outlet port 4. Outlet port 2 connected to exhaust port 3.

Double Solenoid
4-Way, 2-Position

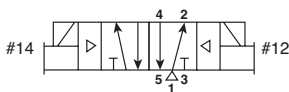

Solenoid operator #14 energized last. Pressure at inlet port 1 connected to outlet port 4. Outlet port 2 connected to exhaust port 3.

Solenoid operator #12 energized last. Pressure at inlet port 1 connected to outlet port 2. Outlet port 4 connected to exhaust port 5.

Single Remote Pilot
4-Way, 2-Position

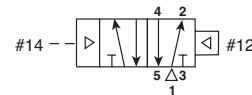

Normal position – Pressure at inlet port 1 connected to outlet port 2. Outlet port 4 connected to exhaust port 5.

Operated position – Maintained air signal at port 14. Pressure at inlet port 1 connected to outlet port 4. Outlet port 2 connected to exhaust port 3.

Double Remote Pilot
4-Way, 2-Position

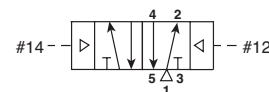

Momentary air signal at port 14 last. Pressure at inlet port 1 connected to outlet port 4. Outlet port 2 connected to exhaust port 3.

Momentary air signal at port 12 last. Pressure at inlet port 1 connected to outlet port 2. Outlet port 4 connected to exhaust port 5.

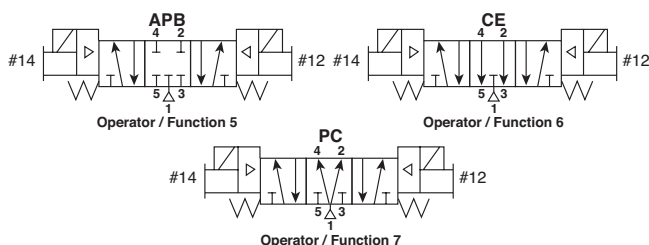

Double Solenoid
4-Way, 3-Position

With #12 operator energized – inlet port 1 connected to cylinder port 2, cylinder port 4 connected to exhaust port 5.

With #14 operator energized – inlet port 1 connected to cylinder port 4, cylinder port 2 connected to exhaust port 3.

Function 5: All Ports Blocked

All ports blocked in the center position.

Function 6: Center Exhaust

Cylinder ports 2 and 4 connected to exhaust ports 3 and 5 in center position. Port 1 is blocked.

Function 7: Pressure Center

Pressure port 1 connected to cylinder ports 2 and 4, and exhaust ports 3 and 5 blocked in center position.

Dual Pressure:

May be used for dual pressure service with pressure at ports 3 & 5. (Use either external pilot source option “K”, “W” or “X”, or dual pressure pilot source option “D” or “E”.) If pilot source “D” or “E” is selected, the high pressure must be at port #3. If pilot source “K”, “W” or “X” is selected, the external pilot must be plumbed to port #14 or “X” respectively. Note: The “B6” valve is also available with dual pressure using Port 5 for high pressure (Option “G” & “H”). This is only to be used if converting from a “42” (“CM”) Series traditional valve.

In the 3-Position valve, the effect of dual pressure is extremely important when the valve is in the center position, as the CE and PC functions are reversed. Therefore, care should be used when selecting a 3-Position valve.

Double Remote Pilot
4-Way, 3-Position

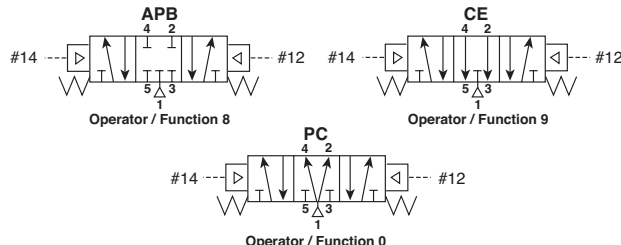

With #12 operator signaled – inlet port 1 connected to cylinder port 2, cylinder port 4 connected to exhaust port 5.

With #14 operator signaled – inlet port 1 connected to cylinder port 4, cylinder port 2 connected to exhaust port 3.

Function 8: All Ports Blocked

All ports blocked in the center position.

Function 9: Center Exhaust

Cylinder ports 2 and 4 connected to exhaust ports 3 and 5 in center position. Port 1 is blocked.

Function 0: Pressure Center

Pressure port 1 connected to cylinder ports 2 and 4, and exhaust ports 3 and 5 blocked in center position.

A

Product Index
Engineering Data

Product Index

Engineering Data

Single Solenoid
3-Way, 2-Position, NC (NNP)

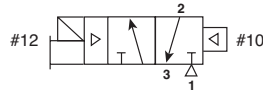

Normally Closed:

De-energized position – Solenoid #12 de-energized. Pressure at inlet port 1 blocked, outlet port 2 connected to exhaust port 3.

Energized position – Solenoid #12 energized. Pressure at inlet port 1 connected to outlet port 2, exhaust port 3 is blocked.

Single Solenoid
3-Way, 2-Position, NO (NP)

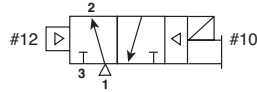

Normally Open:

De-energized position – Solenoid #10 de-energized. Pressure at inlet port 1 connected to outlet port 2, exhaust port 3 is blocked.

Energized position – Solenoid #10 energized. Pressure at inlet port 1 blocked, outlet port 2 connected to exhaust port 3.

Double Solenoid
3-Way, 2-Position

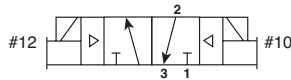

Solenoid operator #12 energized last. Pressure at inlet port 1 connected to outlet port 2, exhaust port 3 is blocked.

Solenoid operator #10 energized last. Pressure at inlet port 1 blocked, outlet port 2 connected to exhaust port 3.

Single Remote Pilot
3-Way, 2-Position, NC (NNP)

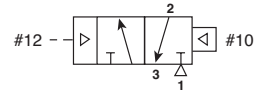

Normally Closed:

Normal position – Pressure at inlet port 1 blocked, outlet port 2 connected to exhaust port 3.

Operated position – Maintained air signal at port 12. Pressure at inlet port 1 connected to outlet port 2, exhaust port 3 is blocked.

Single Remote Pilot
3-Way, 2-Position, NO (NP)

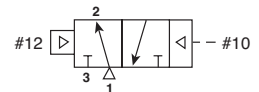

Normally Open:

Normal position – Pressure at inlet port 1 connected to outlet port 2, exhaust port 3 is blocked.

Operated position – Maintained air signal at port 10. Pressure at inlet port 1 blocked, outlet port 2 connected to exhaust port 3.

Double Remote Pilot
3-Way, 2-Position

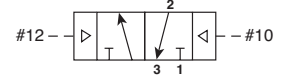

Momentary air signal at port 12 last. Pressure at inlet port 1 connected to outlet port 2, exhaust port 3 is blocked.

Momentary air signal at port 10 last. Pressure at inlet port 1 blocked, outlet port 2 connected to exhaust port 3.



Double Solenoid / Remote Pilot
Dual 3-Way, 2-Position NC / NC (NNP)

With #14 & #12 operators both de-energized – pressure at inlet port 1 blocked, outlet port 4 connected to exhaust port 5, outlet port 2 connected to exhaust port 3.

With #14 operator energized – pressure at inlet port 1 connected to outlet port 4, exhaust port 5 blocked, outlet port 2 connected to exhaust port 3.

With #12 operator energized – pressure at inlet port 1 connected to outlet port 2, exhaust port 3 blocked, outlet port 4 connected to exhaust port 5.

With #14 & #12 operators both energized – pressure at inlet port 1 connected to outlet ports 4 & 2, exhaust ports 3 & 5 blocked.

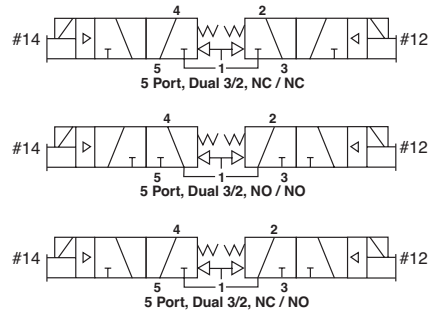

Dual 3/2 valves replace 3-position valves for better performance

3-position center exhaust

A traditional 5/3 center exhaust valve is now replaced by a double 3/2 NC+NC valve module. Both cylinder chambers are exhausted and rod and piston are free to move.

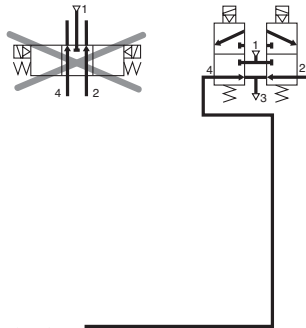

3-position pressure center

A traditional 5/3 pressure center valve is now replaced by a double 3/2 NO+NO valve module. The function is identical.

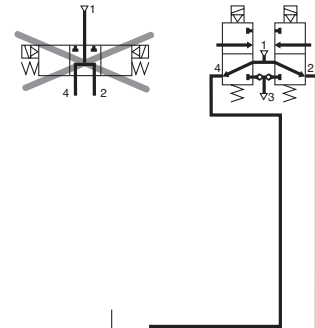

A
Product Index
Engineering Data
Product Index
Engineering Data

Lever Valves – Parallel & Perpendicular Operated

2-Position, Spring Return

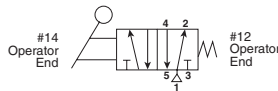

Single Pressure at Port #1 – The Hand Lever alternately pressurizes port 2 or 4 while exhausting at port 3 or 5. When actuating Hand Lever, port 4 is pressurized; when releasing Hand Lever, spring returns the spool, pressurizing port 2.

Dual Pressure – Pressure at port 3 & 5 alternately pressurizes port 2 or 4 while exhausting at port 1. When actuating Hand Lever, port 2 is pressurized; when releasing Hand Lever, spring returns the spool, pressurizing port 4. (Must be ordered as dual pressure)

2-Position, Detent

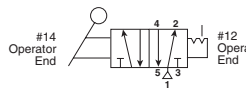

Single Pressure at Port #1 – The Hand Lever alternately pressurizes port 2 or 4 while exhausting at port 3 or 5. When pulling Hand Lever, port 4 is pressurized; when pushing Hand Lever, port 2 is pressurized. Spool stays in last actuated position.

Dual Pressure – Pressure at port 3 & 5 alternately pressurizes port 2 or 4 while exhausting at port 1. When pulling Hand Lever, port 2 is pressurized; when pushing Hand Lever, port 4 is pressurized. Spool stays in last actuated position. (Must be ordered as dual pressure.)

Foot Pedal Operated

2-Position, Spring Return

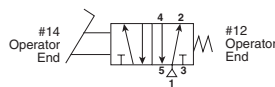

CAUTION:
 This valve shall not be used to actuate a punch press.
 Do not use this valve on punch presses or press brakes.
 See OSHA 1910.217.

See Dimension page for Pedal Guard Kit.

Single Pressure at Port #1 – The Foot Pedal alternately pressurizes port 2 or 4 while exhausting at port 3 or 5. When pressing Foot Pedal down, port 4 is pressurized; when releasing Foot Pedal, spring returns the spool, pressurizing port 2.

Dual Pressure – Pressure at port 3 & 5 alternately pressurizes port 2 or 4 while exhausting at port 1. When pressing Foot Pedal down, port 2 is pressurized; when releasing Foot Pedal, spring returns the spool, pressurizing port 4. (Must be ordered as dual pressure)

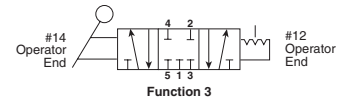

Function 3

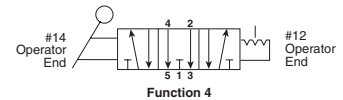

Function 4

3-Position, Detent

Single Pressure at Port #1 – The Hand Lever alternately pressurizes port 2 or 4 while exhausting at port 3 or 5. When pulling Hand Lever, port 4 is pressurized; when pushing Hand Lever, port 2 is pressurized. When Hand Lever is vertical, it is in the center position - either APB or CE. Spool stays in last actuated position.

Center Functions

All Ports Blocked – Function 3

Center Exhaust – Function 4

CAUTION:
 For 3-Position lever function, do not restrict exhaust ports with speed controls.



Electrical Enclosure IP Ratings

		2nd Numeral: Degree of protection with respect to harmful ingress of water								
		0	1	2	3	4	5	6	7	8
1st Numeral: Degree of Protection with respect to persons and solid objects	Non-Protected	0	Protected against dripping water	Protected against dripping water of ±15° angle	Protected against spraying water of ±60° angle	Protected against splashing water	Protected against water jets	Protected against heavy seas	Protected against immersion	Protected against submersion
	IP00	IP01	IP02							
	Protected against solid objects greater than Ø50mm	1	IP10	IP11	IP12	IP13				
	Protected against solid objects greater than Ø12mm	2	IP20	IP21	IP22	IP23				
	Protected against solid objects greater than Ø2.5mm	3	IP30	IP31	IP32	IP33	IP34			
	Protected against solid objects greater than Ø1.0mm	4	IP40	IP41	IP42	IP43	IP44	IP45	IP46	
	Dust protected Depression 200mm water column, air flow 80 x volume of enclosure	5					IP54	IP55	IP56	
Dust-tight Same test procedure	6						IP65	IP66	IP67	IP68

A

Product Index
Engineering Data

Product Index

Engineering Data

Functionality Explanation

Fluid Power		Universal Description		Electrical	
Function	Symbol			Function	Symbol
Normally Closed (N.C.)	2-Way	3-Way	Normally Non-Passing (NNP)	Normally Open (N.O.)	
Normally Open (N.O.)	2-Way	3-Way	Normally Passing (NP)	Normally Closed (N.C.)	



For inventory, lead times, and kit lookup, visit www.pdnplu.com



International Standards Organization

Crafted a set of rules you must follow to call your product an “ISO valve”.
In valves ISO standard identifies the pneumatic interface between valve and the base.
Defines pattern of mounting screws.
Allows products to be interchangeable between manufacturers.

15407-1

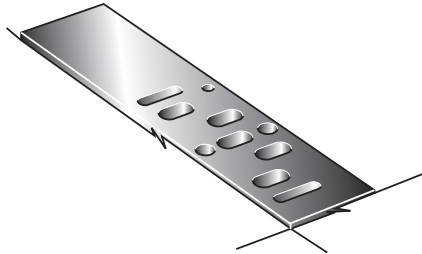

External Electrical Connection Subbase Valves

The ISO Standard 15407-1 specifies an interface pattern for a common subbase valve consisting of pressure passages 1, 3, 5, 2, & 4, pilot passages 12 & 14. The width of the pattern and location of the 2-bolt holes are also specified. This ISO standard specifies 2 different sizes – 18mm as the smallest and 26mm as the largest.

15407-2

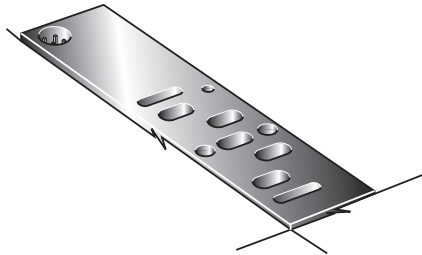

Body-to-Base Plug-In Subbase Valves

The ISO Standard 15407-2 specifies an interface pattern for a common subbase valve consisting of pressure passages 1, 3, 5, 2, & 4, pilot passages 12 & 14, and a plug-in electrical connector. The width of the pattern and location of the 2-bolt holes are also specified. This ISO standard specifies 2 different sizes – 18mm as the smallest and 26mm as the largest.

5599-1

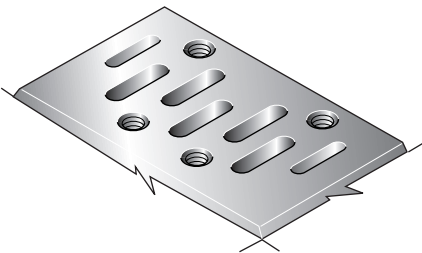

External Electrical Connection Subbase Valves

The ISO Standard 5599-1 specifies an interface pattern for a common subbase valve consisting of pressure passages 1, 3, 5, 2, & 4, and pilot passages 12 & 14. The width of the pattern and location of the 4 bolt holes are also specified. There are no specifications for the type of external electrical connection used to control the valve.

5599-2

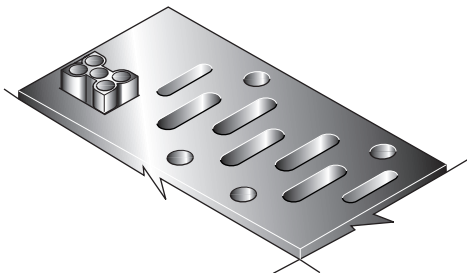

Body-to-Base Plug-In Subbase Valves

The ISO Standard 5599-2 specifies an interface pattern for a common subbase valve consisting of pressure passages 1, 3, 5, 2, & 4, pilot passages 12 & 14, and a plug-in electrical connector. The width of the pattern and location of the 4-bolt holes are also specified. This ISO standard specifies 6 different sizes – 1 as the smallest up to 6 as the largest. Manufacturers who produce ISO 5599-2 valves typically offer sizes 1, 2 & 3.



Pneumatic Valve Products
Direct Acting Valve Series

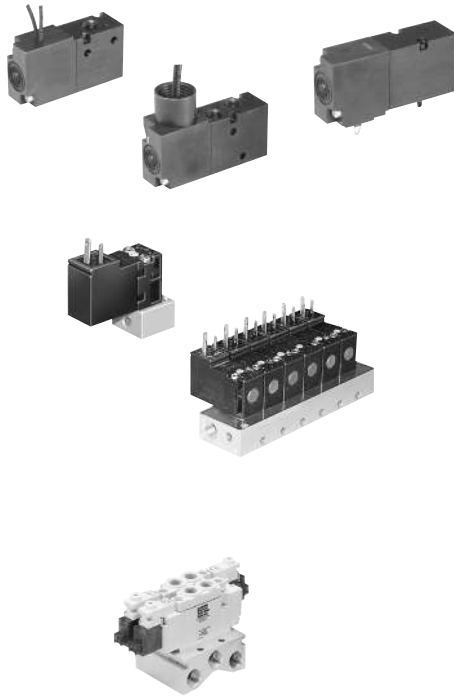

XM Series

Features	B1
Common Part Number / Ordering Information	B3-B5
Accessories	B6
Technical Data	B7
Dimensional Data	B8

15mm Solenoid Valve

Features	B9
Ordering Information	B10-B11
Dimensional Data	B11

A00 Solenoid Valve

Features	B12
Common Part Numbers / Ordering Information	B13
Accessories	B13
Technical Data	B14
Dimensional Data	B15

B

Direct Acting Valves



Features

XM Valve Series

XM series is a 1/8 inch ported, 3-way and 4-way, 2-position, spring return, normally open or normally closed, general purpose air valve.

Ports

- 1/8" NPT

Mounting

- Inline
- IEM bar manifold
- Subbase valve manifold

Solenoids

- Continuous duty rated
- 24" grommet
- 15mm 3-pin (9.4mm pin spacing)
- 1/2" conduit
- 12VDC to 240VAC

Balanced poppet

- 3-way N.O. & N.C.
- Diverter
- Selector
- Vacuum option

ROHS compliant

Material specifications

Body	Aluminum
Center post and armature	Stainless steel
Stem	Brass
Spring	Stainless steel
Seals	Buna N
Center post sleeve	Acetal
Coil	General purpose Class B, encapsulated

Performance information

Code	Electrical			Power Consumption (W / VA)	Holding Current (Amps)	Flow	
	Voltage		Cv Chart			3-Way	4-Way
	AC	DC					
	60Hz	50Hz					
42	24	22	—	4.8VA	.200	.15	.15
45*	—	—	12	4.5W	.375	.15	.15
49	—	—	24	4.5W	.188	.15	.15
53	120	110	—	4.32VA	.036	.15	.15
57	240	220	—	4.32VA	.018	.15	.15

* Mobile voltage, +25/-30%
 Note: Voltage tolerance: +10 / -15%
 Cv tested per ANSI / (NFPA) T3.21.3

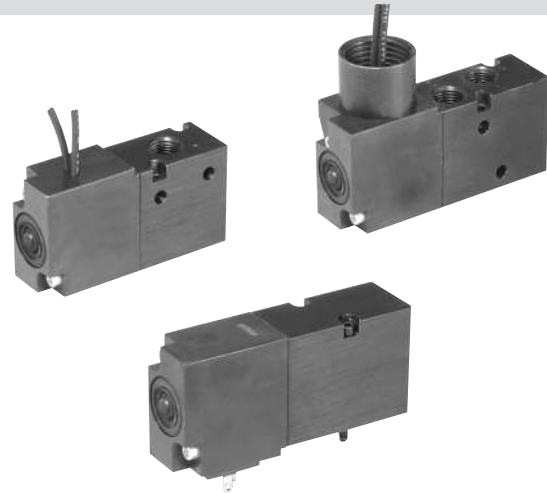

Operating information

3-way, N operating pressure:	0 to 125 PSIG
3-way, V* operating pressure:	28" Hg to 25 PSIG
4-way, N operating pressure:	28" Hg to 125 PSIG
Temperature range:	32°F to 125°F (0°C to 50°C)

* For vacuum service

Response time

Code	Voltage	0 Cu. In. Test Chamber		12 Cu. In. Test Chamber	
		Fill	Exhaust	Fill	Exhaust
49	24VDC	.011	.007	.240	.384
53	120VAC	.011	.020	.240	.384







Average Fill Time (Seconds): With 100 PSIG supply, time required to fill from 0-90 PSIG and exhaust from 100 PSIG to 10 PSIG is measured from instant of energizing, or de-energizing solenoid. Times shown are average.
 Tested per ANSI / (NFPA) T3.21.8.

B
 Direct Acting Valves
 XM Series
 15mm Solenoid Valves
 A00 Solenoid Valve







For inventory, lead times, and kit lookup, visit www.pdnplu.com

3-way Inline Valves

	Symbol	Port Size	Cv	Voltage	Valve Type	Weight	Part Number
		1/8"	.15	24" Grommet, 24VDC	Inline	4 oz	XM30NBG49A
		1/8"	.15	24" Grommet, 120VAC	Inline	(.11 Kg)	XM30NBG53A
		1/8"	.15	3-Pin, 15mm, DIN 9.4mm, 24VDC	Inline	4 oz	XM30NB549A
		1/8"	.15	3-Pin, 15mm, DIN 9.4mm, 120VAC	Inline	(.11 Kg)	XM30NB553A
		1/8"	.15	1/2" Conduit / 24" leads, 24VDC	Inline	5 oz	XM30NBH49A
		1/8"	.15	1/2" Conduit / 24" leads, 120VAC	Inline	(.14 Kg)	XM30NBH53A

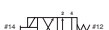

Note: All units with non-locking flush override. Can be used as N.O / N.C. / Diverter / Selector function.

4-way Inline Valves

	Symbol	Port Size	Cv	Voltage	Valve Type	Weight	Part Number
		1/8"	.15	24" Grommet, 24VDC	Inline	4.3 oz	XM40NBG49A
		1/8"	.15	24" Grommet, 120VAC	Inline	(.12 Kg)	XM40NBG53A
		1/8"	.15	3-Pin, 15mm, DIN 9.4mm, 24VDC	Inline	4.3 oz	XM40NB549A
		1/8"	.15	3-Pin, 15mm, DIN 9.4mm, 120VAC	Inline	(.12 Kg)	XM40NB553A
		1/8"	.15	1/2" Conduit / 24" leads, 24VDC	Inline	5.3 oz	XM40NBH49A
		1/8"	.15	1/2" Conduit / 24" leads, 120VAC	Inline	(.15 Kg)	XM40NBH53A

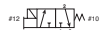

Note: All units with non-locking flush override.

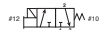
3-way Subbase Mount Valves

	Symbol	Port Size	Cv	Voltage	Valve Type	Weight	Part Number
		1/8"	.15	24" Grommet, 24VDC	Subbase mount	4 oz	XM3VNBG49A
		1/8"	.15	24" Grommet, 120VAC	Subbase mount	(.11 Kg)	XM3VNBG53A
		1/8"	.15	3-Pin, 15mm, DIN 9.4mm, 24VDC	Subbase mount	4 oz	XM3VNB549A
		1/8"	.15	3-Pin, 15mm, DIN 9.4mm, 120VAC	Subbase mount	(.11 Kg)	XM3VNB553A

Note: All units with non-locking flush override. Can be used as N.O / N.C. / Diverter / Selector function.

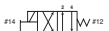
4-way Subbase Mount Valves

	Symbol	Port Size	Cv	Voltage	Valve Type	Weight	Part Number
		1/8"	.15	24" Grommet, 24VDC	Subbase mount	4.3 oz	XM4VNBG49A
		1/8"	.15	24" Grommet, 120VAC	Subbase mount	(.12 Kg)	XM4VNBG53A
		1/8"	.15	3-Pin, 15mm, DIN 9.4mm, 24VDC	Subbase mount	4.3 oz	XM4VNB549A
		1/8"	.15	3-Pin, 15mm, DIN 9.4mm, 120VAC	Subbase mount	(.12 Kg)	XM4VNB553A

Note: All units with non-locking flush override.

 Most popular.

B

Direct Acting Valves

XM Series

15mm Solenoid Valves

A00 Solenoid Valve



For inventory, lead times, and kit lookup, visit www.pdnplu.com

Model Number Index

B
 Direct Acting Valves
 XM Series
 15mm Solenoid Valves
 A00 Solenoid Valve

XM 4 0 N B G49 - A

Operator / Function	
3-Way, Direct Operated, Single Solenoid, Spring Return	3
4-Way, Direct Operated, Single Solenoid, Spring Return	4

Port Size / Thread Type	
1/8" NPT Inline	0*
Subbase Valve Less Base	V

* Available on IEM manifolds.

Pilot Source / Exhaust	
Direct Operated / Standard Pressure	N*
Direct Operated / Vacuum Service	V**

* 3-Way Valve Positive Pressure,
 4-Way Valve Vacuum or Positive Pressure
 ** 3-Way Valve Vacuum Pressure.

Overrides	
Flush - Non-Locking	B

Engineering Level	
A	Current

Options	
Blank	None
F0*	Flow Control

* 4-Way Valves Only.

Enclosures / Lead Length				
		Voltage		
		AC		DC
		60Hz	50Hz	
542	15mm 3-Pin DIN 9.4mm	24	22	
545*	15mm 3-Pin DIN 9.4mm			12
549	15mm 3-Pin DIN 9.4mm			24
553	15mm 3-Pin DIN 9.4mm	120	110	
G42	Grommet / Flying Leads 24"	24	22	
G45*	Grommet / Flying Leads 24"			12
G49	Grommet / Flying Leads 24"			24
G53	Grommet / Flying Leads 24"	120	110	
G57	Grommet / Flying Leads 24"	240	220	
H42 [†]	1/2" Conduit / Flying Leads 24"	24	22	
H45 ^{††}	1/2" Conduit / Flying Leads 24"			12
H49[†]	1/2" Conduit / Flying Leads 24"			24
H53[†]	1/2" Conduit / Flying Leads 24"	120	110	

* Mobile Voltage Rated.
[†] Inline Version Only.

Notes:
Inline Valves
 Conduit Inline valves cannot be mounted to IEM or Sub-base Manifolds.



For inventory, lead times, and kit lookup, visit www.pdnplu.com

How to Order Manifold Assemblies

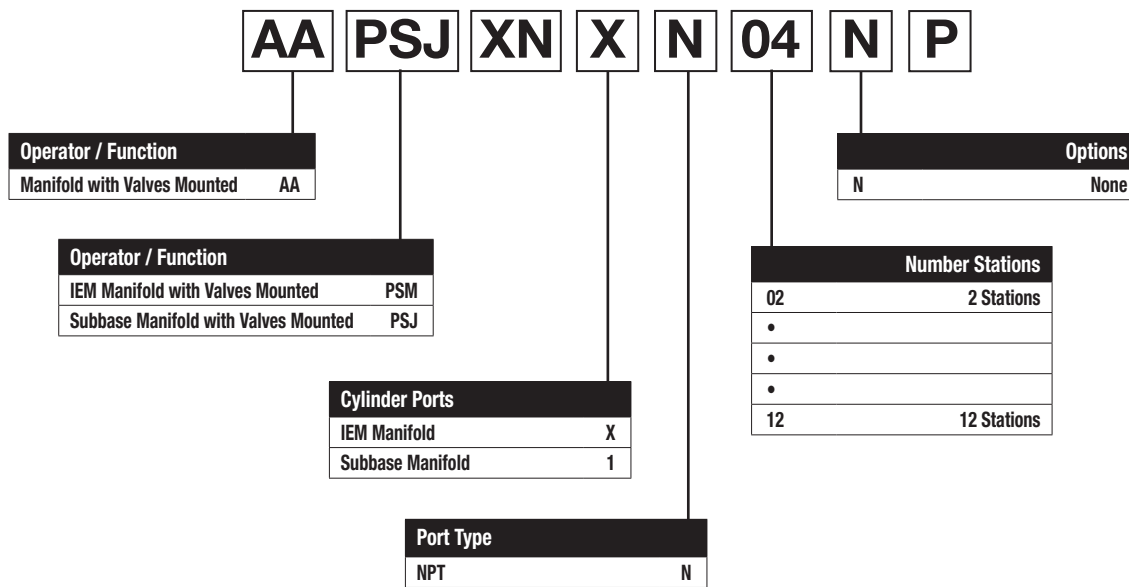

IEM Bar Manifold Assembly

First line item describes IEM Assembly. Subsequent line items listed identify each station in the Manifold starting with Station Number 1.

Ordering Example

Item	Qty	Part Number
001	1	AAPSMXNXN04NP
002	2	XM30NBG49A - Station 1, 2 - Normally Closed
003	1	XM40NBG49A - Station 3
004	1	XM40NBG49F0A - Station 4

Notes: When ordering Add-A-Folds, list valves left to right when looking at the Port 1/3 side of the manifold. All 3-Way valves will be assembled as 3-Way N.C. valves.

Component Ordering Example

Item	Qty	Part Number
001	1	PSMXNXN04NP (IEM Kit)
002	2	XM30NBG49A (Valve)
003	1	XM40NBG49A (Valve)
004	1	XM40NBG49F0A (Valve)

Subbase Manifold Assembly

First line item describes Subbase Assembly. Subsequent line items listed identify each station in the Manifold starting with Station Number 1.

Ordering Example

Item	Qty	Part Number
001	1	AAPSJXN1N04NP
002	2	XM3VNBG49A - Station 1, 2 - Normally Closed
003	1	XM4VNBG49A - Station 3
004	1	XM4VNBG49F0A - Station 4

Notes: When ordering Add-A-Folds, list valves left to right when looking at the Port 2/4 side of the manifold. All 3-Way valves will be assembled as 3-Way N.C. valves. Isolator Discs are required for N.O. functions.

Component Ordering Example

Item	Qty	Part Number
001	1	PSXM31010P (End Plate Kit)
002	4	PSXM530CP (Subbase Kit)
003	2	XM3VNBG49A (Valve)
004	1	XM4VNBG49A (Valve)
005	1	XM4VNBG49F0A (Valve)

B

Direct Acting Valves

XM Series

15mm Solenoid Valves

A00 Solenoid Valve



For inventory, lead times, and kit lookup, visit www.pdnplu.com

Accessories

Manifold



Description	Part Number
IEM bar manifold (NPT)	PSMXNXN##NP

- stations 02 to 12 (04 Shown)

Subbase



Description	Part Number
Manifold subbase kit (NPT)	PSXM530CP

Plug-in Electrical Connectors - 9.4mm



Description	Indication	Voltage	Part Number
Unwired Plug	None	N/A	PESC10
	LED &	12/24V	PESC2020B
	Suppression	120VAC	PESC2001F

IEM Bar Manifold Assembly



IEM Bar Manifold allows for mounting of 3-Way and 4-Way Inline valves on the same manifold. 3-Way Valves can be mounted on the same manifold to provide a Normally Closed or Normally Open function by rotating the valves 180°. 4-Way valves can be mounted with or without Flow Controls.

IEM Bar Manifold Assemblies consist of valves and an IEM Manifold. Valves and IEM Manifold can be ordered separately.

Accessories



Description	Part Number
End plate kit (NPT)	PSXM31010P



Description	Part Number
Blanking plate kit	PSXM8310P
Subbase Kit includes: (1) Plate, (3) Screws, (4) Gaskets	
Fits subbase or IEM type manifold.	



Description	Part Number
Mounting Bracket - Inline valve	PSXM8288P



Description	Part Number
Isolator plugs - Subbase manifold	PSXM40900P



Description	Part Number
IEM valve / manifold o-ring kit	PSXM2186P



Description	Part Number
Subbase valve / manifold bolt kit	PSXM8100P

Subbase Manifold Assembly



Subbase Manifold allows for mounting of 3-Way and 4-Way Subbase Valves can be mounted on the same manifold. 3-Way Valves can be mounted on the same manifold to provide a Normally Closed or Normally Open function through the use of port isolation kits. 4-Way valves can be mounted with or without Flow Controls.

Subbase Manifold Assemblies consist of Valves, End Plate Kit and Manifold Subbase Kits. Valves, End Plate Kit and Manifold Subbase Kits can be ordered separately.

B

Direct Acting Valves

XM Series

15mm Solenoid Valves

A00 Solenoid Valve

Inline Valve on IEM Bar Manifold Assembly

IEM Bar Manifold Assembly's are assembled by adding Inline Valves to an IEM Bar Manifold. O-rings are installed at each valve station in the counterbore on the top of the manifold. Valves are installed with 2 mounting screws. For 3-Way N.C. valve operation, line up the solenoid end of the Valve with Port 1 on the Manifold. For 3-Way N.O. operation, line up the solenoid end of the valve with Port 3 on the manifold. For 4-Way valve operation, line up the Solenoid end of the valve with Port 1 on the manifold. If manifolds are factory assembled, all 3-Way valves are N.C. To convert from N.C. to N.O. operation, remove valve from the base and place valve 180° from the original position with the solenoid end lined up with the 3-Port on the manifold.

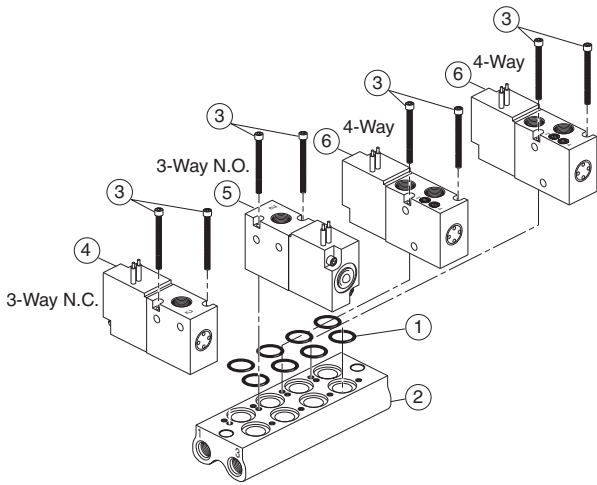

Subbase Valve and Manifold Assembly

Subbase Manifold Assembly's are assembled by adding tie rods and manifold bases to the end plate kit of the subbase end plate kit as shown below. Valves are added to each subbase per manifold design. 4-Way and 3-Way valves are mounted with Solenoids Coils facing away from subbase delivery ports 2 and 4. For 3-Way N.O. Functions, valves must be isolated from the other 3-Way N.C. and 4-Way valves on the manifold. This is achieved by placing port isolator discs in between the subbase of the first 3-Way N.O. Valve and the subbase of the last 3-Way N.C. or 4-Way valve in the Subbase Manifold. Inlet pressure is connected to Port 3 of the manifold for the 3-Way N.O. valves. Inlet pressure is connected to the Port 1 of the manifold for the 3-Way N.C. and 4-Way valves. Separate Inlet Pressure Ports and Exhaust Ports are required for N.O. and N.C. 3-way function valves.

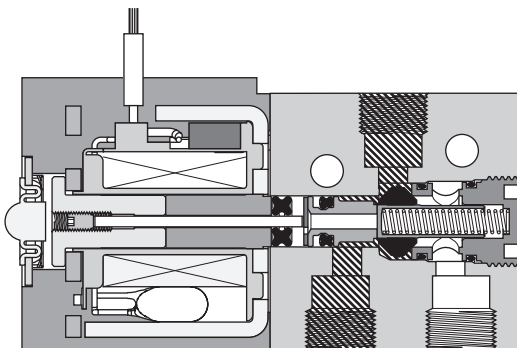
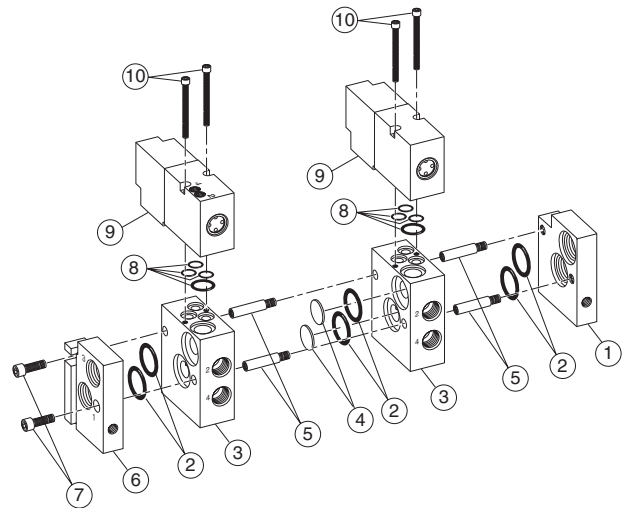

3-Way Inline Valve
 Shown Energized

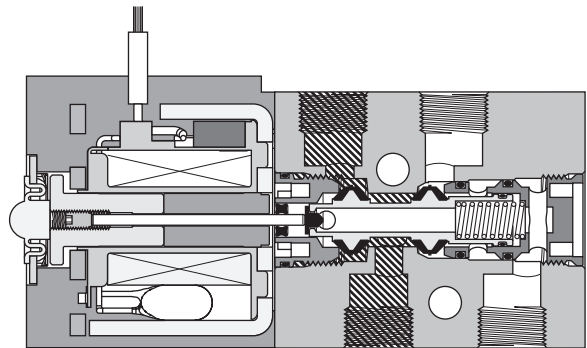

4-Way Inline Valve
 Shown De-Energized

Pressure Exhaust



For inventory, lead times, and kit lookup, visit www.pdnplu.com

XM 3-way Inline

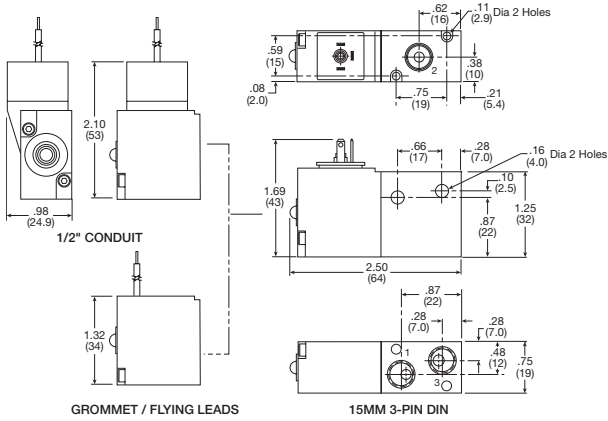

Inches (mm)
 Note: 22 AWG black cross linked polyethylene insulated lead wire.

XM 4-way Inline

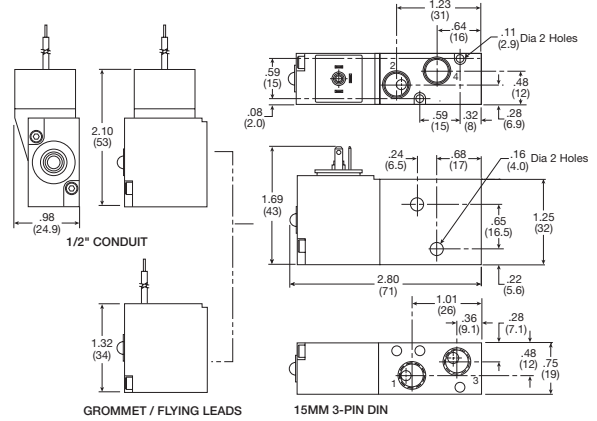

Inches (mm)
 Note: 22 AWG black cross linked polyethylene insulated lead wire.

XM 4-way Inline with Flow Controls

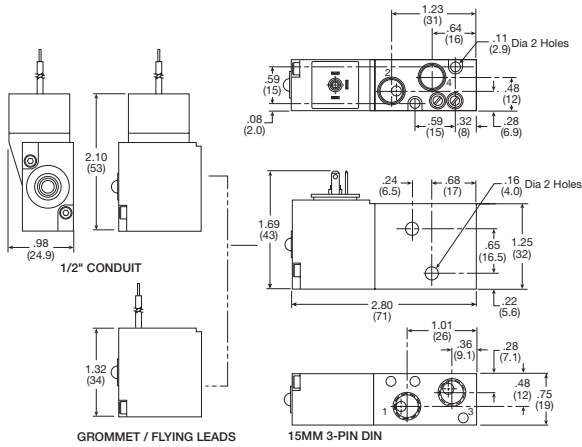

Inches (mm)
 Note: 22 AWG black cross linked polyethylene insulated lead wire.

XM IEM Manifold

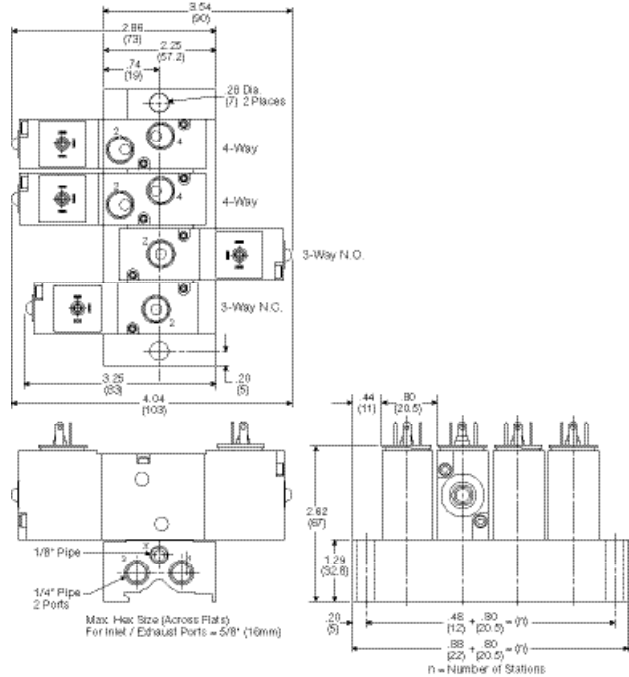

XM IEM Subbase

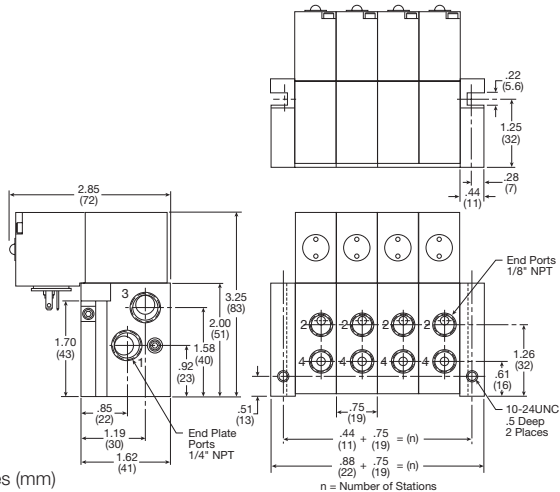

Inches (mm)

Mounting Bracket Dimensions

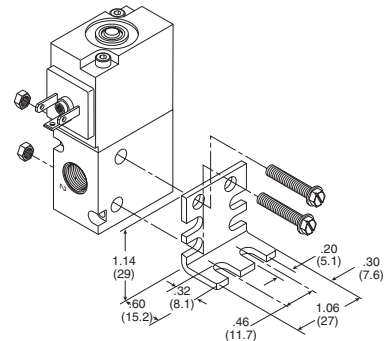

B
 Direct Acting Valves
 XM Series
 15mm Solenoid Valves
 A00 Solenoid Valve



For inventory, lead times, and kit lookup, visit www.pdnplu.com

Features

15mm Solenoid Valve

A compact 15mm, 3-way subbase or manifold mounted valve. Ideally suited for use in stationary or mobile equipment applications, where flow rates and low temperatures are a key consideration.

Features

- Compact and simple design
- Utilizes 15mm solenoid operators
- Manifold allows mounting of normally open and normally closed operators simultaneously
- Up to 20 stations available

Solenoids

- 15mm low watt solenoids are UL certified and approved to be CE marked
- Wide range of voltages available

Applications

- Piloting for process control valves
 - pharmaceutical equipment
 - waste water treatment systems
 - food processing
 - chemical batching
- Industrial laundry equipment
- Paint spray & dyeing equipment
- Textile winding applications
- Vacuum and conveyor applications

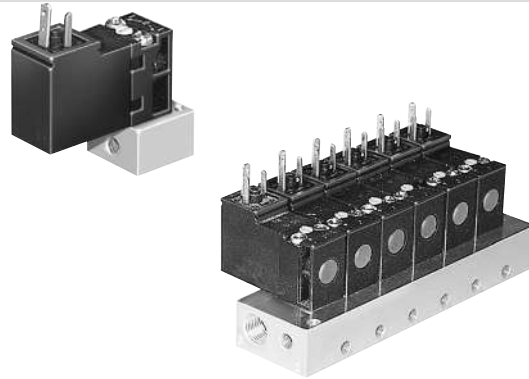

Operating information

Operating pressure:	Vacuum to 145 PSIG (Vacuum to 10 bar)
Operating temperature:	
Standard Flow:	5°F to 140°F (-15°C to 60°C)
High Flow:	5°F to 122°F (-15°C to 50°C)
Mobile Applications (47 & 48 Voltage Options):	-40°F to 158°F (-40°C to 70°C)
Storage temperature:	
All applications:	-40°F to 158°F (-40°C to 70°C)

Material specifications

Body	Glass filled polyamide
Internal metal parts	Steel
Screws	Steel
Bottom plug	Thermoplastic
Poppet seals	Nitrile for standard, fluorocarbon for mobile

Technical data

Electrical interface per:	DIN 43650 Form C (EN175301-803C) 8mm pin spacing
Pneumatic interface per:	AFNOR E 0652 110 N
Protection:	IP65 (Washdown)
Air flow:	Standard flow 0.033 Cv (33 Lpm) (1.2W) (1.6VA)
Voltage tolerance:	All voltages except 47 & 48: Rated voltage +10% / -15% options 47 & 48: Rated voltage +25% / -30%

Manifold - Pins Down

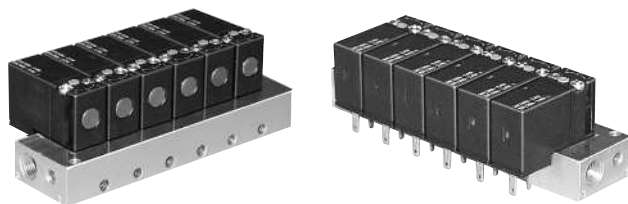

Manifold - Pins Up

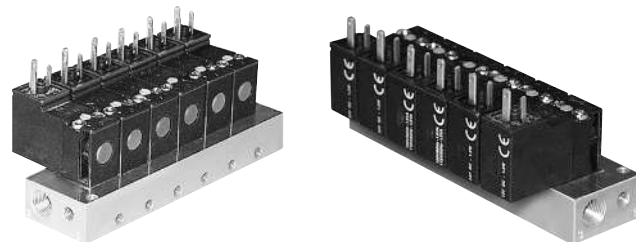

B

Direct Acting Valves

XM Series

15mm Solenoid Valves

A00 Solenoid Valve



For inventory, lead times, and kit lookup, visit www.pdnplu.com

Ordering Information

15mm Solenoid Kit Information

3/2 Normally Non-passing (NNP) /
Normally Closed (NC) Valves

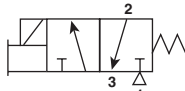

3/2 Normally Passing (NP) /
Normally Open (NO) Valves

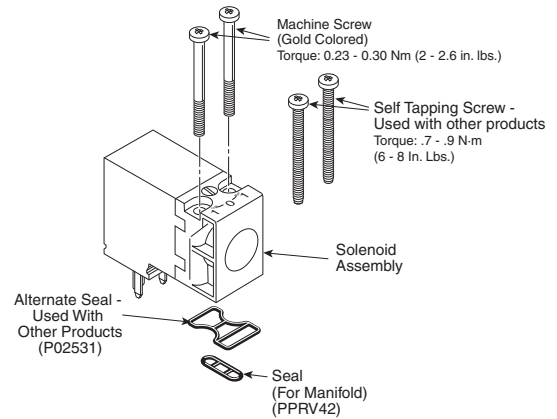
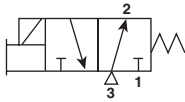

NC (NNP) Solenoids / Kits

	## Voltage (S = Standard, O = Optional, — = N/A)					
* Override	42 (24VAC)	45 (12VDC)	49 (24VDC)	53 (120VAC)	57 (230VAC)	Kit No.
B (Non-lock, Flush)	O	O	S	S	O	PS2982*##P Pins: UP NC / NNP 1.2W / 1.6VA
C (Lock, Flush)	O	O	S	S	O	
D (Non-lock, Ext)	—	—	O	O	—	
B (Non-lock, Flush)	O	O	S	S	—	PS3541*##P Pins: DOWN NC / NNP 1.8W / 2.4VA
C (Lock, Flush)	O	O	S	S	—	
D (Non-lock, Ext)	—	—	O	O	—	
E (Lock, Ext)	—	—	O	O	—	
B (Non-lock, Flush)	O	O	O	O	O	PS3441*##P Pins: DOWN NC / NNP 1.2W / 1.6VA
C (Lock, Flush)	O	O	O	O	O	
B (Non-lock, Flush)	—	O	S	S	—	PS3202*##P Pins: UP NO / NP 1.2W / 1.6VA

* Override, ## Voltage

Female Electrical Connectors

15mm 3-Pin DIN 43650C (Use with enclosure "5")

Description		Connector	Connector with Cord
Unlighted	18 Inches	PS2932BP	PS2932HBP
Unlighted	6 Feet	PS2932BP	PS2932JBP
Light - 12VAC or DC	6 Feet	PS294675BP	PS2946J75BP*
Light - 24VAC or DC	6 Feet	PS294679BP	PS2946J79BP*
Light - 110/120VAC	6 Feet	PS294683BP	PS2946J83BP*
Light - 240/230VAC		PS294687BP	N/A

* LED with surge suppression.

Note: Max ø6.5mm cable size required for connector w/o 6' (2m) cord.
IP65 rated when properly installed.

Engineering Data:

- Conductors: 2 poles plus ground
- Cable range (Connector only): 4 to 6mm (0.16 to 0.24 Inch)
- Contact spacing: 8mm

☐ Most popular.

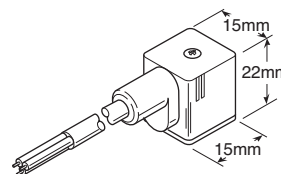

Connector with cord

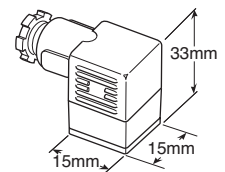

Connector only



For inventory, lead times, and kit lookup, visit www.pdnplu.com

Model Number Index

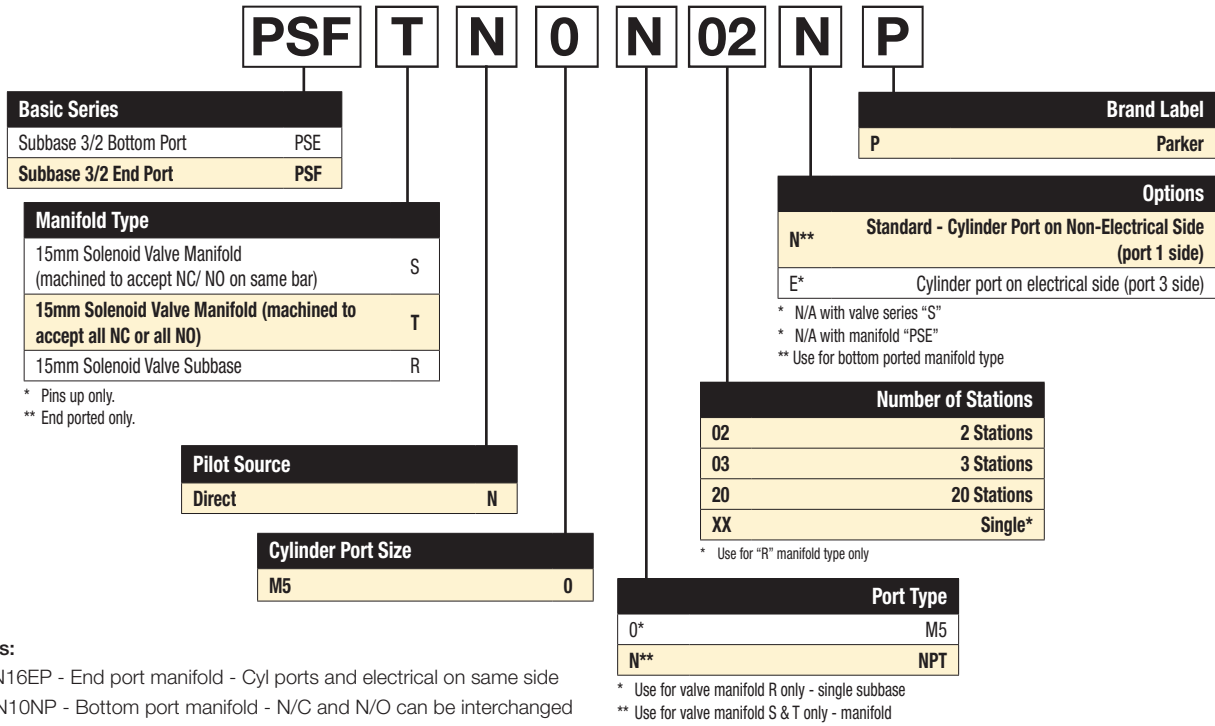

Examples:

PSFTNON16EP - End port manifold - Cyl ports and electrical on same side
 PSESNON10NP - Bottom port manifold - N/C and N/O can be interchanged
 PSFTNON10NP - End port manifold - Cyl ports and electrical are opposite

Manifold Dimensions

Special mounting considerations must be made for connector assembly clearance when mounting solenoid valves with pins down.

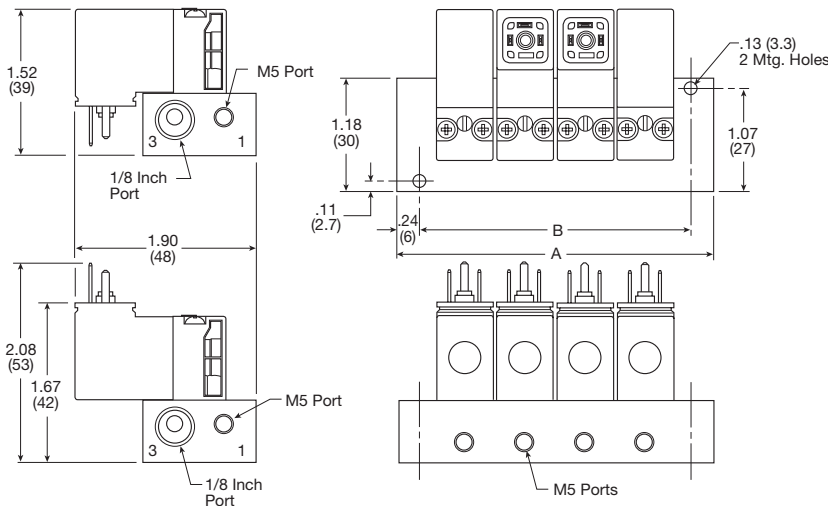

Number of Stations	Dim. A	Dim. B
2	2.04 (52)	1.57 (40)
3	2.68 (68)	2.20 (56)
4	3.31 (84)	2.83 (72)
5	3.94 (100)	3.46 (88)
6	4.57 (116)	4.09 (104)
7	5.20 (132)	4.72 (120)
8	5.83 (148)	5.35 (136)
9	6.46 (164)	5.98 (152)
10	7.09 (180)	6.61 (168)
11	7.72 (196)	7.24 (184)
12	8.35 (212)	7.87 (200)
13	8.98 (228)	8.50 (216)
14	9.61 (244)	9.13 (232)
15	10.23 (260)	9.76 (248)
16	10.87 (276)	10.39 (264)
17	11.50 (292)	11.02 (280)
18	12.13 (308)	11.65 (296)
19	12.76 (324)	12.28 (312)
20	13.39 (340)	12.91 (328)

Subbase Dimensions

Pins up only.

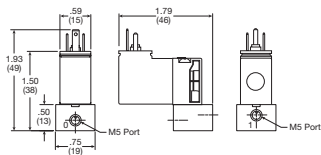

Most popular.

15mm Solenoid Dimensions

Pins up only.

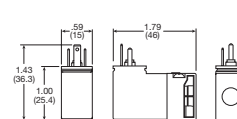

For inventory, lead times, and kit lookup, visit www.pdnplu.com

ADEX Solenoid Valve

ADEX A00 Valve is miniature low power direct acting 3-way solenoid valve. A00 can be used in piloting or low flow vacuum applications.



Features

- Fast response < 10ms

Ports

- A00: M3 – .01 Cv

Mounting

- Subbase mount

Solenoids

- 0.6 W
- 12VDC and 24VDC
- LED and surge suppression

Operating information

Maximum operating pressure*:

A00 (NC) Vacuum to 100 PSIG (Vacuum to 6.8 bar)

A00 (NO) Vacuum to 70 PSIG (Vacuum to 4.8 bar)

Minimum operating pressure: See chart below

Operating temperature:

Intermittent Duty (AC & DC Voltage): 32°F to 122°F (0°C to 50°C)
Voltage Rated +10 / -10%

Continuous Duty (DC Voltage Only): 32°F to 104°F (0°C to 40°C)
Voltage Rated +0 / -10%

* When using vacuum and pressure simultaneously on ports 1 & 3, normally closed valve, the maximum pressure is 85 PSIG (586 kPa).

When using vacuum and pressure simultaneously on ports 1 & 3, normally open valve, the maximum pressure is 58 PSIG (400 kPa).

Material specifications

Body	Anodized aluminum
End caps	Anodized aluminum
Coils	Thermoplastic
Fasteners	Stainless steel
Spool	Aluminum and nitrile rubber

Minimum operating pressure

Description	Internal Pilot	
	PSIG	Bar
3-way A00 Series	Vacuum	

* When using vacuum and pressure on ports 1 & 3 – 85 PSIG (586 kPa) NC; 58 PSIG (400 kPa) NO.

B
 Direct Acting Valves
 XM Series
 15mm Solenoid Valves
 A00 Solenoid Valve

A00 Valve Only – Single Solenoid, 3-way, 2-position*



A00SC23-1P Shown
 * Screwdriver-Operated, Locking Manual Override (LMOR).

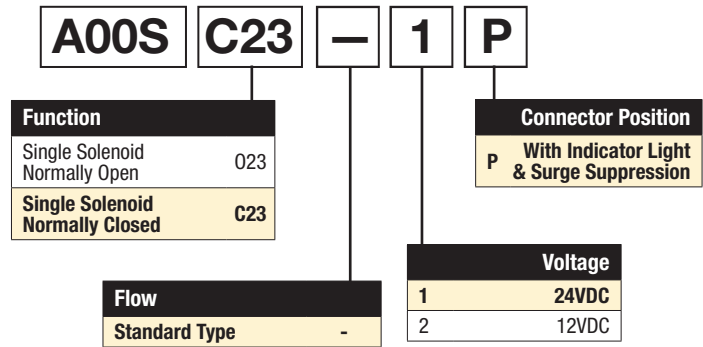

A00 Valve Subbase, M3 ports



Valve type	All Ports	Part number
A00	M3	A00S-B-M3

Mounting screws and gaskets included with valve.

A00 Valve Manifold*, M5 ports



MMFS6A00M5 Shown

* Normally closed valves (A00SC23•P) and Normally open valves (A00S023•P) cannot be mounted on the same manifold simultaneously.
 Mounting screws and gaskets included with valve.

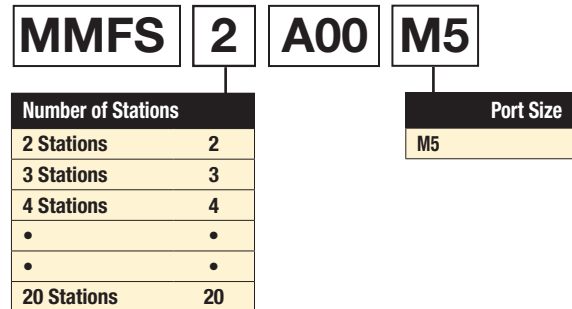

Individual Wired Connectors P / R Type

Size	Voltage	Length	Part Number
A00	DC	.5 meter	A05P-DC-CL5
		1 meter	A05P-DC-CL10
		3 meter	A05P-DC-CL30

DC Voltage: Positive "+" (Red Wire)
 Negative "-" (Black Wire)

Exhaust Mufflers



Pipe Thread	Part Number
M5	P6M-PAC5

P6M - Plastic; EM - Sintered Bronze

Replacement Base Gasket Kits

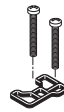

A00S-SG

Size	Type	Gasket & Screw Kit
A00	Subbase	A00S-SG

These are spare parts, mounting screws and gaskets included with valves.

Most popular.



For inventory, lead times, and kit lookup, visit www.pdnplu.com

Flow Rating (Cv)

Size	Port Size	Mounting Style	ANSI / (NFPA)
			2-Position
A00	M3	Subbase	.010

ANSI / (NFPA) T3.21.3-1990 standard for Cv measurement.

Response Time

Valve Size	Port Size	0 Cu. In. Test Chamber	
		Fill	Exhaust
2-Position Single Solenoid / Air Return			
A00	M3	.004	.006

Average Fill Time (Seconds): With 100 PSIG supply, time required to fill from 0-90 PSIG and exhaust from 100 PSIG to 10 PSIG is measured from instant of energizing, or de-energizing 24VDC solenoid. Times shown are average.

Tested per ANSI / (NFPA) T3.21.8.

Solenoid Information

Power Consumption	Standard		With Indicator Light & Surge Suppressor
	DC	W	
			0.6

ANSI Cv vs. JIS Cv

For Pneumatic Valve flow, the measurement **Cv** – Coefficient of Flow – is used to convey to the user how much air can flow through a given valve. Most valve manufacturers publish this information in their catalogs to assist the user in choosing the proper valve for their application. In publishing this data however, there are discrepancies in how the **Cv** is calculated, resulting in some **Cv**'s being **OVERSTATED** by **20 to 40%**. This can adversely affect the user's application because the valve flows **LESS** than the published **Cv**.

The reason for the large discrepancy is in the method of calculation - the ANSI (NFPA) or the JIS standard.

Parker's **Cv** valve is calculated using the ANSI (NFPA) T3.21.3-1990 standard. The ANSI (NFPA) method is a structured test using very specific tube sizes and lengths, inlet pressures and pressure drops, and volume chambers.

B
 Direct Acting Valves
 XM Series
 15mm Solenoid Valves
 A00 Solenoid Valve

Single Solenoid 3-Way, 2-Position NC

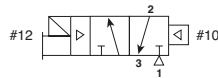

Vacuum Applications (Device becomes NO):

- '1' port is connected to atmosphere or compressed air † when required.
- '2' port is outlet
- '3' port is connected to vacuum

† When both vacuum and compressed air are required, maximum pressure is 85 PSIG (586 kPa).

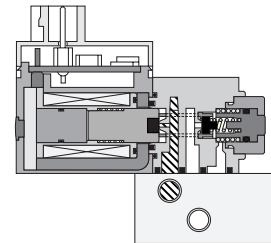

A00S Single Solenoid Normally Closed (NC)

Pressure Exhaust

Single Solenoid 3-Way, 2-Position NO*

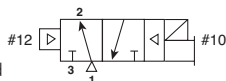

* To obtain NO function, ports 1 & 3 are reversed (1 becomes exhaust and 3 becomes supply).

Vacuum Applications (Device becomes NC):

- '1' port is connected to vacuum
- '2' port is outlet
- '3' port is connected to atmosphere or compressed air † when required.

† When both vacuum and compressed air are required, maximum pressure is 58 PSIG (400 kPa).

Caution: Normally Open and Normally Closed 3-Way valve cannot be mixed on the same manifold.



For inventory, lead times, and kit lookup, visit www.pdnplu.com

A00 Subbase

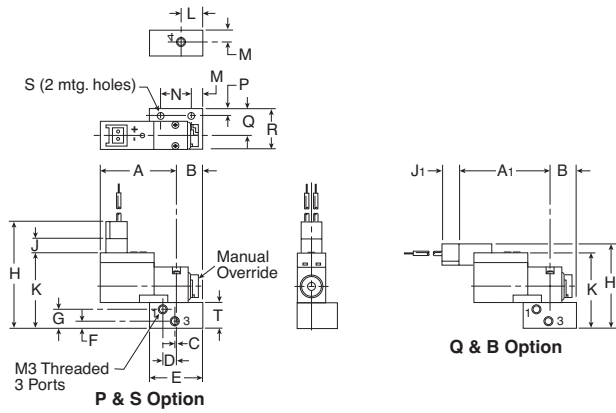

A00 - Subbase

A	A1	B	C	D
1.00 (25)	1.18 (30)	.41 (11)	.015 (.4)	.17 (4)
E	F	G	H	H1
.79 (20)	.12 (3)	.28 (7)	1.54 (39)	1.38 (34)
J	J1	K	L	M
.24 (6)	.20 (5)	1.11 (28)	.32 (8)	.18 (5)
N	P	Q	R	S
.47 (12)	.10 (3)	.39 (10)	.59 (15)	.106 (2.7)
T				
.38 (10)				

Inches (mm)

A00 Manifold

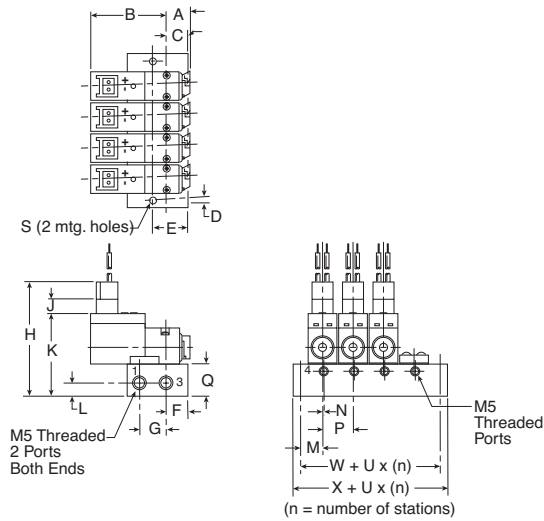

A00 - Manifold

A	B	C	D	E
.36 (9)	1.00 (25)	.31 (8)	.10 (3)	.51 (13)
F	G	H	J	K
.31 (8)	.39 (10)	1.63 (42)	.20 (5)	1.22 (31)
L	M	N	P	Q
.20 (5)	.33 (9)	.02 (.6)	.41 (10.5)	.47 (12)
S	U	X	W	
.125 (3.2)	.41 (10.5)	.45 (11.5)	.26 (6.5)	

Inches (mm)

B

Direct Acting Valves

XM Series

15mm Solenoid Valves

A00 Solenoid Valve

Pneumatic Valve Products
Inline Valve Series

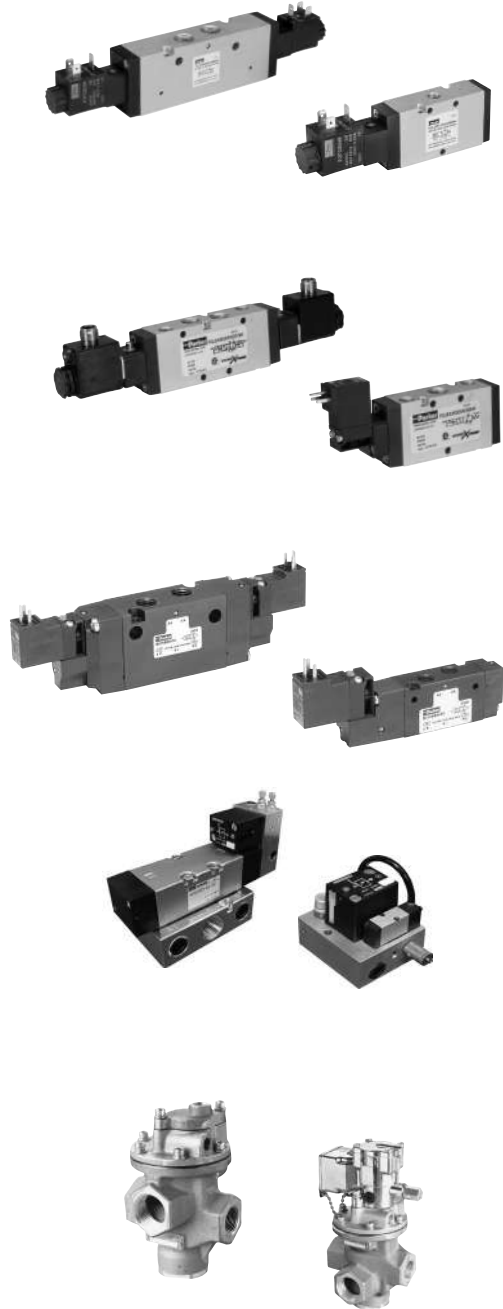

Viking Lite Series

Features	C2
Common Part Numbers / Ordering Information	C3-C5
Accessories	C6
Dimensional Data	C7-C10

Viking Xtreme Series

Features	C11
Common Part Numbers / Ordering Information	C12-C19
Accessories	C20-C23, C28-C30
Technical Data	C24-C27, C29
Dimensional Data	C30-C38

B3, B5 & B6 Series

Features	C39
Common Part Numbers / Ordering Information	C40-C45
Accessories	C46-C48
Technical Data	C49-C54
Dimensional Data	C55-C58

B7 & B8 Series

Features	C59
Common Part Numbers / Ordering Information	C60-C63
Accessories	C64-C66
Technical Data	C67-C69
Dimensional Data	C70-C73

Air Saver Series

Features	C72-C73
Specifications	C74
Ordering Information / Dimensional Data	C75-C80

N Series

Features	C81
Common Part Numbers / Ordering Information	C82-C85
Technical Data	C86-C91
Dimensional Data	C92-C99

C

Inline Valves



Viking Lite Series

The Viking Lite valve range is robust, versatile and combines a large flow capacity with short change-over times, designer may choose 1/8, 1/4 or 3/8 port sizes along with 24VDC and 120VAC voltage options. Viking Lite valves are fitted with dynamic bi-directional spool seals suitable for pressures up to 10 bar and ambient temperatures between -10°C to + 50°C. When in service, radial expansion of the spool seal occurs to maintain sealing contact with the valve bore. This sealing method reduces friction and produces a lower required pilot pressure. Valves do not require lubrication in operation but they can also be installed in systems that are lubricated.

Ports

- P2LAZ: 1/8 inch NPT & BSPP, Cv = 0.6
- P2LBZ: 1/4 inch NPT & BSPP, Cv = 1.5
- P2LCZ: 3/8 inch NPT & BSPP, Cv = 2.5

Mounting

- Inline
- IEM aluminum bar

Solenoids

2.5 watts
- 22mm, 3-pin (DIN 43650)
24VDC and 120VAC

• Certification / approval

- IP65 Rated, RoHS, CE

Materials

Valve body	Anodized aluminium
End covers	Anodized aluminium
Spool	Aluminium
Piston	Acetal plastic / Anodized aluminium
End cover seals	Nitrile rubber
End cover screws	Zinc plated steel
Springs	Stainless steel
Mounting screws for solenoid	Stainless steel
Spool seals	Nitrile

Features

WCS

- Maximum Performance
 - Low friction - fast response - less wear
- Long Cycle Life
 - Under pressure, radial expansion of the seal occurs to maintain sealing contact with the valve bore
- Non-Lube Service
 - No lubrication required for continuous valve shifting
- Bi-Directional Spool Seals
 - Common spool used for any pressure

- Solenoid operated, IP65, RoHS, CE
- 90° rotation

The bore is polished to a very high surface finish for maximum flow capacity and long life.

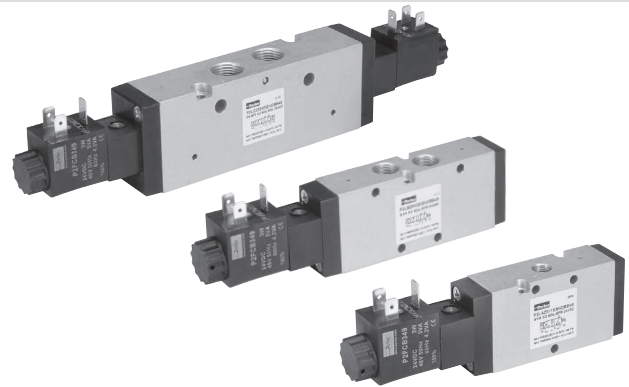
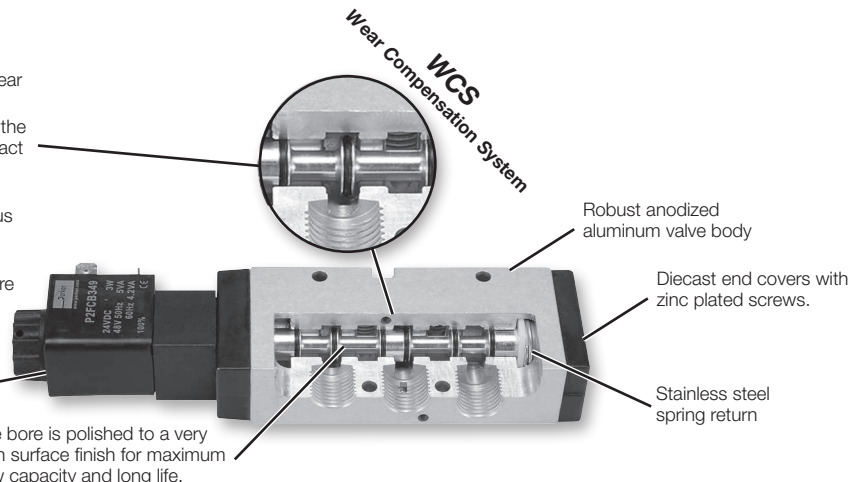

Operating information

Operating pressure: 145 PSIG (10 bar)
Minimum: See chart
Operating temperature: 14°F to 122°F (-10°C to 50°C)

Minimum operating pressure, PSIG (bar)

Valve type - Internal pilot	P2LAZ	P2LBZ	P2LCZ
Single solenoid - spring return	43.5 (3.0)	43.5 (3.0)	43.5 (3.0)
Single remote pilot - spring return	43.5 (3.0)	43.5 (3.0)	43.5 (3.0)
Double solenoid - 2-position	22 (1.5)	22 (1.5)	22 (1.5)
Double remote pilot - 2-position	22 (1.5)	22 (1.5)	22 (1.5)
Double solenoid - 3-position (APB, PC, CE)	43.5 (3.0)	43.5 (3.0)	43.5 (3.0)
Double remote pilot - 3-position (APB, PC, CE)	43.5 (3.0)	43.5 (3.0)	43.5 (3.0)

Recommended air quality for valves

For best possible service life and trouble free operation, ISO 8573-1 quality class 3.4.3 should be used. This means 5µm filter (standard filter) dew point +3°C for indoor operation (a lower dew point should be selected for outdoor operation) and oil concentration 1.0 mg oil/m³, which is what a standard compressor with a standard filter gives.

3/2 - 2-Position Single Solenoid, Non-locking Manual Override

Port size	Cv	Response Time (msec)	Weight lb (kg)	Voltage	Part Number	
					(NPT)	(BSPP)
1/8	0.6	15 / 35	0.35 (0.16)	24VDC	P2LAZ391ESNDBB49	P2LAZ311ESNDBB49
				120VAC	P2LAZ391ESNDBB53	P2LAZ311ESNDBB53
1/4	1.5	18 / 45	0.35 (0.16)	24VDC	P2LBZ392ESNDBB49	P2LBZ312ESNDBB49
				120VAC	P2LBZ392ESNDBB53	P2LBZ312ESNDBB53
3/8	2.5	27 / 45	0.77 (0.35)	24VDC	P2LCZ393ESNDBB49	P2LCZ313ESNDBB49
				120VAC	P2LCZ393ESNDBB53	P2LCZ313ESNDBB53

P2LAZ Shown

3/2 - 2-Position Double Solenoid, Non-locking Manual Override

Port Size	Cv	Response Time (msec)	Weight lb (kg)	Voltage	Part Number	
					(NPT)	(BSPP)
1/8	0.6	10 / 10	0.40 (0.18)	24VDC	P2LAZ391EENDBB49	P2LAZ311EENDBB49
				120VAC	P2LAZ391EENDBB53	P2LAZ311EENDBB53
1/4	1.5	12 / 12	0.40 (0.18)	24VDC	P2LBZ392EENDBB49	P2LBZ312EENDBB49
				120VAC	P2LBZ392EENDBB53	P2LBZ312EENDBB53
3/8	2.5	17 / 17	0.80 (0.36)	24VDC	P2LCZ393EENDBB49	P2LCZ313EENDBB49
				120VAC	P2LCZ393EENDBB53	P2LCZ313EENDBB53

P2LAZ Shown

5/2 - 2-Position Single Solenoid, Non-locking Manual Override

Port Size	Cv	Response Time (msec)	Weight lb (kg)	Voltage	Part Number	
					(NPT)	(BSPP)
1/8	0.6	15 / 35	.037 (0.17)	24VDC	P2LAZ591ESNDBB49	P2LAZ511ESNDBB49
				120VAC	P2LAZ591ESNDBB53	P2LAZ511ESNDBB53
1/4	1.5	18 / 45	0.44 (0.20)	24VDC	P2LBZ592ESNDBB49	P2LBZ512ESNDBB49
				120VAC	P2LBZ592ESNDBB53	P2LBZ512ESNDBB53
3/8	2.5	27 / 45	0.95 (0.43)	24VDC	P2LCZ593ESNDBB49	P2LCZ513ESNDBB49
				120VAC	P2LCZ593ESNDBB53	P2LCZ513ESNDBB53

P2LAZ Shown

5/2 - 2-Position Double Solenoid, Non-locking Manual Override

Port Size	Cv	Response Time (msec)	Weight lb (kg)	Voltage	Part Number	
					(NPT)	(BSPP)
1/8	0.6	10 / 10	.042 (0.19)	24VDC	P2LAZ591EENDBB49	P2LAZ511EENDBB49
				120VAC	P2LAZ591EENDBB53	P2LAZ511EENDBB53
1/4	1.5	12 / 12	0.46 (0.21)	24VDC	P2LBZ592EENDBB49	P2LBZ512EENDBB49
				120VAC	P2LBZ592EENDBB53	P2LBZ512EENDBB53
3/8	2.5	17 / 17	0.97 (0.44)	24VDC	P2LCZ593EENDBB49	P2LCZ513EENDBB49
				120VAC	P2LCZ593EENDBB53	P2LCZ513EENDBB53

P2LAZ Shown

5/3 - 3-Position, All Ports Blocked, Non-locking Manual Override

Port Size	Cv	Response Time (msec)	Weight lb (kg)	Voltage	Part Number	
					(NPT)	(BSPP)
1/8	0.6	18 / 40	0.57 (0.26)	24VDC	P2LAZ691EENDBB49	P2LAZ611EENDBB49
				120VAC	P2LAZ691EENDBB53	P2LAZ611EENDBB53
1/4	1.5	22 / 55	0.62 (0.28)	24VDC	P2LBZ692EENDBB49	P2LBZ612EENDBB49
				120VAC	P2LBZ692EENDBB53	P2LBZ612EENDBB53
3/8	2.5	30 / 90	1.32 (0.60)	24VDC	P2LCZ693EENDBB49	P2LCZ613EENDBB49
				120VAC	P2LCZ693EENDBB53	P2LCZ613EENDBB53

P2LAZ Shown

Most popular. Notes: Response time: Actuate to 90% pressure / return to exhaust to 10% of supply pressure. 93 PSIG (6.3 bar) / temperature 68°F (20°C)



For inventory, lead times, and kit lookup, visit www.pdnplu.com

5/3 - 3-Position, Pressure Center, Non-locking Manual Override

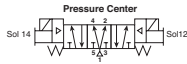

P2LAZ Shown

Port Size	Cv	Response Time (msec)	Weight lb (kg)	Voltage	Part Number (NPT)	Part Number (BSPP)
1/8	0.6	18 / 40	0.57 (0.26)	24VDC	P2LAZ791EENDBB49	P2LAZ711EENDBB49
				120VAC	P2LAZ791EENDBB53	P2LAZ711EENDBB53
1/4	1.5	22 / 55	0.62 (0.28)	24VDC	P2LBZ792EENDBB49	P2LBZ712EENDBB49
				120VAC	P2LBZ792EENDBB53	P2LBZ712EENDBB53
3/8	2.5	30 / 90	1.32 (0.60)	24VDC	P2LCZ793EENDBB49	P2LCZ713EENDBB49
				120VAC	P2LCZ793EENDCB53	P2LCZ713EENDBB53

5/3 - 3-Position, Center Exhaust

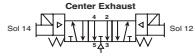

P2LAZ Shown

Port Size	Cv	Response time (msec)	Weight lb (kg)	Voltage	Part Number (NPT)	Part Number (BSPP)
1/8	0.6	18 / 40	0.57 (0.26)	24VDC	P2LAZ891EENDBB49	P2LAZ811EENDBB49
				120VAC	P2LAZ891EENDBB53	P2LAZ811EENDBB53
1/4	1.5	22 / 55	0.62 (0.28)	24VDC	P2LBZ892EENDBB49	P2LBZ812EENDBB49
				120VAC	P2LBZ892EENDBB53	P2LBZ812EENDBB53
3/8	2.5	30 / 90	1.32 (0.60)	24VDC	P2LCZ893EENDBB49	P2LCZ813EENDBB49
				120VAC	P2LCZ893EENDBB53	P2LCZ813EENDBB53

Notes: Response time: Actuate to 90% pressure / return to exhaust to 10% of supply pressure. 93 PSIG (6.3 bar) / temperature 68°F (20°C)

Viking Lite Single & Double Solenoid Operated Valves

P2L A Z 5 91 ES N D C B 49

Valve Size

1/8"	A
1/4"	B
3/8"	C

Series

Viking Lite	Z
-------------	---

Valve Type / Function

<i>Internal pilot supply to solenoid</i>	
3/2 NC - 2-Position	3
5/2 2-Position	5
5/3 3-Position, APB	6
5/3 3-Position, PC	7
5/3 3-Position, CE	8

Main port thread

G1/8 (P2LA)	11
G1/4 (P2LB)	12
G3/8 (P2LC)	13
1/8" NPT (P2LA)	91
1/4" NPT (P2LB)	92
3/8" NPT (P2LC)	93

Voltage / Frequency

49	24VDC
53	120VAC
Blank	Valve Less Coil

Enclosures / Lead Length

B	22mm Rectangular 3-Pin - Type B Industrial (Male Only)
N	Valve Less Coil

Overrides

C	Extended - Locking
B	Flush - Non-Locking

Solenoid Pilot Type

D	Pilot Exhaust Vented
---	----------------------

Valve Type

N	14°F to 122°F (-10°C to 50°C)
---	-------------------------------

12 End Operator

EE	Double Solenoid
ES*	Single Solenoid, Spring Return

* Not available with 3-position valves.

 Most popular.



For inventory, lead times, and kit lookup, visit www.pdnplu.com

Part Numbers / Ordering Information

Single Remote Air Pilot, 3-way, 2-position

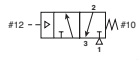

P2LBZ Shown

Port Size (NPT)	Cv	Response Time (msec)	Weight lb (kg)	Valve Type	Part Number
1/8"	0.7	15 / 45	0.25 (0.11)	P2LAX	P2LAZ391PS
1/4"	1.3	25 / 65	0.25 (0.11)	P2LBX	P2LBZ392PS
3/8"	2.5	25 / 65	0.67 (0.30)	P2LCX	P2LCZ393PS

Single Remote Air Pilot, 4-way, 2-position

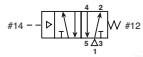

P2LBZ Shown

Port Size (NPT)	Cv	Response Time (msec)	Weight lb (kg)	Valve Type	Part Number
1/8"	0.7	15 / 45	0.27 (0.12)	P2LAX	P2LAZ591PS
1/4"	1.3	20 / 55	0.27 (0.12)	P2LBX	P2LBZ592PS
3/8"	2.5	25 / 85	0.85 (0.35)	P2LCX	P2LCZ593PS

Double Remote Air Pilot, 4-way, 2-position



P2LBZ Shown

Port Size (NPT)	Cv	Response Time (msec)	Weight lb (kg)	Valve Type	Part Number
1/8"	0.7	11 / 11	0.22 (0.10)	P2LAX	P2LAZ591PP
1/4"	1.3	13 / 13	0.26 (0.12)	P2LBX	P2LBZ592PP
3/8"	2.5	18 / 18	0.77 (0.35)	P2LCX	P2LCZ593PP

Notes: Response time: Actuate to 90% pressure / return to exhaust to 10% of supply pressure. 93 PSIG (6.3 bar) / temperature 68°F (20°C).

Viking Lite Remote Air Pilot Operated Valves

P2LAZ591PS

Valve Size	
1/8"	A
1/4"	B
3/8"	C

Operators / Return	
PP	Double Remote Pilot, 5/32" (4mm) tube
PS*	Single Remote Pilot, Spring Return, 5/32" (4mm) Tube

* Not available with 3-position valves.

Valve Type / Function	
<i>Internal Pilot Supply To Solenoid</i>	
3/2 NC - 2-Position	3
5/2 2-Position	5
5/3 3-Position, APB	6
5/3 3-Position, PC	7
5/3 3-Position, CE	8

Main Port Thread	
11	G1/8 (P2LA)
12	G1/4 (P2LB)
13	G3/8 (P2LC)
91	1/8" NPT (P2LA)
92	1/4" NPT (P2LB)
93	3/8" NPT (P2LC)

 Most popular.



For inventory, lead times, and kit lookup, visit www.pdnplu.com

IEM Bar Manifold, Inline Valve Only*



Valve Series	Valve Function	# of Stations	Weight lb (kg)	Manifold Only (NPT)	Manifold Only (BSPP)
P2LAZ / P2LBZ	3-way	2	0.84 (0.38)	91213202SXZN	91213202SXZ
P2LAZ / P2LBZ	3-way	4	1.41 (0.64)	91213204SXZN	91213204SXZ
P2LAZ / P2LBZ	3-way	6	1.96 (0.89)	91213206SXZN	91213206SXZ
P2LAZ / P2LBZ	3-way	8	2.54 (1.15)	91213208SXZN	91213208SXZ
P2LAZ / P2LBZ	3-way	10	3.09 (1.40)	91213210SXZN	91213210SXZ

Kits include: Manifold, valve hold down bolts, gaskets.



Valve Series	Valve Function	# of Stations	Weight lb (kg)	Manifold Only (NPT)	Manifold Only (BSPP)
P2LAZ	4-way	2	0.68 (0.31)	9121658068N	9121658068
P2LAZ	4-way	4	1.06 (0.48)	9121658075N	9121658075
P2LAZ	4-way	6	1.39 (0.63)	9121658076N	9121658076
P2LAZ	4-way	8	1.76 (0.80)	9121658077N	9121658077
P2LAZ	4-way	10	2.16 (0.98)	9121658078N	9121658078

Kits include: Manifold, valve hold down bolts, gaskets.



Valve Series	Valve Function	# of Stations	Weight lb (kg)	Manifold Only (NPT)	Manifold Only (BSPP)
P2LBZ	4-way	2	1.53 (0.69)	9121594805XN	9121594805X
P2LBZ	4-way	4	2.49 (1.13)	9121594806XN	9121594806X
P2LBZ	4-way	6	3.44 (1.56)	9121594807XN	9121594807X
P2LBZ	4-way	8	4.41 (2.00)	9121594808XN	9121594808X
P2LBZ	4-way	10	5.40 (2.45)	9121594812XN	9121594812X

Kits include: Manifold, valve hold down bolts, gaskets.

* For odd number of stations, consider Viking Xtreme bar manifold.

IEM Bar Manifold, Inline Valve Only



Valve Series	Valve Function	# of Stations	Manifold Only (NPT & BSPP)
P2LCZ	4-way		Use Viking Xtreme IEM bar manifold

Note: Only 4-way Viking Lite will mount on Viking Xtreme manifold. If 3-way desired, use 4-way and plug part #2 for N.C. valve function.

Manifold Accessories / Parts



Valve Series	Description	Weight lb (kg)	Kit Number
P2LAZ / P2LBZ *	3-way: Blanking kit with mounting screws (2)	0.22 (0.10)	912132BPSXZ
P2LAZ *	4-way: Blanking kit with mounting screws (2)	0.11 (0.05)	9121658063
P2LBZ *	4-way: Blanking kit with mounting screws (2)	0.04 (0.02)	9121594809X

*Note: O-ring for blanking kit included with manifold. For replacement o-rings or fastener bolts, use Viking Xtreme Kits.

22mm Rectangular 3-Pin – Type B Industrial (Use with Enclosure “B”)

Description	Connector with 6' (2m) Cord	Connector
Unlighted	PS2429JBP	PS2429BP
Light – 24VDC	PS2430J79BP*	PS243079BP
Light – 120V/60Hz	PS2430J83BP*	PS243083BP

* LED with surge suppression.

Note: Max ø6.5mm cable size required for connector w/o 6' (2m) cord. IP65 rated when properly installed.

Engineering data:

conductors: 2 poles plus ground; cable range (connector only): 6 to 8mm (0.24 To 0.31 Inch); contact spacing: 11mm

Most popular.

Replacement Parts

Description	Part Number
24VDC solenoid coil kit	P2FCB449
110VAC solenoid coil kit	P2FCB453
Remote pilot kit	P2FP1P
*Includes adaptor, gasket, screws	
Solenoid nut, diffuser	PS1556
Solenoid nut, vented	PS2892P



For inventory, lead times, and kit lookup, visit www.pdnplu.com

P2LAZ 3/2 Single & Double Operators – Solenoid & Remote Air Pilot

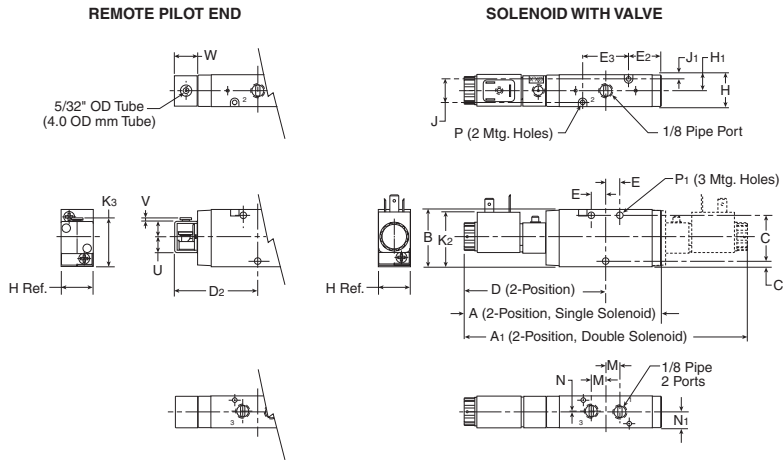

**P2LAZ 3/2
 Solenoid & Remote Air Pilot**

A	A1	B	C	C1	D
5.35 (136)	7.68 (195)	1.57 (40)	1.26 (32)	.16 (4)	3.84 (97.5)
D2	E	E2	E3	H	H1
2.28 (58)	.39 (10)	.91 (23)	1.26 (32)	.87 (22)	.43 (11)
J	J1	K2	K3	M	N
.65 (16.5)	.11 (2.75)	1.50 (38)	1.31 (33.2)	.39 (10)	.02 (.5)
N1	P	P1	U	V	W
.43 (11)	Ø .12 (3.1)	Ø .17 (4.3)	0.43 (11)	0.087 (2.2)	0.59 (15.2)

Inches (mm)

P2LAZ 3/2 Single & Double Operators – IEM Aluminum Bar Manifold

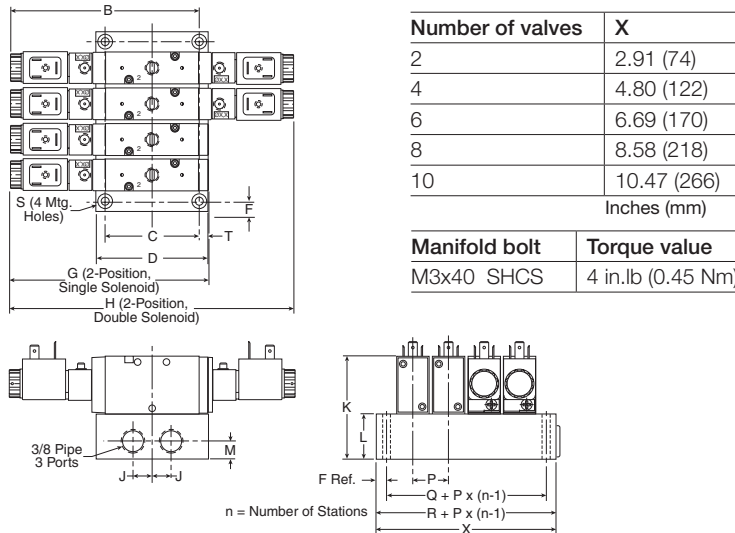

**P2LAZ 3/2
 IEM Aluminum Bar Manifold**

B	C	D	F	G
5.06 (128.5)	2.44 (62)	2.99 (76)	.28 (7)	5.35 (136)
H	J	K	L	M
7.68 (195)	.51 (13)	2.78 (70.5)	1.20 (30.5)	.47 (12)
P	Q	R	S	T
.94 (24)	1.42 (36)	1.97 (50)	Ø .22 (5.5)	.88 (7)

Inches (mm)

P2LAZ 5/2 & 5/3 Single & Double Operators – Solenoid & Remote Air Pilot

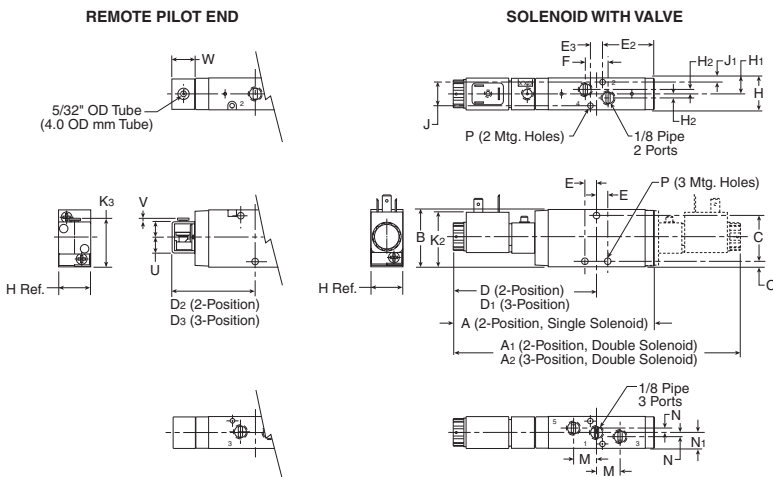

**P2LAZ 5/2 & 5/3
 Solenoid & Remote Air Pilot**

A	A1	A2	B	C	C1
5.47 (139)	7.76 (197)	8.70 (221)	1.57 (40)	1.30 (33)	.14 (3.5)
D	D1	D2	D3	E	E2
3.88 (98.5)	4.35 (110.5)	2.33 (59.3)	2.80 (71)	.31 (8)	1.86 (47.3)
E3	F	H	H1	H2	J
.33 (8.5)	.63 (16)	.87 (22)	.43 (11)	.12 (3)	.63 (16)
J1	K2	K3	M	N	N1
.12 (3)	1.50 (38)	1.31 (33.2)	.63 (16)	.12 (3)	.43 (11)
P	U	V	W		
Ø .16 (4.1)	0.43 (11)	0.087 (2.2)	0.59 (15.2)		

Inches (mm)



For inventory, lead times, and kit lookup, visit www.pdnplu.com

P2LAZ 5/2 & 5/3 Single & Double Operators – IEM Aluminum Bar Manifold

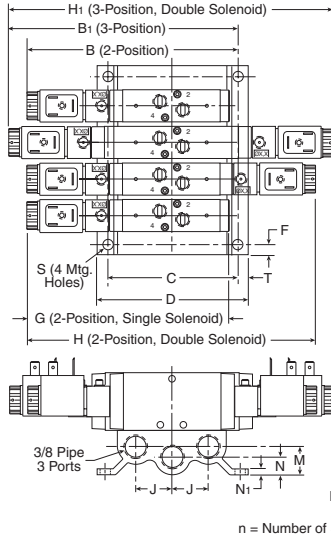

Number of valves	X
2	3.07 (78)
4	4.96 (126)
6	6.85 (174)
8	8.74 (222)
10	10.63 (270)
Inches (mm)	
Manifold bolt	Torque value
M4x45 Screw MRX	9 in.lb (0.75 Nm)

**P2LAZ 5/2 & 5/3
 IEM Aluminum Bar Manifold**

B	B ₁	C	D	F
5.10 (149.5)	6.36 (161.5)	3.46 (88)	4.02 (102)	.28 (7)
G	H	H ₁	J	K
5.47 (139)	7.76 (197)	8.70 (221)	.96 (24.5)	2.76 (70)
L	M	N	N ₁	P
1.18 (30)	.75 (19)	.47 (12)	.16 (4)	.94 (24)
Q	R	S	T	
1.57 (40)	2.13 (54)	∅.28 (7)	.28 (7)	
Inches (mm)				

n = Number of Stations

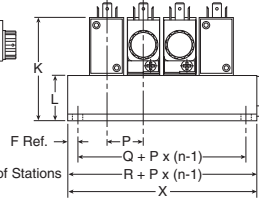

P2LBZ 3/2 Single & Double Operators – Solenoid & Remote Air Pilot

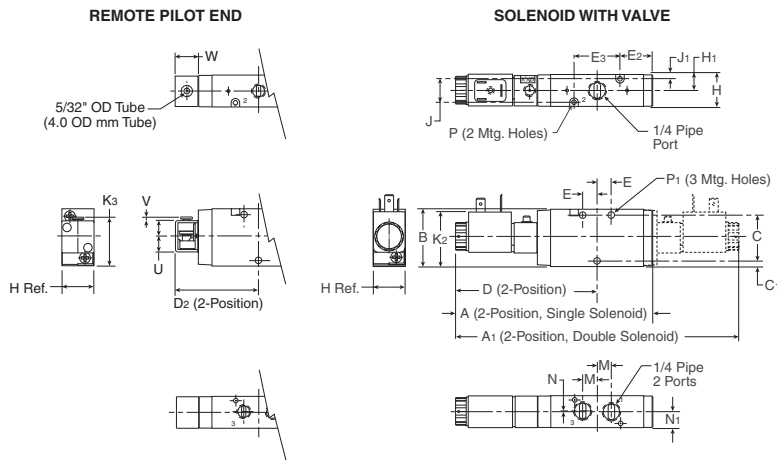

**P2LBZ 3/2
 Solenoid & Remote Air Pilot**

A	A ₁	B	C	C ₁	D
5.35 (136)	7.68 (195)	1.57 (40)	1.26 (32)	.16 (4)	3.84 (97.5)
D ₂	E	E ₁	E ₃	H	H ₁
2.28 (58)	.39 (10)	.91 (23)	1.26 (32)	.87 (22)	.43 (11)
J	J ₁	K ₂	K ₃	M	N
.65 (16.5)	.11 (2.75)	1.50 (38)	1.31 (33.2)	.39 (10)	.02 (.5)
N ₁	P	P ₁	U	V	W
.43 (11)	∅.12 (3.1)	∅.17 (4.3)	0.43 (11)	0.087 (2.2)	0.59 (15.2)
Inches (mm)					

P2LBZ 3/2 Single & Double Operators – IEM Aluminum Bar Manifold

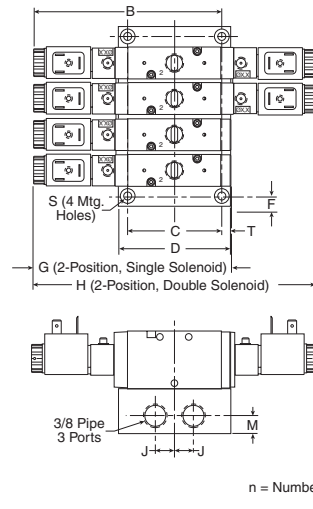

Number of valves	X
2	2.91 (74)
4	4.80 (122)
6	6.69 (170)
8	8.58 (218)
10	10.47 (266)
Inches (mm)	
Manifold bolt	Torque value
M3x40 SCHS	4 in.lb (0.45 Nm)

**P2LBZ 3/2
 IEM Aluminum Bar Manifold**

B	C	D	F	G
5.06 (128.5)	2.44 (62)	2.99 (76)	.28 (7)	5.35 (136)
H	J	K	L	M
7.68 (195)	.51 (13)	2.78 (70.5)	1.20 (30.5)	.47 (12)
P	Q	R	S	T
.94 (24)	1.42 (36)	1.97 (50)	∅.22 (5.5)	.88 (7)
Inches (mm)				

n = Number of Stations

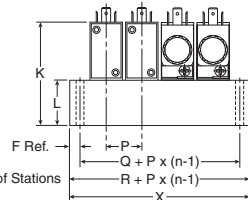

For inventory, lead times, and kit lookup, visit www.pdnplu.com

P2LBZ 5/2 & 5/3 Single & Double Operators – Solenoid & Remote Air Pilot

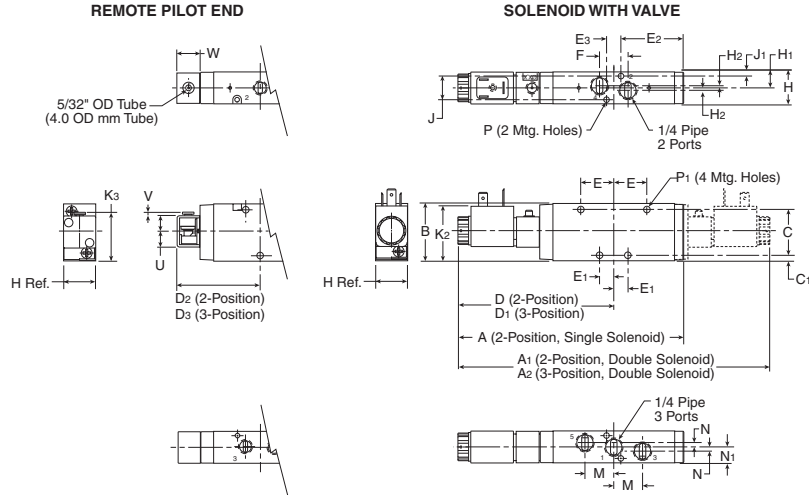

P2LBZ 5/2 & 5/3 Solenoid & Remote Air Pilot

A	A1	A2	B	C	C1
6.14 (156)	8.46 (215)	9.29 (236)	1.57 (40)	1.26 (32)	.16 (4)
D	D1	D2	D3	E	E1
4.23 (107.5)	4.65 (118)	2.68 (68)	3.09 (78.5)	.91 (23)	.39 (10)
E2	E3	F	H	H1	H2
1.14 (29)	.39 (10)	.79 (20)	.87 (22)	.43 (11)	.06 (1.5)
J	J1	K2	K3	M	N
.65 (16.5)	.11 (2.8)	1.50 (38)	1.31 (33.2)	.79 (20)	.08 (2)
N1	P	P1	U	V	W
.43 (11)	Ø .12 Ø (3.1)	Ø .17 Ø (4.3)	0.43 (11)	0.087 (2.2)	0.59 (15.2)

Inches (mm)

P2LBZ 5/2 & 5/3 Single & Double Operators – IEM Aluminum Bar Manifold

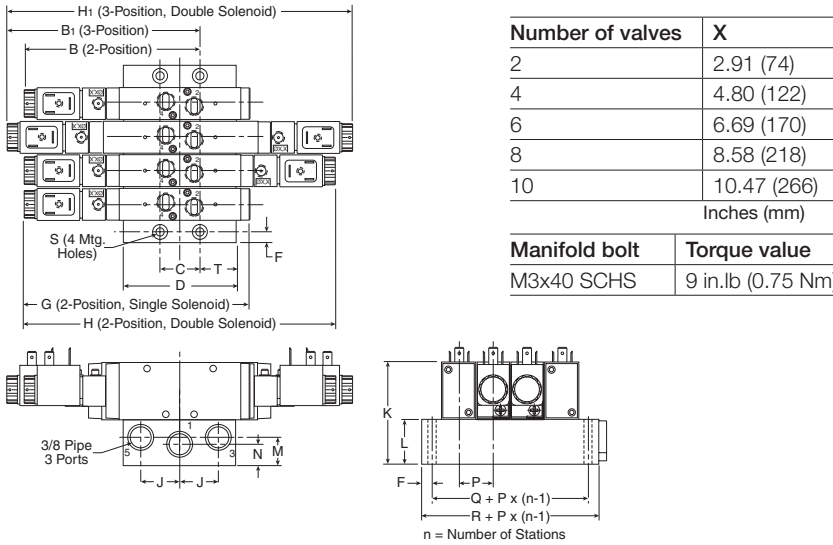

Number of valves	X
2	2.91 (74)
4	4.80 (122)
6	6.69 (170)
8	8.58 (218)
10	10.47 (266)
Inches (mm)	
Manifold bolt	Torque value
M3x40 SCHS	9 in.lb (0.75 Nm)

P2LBZ 5/2 & 5/3 IEM Aluminum Bar Manifold

B	B1	C	D	F
4.43 (112.5)	4.84 (123)	1.04 (26.5)	2.99 (76)	.28 (7)
G	H	H1	J	K
6.14 (156)	8.46 (215)	9.29 (236)	1.02 (26)	2.781 (70.5)
L	M	N	P	Q
1.20 (30.5)	.75 (19)	.57 (14.5)	.94 (24)	1.42 (36)
R	S	T		
1.97 (50)	Ø .22 Ø (5.5)	.97 (25)		

Inches (mm)

P2LCZ 3/2 Single & Double Operators – Solenoid & Remote Pilot

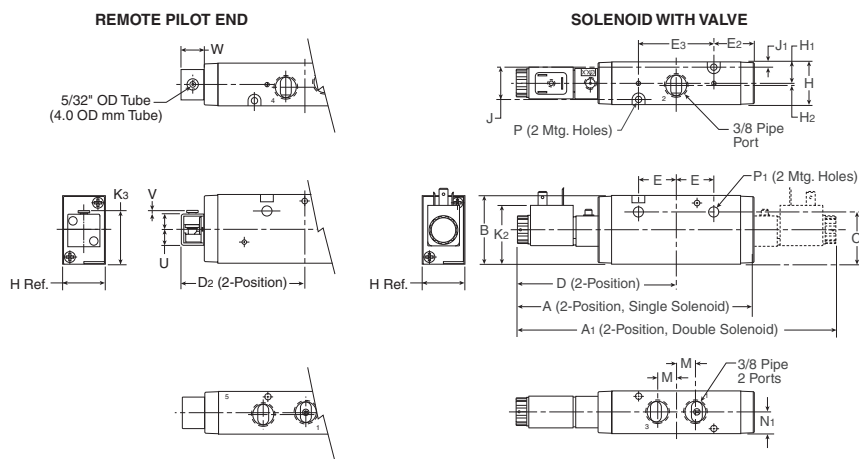

P2LCZ 3/2 Solenoid & remote Air Pilot

A	A1	B	C	D	D2
6.50 (165)	8.66 (220)	1.89 (48)	1.46 (37)	4.33 (110)	2.78 (70.5)
E	E2	E3	H	H1	H2
1.04 (26.5)	1.10 (28)	2.09 (53)	1.18 (30)	.59 (15)	.06 (1.55)
J	J1	K2	K3	M	N1
.91 (23)	.14 (3.5)	1.50 (38)	1.46 (37.2)	.53 (13.5)	.59 (15)
P	P1	U	V	W	
Ø .17 Ø (4.4)	Ø .27 Ø (6.9)	0.43 (11)	0.087 (2.2)	0.59 (15.2)	

Inches (mm)

C

Inline Valves
Viking Lite
Viking Extreme
B3, B5, B6 Series
B7, B8 Series
"N" Series



For inventory, lead times, and kit lookup, visit www.pdnplu.com

P2LCZ 5/2 & 5/3 Single & Double Operators – Solenoid & Remote Air Pilot

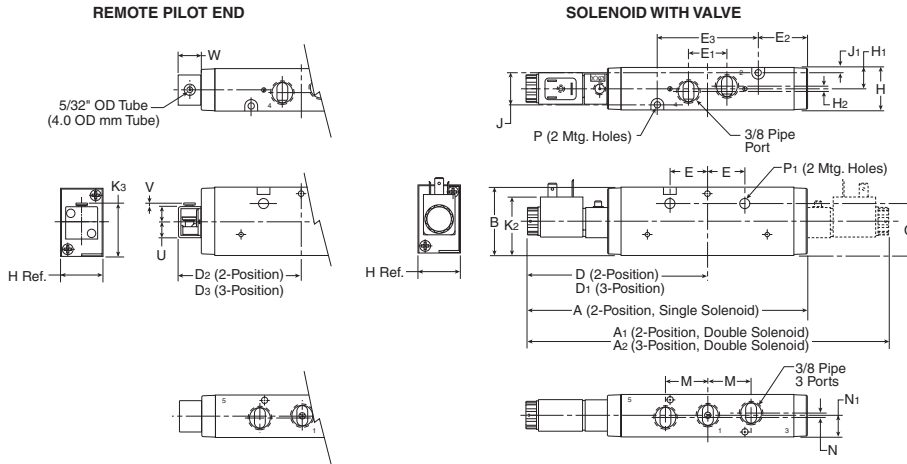

**P2LBZ 5/2 & 5/3
 Solenoid & Remote Air Pilot**

A	A1	A2	B	C
7.68 (195)	9.88 (251)	10.70 (272)	1.89 (48)	1.46 (37)
D	D1	D2	D3	E
4.94 (125.5)	5.35 (136)	3.39 (86)	3.80 (96.5)	1.04 (26.5)
E1	E2	E3	H	H1
1.06 (27)	1.71 (43.5)	2.80 (71)	1.18 (30)	.59 (15)
H2	J	J1	K2	K3
.12 (.3)	.91 (23)	.14 (3.5)	1.50 (38)	1.48 (37.5)
M	N	N1	P	P1
1.18 (30)	.08 (2)	.59 (15)	Ø .17 (Ø 4.4)	Ø .27 (Ø 6.9)
U	V	W		
0.43 (11)	0.087 (2.2)	0.59 (15.2)		

Inches (mm)

P2LCZ 5/2 & 5/3 Single & Double Operators – IEM Aluminum Bar Manifold

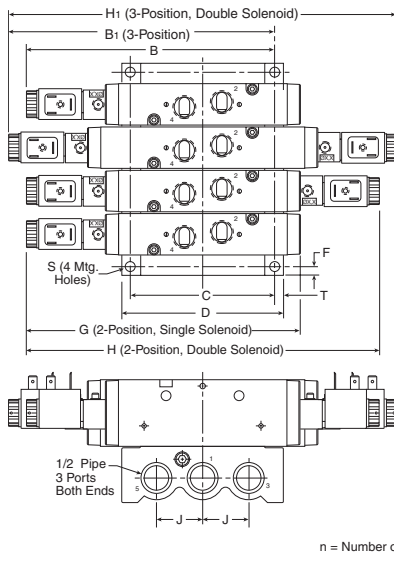

Number of valves	X
2	3.29 (84)
4	5.96 (152)
6	8.44 (215)
8	10.93 (278)
10	13.41 (341)

Manifold bolt	Torque value
M4x50 SCHS	15 in.lb (2.0 Nm)

**P2LCZ 5/2 & 5/3
 IEM Aluminum Bar Manifold**

C	D	F	G	H	
3.97 (101)	4.41 (112)	.24 (6)	7.68 (195)	9.88 (251)	
H1	J	K	L	P	
10.70 (272)	1.26 (32)	3.43 (87)	1.54 (39)	1.24 (31.5)	
Q	R	S	T		
1.77 (45)	2.24 (57)	Ø .26 (Ø 6.5)	.24 (6)		

Inches (mm)

C
 Inline Valves
 Viking Lite
 Viking Extreme
 B3, B5, B6 Series
 B7, B8 Series
 Air-Saver Unit
 "N" Series



For inventory, lead times, and kit lookup, visit www.pdnplu.com

Features

Viking Xtreme Series

The Viking Xtreme valve range is robust, versatile and combines high performance with compact installation dimensions. Large flow capacity, short change-over times and low change-over pressure are important characteristics of this valve range.

Ports

- P2LAX: 1/8 inch NPT & BSPP
- P2LBX: 1/4 inch NPT & BSPP
- P2LCX: 3/8 inch NPT & BSPP
- P2LDX: 1/2 inch NPT & BSPP

Mounting

- Inline
- IEM aluminum bar

Solenoids

- 1.2 watts to 7.3 watts
- 22mm (Type B) & 30mm 3-pin (DIN 43650)
- 15mm 3-pin (EN 17530-803)
- M12, 4-pin, surge suppression
- Grommet, surge suppression
- Conduit
- Deutsche Connectors, surge suppression

12VDC to 240VAC

Certification / approval

- IP65 Rated, RoHS, CE
- cCSAus Approved to 145 PSIG (10 bar)
- Canada Registration Number available (CRN)
- ATEX option available

Mobile applications

- Viking Xtreme tested to +5g shock and vibration
- Solenoids operate with wide voltage tolerance bands
- Corrosion resistant design
- Passed 500 hour salt spray test

Material specifications

Body	Anodized aluminum
End caps	Anodized aluminum
Coils	Thermoplastic
Fasteners	Stainless steel
Spool	Aluminum and nitrile rubber
Springs	Stainless steel

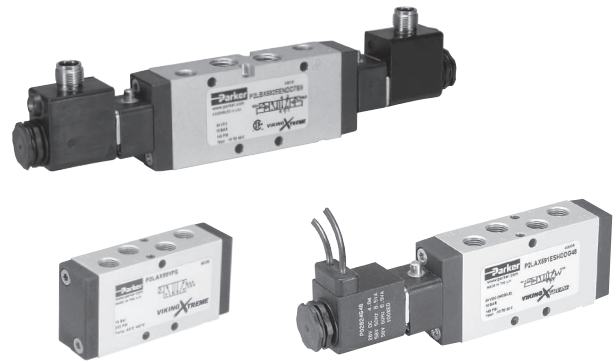

Operating information

Operating pressure:
 Normal: Vacuum to 145 PSIG (Vacuum to 10 bar)
 Xtreme: (P2LAX & P2LBX) Vacuum to 232 PSIG (Vacuum to 16 bar)
 (P2LCX & P2LDX) Vacuum to 174 PSIG (Vacuum to 12 bar)
 Minimum: See chart
 Operating temperature:
 Normal: 14°F to 122°F (-10°C to 50°C)
 Xtreme: -40°F to 158°F (-40°C to 70°C)

Minimum operating pressure, PSIG (bar)

Valve Type - Internal Pilot	P2LAX	P2LBX	P2LCX	P2LDX
Single solenoid - spring return	46 (3.2)	51 (3.5)	51 (3.5)	51 (3.5)
Single remote pilot - spring return	46 (3.2)	51 (3.5)	51 (3.5)	51 (3.5)
Double solenoid - 2-position	22 (1.5)	22 (1.5)	22 (1.5)	22 (1.5)
Double remote pilot - 2-position	22 (1.5)	22 (1.5)	22 (1.5)	22 (1.5)
Double solenoid - 3-position (APB, PC, CE)	51 (3.5)	51 (3.5)	51 (3.5)	51 (3.5)
Double remote pilot - 3-position (APB, PC, CE)	51 (3.5)	51 (3.5)	51 (3.5)	51 (3.5)

Features

Over Molded Spool



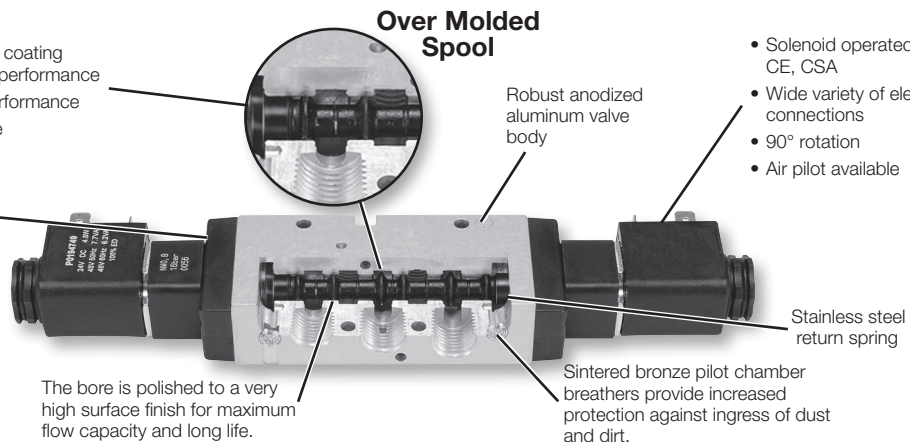

- Aluminum spool with nitrile rubber coating ground to exact size for optimum performance
- Precision ground for maximum performance
- Wide operating temperature range
 - Low temperature to -40°

Diecast end covers with stainless steel screws to resist aggressive environments.



For inventory, lead times, and kit lookup, visit www.pdnplu.com

Single Solenoid, 3-way, 2-position, Normal Operating Pressure / Temperature, Non-locking Manual Override

Solenoid	Port Size (NPT)	Cv	Valve Type	Response Time (msec)	Weight lb (kg)	Voltage	Part Number		
 <p>P2LAX 22mm DIN Shown</p>	1/8"	0.7	P2LAX	18 / 40	0.84 (0.38)	24VDC	P2LAX391ESNDDDB49		
						120VAC	P2LAX391ESNDDDB53		
		1/4"	1.3	P2LBX	18 / 45	0.84 (0.38)	24VDC	P2LBX392ESNDDDB49	
							120VAC	P2LBX392ESNDDDB53	
	3/8"	2.5	P2LCX	25 / 75	1.72 (0.78)	24VDC	P2LCX393ESNDDDB49		
						120VAC	P2LCX393ESNDDDB53		
	1/2"	2.7	P2LDX	25 / 75	1.72 (0.78)	24VDC	P2LDX394ESNDDDB49		
						120VAC	P2LDX394ESNDDDB53		
	 <p>P2LAX 18" Grommet Shown</p>	1/8"	0.7	P2LAX	18 / 40	0.84 (0.38)	24VDC	P2LAX391ESNDDDG49	
							120VAC	P2LAX391ESNDDDG53	
			1/4"	1.3	P2LBX	18 / 45	0.84 (0.38)	24VDC	P2LBX392ESNDDDG49
								120VAC	P2LBX392ESNDDDG53
3/8"		2.5	P2LCX	25 / 75	1.72 (0.78)	24VDC	P2LCX393ESNDDDG49		
						120VAC	P2LCX393ESNDDDG53		
1/2"		2.7	P2LDX	25 / 75	1.72 (0.78)	24VDC	P2LDX394ESNDDDG49		
						120VAC	P2LDX394ESNDDDG53		
 <p>P2LAX M12 Coil Shown</p>		1/8"	0.7	P2LAX	18 / 40	0.84 (0.38)	24VDC	P2LAX391ESNDD7B9	
							24VDC	P2LBX392ESNDD7B9	
			1/4"	1.3	P2LBX	18 / 45	0.84 (0.38)	24VDC	P2LBX392ESNDD7B9
								24VDC	P2LCX393ESNDD7B9
	3/8"	2.5	P2LCX	25 / 75	1.72 (0.78)	24VDC	P2LCX393ESNDD7B9		
						24VDC	P2LCX393ESNDD7B9		
	1/2"	2.7	P2LDX	25 / 75	1.72 (0.78)	24VDC	P2LDX394ESNDD7B9		
						24VDC	P2LDX394ESNDD7B9		
	 <p>P2LAX 15mm DIN Shown</p>	1/8"	0.7	P2LAX	18 / 40	0.84 (0.38)	24VDC	P2LAX391ESNXB549	
							120VAC	P2LAX391ESNXB553	
			1/4"	1.3	P2LBX	18 / 45	0.84 (0.38)	24VDC	P2LBX392ESNXB549
								120VAC	P2LBX392ESNXB553
3/8"		2.5	P2LCX	25 / 75	1.72 (0.78)	24VDC	P2LCX393ESNXB549		
						120VAC	P2LCX393ESNXB553		
1/2"		2.7	P2LDX	25 / 75	1.72 (0.78)	24VDC	P2LDX394ESNXB549		
						120VAC	P2LDX394ESNXB553		

Notes: Above valves are rated for an operating temperature from 14°F to 122°F (-10°C to 50°C). See model code matrix for additional options.
Response time: Actuate to 90% pressure / return to exhaust to 10% of supply pressure. 93 PSIG (6.3 bar) / temperature 68°F (20°C).

 Most popular.



For inventory, lead times, and kit lookup, visit www.pdnplu.com

C

Inline Valves

Viking Lite

Viking Extreme





B3, B5, B6 Series

B7, B8 Series

Air-Saver Unit

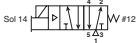
"N" Series

Single Solenoid, 4-way, 2-position, Normal Operating Pressure / Temperature, Non-locking Manual Override

	Solenoid	Port Size (NPT)	Cv	Valve Type	Response Time (msec)	Weight lb (kg)	Voltage	Part Number
	22mm DIN	1/8"	0.7	P2LAX	15 / 35	0.49 (0.22)	24VDC 120VAC	P2LAX591ESNDDDB49 P2LAX591ESNDDDB53
		1/4"	1.3	P2LBX	18 / 45	0.84 (0.38)	24VDC 120VAC	P2LBX592ESNDDDB49 P2LBX592ESNDDDB53
		3/8"	2.5	P2LCX	27 / 75	1.68 (0.76)	24VDC 120VAC	P2LCX593ESNDDDB49 P2LCX593ESNDDDB53
		1/2"	2.7	P2LDX	25 / 75	1.68 (0.76)	24VDC 120VAC	P2LDX594ESNDDDB49 P2LDX594ESNDDDB53
P2LBX 22mm DIN Shown								
	18" Grommet	1/8"	0.7	P2LAX	15 / 35	0.49 (0.22)	24VDC 120VAC	P2LAX591ESNDDG49 P2LAX591ESNDDG53
		1/4"	1.3	P2LBX	18 / 45	0.84 (0.38)	24VDC 120VAC	P2LBX592ESNDDG49 P2LBX592ESNDDG53
		3/8"	2.5	P2LCX	27 / 75	1.68 (0.76)	24VDC 120VAC	P2LCX593ESNDDG49 P2LCX593ESNDDG53
		1/2"	2.7	P2LDX	25 / 75	1.68 (0.76)	24VDC 120VAC	P2LDX594ESNDDG49 P2LDX594ESNDDG53
P2LAX 18" Grommet Shown								
	M12 Coil with LED	1/8"	0.7	P2LAX	15 / 35	0.49 (0.22)	24VDC	P2LAX591ESNDD7B9
		1/4"	1.3	P2LBX	18 / 45	0.84 (0.38)	24VDC	P2LBX592ESNDD7B9
		3/8"	2.5	P2LCX	27 / 75	1.68 (0.76)	24VDC	P2LCX593ESNDD7B9
		1/2"	2.7	P2LDX	25 / 75	1.68 (0.76)	24VDC	P2LDX594ESNDD7B9
P2LAX M12 Coil Shown								
	15mm DIN	1/8"	0.7	P2LAX	15 / 35	0.49 (0.22)	24VDC 120VAC	P2LAX591ESNXB549 P2LAX591ESNXB553
		1/4"	1.3	P2LBX	18 / 45	0.84 (0.38)	24VDC 120VAC	P2LBX592ESNXB549 P2LBX592ESNXB553
		3/8"	2.5	P2LCX	27 / 75	1.68 (0.76)	24VDC 120VAC	P2LCX593ESNXB549 P2LCX593ESNXB553
		1/2"	2.7	P2LDX	25 / 75	1.68 (0.76)	24VDC 120VAC	P2LDX594ESNXB549 P2LDX594ESNXB553
P2LAX 15mm DIN Shown								

Notes: Above valves are rated for an operating temperature from 14°F to 122°F (-10°C to 50°C). See model code matrix for additional options.
Response time: Actuate to 90% pressure / return to exhaust to 10% of supply pressure. 93 PSIG (6.3 bar) / temperature 68°F (20°C).





C	Inline Valves
	Viking Lite
	Viking Extreme
	B3, B5, B6 Series
B7, B8 Series	
Air Saver Unit	
"N" Series	

 Most popular.

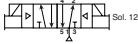

For inventory, lead times, and kit lookup, visit www.pdnplu.com

Double Solenoid, 4-way, 2-position, Normal Operating Pressure / Temperature, Non-locking Manual Override

Solenoid	Port Size (NPT)	Cv	Valve Type	Response Time (msec)	Weight lb (kg)	Voltage	Part Number	
  <p>22mm DIN</p> <p>P2LBX 22mm DIN Shown</p>	1/8"	0.7	P2LAX	10 / 10	0.60 (0.27)	24VDC 120VAC	P2LAX591EENDDDB49 P2LAX591EENDDDB53	
	1/4"	1.3	P2LBX	12 / 12	0.93 (0.42)	24VDC 120VAC	P2LBX592EENDDDB49 P2LBX592EENDDDB53	
	3/8"	2.5	P2LCX	17 / 17	1.78 (0.81)	24VDC 120VAC	P2LCX593EENDDDB49 P2LCX593EENDDDB53	
	1/2"	2.7	P2LDX	17 / 17	1.78 (0.81)	24VDC 120VAC	P2LDX594EENDDDB49 P2LDX594EENDDDB53	
	 <p>18" Grommet</p> <p>P2LAX 18" Grommet Shown</p>	1/8"	0.7	P2LAX	10 / 10	0.60 (0.27)	24VDC 120VAC	P2LAX591EENDDG49 P2LAX591EENDDG53
		1/4"	1.3	P2LBX	12 / 12	0.93 (0.42)	24VDC 120VAC	P2LBX592EENDDG49 P2LBX592EENDDG53
		3/8"	2.5	P2LCX	17 / 17	1.78 (0.81)	24VDC 120VAC	P2LCX593EENDDG49 P2LCX593EENDDG53
		1/2"	2.7	P2LDX	17 / 17	1.78 (0.81)	24VDC 120VAC	P2LDX594EENDDG49 P2LDX594EENDDG53
		 <p>M12 Coil with LED</p> <p>P2LBX M12 Coil Shown</p>	1/8"	0.7	P2LAX	10 / 10	0.60 (0.27)	24VDC
	1/4"		1.3	P2LBX	12 / 12	0.93 (0.42)	24VDC	P2LBX592EENDD7B9
	3/8"		2.5	P2LCX	17 / 17	1.78 (0.81)	24VDC	P2LCX593EENDD7B9
	1/2"		2.7	P2LDX	17 / 17	1.78 (0.81)	24VDC	P2LDX594EENDD7B9
 <p>15mm DIN</p> <p>P2LAX 15mm DIN Shown</p>	1/8"	0.7	P2LAX	10 / 10	0.60 (0.27)	24VDC 120VAC	P2LAX591EENXB549 P2LAX591EENXB553	
	1/4"	1.3	P2LBX	12 / 12	0.93 (0.42)	24VDC 120VAC	P2LBX592EENXB549 P2LBX592EENXB553	
	3/8"	2.5	P2LCX	17 / 17	1.78 (0.81)	24VDC 120VAC	P2LCX593EENXB549 P2LCX593EENXB553	
	1/2"	2.7	P2LDX	17 / 17	1.78 (0.81)	24VDC 120VAC	P2LDX594EENXB549 P2LDX594EENXB553	

Notes: Above valves are rated for an operating temperature from 14°F to 122°F (-10°C to 50°C). See model code matrix for additional options.
Response time: Actuate to 90% pressure / return to exhaust to 10% of supply pressure. 93 PSIG (6.3 bar) / temperature 68°F (20°C).

C

Inline Valves

Viking Lite

Viking Extreme

B3, B5, B6 Series

B7, B8 Series

Air-Saver Unit





"N" Series

 Most popular.



For inventory, lead times, and kit lookup, visit www.pdnplu.com

**Double Solenoid, 4-way, 3-position All Ports Blocked, 3-position Center Exhaust,
Normal Operating Pressure / Temperature, Non-locking Manual Override**

								Part number		
Solenoid	Port Size (NPT)	Cv	Valve Type	Response Time (msec)	Weight lb (kg)	Voltage	Sol 14		Sol 12	
							All Ports Blocked	Center Exhaust	All Ports Blocked	Center Exhaust
 22mm DIN P2LBX 22mm DIN Shown	1/8"	0.5	P2LAX	18 / 40	0.62 (0.28)	24VDC 120VAC	P2LAX691EENDDDB49 P2LAX691EENDDDB53	P2LAX891EENDDDB49 P2LAX891EENDDDB53		
	1/4"	0.9	P2LBX	22 / 55	0.97 (0.44)	24VDC 120VAC	P2LBX692EENDDDB49 P2LBX692EENDDDB53	P2LBX892EENDDDB49 P2LBX892EENDDDB53		
	3/8"	1.8	P2LCX	30 / 90	2.45 (1.11)	24VDC 120VAC	P2LCX693EENDDDB49 P2LCX693EENDDDB53	P2LCX893EENDDDB49 P2LCX893EENDDDB53		
	1/2"	1.9	P2LDX	30 / 90	2.45 (1.11)	24VDC 120VAC	P2LDX694EENDDDB49 P2LDX694EENDDDB53	P2LDX894EENDDDB49 P2LDX894EENDDDB53		
 18" Grommet P2LBX 18" Grommet Shown	1/8"	0.5	P2LAX	18 / 40	0.62 (0.28)	24VDC 120VAC	P2LAX691EENDDDG49 P2LAX691EENDDDG53	P2LAX891EENDDDG49 P2LAX891EENDDDG53		
	1/4"	0.9	P2LBX	22 / 55	0.97 (0.44)	24VDC 120VAC	P2LBX692EENDDDG49 P2LBX692EENDDDG53	P2LBX892EENDDDG49 P2LBX892EENDDDG53		
	3/8"	1.8	P2LCX	30 / 90	2.45 (1.11)	24VDC 120VAC	P2LCX693EENDDDG49 P2LCX693EENDDDG53	P2LCX893EENDDDG49 P2LCX893EENDDDG53		
	1/2"	1.9	P2LDX	30 / 90	2.45 (1.11)	24VDC 120VAC	P2LDX694EENDDDG49 P2LDX694EENDDDG53	P2LDX894EENDDDG49 P2LDX894EENDDDG53		
 M12 Coil with LED P2LBX M12 Coil Shown	1/8"	0.5	P2LAX	18 / 40	0.62 (0.28)	24VDC 120VAC	P2LAX691EENDD7B9	P2LAX891EENDD7B9		
	1/4"	0.9	P2LBX	22 / 55	0.97 (0.44)	24VDC 120VAC	P2LBX692EENDD7B9	P2LBX892EENDD7B9		
	3/8"	1.8	P2LCX	30 / 90	2.45 (1.11)	24VDC 120VAC	P2LCX693EENDD7B9	P2LCX893EENDD7B9		
	1/2"	1.9	P2LDX	30 / 90	2.45 (1.11)	24VDC 120VAC	P2LDX694EENDD7B9	P2LDX894EENDD7B9		
 15mm DIN P2LBX 15mm DIN Shown	1/8"	0.5	P2LAX	18 / 40	0.62 (0.28)	24VDC 120VAC	P2LAX691EENXB549 P2LAX691EENXB553	P2LAX891EENXB549 P2LAX891EENXB553		
	1/4"	0.9	P2LBX	22 / 55	0.97 (0.44)	24VDC 120VAC	P2LBX692EENXB549 P2LBX692EENXB553	P2LBX892EENXB549 P2LBX892EENXB553		
	3/8"	1.8	P2LCX	30 / 90	2.45 (1.11)	24VDC 120VAC	P2LCX693EENXB549 P2LCX693EENXB553	P2LCX893EENXB549 P2LCX893EENXB553		
	1/2"	1.9	P2LDX	30 / 90	2.45 (1.11)	24VDC 120VAC	P2LDX694EENXB549 P2LDX694EENXB553	P2LDX894EENXB549 P2LDX894EENXB553		

Notes: Above valves are rated for an operating temperature from 14°F to 122°F (-10°C to 50°C). See model code matrix for additional options.
Response time: Actuate to 90% pressure / return to exhaust to 10% of supply pressure. 93 PSIG (6.3 bar) / temperature 68°F (20°C).

 Most popular.



For inventory, lead times, and kit lookup, visit www.pdnplu.com

C

Inline Valves

Viking Lite

Viking Extreme





B3, B5, B6 Series

B7, B8 Series

Air Saver Unit

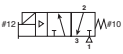



"N" Series

Single Solenoid, 3-way, 2-position, Xtreme Operating Pressure / Temperature, Non-locking Manual Override

Solenoid	Port Size (NPT)	Cv	Valve Type	Response Time (msec)	Weight lb (kg)	Voltage	Part Number
  P2LBX 22mm DIN Shown	1/8"	0.7	P2LAX	15 / 45	0.84 (0.38)	12VDC	P2LAX391ESHDDDB47
						24VDC	P2LAX391ESHDDDB48
	1/4"	1.3	P2LBX	25 / 65	0.84 (0.38)	12VDC	P2LBX392ESHDDDB47
						24VDC	P2LBX392ESHDDDB48
	3/8"	2.5	P2LCX	25 / 85	1.01 (0.46)	12VDC	P2LCX393ESHDDDB47
						24VDC	P2LCX393ESHDDDB48
	1/2"	2.7	P2LDX	25 / 85	1.01 (0.46)	12VDC	P2LDX394ESHDDDB47
						24VDC	P2LDX394ESHDDDB48
  P2LBX 18" Grommet Shown	1/8"	0.7	P2LAX	15 / 45	0.84 (0.38)	12VDC	P2LAX391ESHDDG47
						24VDC	P2LAX391ESHDDG48
	1/4"	1.3	P2LBX	25 / 65	0.84 (0.38)	12VDC	P2LBX392ESHDDG47
						24VDC	P2LBX392ESHDDG48
	3/8"	2.5	P2LCX	25 / 85	1.01 (0.46)	12VDC	P2LCX393ESHDDG47
						24VDC	P2LCX393ESHDDG48
	1/2"	2.7	P2LDX	25 / 85	1.01 (0.46)	12VDC	P2LDX394ESHDDG47
						24VDC	P2LDX394ESHDDG48

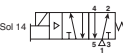
Notes: Above valves have Mobile Rated Coils and are rated for an operating temperature from -40°F to 158°F (-40°C to 70°C). See model code matrix for additional options.
Response time: Actuate to 90% pressure / return to exhaust to 10% of supply pressure. 93 PSIG (6.3 bar) / temperature 68°F (20°C).

Single Solenoid, 4-way, 2-position, Xtreme Operating Pressure / Temperature Non-locking Manual Override

Solenoid	Port Size (NPT)	Cv	Valve Type	Response Time (msec)	Weight lb (kg)	Voltage	Part Number
  P2LBX 22mm DIN Shown	1/8"	0.7	P2LAX	15 / 45	0.84 (0.38)	12VDC	P2LAX591ESHDDDB47
						24VDC	P2LAX591ESHDDDB48
	1/4"	1.3	P2LBX	20 / 55	0.84 (0.38)	12VDC	P2LBX592ESHDDDB47
						24VDC	P2LBX592ESHDDDB48
	3/8"	2.5	P2LCX	25 / 85	1.01 (0.46)	12VDC	P2LCX593ESHDDDB47
						24VDC	P2LCX593ESHDDDB48
	1/2"	2.7	P2LDX	25 / 85	1.01 (0.46)	12VDC	P2LDX594ESHDDDB47
						24VDC	P2LDX594ESHDDDB48
  P2LAX 18" Grommet Shown	1/8"	0.7	P2LAX	15 / 45	0.84 (0.38)	12VDC	P2LAX591ESHDDG47
						24VDC	P2LAX591ESHDDG48
	1/4"	1.3	P2LBX	25 / 65	0.84 (0.38)	12VDC	P2LBX592ESHDDG47
						24VDC	P2LBX592ESHDDG48
	3/8"	2.5	P2LCX	28 / 85	1.01 (0.46)	12VDC	P2LCX593ESHDDG47
						24VDC	P2LCX593ESHDDG48
	1/2"	2.7	P2LDX	25 / 85	1.01 (0.46)	12VDC	P2LDX594ESHDDG47
						24VDC	P2LDX594ESHDDG48



Notes: Above valves have Mobile Rated Coils and are rated for an operating temperature from -40°F to 158°F (-40°C to 70°C). See model code matrix for additional options.
Response time: Actuate to 90% pressure / return to exhaust to 10% of supply pressure. 93 PSIG (6.3 bar) / temperature 68°F (20°C).

 Most popular.



For inventory, lead times, and kit lookup, visit www.pdnplu.com

Double Solenoid, 4-way, 2-position, Xtreme Operating Pressure / Temperature, Non-locking Manual Override



Solenoid	Port Size (NPT)	Cv	Valve Type	Response Time (msec)	Weight lb (kg)	Voltage	Part Number
 <p>22mm DIN</p>	1/8"	0.7	P2LAX	11 / 11	0.60 (0.27)	12VDC	P2LAX591EEHDDDB47
						24VDC	P2LAX591EEHDDDB48
	1/4"	1.3	P2LBX	13 / 13	0.93 (0.42)	12VDC	P2LBX592EEHDDDB47
						24VDC	P2LBX592EEHDDDB48
	3/8"	2.5	P2LCX	18 / 18	1.06 (0.48)	12VDC	P2LCX593EEHDDDB47
						24VDC	P2LCX593EEHDDDB48
1/2"	2.7	P2LDX	18 / 18	1.06 (0.48)	12VDC	P2LDX594EEHDDDB47	
					24VDC	P2LDX594EEHDDDB48	
 <p>18" Grommet</p>	1/8"	0.7	P2LAX	11 / 11	0.60 (0.27)	12VDC	P2LAX591EEHDDG47
						24VDC	P2LAX591EEHDDG48
	1/4"	1.3	P2LBX	13 / 13	0.93 (0.42)	12VDC	P2LBX592EEHDDG47
						24VDC	P2LBX592EEHDDG48
	3/8"	2.5	P2LCX	18 / 18	1.06 (0.48)	12VDC	P2LCX593EEHDDG47
						24VDC	P2LCX593EEHDDG48
1/2"	2.7	P2LDX	18 / 18	1.06 (0.48)	12VDC	P2LDX594EEHDDG47	
					24VDC	P2LDX594EEHDDG48	

P2LBX 22mm DIN Shown

P2LAX 18" Grommet Shown

Notes: Above valves have Mobile Rated Coils and are rated for an operating temperature from -40°F to 158°F (-40°C to 70°C). See model code matrix for additional options. Response time: Actuate to 90% pressure / return to exhaust to 10% of supply pressure. 93 PSIG (6.3 bar) / temperature 68°F (20°C).

Double Solenoid, 4-way, 3-position All Ports Blocked, 3-position Center Exhaust, Xtreme Operating Pressure / Temperature Non-locking Manual Override

Solenoid	Port Size	Cv	Valve Type (NPT)	Response Time (msec)	Weight lb (kg)	Voltage	Part number	
							All Ports Blocked	Center Exhaust
 <p>22mm DIN</p>	1/8"	0.5	P2LAX	18 / 40	0.62 (0.28)	12VDC	P2LAX691EEHDDDB47	P2LAX891EEHDDDB47
							24VDC	P2LAX691EEHDDDB48
	1/4"	0.9	P2LBX	22 / 55	0.97 (0.44)	12VDC	P2LBX692EEHDDDB47	P2LBX892EEHDDDB47
							24VDC	P2LBX692EEHDDDB48
	3/8"	1.8	P2LCX	30 / 90	2.45 (1.11)	12VDC	P2LCX693EEHDDDB47	P2LCX893EEHDDDB47
							24VDC	P2LCX693EEHDDDB48
1/2"	1.9	P2LDX	30 / 90	2.45 (1.11)	12VDC	P2LDX694EEHDDDB47	P2LDX894EEHDDDB47	
						24VDC	P2LDX694EEHDDDB48	P2LDX894EEHDDDB48
 <p>18" Grommet</p>	1/8"	0.5	P2LAX	18 / 40	0.62 (0.28)	12VDC	P2LAX691EEHDDG47	P2LAX891EEHDDG47
							24VDC	P2LAX691EEHDDG48
	1/4"	0.9	P2LBX	22 / 55	0.97 (0.44)	12VDC	P2LBX692EEHDDG47	P2LBX892EEHDDG47
							24VDC	P2LBX692EEHDDG48
	3/8"	1.8	P2LCX	30 / 90	2.45 (1.11)	12VDC	P2LCX693EEHDDG47	P2LCX893EEHDDG47
							24VDC	P2LCX693EEHDDG48
1/2"	1.9	P2LDX	30 / 90	2.45 (1.11)	12VDC	P2LDX694EEHDDG47	P2LDX894EEHDDG47	
						24VDC	P2LDX694EEHDDG48	P2LDX894EEHDDG48

P2LBX 22mm DIN Shown

P2LBX 18" Grommet Shown

Notes: Above valves have Mobile Rated Coils and are rated for an operating temperature from -40°F to 158°F (-40°C to 70°C). See model code matrix for additional options. Response time: Actuate to 90% pressure / return to exhaust to 10% of supply pressure. 93 PSIG (6.3 bar) / temperature 68°F (20°C).

 Most popular.



For inventory, lead times, and kit lookup, visit www.pdnplu.com

Viking Xtreme Single & Double Solenoid Operated Valves

P2L A X 5 91 ES H D D G 49

Valve Size	
1/8"	A
1/4"	B
3/8"	C
1/2"	D

Series	
Viking Xtreme	X

Voltage	
B9 ‡	24 VDC w/ Surge Suppression & LED
42	24VAC
45	12VDC
46 †	12VDC Mobile with Surge Suppression
47*	12 VDC Mobile
48*	24 VDC Mobile
49	24VDC
53	120VAC
57	240VAC
Blank	Valve Less Coil

* Only available with enclosures "A", "B", "G" & "5".
 ‡ Enclosure "7" only
 † Enclosure "G", "T", "V" only.

Valve Type / Function	
Internal Pilot Supply to Solenoid*	
3/2 NC - 2-Position	3
5/2 2-Position	5
5/3 3-Position, APB	6
5/3 3-Position, PC	7
5/3 3-Position, CE	8
External Pilot Supply to the Solenoids Through Ports #12 & #14	
3/2 NC - 2-Position	L
5/2 2-Position	N
5/3 3-Position, APB	P
5/3 3-Position, PC	Q
5/3 3-Position, CE	R

* Size A & B solenoid valves can be field converted from internal to external pilot. See page C25 for details.

Main Port Thread	
G1/8 (P2LA)	11
G1/4 (P2LB)	12
G1/4 (P2LB) NAMUR Mount	1N*
G3/8 (P2LC)	13
G1/2 (P2LD)	14
1/8" NPT (P2LA)	91
1/4" NPT (P2LB)	92
1/4" NPT (P2LB) NAMUR Mount	9N*
3/8" NPT (P2LC)	93
1/2" NPT (P2LD)	94

* NAMUR mount available for 5/2, 2-position only.

Operator Return	
Double Solenoid	EE
Single Solenoid, Spring Return	ES*

* Not available with 3-position valves.

Enclosures / Lead Length	
5 †	15mm, 3-Pin DIN 43650C, 8mm Pin Spacing
7 §	M12 4-Pin Coil with Surge Suppression & LED
A	30mm Square 3-Pin – ISO 4400 Form A (male only)
B	22mm Rectangular 3-Pin – Type B Industrial (male only)
E*	Intrinsically Safe, FM / CSA
F †	Hazardous Duty 1/2" NPT, FM / CSA
G	Grommet - 18" Leads
H	1/2" NPT Conduit - 18" Leads
N**	Valve Less "A - V, 7" Enclosure
T #	Grommet, Single Solenoid, 2-Pin Deutsche Connector, Surge Suppression
V #	Grommet, Double Solenoid, 4-Pin Deutsche Connector, Surge Suppression
X †	Valve Less 15mm Solenoid

* Only available with voltage code "49" & override option "A", valve type "N" Only. Solenoid coil only CSA approved.

** Solenoid pilot type "D" & "N" only.

Voltage code "46" only.

‡ Valve type "N" Only. Solenoid coil only CSA approved.

† Solenoid pilot type "X" only.

§ Voltage code "B9" only. Valve type "N" only.

Overrides	
A**	No Override
B †	Flush - Non-Locking
C *	Flush - Locking
D	Extended Non-Locking
E †	Extended - Locking
X †	Valve Less 15mm Solenoid

* Override for valve type "N" only.

** Not available on enclosure "5", 15mm solenoid. Available solenoid pilot type "D" & "N" only.

† Available solenoid pilot type "X" only.

Solenoid Pilot Type	
D**	Vented Pilot Exhaust
N**	Tapped Pilot Exhaust
X*	15mm Solenoid Vented Pilot Exhaust

* Available enclosure "5", "X" and operator type "N" only.

** Not available on enclosure "5" & "X".

Operator Type / Operating Pressure and Temperature	
Normal, Vacuum to 145 PSIG (10 bar), 14°F to 122°F (-10°C to 50°C), CSA Approved	N
Xtreme, Vacuum to 145 PSIG (10 bar), -40°F to 140°F (-40°C to 70°C), CSA Approved	K
Xtreme, Vacuum to 232 PSIG (16 bar), -40°F to 140°F (-40°C to 70°C)	H*

* P2LC and P2LD solenoid operated valves have a maximum pressure rating of 175 PSIG (12 bar)

Most popular.



For inventory, lead times, and kit lookup, visit www.pdnplu.com

Part Numbers / Ordering Information

Remote Pilot Valves

Single Remote Pilot, 3-way, 2-position, Xtreme Operating Pressure / Temperature

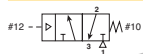

P2LAX Shown

Port Size (NPT)	Cv	Response Time (msec)	Weight lb (kg)	Valve Type	Part Number
1/8"	0.7	15 / 45	0.68 (0.31)	P2LAX	P2LAX391PS
1/4"	1.3	25 / 65	0.68 (0.31)	P2LBX	P2LBX392PS
3/8"	2.5	25 / 65	0.88 (0.40)	P2LCX	P2LCX393PS
1/2"	2.7	25 / 65	0.88 (0.40)	P2LDX	P2LDX394PS

Single Remote Pilot, 4-way, 2-position, Xtreme Operating Pressure / Temperature



P2LAX Shown

Port Size (NPT)	Cv	Response Time (msec)	Weight lb (kg)	Valve Type	Part Number
1/8"	0.7	15 / 45	0.33 (0.15)	P2LAX	P2LAX591PS
1/4"	1.3	20 / 55	0.68 (0.31)	P2LBX	P2LBX592PS
3/8"	2.5	25 / 85	0.90 (0.41)	P2LCX	P2LCX593PS
1/2"	2.7	25 / 85	0.90 (0.41)	P2LDX	P2LDX594PS

Double Remote Pilot, 4-way, 2-position, Xtreme Operating Pressure / Temperature

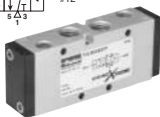

P2LBX Shown

Port Size (NPT)	Cv	Response Time (msec)	Weight lb (kg)	Valve Type	Part Number
1/8"	0.7	11 / 11	0.33 (0.15)	P2LAX	P2LAX591PP
1/4"	1.3	13 / 13	0.68 (0.31)	P2LBX	P2LBX592PP
3/8"	2.5	18 / 18	0.90 (0.41)	P2LCX	P2LCX593PP
1/2"	2.7	18 / 18	0.90 (0.41)	P2LDX	P2LDX594PP

Double Remote Pilot, 4-way, 3-position All Ports Blocked, 3-position Center Exhaust, Xtreme Operating Pressure / Temperature



P2LBX Shown

Port Size (NPT)	Cv	Response Time (msec)	Weight lb (kg)	Valve Type	Part Number	
					All Ports Blocked	Center Exhaust
1/8"	0.5	18 / 50	0.31 (0.14)	P2LAX	P2LAX691PP	P2LAX891PP
1/4"	0.9	25 / 65	0.73 (0.33)	P2LBX	P2LBX692PP	P2LBX892PP
3/8"	1.8	30 / 90	0.93 (0.42)	P2LCX	P2LCX693PP	P2LCX893PP
1/2"	1.9	30 / 90	0.93 (0.42)	P2LDX	P2LDX694PP	P2LDX894PP

Notes: Above valves are rated for an operating temperature from -40°F to 158°F (-40°C to 70°C). See model code matrix for additional options. Response time: Actuate to 90% pressure / return to exhaust to 10% of supply pressure. 93 PSIG (6.3 bar) / temperature 68°F (20°C).

Viking Xtreme Remote Air Pilot Operated Valves

P2L A X 5 91 PS

Operating information

Operating pressure:
(P2LAX & P2LBX)
Vacuum to 232 PSIG (Vacuum to 16 bar)
(P2LCX & P2LDX)
Vacuum to 174 PSIG (Vacuum to 12 bar)

Operating temperature:
-40°F to 158°F (-40°C to 70°C)

Valve Size	
1/8"	A
1/4"	B
3/8"	C*
1/2"	D*

* P2LCX and P2LDX manual & remote air pilot valves have a maximum pressure rating of 175 PSIG (12 bar).

Operators / Return	
PP	Double Remote Pilot
PS*	Single Remote Pilot, Spring Return

* Not available with 3-position valves.

Valve Type / Function	
3/2 NC - 2-Position	3
5/2 2-Position	5
5/3 3-Position, APB	6
5/3 3-Position, PC	7
5/3 3-Position, CE	8

Main Port Thread	
11	G1/8 (P2LA)
12	G1/4 (P2LB)
1N*	G1/4 NPT (P2LB) NAMUR Mount
13	G3/8 (P2LC)
14	G1/2 (P2LD)
91	1/8" NPT (P2LA)
92	1/4" NPT (P2LB)
9N*	1/4 NPT (P2LB) NAMUR Mount
93	3/8" NPT (P2LC)
94	1/2" NPT (P2LD)

* 5/2, 2-position valve only.

Most popular.



For inventory, lead times, and kit lookup, visit www.pdnplu.com

C
 Inline Valves
 Viking Lite
 Viking Xtreme
 B3, B5, B6 Series
 B7, B8 Series
 Air Saver Unit
 "N" Series

ATEX Certified Single & Double Solenoid Operated Valves

Viking ATEX valves meet ATEX directive 94/9/EC with the following classification : CE Ex II 2GD c 135oc. This directive lays down minimum safety requirements for products intended for use in potentially explosive atmospheres. The Directive is commonly referred to as the 'ATEX' Directive ('ATmospheres EXplosibles'), but may also be called the ATEX Equipment Directive or ATEX 95. Both ATEX certified solenoid, remote pilot and manual operated valves, as well as complete solenoid pilot assemblies are available.



ATEX classification details:

- CE Ex: fulfils the ATEX directive
- II : Group II Equipment Area
- 2GD : Equipment Category 2. Gas Zone 1,2 and Dust Zone 21,22
- c : Safe Design (EN13463-5)
- 135°C : Real temperature of the surface of product for test

Temperature Class of Solenoid : T4 135°C, ATEX 8-22T

Operating information

Operating pressure: Vacuum to 145 PSIG (vacuum to 10 bar)
 Operating temperature: 14°F to 122°F (-10°C to 50°C)

C
 Inline Valves
 Viking Lite
 Viking Extreme
 B3, B5, B6 Series
 B7, B8 Series
 Air-Saver Unit
 "N" Series

P2L A X 5 91 ES A D D M 49

Valve Size	
1/8"	A
1/4"	B
3/8"	C
1/2"	D

Voltage	
49	24VDC

Enclosures	
M	ATEX 8-22T EExm T4 135°C

Valve Type / Function		
Internal Pilot Supply To Solenoid		
2-Position Valve		5
3-Position Valve APB		6
3-Position Valve PC		7
3-Position Valve CE		8
External Pilot Supply to Solenoids Through Ports #12 & #14		
2-Position Valve		N
3-Position Valve APB		P
3-Position Valve PC		Q
3-Position Valve CE		R

Overrides	
D	Extended Non-Locking

Solenoid Pilot Type	
D	Vented Pilot Exhaust
N	Tapped Pilot Exhaust (M5)

Operator Return	
EE	Double Solenoid
ES*	Single Solenoid, Spring Return

* Not available with 3-position valves.

Main Port Thread	
G1/8 (P2LA)	11
G1/4 (P2LB)	12
G3/8 (P2LC)	13
G1/2 (P2LD)	14
1/8" NPT (P2LA)	91
1/4" NPT (P2LB)	92
3/8" NPT (P2LC)	93
1/2" NPT (P2LD)	94

NOTE:

- ATEX Valve includes a coil with sealed 3 meter cable.
- Replacement solenoid kit P2FS13A3DM49 includes coil with sealed 3 meter cable, valve armature, solenoid, solenoid nut, screws and o-rings.
- Can be mounted to size A, B or C IEM Bar Manifolds.

These products are designed for utilization in applications falling under the scope of ATEX Directive 94/9/EC. This coverage could only be referred to as long as operations required for the installation and the maintenance of these products are complying with related standards.



For inventory, lead times, and kit lookup, visit www.pdnplu.com

IEM Bar Manifold, Viking Xtreme Solenoid / Remote Pilot Valves †



Valve Series	Valve Function	## - Stations	Manifold Only (NPT)	Manifold Only (BSPP)
P2LAX*	3-way	02 - 12	P2LAXGAXN##NP	P2LAXGAXG##NP
P2LAX*	4-way	02 - 12	P2LAXMAXN##NP	P2LAXMAXG##NP
P2LBX*	3-way	02 - 12	P2LBXGAXN##NP	P2LBXGAXG##NP
P2LBX*	4-way	02 - 12	P2LBXMAXN##NP	P2LBXMAXG##NP
P2LCX*	3-way / 4-way	02 - 12	P2LCXMAXN##NP	P2LCXMAXG##NP

Kits include: (1) manifold, valve hold down bolts and o-rings. Replace ## with number of valve stations. Valve size A, B, C only.

* Enclosure option A,E & F can not be mounted on size A & B manifolds and enclosure F can not be mounted on size C manifolds due to width of solenoid,

Enclosure option A & E can be mounted on size A & B manifolds if valve is a single solenoid valve and if every other valve is mounted in reverse (staggered).

† Consider Viking Lite manifolds for alternative solutions.

IEM Bar Manifold Add-A-Fold Assembly (Viking Xtreme Solenoid / Remote Air Pilot Valves Only)



Valve Series	Valve Function	## - Stations	Manifold Only (NPT)	Manifold Only (BSPP)
P2LAX*	3-way	02 - 12	AAP2LAXGAXN##NP	AAP2LAXGAXG##NP
P2LAX*	4-way	02 - 12	AAP2LAXMAXN##NP	AAP2LAXMAXG##NP
P2LBX*	3-way	02 - 12	AAP2LBXGAXN##NP	AAP2LBXGAXG##NP
P2LBX*	4-way	02 - 12	AAP2LBXMAXN##NP	AAP2LBXMAXG##NP
P2LCX*	3-way / 4-way	02 - 12	AAP2LCXMAXN##NP	AAP2LCXMAXG##NP

Kits include: (1) manifold, valve hold down bolts, o-rings and assembly. Replace ## with number of valve stations. Valve size A, B, C only.

* Enclosure option A,E & F can not be mounted on size A & B manifolds and enclosure F can not be mounted on size C manifolds due to width of solenoid,

How to Order: 1. List Add-A-Fold assembly part number as line item 1

2. List the desired valves series part number in subsequent line items after the Add-A-Fold Assembly part number to complete the ordering code. Include all valves and blanking kits required. The left most station is station # 1 looking at the #12 end of the manifold.

Example: Viking Size B, 2 Station manifold, with 2, 4-way single solenoid valves

Line	Qty	Part number	Comment
1	1	AAP2LBXMAXN02NP	Add-A-Fold Assembly, 2-station IEM bar manifold
2	2	P2LBX592ESHDDB49	4-way, Station 1, 2

Blanking Plate

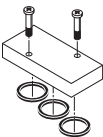

Type	Kit Number
P2LAX 4-way	9121658063
P2LBX 4-way	9121594809X
P2LCX 3 & 4 way	P2LCXK20P
P2LAX 3-way	912132BPSXZ
P2LBX 3-way	912132BPSXZ

Kit includes: plate, screws, o-rings

Manifold Bolts

Type	Qty.	Kit Number
P2LAX	12	P2LAXK87P
P2LBX	12	P2LBXK87P
P2LCX	12	P2LCXK87P

Manifold O-rings

Type	Qty.	Kit Number
P2LAX	30	P2LAXK84P
P2LBX	18	P2LBXK84P
P2LCX	12	P2LCXK84P

Most popular.



For inventory, lead times, and kit lookup, visit www.pdnplu.com

Solenoids with Deutsche Connections : Environmentally-Sealed Transportation Connectors

Viking valves with solenoid options “T” & “V” include a grommet lead wire solenoid with internal surge suppression connected to Deutsche DTP Series male connectors. Heat shrunk cover holds the grommet lead wires together between the solenoid and deutsche connector. An environmentally-sealed connector designed specifically for cable to cable applications in harsh environments such as on the engine or transmission, under the hood, on the chassis or in the cab applications. On signal

level circuits where even a small degradation in connection may be critical, these connectors will provide the reliability and performance when properly connected to DTP female connector assemblies. Thermoplastic housings with silicone seals are used to allow the connector to withstand conditions of extreme temperature and moisture. Properly wired and mated connection will withstand immersion under three feet of water without loss of electronic qualities or leakage.

Deutsche Connector & Solenoid Information

		“T” Single Solenoid Option	“V” Double Solenoid Option
Solenoid Kit		P2FCT446	P2FCV446
Connector Information	Housing material	Thermoplastic	Thermoplastic
	Grommet seal material	Silicone	Silicone
	Connector housing / seal number	DT04-2P*	DT04-4P*
	Contact material	Copper alloy	Copper alloy
	Contact number	0460-202-16141*	0460-202-16141*
	Sealing plug (Wedge) material	Thermoplastic	Thermoplastic
	Wedge number	W2P*	W4P*
	Temperature rating of connector	-67°F (-55°C) to +257°F (+125°C)	-67°F (-55°C) to +257°F (+125°C)
Solenoid	Voltage	12VDC +10%, -30% mobile with bi-directional surge suppression	12VDC +10%, -30% mobile with bi-directional surge suppression
	Number of solenoids	1	2
	Connector pin out	pin 1 & 2	12 solenoid : pin 1 & 2 14 solenoid : pin 3 & 4
	Wire length (Connector to solenoid)	19" (483mm)	12 Solenoid : 19" (482mm) 14 Solenoid : 7.75" (196.5mm)
	Exposed insulated wire (a)	0.25" (6.4mm) - 0.5" (12.7mm)	0.25" (6.4mm) - 0.5" (12.7mm)
	Exposed insulated wire (b)	0.75" (19.1mm) - 1.5" (38.1mm)	0.75" (19.1mm) - 1.5" (38.1mm)
	Wire cover material	Heat shrunk PVC	Heat shrunk PVC

* Deutsche Industrial reference numbers. Male connections provided, mating female components and assemblies can be sourced from qualified Deutsche connector distributors.

Enclosure / Lead Length - Option “T”



Solenoid Kit P2FCT446 shown

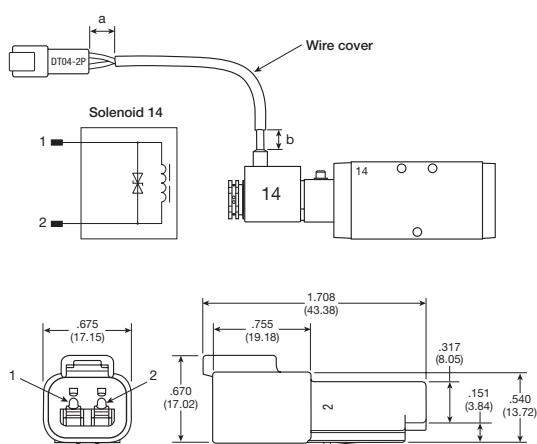

Enclosure / Lead Length - Option “V”



Solenoid Kit P2FCV446 shown

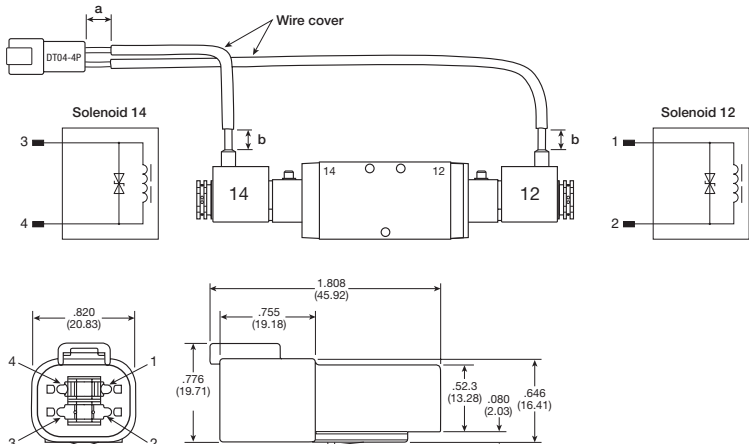

Pilot Operator Kits

P2FP13 N 4 C

Type	Overrides
Pilot Operator Kit P2FP13	A No override
	C* Locking (bistable) Flush - Plastic
	D Non-Locking (monostable) Extended - Brass

* Only available with "N" Pressure / Temperature option.

Pressure / Temperature	
145 PSIG (10 bar) 14°F to 122°F (-10°C to 50°C)	N
232 PSIG (16 bar) -40°F to 158°F (-40°C to 70°C)	H

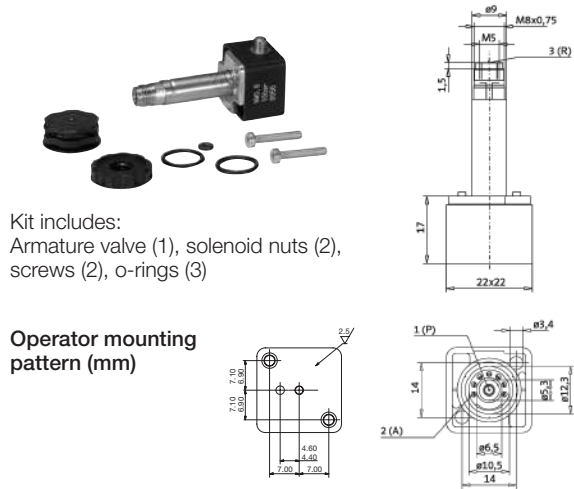

Kit includes:
 Armature valve (1), solenoid nuts (2), screws (2), o-rings (3)

Operator mounting pattern (mm)

Solenoid Pilot Operators & Coils

Solenoid pilot options

The P2FP13*4* (NC) 3/2 solenoid pilot operators are designed for piloting pneumatic control valves with compressed air or other inert gases.

The P2FP operator is available for Normal operating pressures up to 10 bar or the Xtreme maximum operating pressure of 16 bar and wide band voltage tolerances required for mobile applications.

Corrosion resistant design

The pilot valve body is manufactured in thermoplastic PA6 material and the core tube brass / stainless steel. The plunger / core is made from stainless steel and the valve seats from FKM.

Solenoid pilot exhaust

These operators all exhaust out of the top of the core tube which is tapped M5. The standard solenoid nut (Solenoid pilot type "D") fitted to the core tube is a diffuser nut which allows the exhaust to escape to atmosphere. This not also minimizes ingress of dirt into the valve through this port. The alternative plastic knurled nut (Solenoid pilot type "N") can be specified (refer to part number system) if the exhaust air needs captured and piped away using the M5 tapped port.

Mobile applications

Viking Xtreme valves are tested to +5g shock and vibration. Solenoid operated valves are designed to operate with wide voltage tolerance bands within the ambient temperature ranges stated in the technical section.

Coils

Coils are wound with enameled copper wire, having a temperature index of 180°C with class F insulation (155°C) and are encapsulated in Thermoplastic resin. When fitted with suitable connector and correct gasket, they give protection to IP65.

 Most popular.

Manual override options

The pilot operators can be supplied with locking or non-locking manual override. The standard manual override is the monostable (spring return) extended brass override. Alternatively the bistable (locking) override can be specified as an alternative for the Normal duty 10 bar option.

Spares

Solenoid operators are available as spares complete with mounting screws and seals. Coils and connectors should be ordered separately unless ATEX certified and intrinsically safe is needed. ATEX certified operators and coils must be ordered together.

Transients

Interrupting the current through the solenoid coil produces momentary voltage peaks which, under unfavorable conditions, can amount to several hundred times the rated operating voltage. Normally, these transients do not cause problems, but to achieve the maximum life of relays in the circuit (and particularly of transistors, thyristors and integrated circuits) it is desirable to provide protection by means of voltage-dependent resistors (varistors). All connectors / cable plugs with LEDs include this type of circuit protection.

Materials

Pilot Valve	
Body	Polyamide
Armature tube:	
Normal pilot operator	Brass
Xtreme pilot operator.....	Stainless steel
Plunger & core.....	Corrosion resistant CR-NI steel
Seals	FKM
Screws	Stainless steel
Coil	
Encapsulation material.....	Thermoplastic



For inventory, lead times, and kit lookup, visit www.pdnplu.com

Solenoid Kits

Solenoid Enclosures

P2FC B 4 49

Type	
Solenoid Kit	C

	Voltage
B9 ‡	24 VDC w/ Surge Suppression & LED
42	24VAC
45	12VDC
46 †	12 VDC Mobile w/ surge Suppression
47*	12 VDC Mobile
48*	24 VDC Mobile
49	24VDC
53	120VAC
57	240VAC

Enclosures / Lead Length	
M12 4-Pin Coil With Surge Suppression & LED	7 §
30mm Square 3-Pin – ISO 4400 Form A (male only)	A
22mm Rectangular 3-Pin – Type B Industrial (male only)	B
Hazardous duty, FM / CSA	F*
Grommet - 18" Leads	G
1/2" NPT Conduit - 18" Leads	H
Grommet, Single Solenoid, 2-Pin Deutsche Connector, Surge Suppression	T #
Grommet, Double Solenoid, 4-Pin Deutsche Connector, Surge Suppression	V #
Grommet 72" Leads	Q
1/2" Conduit 72" Leads	R

* Only available with voltage codes "45", "49", "53" & "57". Not for use with the Xtreme version (-40°C to 70°C).

Voltage code 46 only.

§ Voltage code B9 only.

* Only available with enclosures "A", "B" & "G". Additional voltages are available upon request. Contact customer support for more information.

‡ Enclosure 7 only

† Enclosure G, T, V only.



Option 7
 M12, 4-Pin Coil with Surge Suppression



Option A
 30mm Square, 3-Pin ISO 4400, DIN 43650A



Option B
 22mm Rectangular, 3-Pin DIN, Type B Industrial



Option G & Q
 Grommet, 18" or 72" Leads



Option H & R
 1/2" Conduit, 18" or 72" Leads

Solenoid Kits – 3-Pin, EN175301-803 (Former DIN 43650C), 15mm, 8mm



Standard

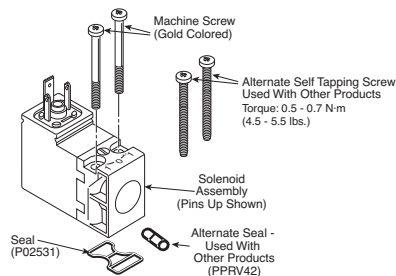

PS2982*##P – Enclosure '5'

* Override	## Voltage						
	42	45	47 †	48 †	49	53	57
B	O	O	S	S	S	S	O
C	O	O	S	S	S	S	O
D	O	O	O	O	O	O	O
E	O	O	O	O	O	O	O

S - Standard; O - Option

† Mobile voltage

Kit includes: Solenoid, (2) machine screws, (2) self threading screws, (1) gasket, (1) 3-cell gasket.

Solenoid Information (Solenoids are rated for continuous duty.)

Voltage	Enclosure "5"			Enclosure "A"		Enclosure "7", "B" to "R"	
	AC 60Hz	AC 50Hz	DC	Power Consumption	Holding (Amps)	Power Consumption	Holding (amps)
B9 †	w	—	24	—	—	—	—
42	24	22	—	1.6VA	.065	3.9VA	.14
45	—	—	12	1.2W	.098	2.6W	.21
46 † †	—	—	12	—	—	—	—
47*	—	—	12	0.91W	.074	6.2W	.52
48*	—	—	24	0.91W	.033	6.8W	.29
49	—	—	24	1.2W	.049	2.7W	.11
53	120	110	—	1.6W	.013	4.1VA	.04
57	240	230	—	1.6W	.007	3.7VA	.02

* Mobile voltages. † Surge suppression.

■ Most popular.



For inventory, lead times, and kit lookup, visit www.pdnplu.com

Intrinsically safe solenoid valves (“E” option)

Hazardous location class:

Class I; Groups A, B, C & D

Class II; Groups E, F, & G

Class III; Div. I

For use in low voltage (24VDC) Intrinsically Safe applications.
 NO OTHER VOLTAGE IS APPROVED.

Comes standard with non-lighted solenoid connector.

Coil width: 30mm

Must be connected to an FM approved Barrier.

For dimensions, reference standard solenoid models.

Maximum internally piloted valve pressure is 115 PSIG.

Pressures to 145 PSIG can be used when external pilot is utilized and pilot pressure is limited to 115 PSIG.

The intrinsically safe coil width (30mm) is wider than the body width of valve type A & B valves. If mounted on a manifold, the valves need to be staggered to fit and must be single solenoid valves only.

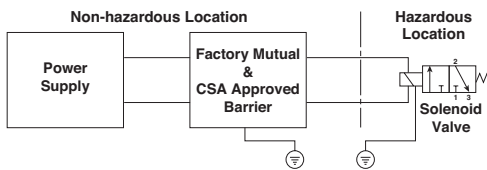

Intrinsically safe solenoid pilot assembly kits

Description	Part number
24VDC	P2FS13N1AE49

Kit includes: coil, armature, connector, o-ring & screws

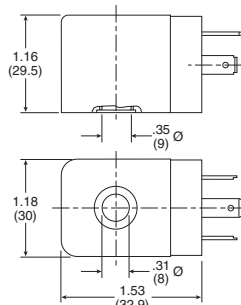

Hazardous duty solenoid valves (“F” option)

Hazardous location class:

Class I; Zone I EX, M, II & T4

Class I; Div. I, Groups A, B, C, & D

Class II & III; Div. I, Groups E, F, & G

Comes standard with 1/2" conduit connection.

Coil width: 36mm

Voltage range = ±10%

Ambient temperature range = -20°C (-4°F) to 60°C (140°F)

Duty factor = 100%

IP65 Rated (with connected conduit connector)

Notes:

1. Maximum non-hazardous location voltage not to exceed 250V RMS.
2. Factory Mutual requires connections per ISA RP 12.6 instructions.
3. CSA requires “Installation to be in accordance with the Canadian Electrical Code, Part I.”
4. The hazardous duty coil width (36mm) is wider than the body width of valve type A, B, C & D valves. Valves can not be mounted to IEM manifolds without installing a blanking plate between valves.

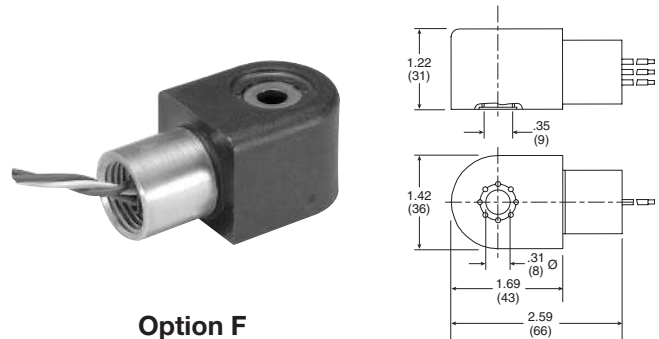

**Option F
 Hazardous Duty FM / CSA**

M12, 24VDC solenoid coil (“7” option)

Connection type: M12, metal thread, M12 x 1

DIN EN 60947-5-2 appendix D

LED color: yellow

Bi-directional surge suppression

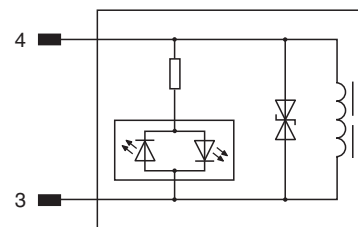
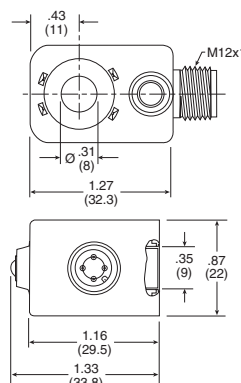

1. Not Used
2. Not Used
3. +/- (blue)
4. +/- (black)

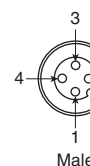

**4-Pin Female Wiring Diagram
 (only Pins 4 & 3 are used)
 Per ISO 20401**

Internal to external pilot conversion (size A & B only)

To convert from Internal to External Pilot Valve, simply remove the (2) fasteners that attach the end cap to the valve body. Rotate the end cap 180° and attach back to the valve body. For single solenoid valves, only the 14-End needs to be rotated. For double solenoid valves, both ends must be converted for proper function.

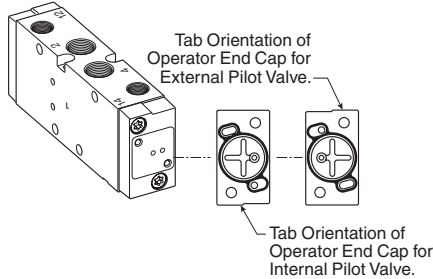

The 12 & 14-Ports are always tapped no matter what Valve Type / Function is selected. For Internal Pilot Function, ports do NOT need to be plugged.

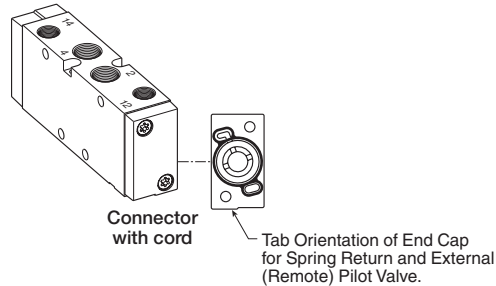

**22mm Rectangular 3-Pin – Type B Industrial
 (Use with Enclosure “B”)**

Description	Connector with 6' (2m) Cord	Connector
Unlighted	PS2429JBP	PS2429BP
Light – 24V/60Hz, 24VDC	PS2430J79BP*	PS243079BP
Light – 120V/60Hz	PS2430J83BP*	PS243083BP
Light – 240V/60Hz	N/A	PS243087BP

* LED with surge suppression.

Note: Max ø6.5mm cable size required for connector w/o 6' (2m) cord. IP65 rated when properly installed.

Engineering Data:

Conductors: 2 Poles Plus Ground; Cable Range (Connector Only): 6 to 8mm (0.24 to 0.31 Inch); Contact Spacing: 11mm

M12 A-code Cables

Description	Part Number
4-Pin female to flying lead cable, PVC, 2m	RKC 4.4T-2

RKC Female Sockets

* Only pins 3 and 4 are used with solenoids Option "7".

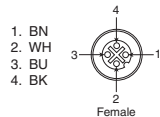
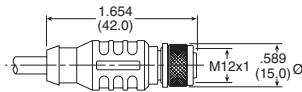

4-Pin Female Wiring Diagram

15mm Solenoid Mount

Description	Part Number
15mm solenoid mount	P2FA22-15



Kit includes: adapter (1), O-rings (2), gasket (1), screws (4)

 Most popular.

**15mm 3-Pin DIN 43650C
 (Use with Enclosure “5”)**

Description	Cord Length	Connector	Connector only	Connector with Cord
Unlighted	18 Inches	PS2932BP	PS2932BP	PS2932HBP
Unlighted	6 Feet	PS2932BP	PS2932BP	PS2932JBP
Light – 12VAC or DC	6 Feet	PS294675BP	PS294675BP	PS2946J75BP*
Light – 24VAC or DC	6 Feet	PS294679BP	PS294679BP	PS2946J79BP*
Light – 110/120VAC	6 Feet	PS294683BP	PS294683BP	PS2946J83BP*
Light – 240/230VAC		PS294687BP	N/A	N/A

* LED with surge suppression.

Note: Max ø6.5mm cable size required for connector w/o 6' (2m) cord. IP65 rated when properly installed.

Engineering data:

Conductors: 2 poles plus ground Cable range (connector only): 4 to 6mm (0.16 to 0.24 Inch) Contact spacing: 8mm

**30mm Square 3-Pin – ISO 4400, DIN 43650A
 (Use with Enclosure “A”)**

Description	Connector with 6' (2m) Cord	Connector
Unlighted	PS2028JCP	PS2028BP
Light – 6-48V, 50/60Hz, 6-48VDC	PS2032J79CP*	PS203279BP
Light – 120V/60Hz	PS2032J83CP*	PS203283BP

* LED with surge suppression.

Note: Max ø6.5mm cable size required for connector w/o 6' (2m) cord. IP65 rated when properly installed.

Engineering data:

Conductors: 2 poles plus ground; cable range (connector only): 8 to 10mm (0.31 To 0.39 Inch); contact spacing: 18mm

Replacement Solenoid Nut

Description	Part Number	Description	Part Number
Solenoid diffuser nut	PS1556	Solenoid vented nut	PS2892P



For inventory, lead times, and kit lookup, visit www.pdnplu.com

It is the users responsibility to verify product performance when applied at maximum tolerance ranges of multiple technical specifications simultaneously.

Operating temperature

- **Normal**.....14°F to 122°F (-10°C to 50°C)
- **Xtreme**..... -40°F to 158°F (-40°C to 70°C)

Flow Rating

Valve Size	Port Size	2-Position	3-Position
P2LAX	1/8"	0.7	0.5
P2LBX	1/4"	1.3	0.9
P2LCX	3/8"	2.5	1.8
P2LDX	1/2"	2.7	1.9

Operating pressure*

Maximum: Normal.....145 PSIG (10 bar)
Xtreme.....232 PSIG (16 bar)

Minimum:

Valve Type - Internal Pilot	Minimum PSIG (bar)			
	P2LAX	P2LBX	P2LCX	P2LDX
Single solenoid - spring return	46 (3.2)	51 (3.5)	51 (3.5)	51 (3.5)
Single remote pilot - spring return	46 (3.2)	51 (3.5)	51 (3.5)	51 (3.5)
Double solenoid - 2-position	22 (1.5)	22 (1.5)	22 (1.5)	22 (1.5)
Double remote pilot - 2-position	22 (1.5)	22 (1.5)	22 (1.5)	22 (1.5)
Double solenoid - 3-position (APB, PC, CE)	51 (3.5)	51 (3.5)	51 (3.5)	51 (3.5)
Double remote pilot - 3-position (APB, PC, CE)	51 (3.5)	51 (3.5)	51 (3.5)	51 (3.5)

Valve Type - External Pilot	P2LAX	P2LBX	P2LCX	P2LDX
All Viking series	Vacuum			

* P2LC and P2LD solenoid operated valves have a maximum pressure rating of 175 PSIG (12 bar).

Size A and B solenoid valves can be field converted from internal pilot to external pilot and visa versa. See previous page for information.

Solenoid voltage characteristics

Non-Mobile Coil -

Voltage Code 42, 45, 49, 53, 57

15mm, DIN 43650C (Enclosure: 5)
 +10%, -15%

Mobile Coil -

Voltage Code 47, 48

15mm, Din 43650C (Enclosure: 5)
 +25%, -30%

Voltage Code 46

(Enclosure G,T,V)
 +10%, -30%

Inline Valve Products, Viking Xtreme Viking Xtreme Series

Solenoid voltage characteristics

Non-mobile coils -

Voltage code B9, 42, 45, 49, 53, 57

Enclosure (7, A, B, E, F, G, H)
 +10%, -10%

Mobile coils - (valve type N)

22mm 12 & 24VDC - Mobile (47 & 48 voltage code)

Operating Temperature			
Minimum inlet pressure (bar)	-10°C	+10°C	+50°C
3	+30 / -25% VDC	+30 / -20% VDC	+25 / -15% VDC
6	+30 / -30% VDC	+30 / -25% VDC	+25 / -20% VDC
8	+30 / -30% VDC	+30 / -30% VDC	+25 / -25% VDC
10	+30 / -30% VDC	+30 / -30% VDC	+25 / -30% VDC

30mm 12 & 24VDC - Mobile (47 & 48 voltage code)

Operating Temperature			
Minimum inlet pressure (bar)	-10°C	+10°C	+50°C
3	+30 / -30% VDC	+30 / -30% VDC	+25 / -30% VDC
6	+30 / -30% VDC	+30 / -30% VDC	+25 / -30% VDC
8	+30 / -30% VDC	+30 / -30% VDC	+25 / -30% VDC
10	+30 / -30% VDC	+30 / -30% VDC	+25 / -30% VDC

Mobile coils - (valve type K & H)

22mm 12 & 24VDC - Mobile (47 & 48 voltage code)

Operating Temperature				
Minimum inlet pressure (bar)	-40°C	+10°C	+50°C	+70°C
4	+30 / -25% VDC	+30 / -25% VDC	+30 / -10% VDC	+20 / -10% VDC
8	+30 / -30% VDC	+30 / -25% VDC	+30 / -15% VDC	+20 / -15% VDC
12	+30 / -30% VDC	+30 / -30% VDC	+30 / -15% VDC	+20 / -15% VDC
16	+30 / -30% VDC	+30 / -30% VDC	+30 / -20% VDC	+20 / -20% VDC

30mm 12 & 24VDC - Mobile (47 & 48 voltage code)

Operating Temperature				
Minimum inlet pressure (bar)	-40°C	+10°C	+50°C	+70°C
4	+30 / -30% VDC	+30 / -30% VDC	+25 / -30% VDC	+15 / -30% VDC
8	+30 / -30% VDC	+30 / -30% VDC	+25 / -30% VDC	+15 / -30% VDC
12	+30 / -30% VDC	+30 / -30% VDC	+25 / -30% VDC	+15 / -30% VDC
16	+30 / -30% VDC	+30 / -30% VDC	+25 / -30% VDC	+15 / -30% VDC

Note: All table ratings are based on 100% continuous duty and 5G shock vibration. At 50% continuous duty all ratings are +30% / -30% for all Temperatures and Pressures.

C

Inline Valves

Viking Lite

Viking Xtreme

B3, B5, B6 Series

B7, B8 Series

Air Saver Unit

"N" Series



For inventory, lead times, and kit lookup, visit www.pdnplu.com

Exhaust Protector

Features

- 1/8 and 1/4 NPT male sizes
- Fitted with a brass pipe adapter and a fluorocarbon membrane
- Resistant to rust, clog, wash down and contamination

Applications

These protectors are intended for mobile applications, quick venting applications and alternative exhaust port breathers that require protection against clogging.

Ideal for valves exposed to harsh environmental conditions (which can cause a "caking up" in the exhaust pipe ports where the bronze mufflers or breather vents are installed).

Particularly suitable for time-sensitive applications such as axle-lift suspensions or pushers or tag axles.

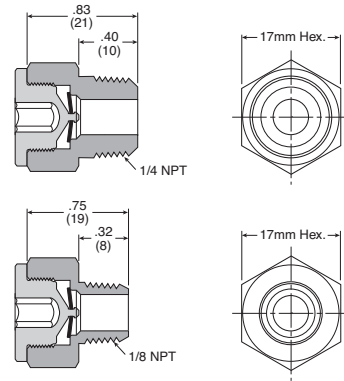

Operating information

Operating pressure:	0 to 150 PSIG (0 to 10 bar)
Operating temperature:	-40°F to 140°F (-40°C to 60°C)

Flow data (SCFM)

Size	60 PSIG Inlet	90 PSIG Inlet	125 PSIG Inlet	Part Number
1/8"	40.1	56.5	75.5	E90016
1/4"	44.6	62.7	83.5	E90017

Material specifications

Body & pipe adapter	Brass
Membrane	Fluorocarbon

Exhaust Mufflers

Pipe Thread	Part Number
M5	P6M-PAC5
1/8" NPT	EM12
1/4" NPT	EM25
3/8" NPT	EM37
1/2" NPT	EM50

P6M - Plastic; EM - Sintered bronze



Plastic Silencers

Thread Size	A (mm)	B (mm)	Part Number		
			NPT	BSPT	Metric
M5	.43 (11)	.32 (8)	-	-	AS-5
1/8"	1.57 (40)	.63 (16)	ASN-6	AS-6	-
1/4"	2.56 (65)	.83 (21)	ASN-8	AS-8	-
3/8"	3.35 (85)	.98 (25)	ASN-10	AS-10	-
1/2"	3.74 (95)	1.18 (30)	ASN-15	AS-15	-



C
 Inline Valves
 Viking Lite
 Viking Extreme
 B3, B5, B6 Series
 B7, B8 Series
 Air-Saver Unit
 "N" Series

Spool Service Kits

Description	Includes Items (qty.)	Part Number
Size A, 4-way, 2-position, solenoid & air pilot valves	1 (1), 3 (2), 4 (2)	P2LAXSK1
Size A, 4-way, 3-position, solenoid & air pilot valves	1 (1), 2 (2), 3 (2), 4 (2)	P2LAXSK2
Size A & Size B, 3-way, 2-position, solenoid & air pilot valves	1 (1), 3 (2), 4 (2)	P2LAXBXSK1
Size B, 4-way, 2 & 3-position valves	1 (1), 3 (2), 4 (2)	P2LBXSK1
Size C & Size D, 3-way, 2-position valves	1 (1), 3 (2), 4 (2)	P2LCXDXXSK1
Size C & Size D, 4-way, 2 & 3-position valves	1 (1), 3 (2), 4 (2)	P2LCXDXXSK1

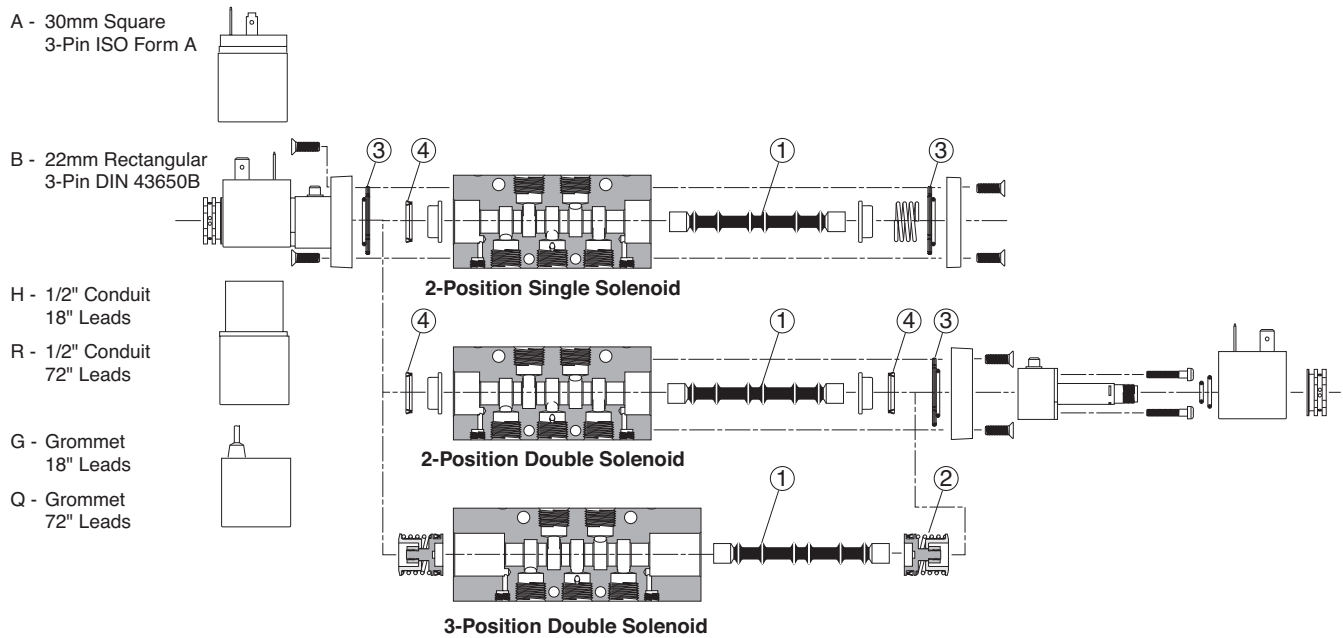

C
Inline Valves
Viking Lite
Viking Xtreme
B3, B5, B6 Series
B7, B8 Series
Air Saver Unit
"N" Series

P2LAX 3/2 Single & Double Operators – Solenoid

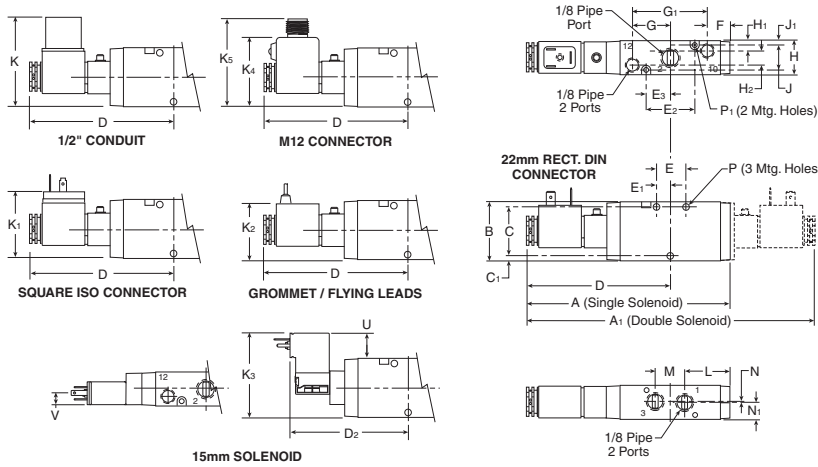

P2LAX 3/2 (solenoid)

A	A1	B	C	C1	D
5.35 (136)	7.60 (193)	1.57 (40)	1.26 (32)	.16 (4)	3.80 (97)
D2	E	E1	E2	E3	F
3.00 (76.8)	.79 (20)	.39 (10)	1.26 (32)	.63 (16)	.55 (14)
G	G1	H	H1	H2	J
.98 (25)	1.97 (50)	.87 (22)	.26 (6.6)	.35 (9)	.65 (16.5)
J1	K	K1	K2	K3	K4
.11 (2.9)	2.36 (60)	1.61 (41)	1.50 (38)	2.24 (57)	1.70 (43.3)
K5	L	M	N	N1	P
2.10 (53.3)	1.14 (29)	.79 (20)	.02 (0.5)	.42 (11)	Ø .17 Ø (4.3)
P1	U	V			
Ø .12 Ø (3.1)	0.81 (20.5)	0.29 (7.5)			

Inches (mm)

P2LAX 3/2 Single & Double Operators – Remote Air Pilot

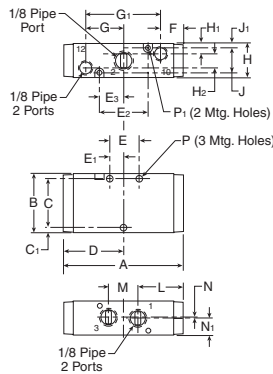

P2LAX 3/2 (remote air pilot)

A	B	C	C1	D	E
3.07 (78)	1.57 (40)	1.26 (32)	.16 (4)	1.54 (39)	.79 (20)
E1	E2	E3	F	G	G1
.39 (10)	1.26 (32)	.63 (16)	.55 (14)	.98 (25)	1.97 (50)
H	H1	H2	J	J1	L
.87 (22)	.26 (6.6)	.35 (9)	.65 (16.5)	.11 (2.9)	1.14 (29)
M	N	N1	P	P1	
.79 (20)	.02 (0.5)	.42 (11)	Ø .17 Ø (4.3)	Ø .12 Ø (3.1)	

Inches (mm)

P2LAX 5/2 & 5/3 Single & Double Operators, 4-way

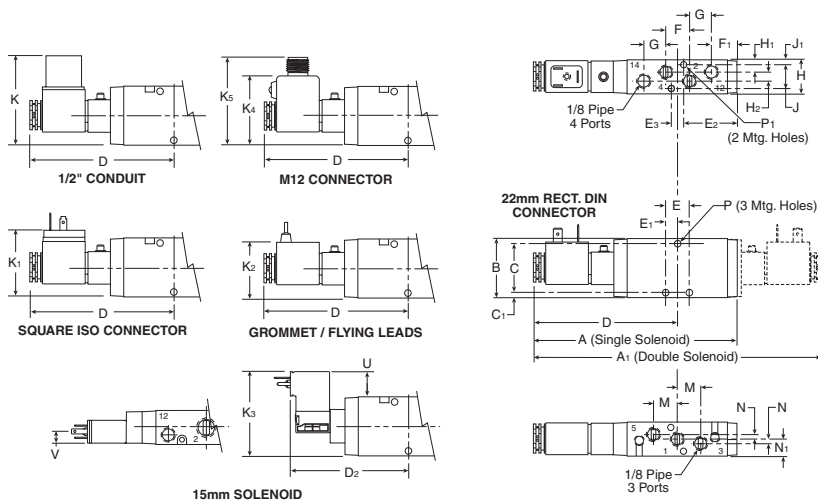

P2LAX 5/2 & 5/3 (solenoid)

A	A1	B	C	C1	D
5.47 (139)	7.72 (196)	1.57 (40)	1.30 (33)	.14 (3.5)	3.86 (98)
D2	E	E1	E2	E3	F
3.48 (88.3)	.63 (16)	.31 (8)	1.42 (36)	.33 (8.5)	.63 (16)
F1	G	H	H1	H2	J
.67 (17)	.59 (15)	.87 (22)	.31 (8)	.24 (6)	.63 (16)
J1	K	K1	K2	K3	K4
.12 (3.9)	2.36 (60)	1.61 (41)	1.50 (38)	2.24 (57)	1.63 (41.3)
K5	M	N	N1	P	P1
2.10 (53.3)	.63 (16)	.12 (3)	.43 (11)	Ø .17 Ø (4.3)	Ø .12 Ø (3.1)
U	V				
0.81 (20.5)	0.29 (7.5)				

Inches (mm)



For inventory, lead times, and kit lookup, visit www.pdnplu.com

P2LAX 5/2 & 5/3 Single & Double Operators – Remote Pilot

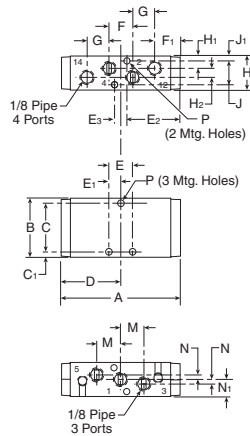

P2LAX 5/2 & 5/3 (remote)

A	B	C	C ₁	D
3.19 (81)	1.57 (40)	1.30 (33)	.14 (3.5)	1.59 (40.5)
E	E ₁	E ₂	E ₃	F
1.47 (16)	.31 (8)	1.42 (36)	.33 (8.5)	.63 (16)
F ₁	G	H	H ₁	H ₂
.67 (17)	.59 (15)	.87 (22)	.31 (8)	.24 (6)
J	J ₁	M	N	N ₁
.63 (16)	.12 (3)	.63 (16)	.12 (3)	.43 (11)
P	P ₁			
Ø .17 Ø (4.3)	Ø .12 Ø (3.1)			

Inches (mm)

P2LAX 3/2 Single & Double Operators – IEM Aluminum Bar Manifold

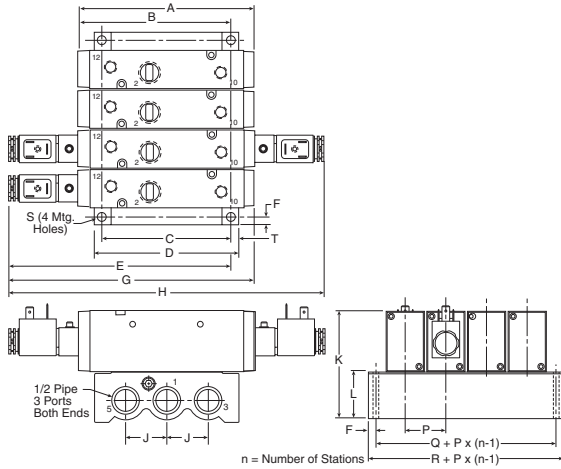

**P2LAX 3/2
 IEM Aluminum bar manifold**

A	B	C	D	E
3.07 (78)	2.83 (72)	2.76 (70)	3.12 (79)	5.18 (132)
F	G	H	J	K
41 (10.5)	5.35 (136)	7.72 (193)	.87 (22)	3.11 (79)
L	M	N	P	Q
1.54 (39)	.87 (22)	.52 (13.2)	.93 (23.5)	1.56 (39.5)
R	S	T		
2.36 (60)	Ø .22 Ø (5.5)	.18 (4.5)		

Inches (mm)

P2LAX 5/2 & 5/3 Single & Double Operators – IEM Aluminum Bar Manifold

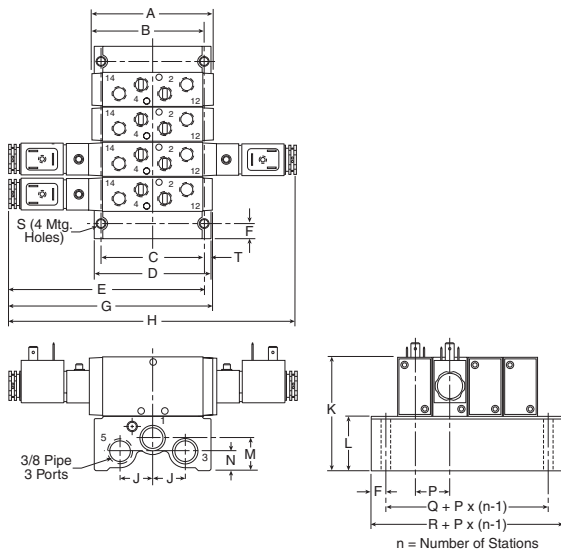

**P2LAX 5/2 & 5/3
 IEM Aluminum bar manifold**

A	B	C	D	E
3.19 (81)	2.97 (76)	2.76 (70)	3.12 (79)	5.26 (134)
F	G	H	J	K
41 (10.5)	5.47 (139)	7.72 (196)	.87 (22)	3.11 (79)
L	M	N	P	Q
1.54 (39)	.87 (22)	.52 (13.2)	.93 (23.5)	1.56 (39.5)
R	S	T		
2.36 (60)	Ø .22 Ø (5.5)	.18 (4.5)		

Inches (mm)

C

Inline Valves

Viking
 Lite

Viking
 Xtreme

B3, B5, B6
 Series

B7, B8
 Series

Air Saver
 Unit

"N"
 Series



For inventory, lead times, and kit lookup, visit www.pdnplu.com

C31

Parker Hannifin Corporation
 Pneumatic Division
 Richland, Michigan
www.parker.com/pneumatics

P2LBX 3/2 Single & Double Operators – Solenoid

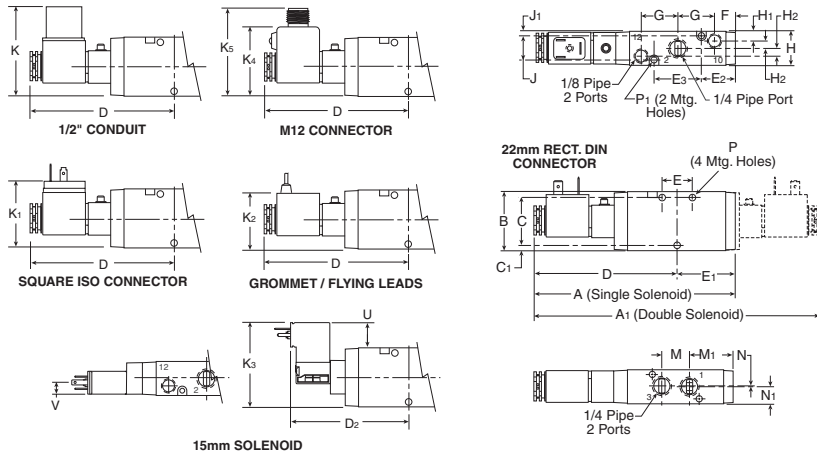

P2LBX 3/2 (solenoid)

A 5.35 (136)	A1 7.60 (193)	B 1.57 (40)	C 1.26 (32)	C1 .16 (4)	D 3.80 (96.5)
D2 3.02 (76.8)	E .79 (20)	E1 1.54 (39)	E2 .51 (13)	E3 1.26 (32)	F .55 (14)
G .98 (25)	H .87 (22)	H1 .26 (6.6)	H2 .18 (4.5)	J .65 (16.5)	J1 .11 (2.9)
K 2.36 (60)	K1 1.61 (41)	K2 1.50 (38)	K3 2.24 (57)	K4 1.63 (41.3)	K5 2.10 (53.3)
M .79 (20)	M1 1.14 (29)	N .02 (0.5)	N1 .42 (11)	P Ø .17 Ø (4.3)	P1 Ø .12 Ø (3.1)
U 0.81 (20.5)	V 0.29 (7.5)				

Inches (mm)

P2LBX 3/2 Single & Double Operators – Remote Air Pilot

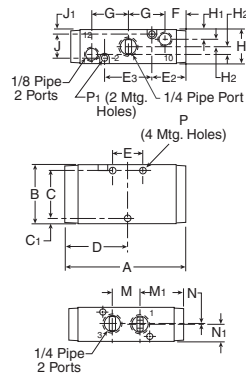

P2LBX 3/2 (remote air pilot)

A 3.08 (78)	B 1.57 (40)	C 1.26 (32)	C1 .16 (4)	D 1.54 (39)	E .79 (20)
E2 .51 (13)	E3 1.26 (32)	F .55 (14)	G .98 (25)	H .87 (22)	H1 .26 (6.6)
H2 .18 (4.5)	J .65 (16.5)	J1 .11 (2.9)	M .79 (20)	M1 1.14 (29)	N .02 (0.5)
N1 .42 (11)	P Ø .17 Ø (4.3)	P1 Ø .12 Ø (3.1)			

Inches (mm)

P2LBX 5/2 & 5/3 Single & Double Operators – Solenoid

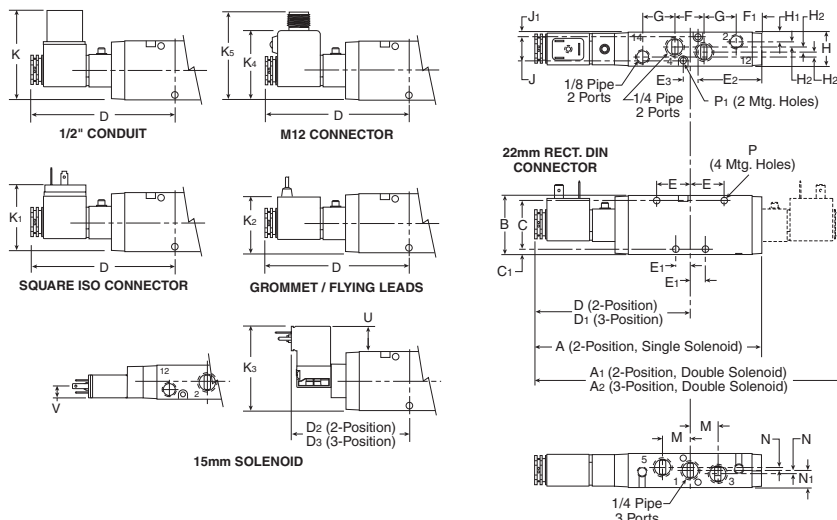

P2LBX 5/2 & 5/3 (solenoid)

A 6.14 (156)	A1 8.39 (213)	A2 9.23 (235)	B 1.57 (40)	C 1.26 (32)	C1 .16 (4)
D 4.21 (107)	D1 4.64 (118)	D2 3.48 (88.3)	D3 3.92 (99.6)	E .91 (23)	E1 .39 (10)
E2 1.73 (44)	E3 .39 (10)	F .79 (20)	F1 .67 (17)	G .87 (22)	H .87 (22)
H1 .26 (6.6)	H2 .12 (3)	J .65 (16.5)	J1 .12 (3)	K 2.36 (60)	K1 1.61 (41)
K2 1.50 (38)	K3 2.24 (57)	K4 1.70 (43.3)	K5 2.10 (53.3)	M .79 (20)	N .08 (2)
N1 .43 (11)	P Ø .17 Ø (4.3)	P1 Ø .12 Ø (3.1)	U 0.81 (20.5)	V 0.29 (7.5)	

Inches (mm)

C
 Inline Valves
 Viking
 Lite
 Viking
 Extreme
 B3, B5, B6
 Series
 B7, B8
 Series
 Air-Saver
 Unit
 "N"
 Series



For inventory, lead times, and kit lookup, visit www.pdnplu.com

P2LBX 5/2 & 5/3 Single & Double Operators – Remote Air Pilot

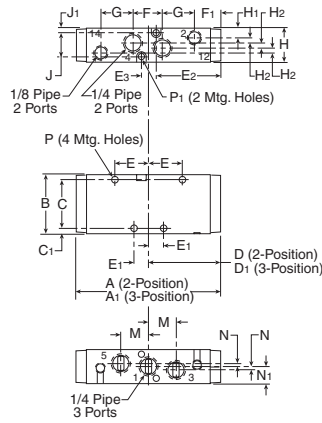

P2LBX 5/2 & 5/3 (remote air pilot)

A	A1	B	C	C1	D
3.95 (100)	4.61 (117)	1.57 (40)	1.26 (32)	.16 (4)	1.93 (49)
D1	E	E1	E2	E3	F
2.28 (58)	.91 (23)	.39 (10)	1.73 (44)	.39 (10)	.79 (20)
F1	G	H	H1	H2	J
.67 (17)	.87 (22)	.8 (22)	.26 (6.6)	.12 (3)	.65 (16.5)
J1	K	M	N	N1	P
.11 (2.8)	2.90 (74)	.79 (20)	.08 (2)	.43 (11)	Ø .17 Ø (4.3)
P1					
Ø .12 Ø (3.1)					

Inches (mm)

P2LBX 5/2 Single & Double Operators – Solenoid NAMUR

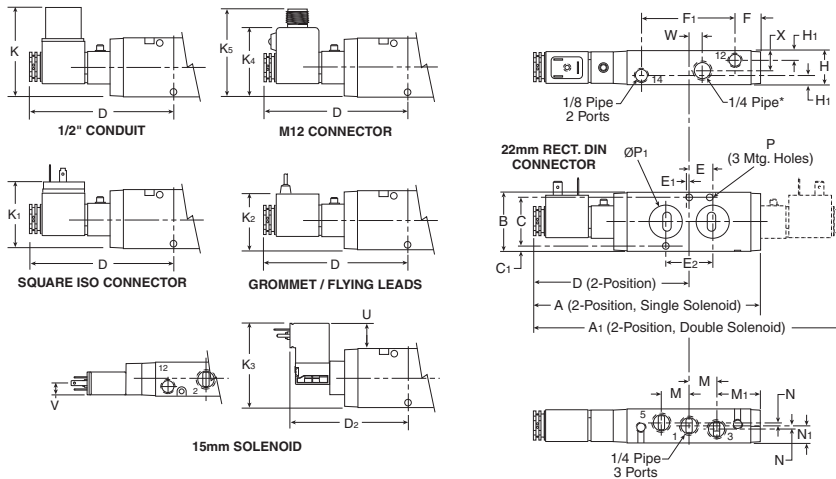

P2LBX 5/2 (NAMUR)

A	A1	B	C	C1	D
6.15 (156)	8.39 (213)	1.57 (40)	1.26 (32)	.16 (4)	4.21 (107)
D2	E	E1	E2	F	F1
3.48 (88.3)	.47 (12)	.08 (2)	.94 (24)	.67 (17)	2.52 (64)
K	K1	K2	K3	K4	K5
2.36 (60)	1.61 (41)	1.50 (38)	2.24 (57)	1.70 (43.3)	2.10 (53.3)
H	H1	M	M1	N	N1
.87 (22)	.26 (6.6)	.79 (20)	1.14 (29)	.08 (2)	.43 (11)
P	P1	U	V	W	X
Ø .22 Ø (5.5)	Ø .76 Ø (19.4)	0.81 (20.5)	0.29 (7.5)	0.39 (10)	0.50 (12.6)

Inches (mm)

* Valve includes 1/4 pipe plug, o-rings and mounting bolts.



P2LBX 3/2 Single & Double Operators – IEM Aluminum Bar Manifold

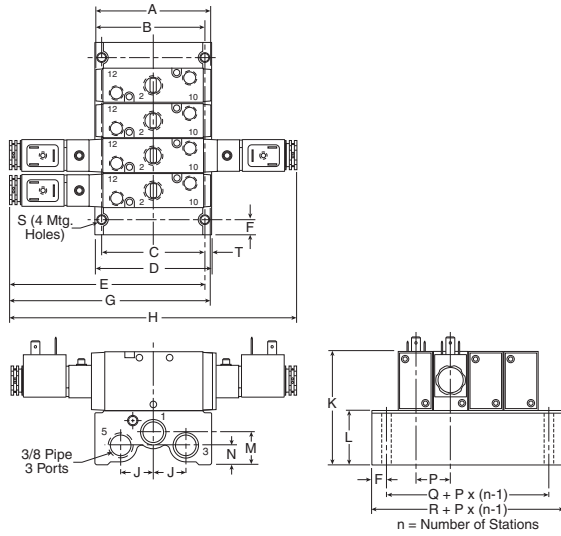

P2LBX 3/2
IEM Aluminum bar manifold

A	B	C	D	E
3.86 (78)	2.91 (74)	2.76 (70)	3.12 (79)	5.17 (131)

F	G	H	J	K
.40 (10.2)	5.33 (136)	7.6 (193)	.87 (22)	3.11 (79)

L	M	N	P	Q
1.47 (37)	.87 (22)	.52 (13.2)	.93 (23.5)	1.56 (39.6)

R	S	T
2.36 (60)	Ø .22 (5.5)	.18 (4.6)

Inches (mm)

P2LBX 5/2 & 5/3 Single & Double Operators – IEM Aluminum Bar Manifold

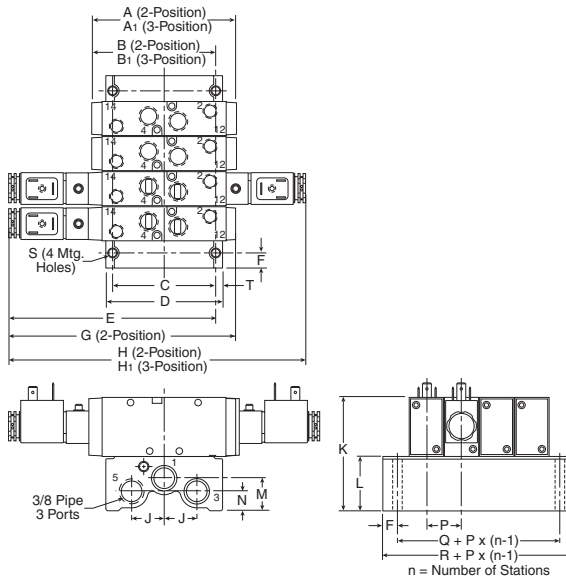

P2LBX 5/2 & 5/3
IEM Aluminum bar manifold

A	A ₁	B	B ₁	C
3.86 (98)	4.70 (120)	3.42 (84)	3.73 (95)	2.76 (70)

D	E	F	G	H
3.12 (79)	5.59 (142)	.40 (10.2)	6.14 (156)	8.39 (213)

H ₁	J	K	L	M
9.23 (235)	.87 (22)	3.11 (79)	1.47 (37)	.87 (22)

N	P	Q	R	S
.52 (13.2)	.93 (23.5)	1.56 (39.6)	2.36 (60)	Ø .22 (5.5)

T
.18 (4.6)

Inches (mm)

C
 Inline Valves
 Viking
 Lite
 Viking
 Extreme
 B3, B5, B6
 Series
 B7, B8
 Series
 Air-Saver
 Unit
 "N"
 Series



For inventory, lead times, and kit lookup, visit www.pdnplu.com

P2LCX 3/2 Single & Double Operators – Solenoid

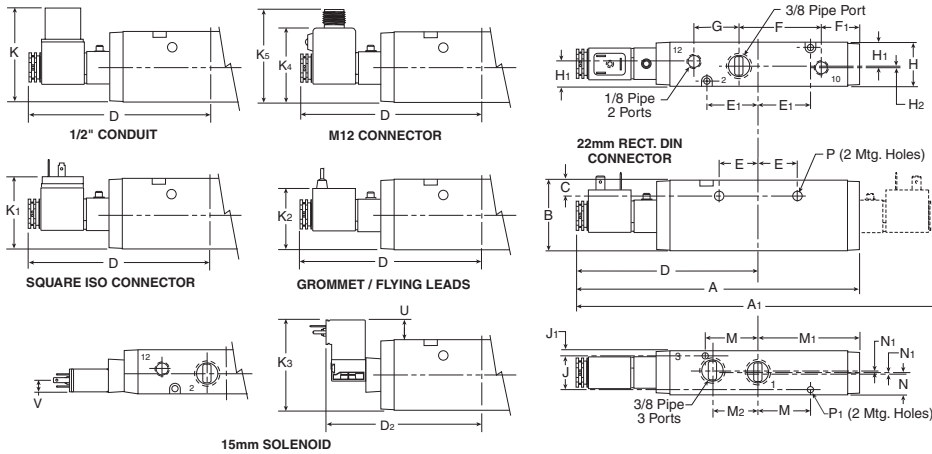

P2LCX 3/2 (solenoid)

A	A₁	B	C	D
7.66 (194.5)	9.80 (249)	1.89 (48)	.43 (11)	4.90 (124.5)
D₂	E	E₁	F	F₁
4.17 (105.8)	1.04 (26.5)	1.40 (35.5)	2.24 (57)	1.02 (26)
G	H	H₁	H₂	J
1.22 (31)	1.18 (30)	.67 (17)	.02 (0.5)	.91 (23)
J₁	K	K₁	K₂	K₃
.14 (3.5)	2.52 (64)	1.77 (45)	1.65 (42)	2.41 (61.3)
K₄	K₅	M	M₁	M₂
1.78 (45.3)	2.26 (57.3)	1.40 (35.5)	2.76 (70)	1.18 (30)
N	N₁	P	P₁	U
.55 (14)	.04 (1)	Ø .27 (6.9)	Ø .17 (4.4)	0.52 (13.3)
V	0.65 (7.5)			

Inches (mm)

P2LCX 3/2 Single & Double Operators – Remote Air Pilot

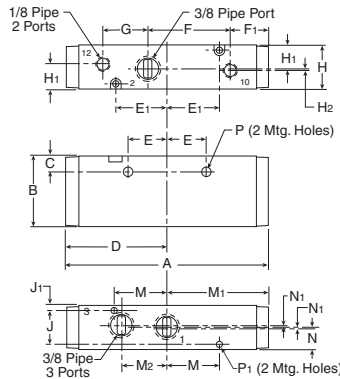

P2LCX 3/2 (remote air pilot)

A	B	C	D	E
5.51 (140)	1.89 (48)	.43 (11)	2.76 (70)	1.04 (26.5)
E₁	F	F₁	G	H
1.40 (35.5)	2.24 (57)	1.02 (26)	1.22 (31)	1.18 (30)
H₁	H₂	J	J₁	M
.67 (17)	.02 (0.5)	.91 (23)	.14 (3.5)	1.40 (35.5)
M₁	M₂	N	N₁	P
2.76 (70)	1.18 (30)	.55 (14)	.04 (1)	Ø .27 (6.9)
P₁	Ø .17 (4.4)			

Inches (mm)

C

Inline Valves

Viking Lite

Viking Extreme

B3, B5, B6 Series

B7, B8 Series

Air Saver Unit

"N" Series

P2LCX 5/2 & 5/3 Single & Double Operators – Solenoid

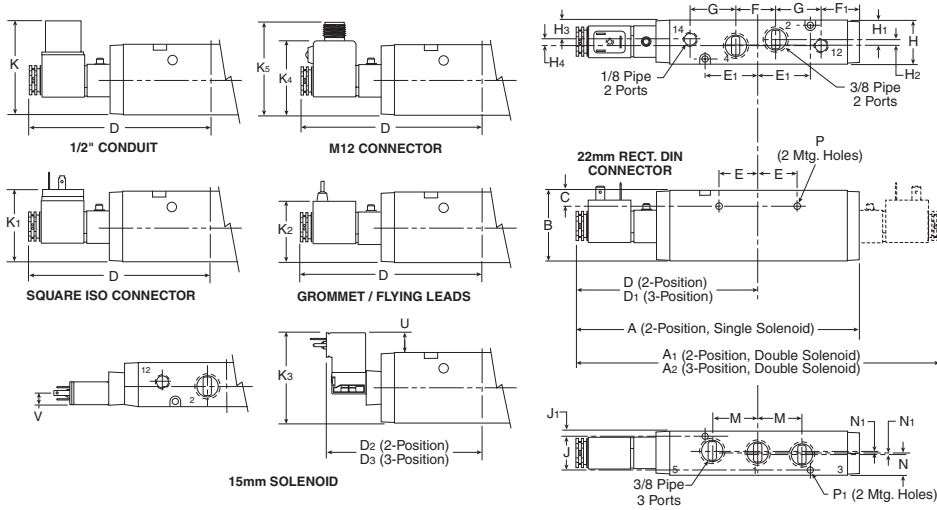

P2LCX 5/2 & 5/3 (solenoid)

A	A₁	A₂	B	C
7.68 (195)	9.84 (250)	10.71 (272)	1.89 (48)	.43 (11)
D	D₁	D₂	D₃	E
4.92 (125)	5.35 (136)	4.17 (105.8)	4.61 (117.2)	1.04 (26.5)
E₁	F	F₁	G	H
1.40 (35.5)	1.06 (27)	1.02 (26)	1.22 (31)	1.18 (30)
H₁	H₂	H₃	H₄	J
.53 (13.5)	.12 (3)	.51 (13)	.16 (4)	.91 (23)
J₁	K	K₁	K₂	K₃
.14 (3.5)	2.52 (64)	1.77 (45)	1.65 (42)	2.41 (61.3)
K₄	K₅	M	N	N₁
1.78 (45.3)	2.26 (57.3)	1.18 (30)	.55 (14)	.04 (1)
P	P₁	U	V	
Ø .27 (6.9)	Ø .17 (4.4)	0.52 (13.3)	0.29 (7.5)	

Inches (mm)

P2LCX 5/2 & 5/3 Single & Double Operators – Remote Air Pilot

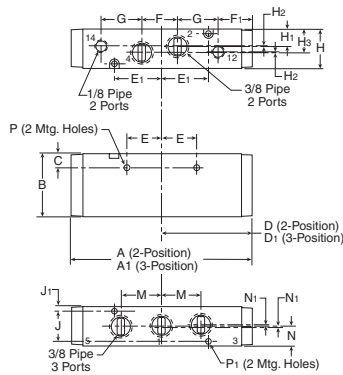

P2LCX 5/2 & 5/3 (remote air pilot)

A	A₁	B	C	D	D₁
5.51 (140)	6.38 (162)	1.89 (48)	.43 (11)	2.76 (70)	3.18 (81)
E	E₁	F	F₁	G	H
1.04 (26.5)	1.40 (35.5)	1.06 (27)	1.02 (26)	1.22 (31)	1.18 (30)
H₁	H₂	H₃	J	J₁	M
.51 (13)	.02 (0.5)	.12 (3)	.91 (23)	.14 (3.5)	1.18 (30)
N	N₁	P	P₁		
.55 (14)	.04 (1)	Ø .27 (6.9)	Ø .17 (4.4)		

Inches (mm)

P2LCX 3/2 Single & Double Operators – IEM Aluminum Bar Manifold

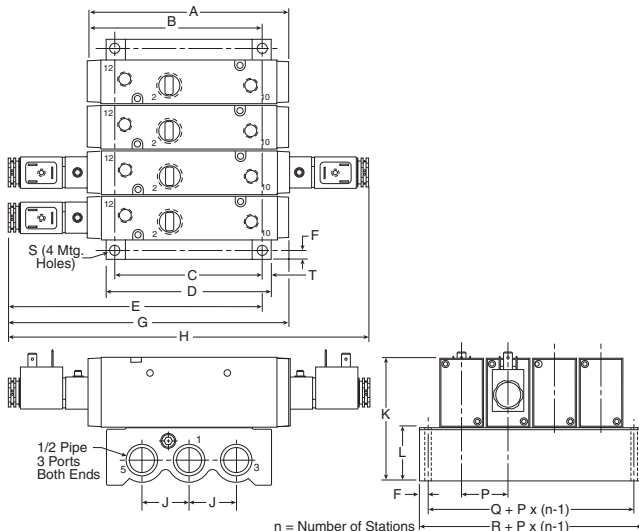

**P2LCX 3/2
 IEM Aluminum bar manifold**

A	B	C	D	E	F
5.51 (140)	4.96 (126)	3.94 (100)	4.41 (112)	7.11 (180.5)	.24 (6)
G	H	J	K	L	P
7.66 (194.5)	9.80 (249)	1.26 (32)	3.43 (87)	1.54 (39)	1.24 (31.5)
Q	R	S	T		
1.77 (45)	2.24 (57)	Ø .26 (6.5)	.24 (6)		

Inches (mm)

n = Number of Stations

P2LCX 5/2 & 5/3 Single & Double Operators – IEM Aluminum Bar Manifold

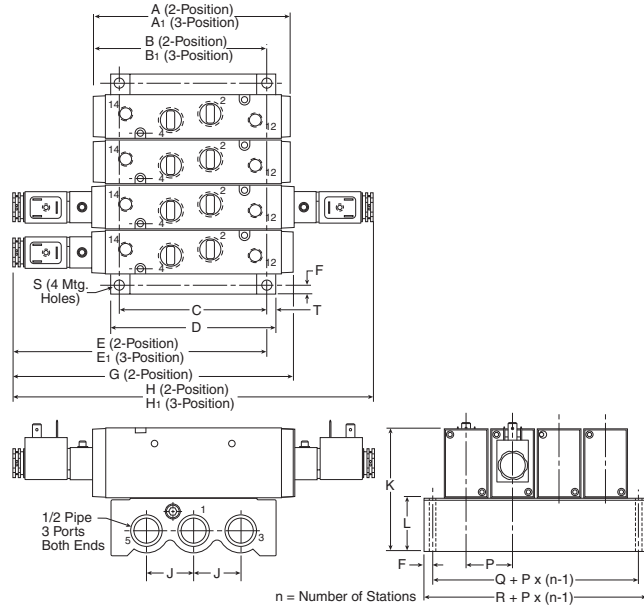

**P2PCX 5/2 & 5/3
 IEM Aluminum bar manifold**

A	A ₁	B	B ₁	C
5.51 (140)	6.38 (162)	4.72 (120)	5.16 (131)	3.94 (100)
D	E	E ₁	F	G
4.41 (112)	6.89 (170)	7.13 (181)	.24 (6)	7.68 (195)
H	H ₁	J	K	L
9.84 (250)	10.71 (272)	1.26 (32)	3.43 (87)	1.54 (39)
P	Q	R	S	T
1.24 (31.5)	1.77 (45)	2.24 (57)	∅ .26 (6.5)	.24 (6)

Inches (mm)

P2LDX 3/2 Single & Double Operators – Solenoid

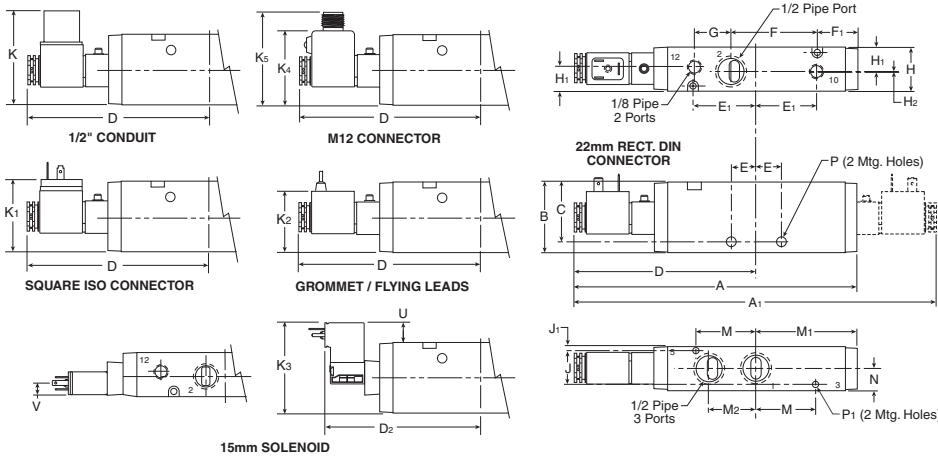

P2LDX 3/2 (solenoid)

A	A ₁	B	C	D
7.66 (194.5)	9.80 (249)	1.89 (48)	1.59 (40.5)	4.90 (124.5)
D ₂	E	E ₁	F	F ₁
4.17 (105.8)	.67 (17)	1.65 (42)	2.36 (60)	1.08 (27.5)
G	H	H ₁	H ₂	J
.98 (25)	1.18 (30)	.67 (17)	.02 (0.5)	.91 (23)
J ₁	K	K ₁	K ₂	K ₃
.14 (3.5)	2.52 (64)	1.77 (45)	1.65 (42)	2.41 (61.3)
K ₄	K ₅	M	M ₁	M ₂
1.78 (45.3)	2.26 (57.3)	1.65 (42)	2.76 (70)	1.30 (33)
N	P	P ₁	U	V
.59 (15)	∅ .26 (6.6)	∅ .17 (4.4)	0.65 (16.5)	0.29 (7.5)

Inches (mm)

C

Inline Valves

Viking
Lite

Viking
Extreme

B3, B5, B6
Series

B7, B8
Series

Air Saver
Unit

"N"
Series



For inventory, lead times, and kit lookup, visit www.pdnplu.com

C37

Parker Hannifin Corporation
 Pneumatic Division
 Richland, Michigan
www.parker.com/pneumatics

P2LDX 3/2 Single & Double Operators – Remote Air Pilot

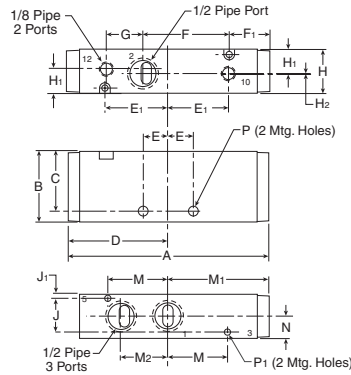

P2LDX 3/2 (remote air pilot)

A	B	C	D	E
5.51 (140)	1.89 (48)	1.59 (40.5)	2.76 (70)	.67 (17)
E1	F	F1	G	H
1.65 (42)	2.36 (60)	1.08 (27.5)	.98 (25)	1.18 (30)
H1	H2	J	J1	M
.67 (17)	.02 (0.5)	.91 (23)	.14 (3.5)	1.65 (42)
M1	M2	N	P	P1
2.76 (70)	1.30 (33)	.59 (15)	Ø .26 Ø (6.6)	Ø .17 Ø (4.4)

Inches (mm)

P2LDX 5/2 & 5/3 Single & Double Operators – Solenoid

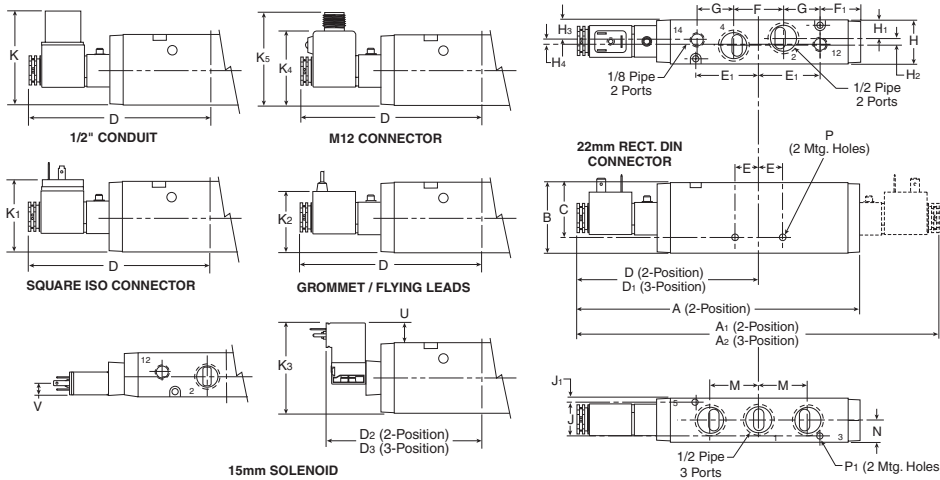

P2LDX 5/2 & 5/3 (solenoid)

A	A1	A2	B	C
7.67 (195)	9.84 (250)	10.7 (272)	1.89 (48)	1.59 (40.5)
D	D1	D2	D3	E
4.92 (125)	5.79 (147)	4.17 (105.3)	4.61 (117.2)	.67 (17)
E1	F	F1	G	H
1.65 (42)	1.34 (34)	1.10 (28)	.98 (25)	1.18 (30)
H1	H2	H3	H4	J
.49 (12.5)	.20 (5)	.51 (13)	.16 (4)	.91 (23)
J1	K	K1	K2	K3
.14 (3.5)	2.52 (64)	1.77 (45)	1.65 (42)	2.41 (61.3)
K4	K5	M	N	P
1.78 (45.3)	2.26 (57.3)	1.30 (33)	.59 (15)	Ø .26 Ø (6.6)
P1	U	V		
Ø .17 Ø (4.4)	0.52 (13.3)	0.29 (7.5)		

Inches (mm)

P2LDX 5/2 & 5/3 Single & Double Operators – Remote Pilot

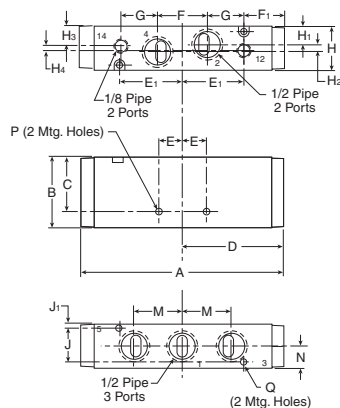

P2LDX 5/2 & 5/3 (remote)

A	B	C	D	E
5.47 (139)	1.89 (48)	1.59 (40.5)	2.63 (67)	.67 (17)
E1	F	F1	G	H
1.65 (42)	1.34 (34)	1.08 (27.5)	.98 (25)	1.18 (30)
H1	H2	H3	H4	J
.49 (12.5)	.20 (5)	.51 (13)	.16 (4)	.91 (23)
J1	P	M	N	Q
.14 (3.5)	Ø .26 Ø (6.6)	1.29 (32.7)	.59 (15)	Ø .17 Ø (4.4)

Inches (mm)

C
Inline Valves
Viking
Lite
Viking
Extreme
B3, B5, B6
Series
B7, B8
Series
Air-Saver
Unit
Series
"N"



For inventory, lead times, and kit lookup, visit www.pdnplu.com

Features

B3, B5 & B6 Series

B Series, an exceptional performing industrial valve in a compact size with an enhanced flow range.

Available in solenoid pilot operated and remote air pilot models. The B series features Parker's proven WCS (Wear Compensating Seal) system ensuring long life and fast response.

Ports

- B3: 1/8 NPT – 0.75 Cv
- B5: 1/4 & 3/8 NPT – 1.40 Cv
- B6: 3/8 NPT – 2.50 Cv

Mounting

- Inline
- IEM stackable base
- IEM aluminum bar

Solenoids

- 1.2 W – 15mm, 3-pin EN175301-803
- 24VDC, 120VAC
- Female DIN electrical connectors

Certification / Approval

- Approved to be CE marked
- IP65 rated



Operating information

Operating pressure:	Vacuum to 145 PSIG (Vacuum to 10 bar)
Minimum:	See chart below
CSA-NRTL/C:	See chart below
Operating temperature:	5°F to 120°F (-15°C to 49°C)

Material specifications

Body	Anodized aluminum
End caps	Nylon polymer - 33% glass filled
Seals	Nitrile
Solenoid	Polyamide
Spool	Aluminum

Minimum operating pressure

Operator / Function	Internal Pilot	Minimum PSIG (kPa)		
		B3	B5	B6
1, G, H	Single solenoid - air return			
2, A, J, S	Double solenoid	20 (138)	20 (138)	20 (138)
3*	Single remote pilot - air return			
4, M*	Double remote pilot	Vacuum	Vacuum	Vacuum
5, 6, 7	Double solenoid - APB, CE, PC	30 (207)	30 (207)	30 (207)
8, 9, 0*	Double remote pilot - APB, CE, PC	Vacuum	Vacuum	Vacuum
X, Y*	Single remote pilot - air return / spring assist*	35 (241)	35 (241)	35 (241)

* Remote Pilot Signal 35-145 PSIG (241-1000 kPa).

C

Inline Valves

Viking Lite

Viking Extreme

B3, B5, B6 Series

B7, B8 Series

Air Saver Unit

"N" Series



For inventory, lead times, and kit lookup, visit www.pdnplu.com

Common Part Numbers

Single Solenoid, 3-way, 2-position, NC



Symbol	Port Size	Cv	Voltage	Valve Type	Part Number
	1/8"	0.75 Cv	120VAC 24VDC	B3 Inline	B3G0BB553C B3G0BB549C
	1/4"	1.4 Cv	120VAC 24VDC	B5 Inline	B5G1BB553C B5G1BB549C
	3/8"	1.4 Cv	120VAC 24VDC	B5 Inline	B5G2BB553C B5G2BB549C

B3 shown, 3-Pin DIN 43650C electrical connection. Non-locking flush override.

Single Solenoid, 4-way, 2-position



Symbol	Port Size	Cv	Voltage	Valve Type	Part Number
	1/8"	0.75 Cv	120VAC 24VDC	B3 Inline	B310BB553C B310BB549C
	1/4"	1.4 Cv	120VAC 24VDC	B5 Inline	B511BB553C B511BB549C
	3/8"	1.4 Cv	120VAC 24VDC	B5 Inline	B512BB553C B512BB549C
	3/8"	2.7 Cv	120VAC 24VDC	B6 Inline	B612BB553A B612BB549A

B3 shown, 3-Pin DIN 43650C electrical connection. Non-locking flush override.

Double Solenoid, 4-way, 2-position



Symbol	Port Size	Cv	Voltage	Valve Type	Part Number
	1/8"	0.75 Cv	120VAC 24VDC	B3 Inline	B320BB553C B320BB549C
	1/4"	1.4 Cv	120VAC 24VDC	B5 Inline	B521BB553C B521BB549C
	3/8"	1.4 Cv	120VAC 24VDC	B5 Inline	B522BB553C B522BB549C
	3/8"	2.7 Cv	120VAC 24VDC	B6 Inline	B622BB553A B622BB549A

B5 shown, 3-Pin DIN 43650C electrical connection. Non-locking flush override.

ANSI / (NFPA) T3.21.3-1990 standard for Cv measurement.

15mm 3-Pin DIN 43650C, 8mm Pin Spacing

	Cord Length	Connector	Connector with Cord
Unlighted	18 Inches	PS2932BP	PS2932HBP
Unlighted	6 Feet	PS2932BP	PS2932JBP
Light - 12VAC or DC	6 Feet	PS294675BP	PS2946J75BP *
Light - 24VAC or DC	6 Feet	PS294679BP	PS2946J79BP *
Light - 110/120VAC	6 Feet	PS294683BP	PS2946J83BP *
Light - 240/230VAC		PS294687BP	N/A

* LED with surge suppression.

Note: Max ø6.5mm cable size required for connector w/o 6' (2m) cord. IP65 rated when properly installed.

Engineering data:

Conductors: 2 poles plus ground, polarity insensitive
Cable range (connector only): 4 to 6mm (0.16 To 0.24 Inch)
Contact spacing: 8mm

15mm 3-Pin DIN 43650C to 1/2" Conduit

Description	Connector
1/2" NPTF conduit - Unlighted with 3' (1m) leads 20 AWG wire	PS2998P

Note: Rated up to 250VAC or VDC; 6 amps IP65 rated when properly installed.

Most popular.



For inventory, lead times, and kit lookup, visit www.pdnplu.com

Common Part Numbers

Double Solenoid, 4-way, 3-position, APB

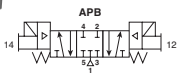
Symbol	Port Size	Cv	Voltage	Valve Type	Part Number
	1/8"	0.60 Cv	120VAC 24VDC	B3 Inline	B350BB553C B350BB549C
	1/4"	1.1 Cv	120VAC 24VDC	B5 Inline	B551BB553C B551BB549C
	3/8"	1.1 Cv	120VAC 24VDC	B5 Inline	B552BB553C B552BB549C
	3/8"	2.1 Cv	120VAC 24VDC	B6 Inline	B652BB553A B652BB549A

B5 shown, 3-Pin DIN 43650C electrical connection. Non-locking flush override.

Double Solenoid, 4-way, 3-position, CE

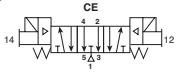
Symbol	Port Size	Cv	Voltage	Valve Type	Part Number
	1/8"	0.60 Cv	120VAC 24VDC	B3 Inline	B360BB553C B360BB549C
	1/4"	1.1 Cv	120VAC 24VDC	B5 Inline	B561BB553C B561BB549C
	3/8"	1.1 Cv	120VAC 24VDC	B5 Inline	B562BB553C B562BB549C
	3/8"	2.1 Cv	120VAC 24VDC	B6 Inline	B662BB553A B662BB549A

B5 shown, 3-Pin DIN 43650C electrical connection. Non-locking flush override.

Double Solenoid, 4-way, 3-position, PC

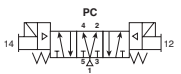
Symbol	Port Size	Cv	Voltage	Valve Type	Part Number
	1/8"	0.60 Cv	120VAC 24VDC	B3 Inline	B370BB553C B370BB549C
	1/4"	1.1 Cv	120VAC 24VDC	B5 Inline	B571BB553C B571BB549C
	3/8"	1.1 Cv	120VAC 24VDC	B5 Inline	B572BB553C B572BB549C
	3/8"	2.1 Cv	120VAC 24VDC	B6 Inline	B672BB553A B672BB549A

B5 shown, 3-Pin DIN 43650C electrical connection. Non-locking flush override.

ANSI / (NFPA) T3.21.3-1990 standard for Cv measurement.

15mm 3-Pin DIN 43650C, 8mm Pin Spacing

	Cord Length	Connector	Connector with Cord
Unlighted	18 Inches	PS2932BP	PS2932HBP
Unlighted	6 Feet	PS2932BP	PS2932JBP
Light – 12VAC or DC	6 Feet	PS294675BP	PS2946J75BP *
Light – 24VAC or DC	6 Feet	PS294679BP	PS2946J79BP *
Light – 110/120VAC	6 Feet	PS294683BP	PS2946J83BP *
Light – 240/230VAC		PS294687BP	N/A

* LED with surge suppression.

Note: Max ø6.5mm cable size required for connector w/o 6' (2m) cord. IP65 rated when properly installed.

Engineering data:

- Conductors: 2 poles plus ground, polarity insensitive
- Cable range (connector only): 4 to 6mm (0.16 To 0.24 Inch)
- Contact spacing: 8mm

Most popular.

15mm 3-Pin DIN 43650C to 1/2" Conduit

Description	Connector
1/2" NPTF conduit – Unlighted with 3' (1m) leads 20 AWG wire	PS2998P

Note: Rated up to 250VAC or VDC; 6 amps IP65 rated when properly installed.



For inventory, lead times, and kit lookup, visit www.pdnplu.com

Common Part Numbers

Single Remote Pilot, 3-way, 2-position, NC



Symbol

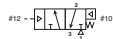

B3 Shown, M5 Remote Pilot Ports

Port Size	Cv	Valve Type	Part Number
1/8"	0.75 Cv	B3 Inline, remote pilot	B3X0000XXC
1/4"	2.7 Cv	B5 Inline, remote pilot	B5X1000XXC
3/8"	1.4 Cv	B5 Inline, remote pilot	B5X2000XXC

Single Remote Pilot, 4-way, 2-position



Symbol



B5 Shown, M5 Remote Pilot Ports

Port Size	Cv	Valve Type	Part Number
1/8"	0.75 Cv	B3 Inline, remote pilot	B330000XXC
1/4"	1.4 Cv	B5 Inline, remote pilot	B531000XXC
3/8"	1.4 Cv	B5 Inline, remote pilot	B532000XXC
3/8"	2.7 Cv	B6 Inline, remote pilot	B632000XXA

Double Remote Pilot, 4-way, 2-position



Symbol



B5 Shown, M5 Remote Pilot Ports

Port Size	Cv	Valve Type	Part Number
1/8"	0.75 Cv	B3 Inline, remote pilot	B340000XXC
1/4"	1.4 Cv	B5 Inline, remote pilot	B541000XXC
3/8"	1.4 Cv	B5 Inline, remote pilot	B542000XXC
3/8"	2.7 Cv	B6 Inline, remote pilot	B642000XXA

Double Remote Pilot, 4-way, 3-position, APB



Symbol

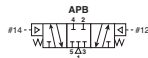

B5 Shown, M5 Remote Pilot Ports

Port Size	Cv	Valve Type	Part Number
1/8"	0.60 Cv	B3 Inline, remote pilot	B380000XXC
1/4"	1.1 Cv	B5 Inline, remote pilot	B581000XXC
3/8"	1.1 Cv	B5 Inline, remote pilot	B582000XXC
3/8"	2.1 Cv	B6 Inline, remote pilot	B682000XXA

ANSI / (NFPA) T3.21.3-1990 standard for Cv measurement.

Most popular.



For inventory, lead times, and kit lookup, visit www.pdnplu.com

C
 Inline Valves
 Viking Lite
 Viking Extreme
 B3, B5, B6 Series
 B7, B8 Series
 Air-Saver Unit
 "N" Series

B3 Series

B3 1 0 B B 5 49 - C

Basic Series	
B3 Series	B3

Engineering Level	
C	Current

Operator Function	
3-way	
Single Solenoid, 2-Position Nc - Air Return	G
Single Solenoid, 2-Position No - Air Return	H
Double Solenoid, 2-Position	J
Double Remote Pilot, 2-Position	M
Single Remote Pilot, 2-Position Nc - Air Return / Spring Assist	X
Single Remote Pilot, 2-Position No - Air Return / Spring Assist	Y
4-Way	
Single Solenoid, 2-Position - Air Return	1
Double Solenoid, 2-Position	2
Single Remote Pilot, 2-Position - Air Return	3
Double Remote Pilot, 2-Position	4
Double Solenoid, 3-Position - APB	5
Double Solenoid, 3-Position - CE	6
Double Solenoid, 3-Position - PC	7
Double Remote Pilot, 3-Position - APB	8
Double Remote Pilot, 3-Position - CE	9
Double Remote Pilot, 3-Position - PC	0

Options	
Blank	None

Voltage			
	AC		DC
	60Hz	50Hz	
49			24
53	120	110	
XX	Remote Pilot - M5 or Valve Less 15mm Solenoid		

Enclosure / Lead Length	
0	None, Remote Pilot Valve
5	15mm 3-Pin Din 43650c (Male Only)

Port Size / Thread Type	
3-way, 4-way *	
1/8" NPT Inline	0

* Available for use on IEM Manifolds.

Overrides	
0	Remote Pilot Valve
B	Flush - Non-Locking
C	Flush - Locking
X	Valve Less 15mm Solenoid

Pilot Source / Pilot Exhaust	
0	Remote Pilot Valve
B†	Internal - Port #1 / Vented

† Not available for Remote Pilot Valves.

C
Inline Valves
Viking Lite
Viking Extreme
B3, B5, B6 Series
B7, B8 Series
Air Saver Unit
"N" Series

 Most popular.



For inventory, lead times, and kit lookup, visit www.pdnplu.com

B5 Series

C	Inline Valves
	Viking Lite
	Viking Extreme
	B3, B5, B6 Series
	B7, B8 Series
	Air-Saver Unit
	"N" Series

B5 1 1 B B 5 49 - C

Basic Series	
B5 Series	B5

Engineering Level	
C	Current

Operator Function	
3-Way	
Single Solenoid, 2-Position Nc - Air Return	G
Single Solenoid, 2-Position No - Air Return	H
Double Solenoid, 2-Position	J
Double Remote Pilot, 2-Position	M*
Single Remote Pilot, 2-Position Nc - Air Return / Spring Assist	X*
Single Remote Pilot, 2-Position No - Air Return / Spring Assist	Y*
4-Way	
Single Solenoid, 2-Position - Air Return	1
Double Solenoid, 2-Position	2
Single Remote Pilot, 2-Position - Air Return	3*
Double Remote Pilot, 2-Position	4*
Double Solenoid, 3-Position - APB	5
Double Solenoid, 3-Position - CE	6
Double Solenoid, 3-Position - PC	7
Double Remote Pilot, 3-Position - APB	8*
Double Remote Pilot, 3-Position - CE	9*
Double Remote Pilot, 3-Position - PC	0*

Options	
Blank	None

Voltage			
	AC		DC
	60Hz	50Hz	
49			24
53	120	110	
XX	Remote Pilot - M5 or Valve Less Solenoid		

Enclosure / Lead Length	
0	Remote Pilot Valve
5	15mm 3-Pin DIN 43650C (male only)
X	Valve Less 15mm Solenoid

Overrides	
0	Remote Pilot Valve
B *	Flush - Non-Locking
C *	Flush - Locking

* Pilot source/pilot exhaust, override, and enclosure must be "0".

Port Size / Thread Type	
3-way, 4-way *	
1/4" NPT Inline	1
3/8" NPT Inline	2

* 4-way available for use on IEM manifolds

Pilot Source / Pilot Exhaust	
Remote Pilot Valve	0
Internal - Port #1 / Vented	B †

† Not available for remote pilot valves.

* Only available with encl. "5".

Most popular.



For inventory, lead times, and kit lookup, visit www.pdnplu.com

B6 Series

B6 1 2 B B 5 49 - A

Basic Series	
B6 Series	B6

Engineering Level	
C	Current

Operator function	
4-way	
Single Solenoid, 2-Position - Air Return	1
Double Solenoid, 2-Position	2
Single Remote Pilot, 2-Position - Air Return	3
Double Remote Pilot, 2-Position	4
Double Solenoid, 3-Position - APB	5
Double Solenoid, 3-Position - CE	6
Double Solenoid, 3-Position - PC	7
Double Remote Pilot, 3-Position - APB	8
Double Remote Pilot, 3-Position - CE	9
Double Remote Pilot, 3-Position - PC	0

Options	
Blank	None

Voltage			
	AC		DC
	60Hz	50Hz	
49			24
53	120	110	
XX	Remote Pilot - M5 or Valve Less 15mm Solenoid		

Port Size / Thread Type	
4-way	
3/8" NPT Inline	2*

* Available for use on IEM manifolds.

Enclosure / Lead Length	
0	Remote Pilot Valve
5	15mm 3-Pin DIN 43650C (male only)
X	Valve Less 15mm Solenoid

Pilot Source / Pilot Exhaust	
None. Remote Pilot Valve	0
Internal - Port #1 / Vented	B†

† Not available for remote pilot valves.

Overrides [§]	
Remote Pilot Valve	0
Flush - Non-Locking	B *
Flush - Locking	C *
Valve Less 15mm Solenoid	X

* Available for use on IEM manifolds.

 Most popular.



For inventory, lead times, and kit lookup, visit www.pdnplu.com

C
Inline Valves
Viking Lite
Viking Extreme
B3, B5, B6 Series
B7, B8 Series
Air Saver Unit
"N" Series

Accessories

B3 B5 B6 IEM Manifold, Inline Valves Only



Valve Series	Valve Function	## – Stations	Manifold Kit Only (NPT)
B3	4-way	2	PSM3BXN02NP
		4	PSM3BXN04NP
		6	PSM3BXN06NP
		8	PSM3BXN08NP
B5	4-way	2	PSM5BXN02NP
		4	PSM5BXN04NP
		6	PSM5BXN06NP
		8	PSM5BXN08NP
B6	4-way	2	PSM6BXN02NP
		4	PSM6BXN04NP
		6	PSM6BXN06NP
		8	PSM6BXN08NP

Kits include: (1) manifold, valve hold down bolts, O-rings.

C

Inline Valves

Viking Lite

Viking Extreme

B3, B5, B6 Series

B7, B8 Series

Air-Saver Unit

"N" Series

Most popular.



For inventory, lead times, and kit lookup, visit www.pdnplu.com

Accessories

IEM Stackable Manifolds

- Individual Manifold Bases stack together to form lightweight custom length manifold system.
- Easy-to-connect male / female tie rods for modular assembly.
- Utilizes B3 and B5 4-way Inline Valves.
- Low-cost built-in Flow Controls with heavy-duty brass adjusting needles to control meter-out exhaust flow.
- Accessories include Isolator Plugs for pressure isolation and Universal Blanking Plates for auxiliary inlet and exhaust supply and future valve additions.

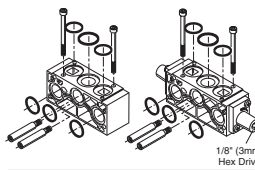
	Series	Type	Kit Number	
			Standard	Flow Control
	B3	4-way	PS2917P	PS2918P
	B5	4-way	PS2817P	PS2818P

Kit includes: (1) manifold base, (2) hold-down bolts, tie-rods, gaskets and o-rings.

Isolator Plugs

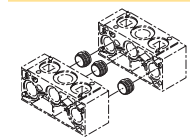
	Series	Description	Kit Number
	B3	4-way, IEM stackable	PS2919P
	B5	4-way, IEM stackable	PS2819P

Used to isolate the #1, #3 or #5 gallery between two manifold bases. (IEM stackable only)

Kit includes: (3) plugs and (6) o-rings

End Plate Kits

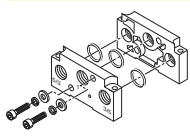
	Series	Type	Port Type	Kit Number
	B3	4-way, NPT	1/4	PS2915P
	B5	4-way, NPT	3/8	PS2815P

Kit includes: right and left end plate, o-rings, socket head cap screws, flat washers and lockwashers.

Blanking Plate

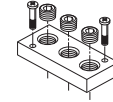

		IEM Universal	IEM
		NPT	Blank
B3	4-way	PS2920P	PS2969P
B5	4-way	PS2820P	PS2869P
B6	4-way	PS2620P	—

Kit includes: (1) plate, (2) screws, seal / gaskets

 Most popular.



For inventory, lead times, and kit lookup, visit www.pdnplu.com

Solenoid Kits – B3 ‘C’, B5 ‘C’, B6 ‘A’, 3-Pin, EN175301-803 (Former DIN 43650C), 15mm

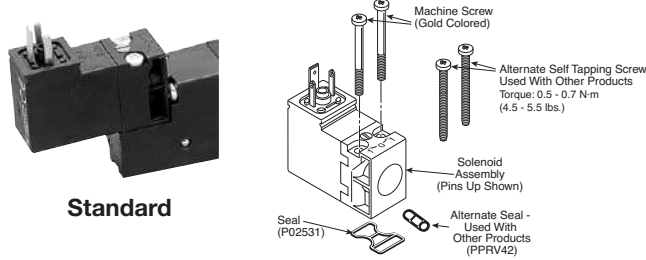

PS2982*##P – Enclosure ‘5’

	## Voltage	
Override *	49	53
B	S	S
C	S	S

S - Standard;

Kit includes: Solenoid, (2) machine screws, (2) self threading screws, (1) gasket, (1) 3-cell gasket.

15mm 3-Pin DIN 43650C, 8mm Pin Spacing

	Cord Length	Connector	Connector with Cord
Unlighted	18 Inches	PS2932BP	PS2932HBP
Unlighted	6 Feet	PS2932BP	PS2932JBP
Light – 12VAC or DC	6 Feet	PS294675BP	PS2946J75BP *
Light – 24VAC or DC	6 Feet	PS294679BP	PS2946J79BP *
Light – 110/120VAC	6 Feet	PS294683BP	PS2946J83BP *
Light – 240/230VAC		PS294687BP	N/A

* LED with surge suppression.

Note: Max ø6.5mm cable size required for connector w/o 6' (2m) cord.
 IP65 rated when properly installed.

Engineering data:

- Conductors: 2 poles plus ground, polarity insensitive
- Cable range (connector only): 4 to 6mm (0.16 To 0.24 Inch)
- Contact spacing: 8mm

15mm 3-Pin DIN 43650C to 1/2" Conduit

Description	Connector
1/2" NPTF conduit – Unlighted with 3' (1m) leads 20 AWG wire	PS2998P

Note: Rated up to 250VAC or VDC; 6 amps
 IP65 rated when properly installed.

Most popular.



For inventory, lead times, and kit lookup, visit www.pdnplu.com

Solenoid Information (Solenoids are rated for continuous duty.)

Voltage				Enclosure "5"	
Code	AC		DC	Power Consumption	Holding (Amps)
	60Hz	50Hz			
49			24	1.2W	.049
53	120	110		1.6W	.013

Response Time (Sec)

Valve Size	Port Size	Enclosure "5"			
		0 Cu. In. Test Chamber		25 * Cu. In. Test Chamber	
		Fill	Exhaust	Fill	Exhaust
2-Position Single Solenoid / Internal Air Return					
B3	1/8"	.024	.026	.149	.242
B5	1/4"	.038	.040	.106	.156
B5 *	3/8"	.039	.041	.150	.245
B6 *	3/8"	.037	.038	.096	.132
2-Position Double Solenoid					
B3	1/8"	.013	.015	.122	.213
B5	1/4"	.016	.018	.082	.132
B5 *	3/8"	.016	.018	.129	.222
B6 *	3/8"	.016	.017	.074	.110
3-Position Double Solenoid					
B3	1/8"	.021	.023	.091	.141
B5	1/4"	.022	.023	.091	.141
B5 *	3/8"	.022	.024	.135	.229
B6 *	3/8"	.024	.026	.094	.139

Average Fill Time (Seconds): With 100 PSIG supply, time required to fill from 0-90 PSIG and exhaust from 100 PSIG to 10 PSIG is measured from instant of energizing, or de-energizing 120V/60Hz solenoid. Times shown are average.

* For 3/8" ported, 50 cu. in. test chamber is used. For 1/2" & 3/4", a 200 cu. in. test chamber is used.

 Most popular.



For inventory, lead times, and kit lookup, visit www.pdnplu.com

B3C Series

Spool / Body Service Kits

Kit Includes:

PS2901CP	4-Way, 2-Pos	Item 15, 21 (2), 24, 25, 31 (2), grease packet
PS2902CP	4-Way, 3-Pos APB	Item 16, 21 (2), 31 (2), grease packet
PS2903CP	4-Way, 3-Pos CE	Item 16, 21 (2), 31 (2), grease packet
PS2904CP	4-Way, 3-Pos PC	Item 16, 21 (2), 31 (2), grease packet
PS2971CP	3-Way, 2-Pos	Item 15, 21 (2), 24, 25, 31 (2), grease packet

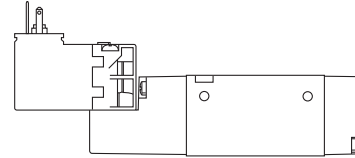

Valve to Manifold Kits

PS2980P	Gasket (10) - Inline 3-Way Valve to Segmented Manifold
PS2981P	Gasket (10) - Inline 4-Way Valve to Segmented Manifold
PS2984P	O-ring (10) - Inline Valve to IEM Bar Manifold
PS2987P	Mounting Bolts (10) - Inline Valve / Subbase Valve

Manifold to Manifold Kit

PS2996P	Gasket (10), Tie Rods (10) - 4-Way Manifold
---------	---

Solenoid Kit Kit Includes: 35, 36, 34

PS2982*##P	3-Pin, EN175301-803, 15mm
------------	---------------------------

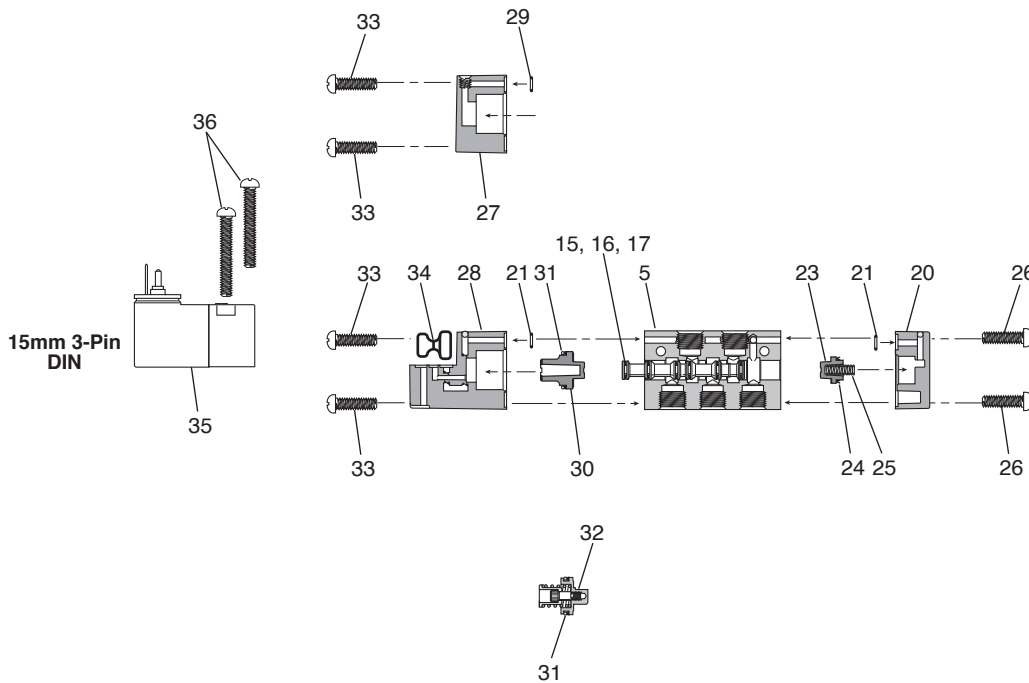

Item List – Parts not sold separately.

Item	Description	Item	Description	Item	Description
5	Inline Body - Tapped Ports	25*	Spring, Return Assist	33	Screws - Operator Adapter
15*	Spool - 2-Position (Seals Assembled)	26	Screws - Return Operator	34*	Gasket - Solenoid to Adapter
16*	Spool - 3-Position (Seals Assembled)	27	Remote Pilot Operator	35*	15mm Solenoid
17*	Spool Seal	28a	Solenoid Adapter - Vent Exhaust	36*	Self Tapping Screw - Solenoid (Effective May 99)
20	Return Operator	29	O-ring - Remote Pilot	36*	Machine Screw - Solenoid (Jan 96 - May 99)
21*	Gasket - Body to Operator	30	Operator Piston - 2-Position		
23	Return Piston	31*	Lip Seal - Operator Piston		
24*	Lip Seal - Return Piston	32	Operator Piston Mechanism - 3-Position		

Note: * Parts are available in kits shown.

C
 Inline Valves
 Viking Lite
 Viking Extreme
 B3, B5, B6 Series
 B7, B8 Series
 Air Saver Unit
 "N" Series



For inventory, lead times, and kit lookup, visit www.pdnplu.com

B5C Series

Spool / Body Service Kits

PS2801*P	4-Way, 2-Pos	<i>Kit Includes:</i>
PS2802*P	4-Way, 3-Pos APB	Item 2, 10 (2), 14, 15, 116, 6 (2), grease packet
PS2803*P	4-Way, 3-Pos CE	Item 3, 6 (2), 10 (2), 13 (2), grease packet
PS2804*P	4-Way, 3-Pos PC	Item 3, 6 (2), 10 (2), 13 (2), grease packet
PS2871*P	3-Way, 2-Pos NC	Item 2, 10 (2), 14, 15, 116, 6 (2), grease packet

* Fluorocarbon Seal Kit (i.e. PS2801VP)

Valve to Manifold Kits

PS2884P	O-ring (10) - Inline Valve to IEM Manifold (All)
PS2887P	Mounting Bolts (10) - Inline & Subbase Valve

Manifold to Manifold Kit

PS2896P	Gasket (10), Tie Rods (10) - 4-Way Manifold
---------	---

Solenoid Kit *Kit Includes: 25, 122, 123*

PS2982*##P	3-Pin, EN175301-803, 15mm
------------	---------------------------

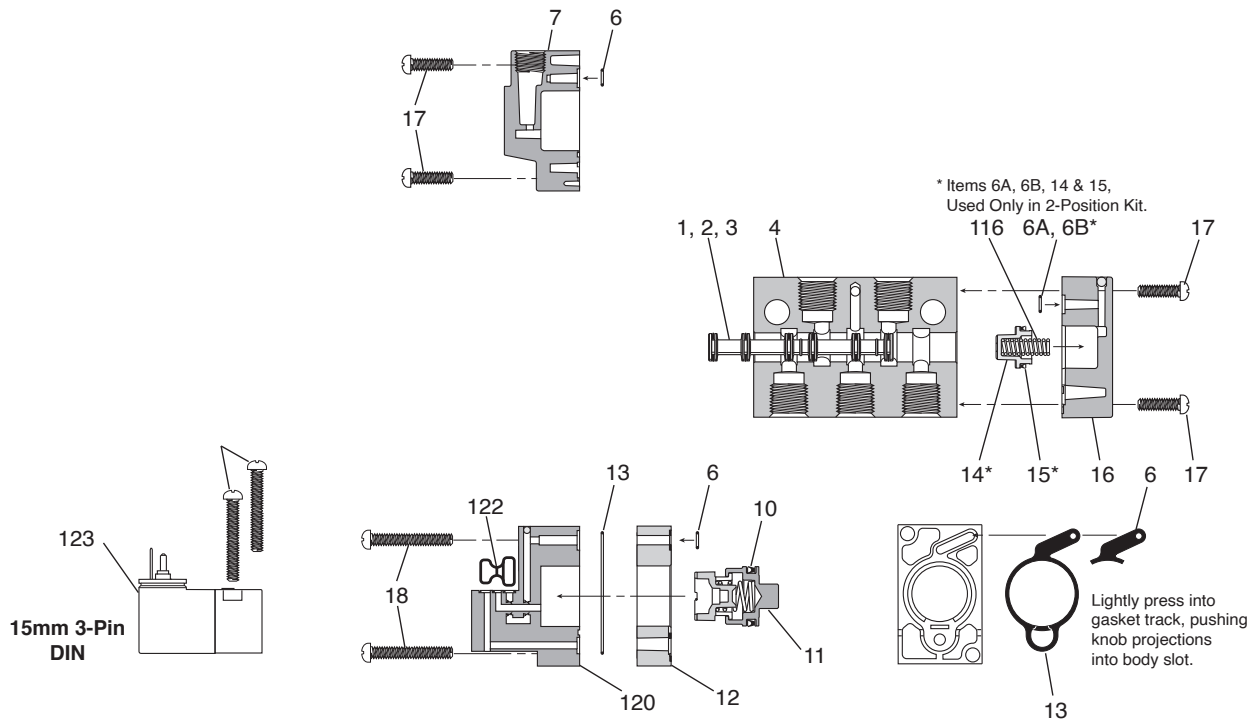

Item List – Parts not sold separately.

Item	Description	Item	Description	Item	Description
1*	Spool Seal	10*	Lip Seal - Operator Piston	18*	Screws - Operator Adapter - 3-Position
2*	Spool - 2-Position (Seals Assembled)	11	Operator Piston Mechanism - 3-Position	25a*	Self Tapping Screw - Solenoid (Effective May 99)
3*	Spool - 3-Position (Seals Assembled)	12	Adapter - 3-Position	25b*	Machine Screw - Solenoid (Jan 96 - May 99)
4	Inline Body	13*	Gasket - 3-Position Adapter to Body	116*	Spring, Return Assist
6A*	Gasket - Body to Operator	14	Return Piston	120a	Solenoid Adapter - Vent Exhaust
6B	O-ring - Body to Operator (Effective July 2007)	15*	Lip Seal - Return Piston	122*	Gasket - Solenoid to Adapter
7	Remote Pilot Operator	16	Return Operator	123*	15mm Solenoid
		17*	Screws - Operator Adapter - 2-Position		

Note: * Parts are available in kits shown.

C
Inline Valves
Viking Lite
Viking Extreme
B3, B5, B6 Series
B7, B8 Series
Air Saver Unit
"N" Series

B6A Series

Spool / Body Service Kits

		<i>Kit Includes:</i>
PS2601P	4-Way, 2-Pos	Item 2, 6 (2), 9 (2), 11, 14, grease packet
PS2602P	4-Way, 3-Pos APB	Item 3, 6 (2), 9 (2), 13 (2), grease packet
PS2603P	4-Way, 3-Pos CE	Item 3, 6 (2), 9 (2), 13 (2), grease packet
PS2604P	4-Way, 3-Pos PC	Item 3, 6 (2), 9 (2), 13 (2), grease packet

Solenoid Kit *Kit Includes: 25, 122, 123*

PS2982***P 3-Pin, EN175301-803, 15mm

Valve to Manifold Kits

PS2684P	O-ring (10) - Inline Valve to IEM Manifold
PS2887P	Mounting Bolts (10) - Inline Valve

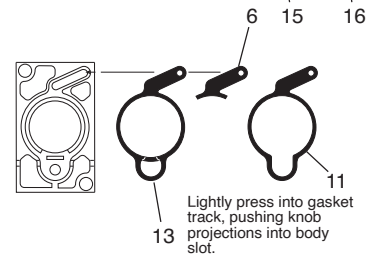
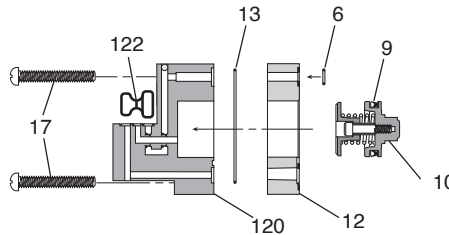
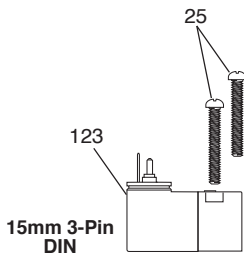
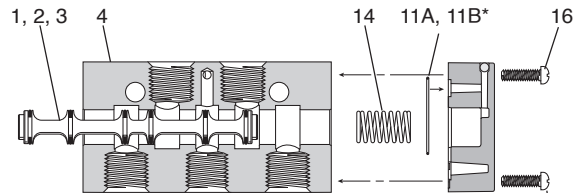
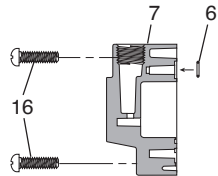

* Item 11A & 11B used in 2-Position Kit Only

Item List – Parts not sold separately.

Item	Description	Item	Description	Item	Description
1*	Spool Seal	10	Operator Piston Mechanism - 3-Position	15a	Return Operator
2*	Spool - 2-Position (Seals Assembled)	11A*	Gasket - Body to Return Cap	16*	Screws - Operator Adapter - 2-Position
3*	Spool - 3-Position (Seals Assembled)	11B*	O-ring - Body to Operator (Effective Feb. 2008)	17*	Screws - Operator Adapter - 3-Position
4	Inline Body - 4-Way	12	Adapter - 3-Position	120a	Solenoid Adapter - Vent Exhaust
6*	Gasket - Body to Operator	13	Gasket - 3-Position Adapter to Body	122*	Gasket - Solenoid to Adapter
7	Remote Pilot Operator	14*	Spring, Return Assist	123*	15mm Solenoid
9*	Lip Seal - Operator Piston				

Note: * Parts are available in kits shown. For kit components, order VALVE LESS SOLENOID for assembled and tested repair valve.

C
 Inline Valves
 Viking Lite
 Viking Extreme
 B3, B5, B6 Series
 B7, B8 Series
 Air-Saver Unit
 "N" Series



For inventory, lead times, and kit lookup, visit www.pdnplu.com

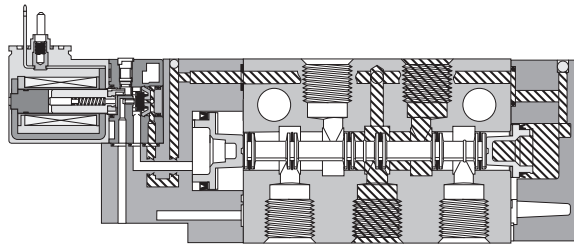

B5 Single Solenoid Inline - Air Return
 Shown De-Energized

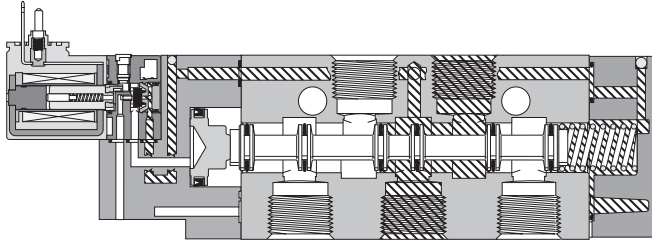

B6 Single Solenoid Inline - Spring / Air Return
 Shown De-Energized

 Pressure  Exhaust

**Single Solenoid
 3-Way, 2-Position
 NC (NNP)**

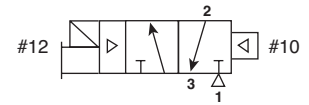

Normally Closed:

De-energized position – Solenoid #12 de-energized. Pressure at inlet port 1 blocked, outlet port 2 connected to exhaust port 3.

Energized position – Solenoid #12 energized. Pressure at inlet port 1 connected to outlet port 2, exhaust port 3 is blocked.

**Single Solenoid
 3-Way, 2-Position
 NO (NP)**

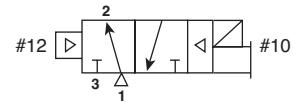

Normally Open:

De-energized position – Solenoid #10 de-energized. Pressure at inlet port 1 connected to outlet port 2, exhaust port 3 is blocked.

Energized position – Solenoid #10 energized. Pressure at inlet port 1 blocked, outlet port 2 connected to exhaust port 3.

3-Way Configuration

B3, B5:

Looking at the #1 and #3 ports, the solenoid (or remote operator) is on the #3 port end for NC and the #1 port end for NO. The same spool is used for both.

C

Inline Valves

Viking Lite

Viking Extreme

B3, B5, B6 Series

B7, B8 Series

Air Saver Unit

"N" Series



B3 Single & Double Operators – 4-way Inline

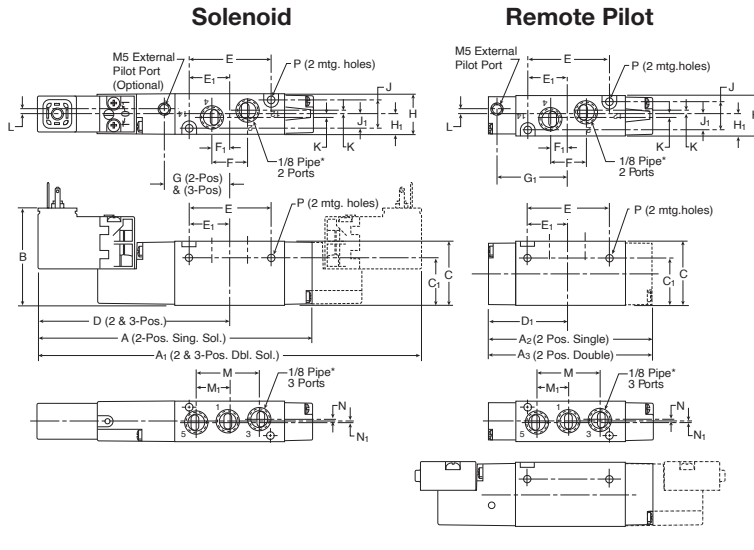

B3 4-Way Inline

A 4.67 (119)	A1 6.44 (164)	A2 3.12 (79)	A3 3.33 (85)	B 1.66 (42)
C 1.13 (39)	C1 .84 (21)	D 3.22 (82)	D1 1.66 (42)	E 1.47 (37)
E1 .74 (19)	F .63 (16)	F1 .32 (8)	G 1.13 (29)	G1 1.50 (38)
H .71 (18)	H1 .36 (9)	J .51 (13)	J1 .26 (7)	K .06 (2)
L .11 (3)	M 1.12 (28)	M1 .56 (14)	N .05 (1)	N1 .05 (1)
P Ø .13 Ø (3.3)				
Inches (mm)				

B3 Single & Double Operators – 3-way Inline

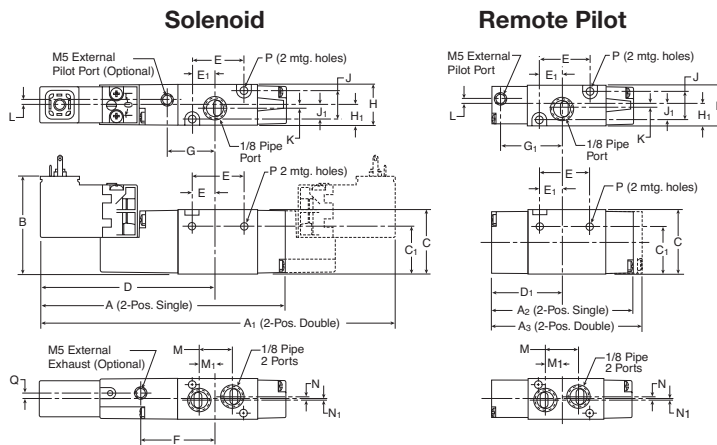

B3 3-Way Inline

A 4.20 (107)	A1 5.96 (151)	A2 2.65 (67)	A3 2.86 (73)	B 1.66 (42)
C 1.13 (39)	C1 .84 (21)	D 2.93 (74)	D1 1.38 (35)	E .98 (25)
E1 .44 (11)	F 1.32 (34)	G .85 (22)	G1 1.22 (31)	H .71 (18)
H1 .36 (9)	J .51 (13)	J1 .26 (7)	K .06 (2)	L .11 (3)
M .63 (16)	M1 .27 (7)	N .12 (3)	N1 .06 (2)	P Ø .13 Ø (3.3)
Q .08 (2)				
Inches (mm)				

C
 Inline Valves
 Viking Lite
 Viking Extreme
 B3, B5, B6 Series
 B7, B8 Series
 Air-Saver Unit
 "N" Series



For inventory, lead times, and kit lookup, visit www.pdnplu.com

B3 Single & Double Operators – 4-way IEM Stackable

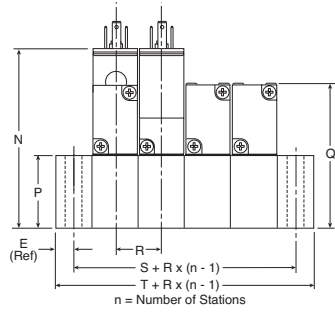
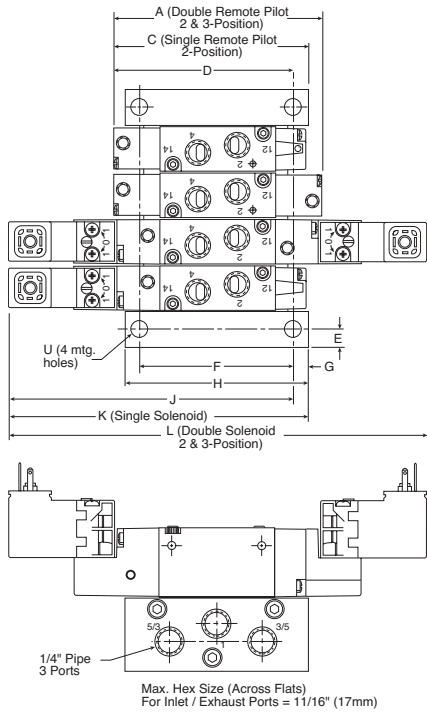

B3 4-Way IEM Stackable

A	C	D	E	F
3.33 (84.6)	3.12 (79.2)	2.91 (73.9)	.30 (7.6)	2.49 (63.3)
G	H	J	K	L
.25 (6.4)	3.00 (76.2)	4.46 (113.3)	4.67 (118.6)	6.43 (163.3)
N	P	Q	R	
2.91 (73.9)	1.25 (31.8)	2.38 (60.5)	.74 ±.01 (18.8) ± .3	
S	T	U		
1.34 (34.0)	1.94 (49.3)	Ø .28 Ø (7.1)		

Inches (mm)

B3 Single & Double Operators – 4-way IEM Aluminum Bar

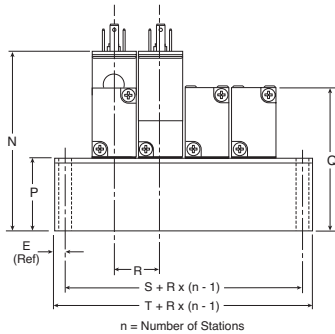
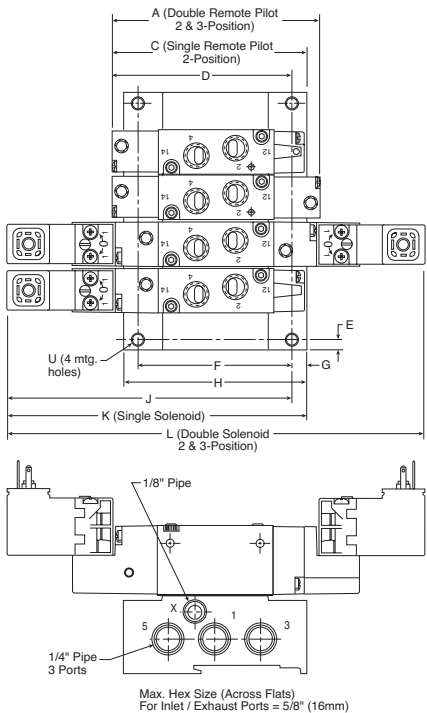

B3 4-Way IEM Aluminum Bar Manifold

A	C	D	E	F
3.33 (84.6)	3.17 (80.5)	2.94 (74.7)	.25 (6.4)	2.54 (64.5)
G	H	J	K	L
.23 (5.9)	3.00 (76.2)	4.50 (114.2)	4.73 (120.1)	6.43 (163.3)
N	P	Q	R	S
2.94 (74.7)	1.28 (32.5)	2.41 (61.2)	.81 (20.5)	1.13 (28.8)
T	U			
1.64 (41.6)	Ø .23 Ø (5.8)			

Inches (mm)



For inventory, lead times, and kit lookup, visit www.pdnplu.com

C55

Parker Hannifin Corporation
 Pneumatic Division
 Richland, Michigan
www.parker.com/pneumatics

C

Inline Valves

Viking Lite

Viking Extreme

B3, B5, B6 Series

B7, B8 Series

Air Saver Unit

"N" Series

Dimensional Data

B5 Series

B5 Single & Double Operators – 4-way Inline

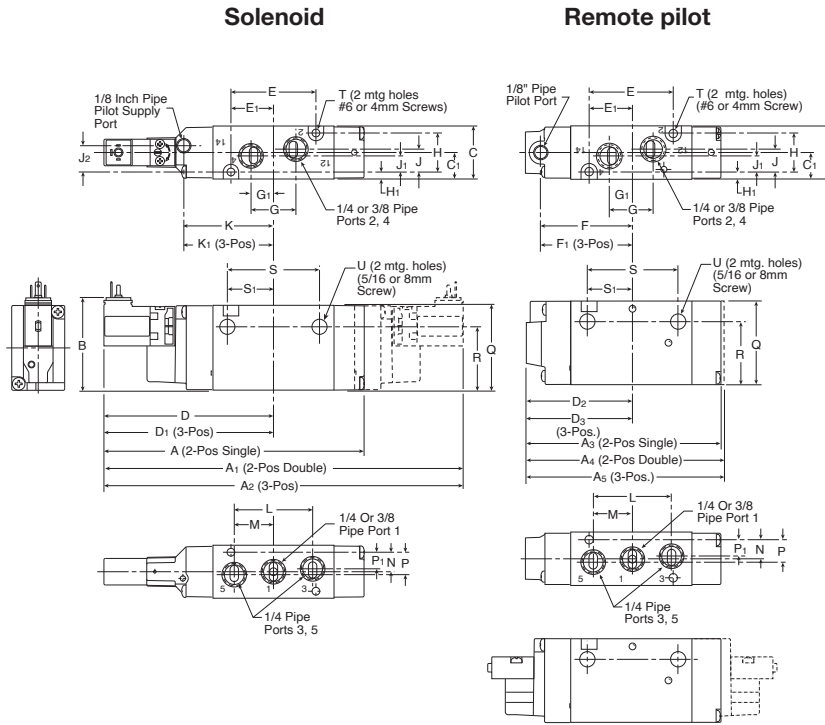

B5 4-Way Inline

A 5.78 (147)	A1 7.51 (191)	A2 8.45 (215)	A3 4.37 (110)	A4 4.70 (119)
A5 5.64 (143)	B 2.06 (52)	C 1.18 (30)	C1 .59 (15)	D 3.76 (96)
D1 4.23 (107)	D2 2.35 (60)	D3 2.82 (72)	E 1.89 (48)	E1 .95 (24)
F 2.01 (51)	F1 2.47 (63)	G 1.00 (25)	G1 .50 (13)	H .87 (22)
H1 .16 (4)	J .51 (13)	J1 .36 (9)	J .58 (15)	K 2.00 (51)
K1 2.47 (63)	L 1.75 (44)	M .88 (22)	N .43 (48)	P .50 (13)
P1 .37 (92)	Q 1.89 (48)	R 1.41 (36)	S 2.05 (52)	S1 1.03 (26)
T Ø .177 Ø (4.5)	U Ø .34 Ø (9)			

Inches (mm)

B5 Single & Double Operators – 3-way Inline

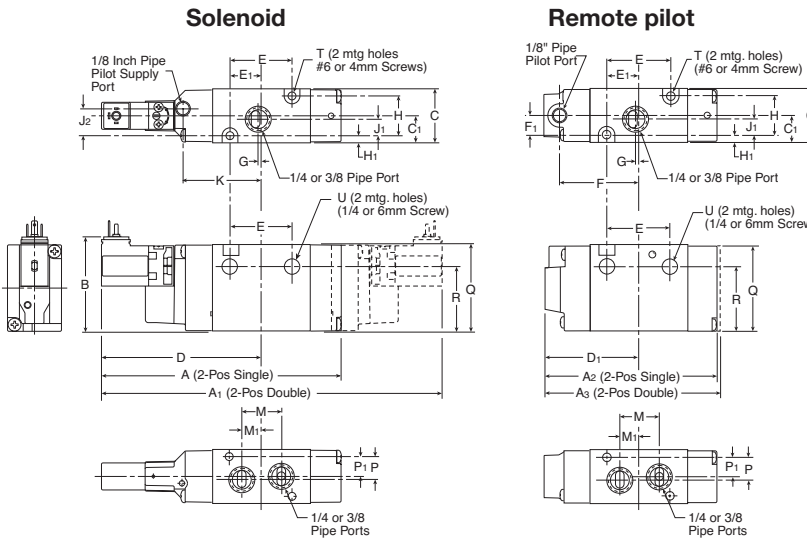

B5 3-Way Inline

A 5.29 (134)	A1 7.03 (179)	A2 3.88 (99)	A3 4.21 (107)	B 2.06 (52)
C 1.18 (30)	C1 .59 (15)	D 3.43 (87)	D1 2.11 (54)	E 1.40 (36)
E1 .70 (18)	F 1.77 (45)	F1 .43 (11)	G .06 (2)	H .87 (22)
H1 .16 (4)	J1 .36 (9)	J2 .58 (15)	K 1.67 (42)	M .88 (22)
M1 .44 (11)	P .50 (13)	P1 .37 (9)	Q 1.89 (48)	R 1.41 (36)
T Ø .177 Ø (4.5)	U Ø .26 Ø (6.6)			

Inches (mm)

C
 Inline Valves
 Viking
 Lite
 Viking
 Extreme
 B3, B5, B6
 Series
 B7, B8
 Series
 Air-Saver
 Unit
 "N"
 Series



For inventory, lead times, and kit lookup, visit www.pdnplu.com

B5 Single & Double Operators – 4-way IEM Stackable

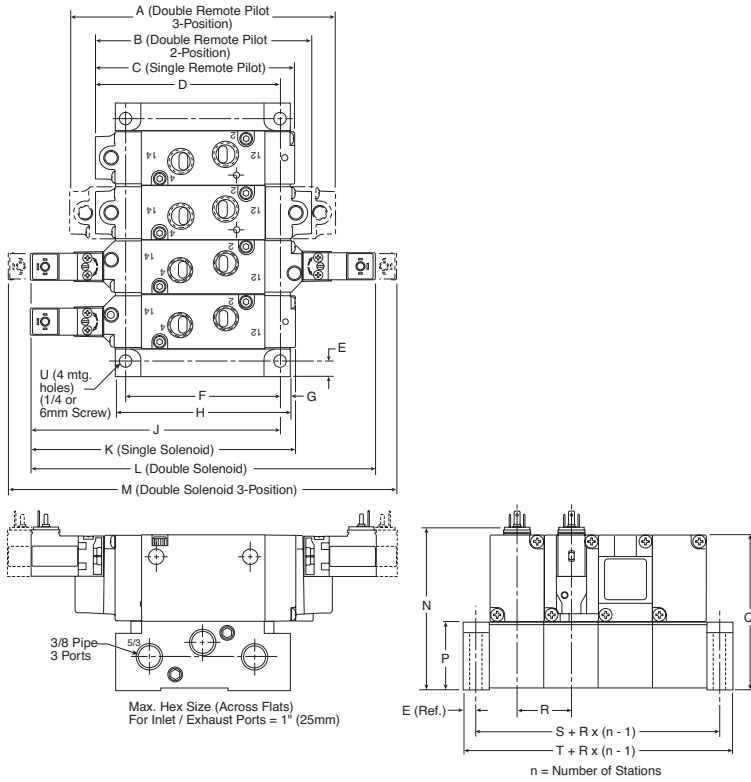

B5 4-Way IEM Stackable

A	B	C	D	E
5.64 (143.3)	4.70 (119.4)	4.37 (110.0)	4.29 (109.0)	.29 (7.4)
F	G	H	J	K
3.44 (87.4)	.24 (6.1)	3.92 (99.6)	5.48 (139.2)	5.78 (146.8)
L	M	N	P	Q
7.52 (191.0)	8.46 (214.9)	3.56 (90.4)	1.50 (38.1)	3.42 (86.9)
R	S	T	U	
1.21 ± .01 (30.7) ± (.3)	1.79 (45.5)	2.37 (60.2)	Ø .28 Ø (7.1)	

Inches (mm)

B5 Single & Double Operators – 4-way IEM Aluminum Bar

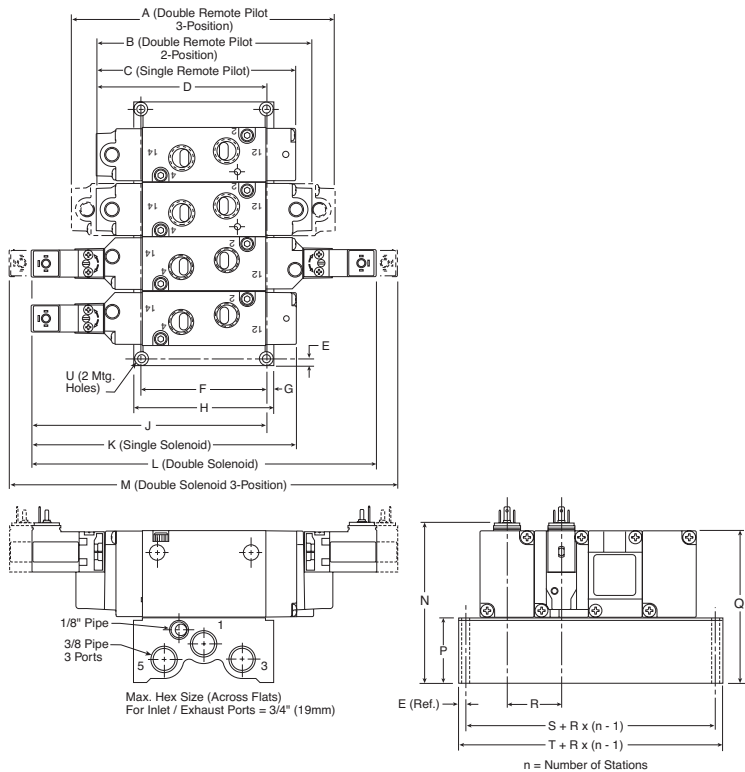

B5 4-Way IEM Aluminum Bar Manifold

A	B	C	D	E
5.64 (143.3)	4.70 (119.4)	4.37 (110.0)	3.74 (95.0)	.18 (4.6)
F	G	H	J	K
2.78 (70.6)	.17 (4.3)	3.12 (79.2)	5.15 (130.8)	5.78 (146.8)
L	M	N	P	Q
7.52 (191.0)	8.46 (214.9)	3.50 (89.0)	1.44 (36.6)	3.36 (85.3)
R	S	T	U	
1.26 (32.0)	1.78 (45.2)	2.14 (54.4)	Ø .22 Ø (5.5)	

Inches (mm)

C

Inline Valves

Viking Lite

Viking Extreme

B3, B5, B6 Series

B7, B8 Series

Air Saver Unit

"N" Series



For inventory, lead times, and kit lookup, visit www.pdnplu.com

C57

Parker Hannifin Corporation
 Pneumatic Division
 Richland, Michigan
www.parker.com/pneumatics

Dimensional Data

B6 Series

B6 Single & Double Operators – 4-way IEM Aluminum Bar

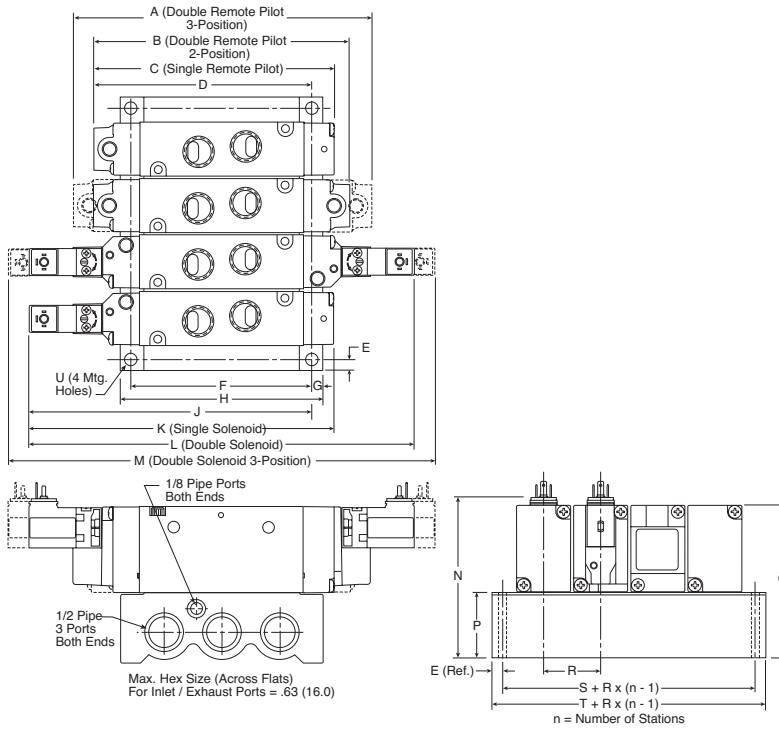

B6 4-Way IEM Aluminum Bar Manifold

A	B	C	D	E
6.54 (166.0)	5.59 (142.1)	5.26 (133.7)	4.76 (121.0)	.24 (6.0)
F	G	H	J	K
3.94 (100.0)	.24 (6.0)	4.41 (112.0)	6.17 (156.8)	6.67 (169.5)
L	M	N	P	Q
8.41 (213.7)	9.35 (237.6)	3.60 (91.3)	1.54 (39.0)	3.43 (87.0)
R	S	T	U	
1.24 (31.5)	1.77 (45.0)	2.24 (57.0)	ø .26 ø (6.5)	

Inches (mm)

C
Inline Valves
Viking Lite
Viking Extreme
B3, B5, B6 Series
B7, B8 Series
Air-Saver Unit
"N" Series



For inventory, lead times, and kit lookup, visit www.pdnplu.com

Features

B7 and B8 High Flow Inline

B7 and B8 Size valves are an exceptional performing industrial valve with a high flow range up to 7.00 Cv.

Available in solenoid pilot operated and remote air pilot models. The B series features Parker's proven WCS (Wear Compensating Seal) system ensuring long life and fast response.

Ports

- B7: 1/2 inch – 5.90 Cv
- B8: 3/4 inch – 7.00 Cv

Mounting

- Inline
- IEM aluminum bar

Solenoids

- 1.2 W – 15mm, 3-pin EN175301-803
- 2.5 to 7.3 watt - conduit, grommet, 22mm & 30mm, 3-pin DIN (433650)
- 24VDC, 120VAC
- Female DIN electrical connectors

Certification / Approval

- Approved to be CE marked
- IP65 rated
- cCSAus[‡]



Operating information

Operating pressure:	Vacuum to 145 PSIG (Vacuum to 10 bar)
Minimum:	See chart below
CSA-NRTL/C:	See chart below
Operating temperature:	5°F to 120°F (-15°C to 49°C)

Material specifications

Body	Anodized aluminum
End caps	Nylon polymer - 33% glass filled
Seals	Nitrile
Solenoid	Polyamide
Spool	Aluminum

Minimum operating pressure

Operator / Function	Internal Pilot	Minimum PSIG (kPa)	
		B7	B8
1, G, H	Single solenoid - air return	35 (241)	35 (241)
2, A, J, S	Double solenoid	35 (241)	35 (241)
3*	Single remote pilot - air return	35 (241)	35 (241)
5, 6, 7	Double solenoid - APB, CE, PC	45 (310)	45 (310)
8, 9, 0*	Double remote pilot - APB, CE, PC	Vacuum	Vacuum
V, W, X, Y*	Single remote pilot - air return / spring assist	35 (241)	35 (241)
External pilot *			
All	"B" series	Vacuum	Vacuum

* External Pilot Pressure / Remote Pilot Signal 35-145 PSIG (241-1000 kPa).

‡ CSA-NRTL/C operating pressure

Note: For CSA-NRTL/C approved solenoid valves – insert an 'L' at the end of the valve part number.

Valve	Maximum PSIG (kPa)
B7 & B8	145 (1000) ^{††}

* Enclosure Option E is CSA / FM approved at source. For certification of valve / solenoid assembly, consult factory.

† Not Available with Enclosure 5

C

Inline Valves

Viking Lite

Viking Extreme

B3, B5, B6 Series

B7, B8 Series

Air Saver Unit

"N" Series



For inventory, lead times, and kit lookup, visit www.pdnplu.com

Common Part Numbers

Single Solenoid, 3-way, 2-position, NC



Symbol	Port Size	Cv	Voltage	Valve Type	Part Number
	1/2"	5.9 Cv	120VAC 24VDC	B7 Inline	B7V3BB553A B7V3BB549A
	3/4"	7.0 Cv	120VAC 24VDC	B8 Inline	B8V4BB553A B8V4BB549A

B7 shown, 3-Pin DIN 43650C electrical connection. Non-locking flush override.

Single Solenoid, 4-way, 2-position



Symbol	Port Size	Cv	Voltage	Valve Type	Part Number
	1/2"	5.9 Cv	120VAC 24VDC	B7 Inline	B713BB553A B713BB549A
	3/4"	7.0 Cv	120VAC 24VDC	B8 Inline	B814BB553A B814BB549A

B7 shown, 3-Pin DIN 43650C electrical connection. Non-locking flush override.

Double Solenoid, 4-way, 2-position



Symbol	Port Size	Cv	Voltage	Valve Type	Part Number
	1/2"	5.9 Cv	120VAC 24VDC	B7 Inline	B723BB553A B723BB549A
	3/4"	7.0 Cv	120VAC 24VDC	B8 Inline	B824BB553A B824BB549A

B7 shown, 3-Pin DIN 43650C electrical connection. Non-locking flush override.

ANSI / (NFPA) T3.21.3-1990 standard for Cv measurement.

PS2982*##P – Enclosure '5'

	## Voltage	
Override *	49	53
B	S	S
C	S	S

Kit includes: Solenoid, (2) machine screws, (2) self threading screws, (1) gasket, (1) 3-cell gasket.

C	Inline Valves
	Viking Lite
Viking Extreme	B3, B5, B6 Series
	B7, B8 Series
Air-Saver Unit	
"N" Series	



For inventory, lead times, and kit lookup, visit www.pdnplu.com

Common Part Numbers

Double Solenoid, 4-way, 3-position, APB

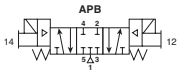
		Port Size	Cv	Voltage	Valve Type	Part Number
		1/2"	5.7 Cv	120VAC 24VDC	B7 Inline	B753BB553A B753BB549A
		3/4"	6.6 Cv	120VAC 24VDC	B8 Inline	B854BB553A B854BB549A

Double Solenoid, 4-way, 3-position, CE

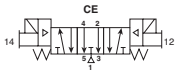
		Port Size	Cv	Voltage	Valve Type	Part Number
		1/2"	5.7 Cv	120VAC 24VDC	B7 Inline	B763BB553A B763BB549A
		3/4"	6.6 Cv	120VAC 24VDC	B8 Inline	B864BB553A B864BB549A

Double Solenoid, 4-way, 3-position, PC

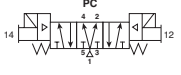
		Port Size	Cv	Voltage	Valve Type	Part Number
		1/2"	5.7 Cv	120VAC 24VDC	B7 Inline	B773BB553A B773BB549A
		3/4"	6.6 Cv	120VAC 24VDC	B8 Inline	B874BB553A B874BB549A

ANSI / (NFPA) T3.21.3-1990 standard for Cv measurement.

PS2982*##P – Enclosure ‘5’

	## Voltage	
Override *	49	53
B	S	S
C	S	S

Kit includes: Solenoid, (2) machine screws, (2) self threading screws, (1) gasket, (1) 3-cell gasket.

C	Inline Valves
	Viking Lite
	Viking Extreme
	B3, B5, B6 Series
	B7, B8 Series
	Air Saver Unit
	“N” Series



For inventory, lead times, and kit lookup, visit www.pdnplu.com

B7 & B8 Series

B7 1 3 A B G 53 - A

Basic Series	
B7 Series	B7
B8 Series	B8

Engineering Level	
A	Current
AL	CSA Current

Operator Function	
3-way	
Single Solenoid, 2-Position Nc - Air Return / Spring Assist	V
Single Solenoid, 2-Position No - Air Return / Spring Assist	W
Single Remote Pilot, 2-Position Nc - Air Return / Spring Assist	X
Single Remote Pilot, 2-Position No - Air Return / Spring Assist	Y
4-way	
Single Solenoid, 2-Position - Air Return	1
Double Solenoid, 2-Position	2
Single Remote Pilot, 2-Position - Air Return	3
Double Remote Pilot, 2-Position	4
Double Solenoid, 3-Position - APB	5
Double Solenoid, 3-Position - CE	6
Double Solenoid, 3-Position - PC	7
Double Remote Pilot, 3-Position - APB	8
Double Remote Pilot, 3-Position - CE	9
Double Remote Pilot, 3-Position - PC	0

Options	
Blank	None

	AC Voltage [§]		DC
	60Hz	50Hz	
49			24
53	120	110	

Enclosure / Lead Length	
0	None, Remote Pilot Valve
5	15mm 3-Pin DIN 43650C (male only)
A	30mm Square 3-Pin - ISO 4400 Form A (male only)
B	22mm Rectangular 3-Pin - Type B Industrial (male only)
E*	Intrinsically Safe - 30mm 3-Pin
F**	Hazardous Duty 1/2" NPT Conduit - 18" Leads
G	Grommet - 18" Leads
H	1/2" NPT Conduit - 18" Leads
N	Valve Less "A - R" Coil
X	Valve Less 15mm Solenoid

* 24 VDC & Override "A" only.
 ** 24 VDC or 120 VAC.

Port Size / Thread Type	
B7 Series	
1/2" NPT Inline	3*
1/2" BSPP "G" Inline	8*
B8 Series	
3/4" NPT Inline	4*
3/4" BSPP "G" Inline	9*

* Available for use on IEM manifolds.

Pilot Source / Pilot Exhaust	
Enclosures "0, 5 & X"	
None, Remote Pilot Valve	0
Internal - Port #1 / Vented	B [†]
External - Body / Tapped M5	K [†]
Enclosures "A, B, E, F, G, H & N"	
Internal - Port #1 / Vented	B [†]
External - Body / Tapped 1/8"	K [†]

[†] Not available for remote pilot valves.

Overrides [§]	
None, Remote Pilot Valve	0
No Override	A [†]
Flush - Non-Locking	B*
Flush - Locking	C
Valve Less 15mm Solenoid	X

* Only available with encl. "5".

[†] Only available with encl. "E".

Alternative Voltages -
 Contact Parker for voltages other than 24VDC and 120VAC

§ Enclosure '5' - Override / Voltage Availability

S - Standard
 O - Option

Voltage Code	Override Code	
	B	C
49	S	S
53	S	S

INLINE Valves -
 Only used IF an IEM Aluminum Bar Manifold requires a common external pilot signal through the manifold for low pressure / vacuum applications.

Most popular.



For inventory, lead times, and kit lookup, visit www.pdnplu.com

Accessories

IEM Bar Manifold, Inline Valves Only



Valve Series	Valve Function	## – Stations	Manifold Only (NPT)	Manifold Only (BSPP)
B7, B8	4-way / 3-way	2	P2M7BXN02NP	P2M7BXG02NP
B7, B8	4-way / 3-way	4	P2M7BXN04NP	P2M7BXG04NP
B7, B8	4-way / 3-way	6	P2M7BXN06NP	P2M7BXG06NP
B7, B8	4-way / 3-way	8	P2M7BXN08NP	P2M7BXG08NP

Kits include: (1) manifold, valve hold down bolts, gaskets. For external pilot valve option "X", external manifold galley must be pressurized. 4-Way or 3-Way valves can mount to same IEM Bar Manifold.



Inline Valves

Viking Lite

Viking Extreme

B3, B5, B6 Series

B7, B8 Series

Air Saver Unit

"N" Series

 Most popular.



For inventory, lead times, and kit lookup, visit www.pdnplu.com

Accessories

Solenoid Kits – B7 ‘A’, B8 ‘A’ 3-Pin, EN175301-803 (Former DIN 43650C), 15mm

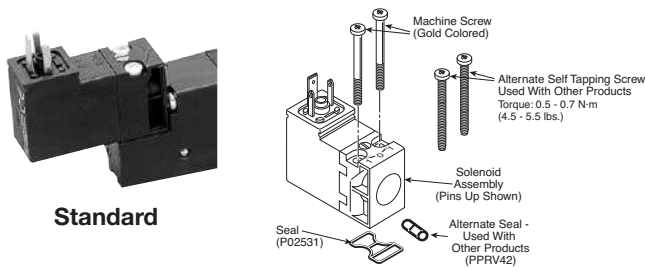

PS2982*##P – Enclosure ‘5’

	## Voltage	
Override *	49	53
B	S	S
C	S	S

S - Standard;
Kit includes: Solenoid, (2) machine screws, (2) self threading screws, (1) gasket, (1) 3-cell gasket.

Solenoid Kits Alternate Enclosures

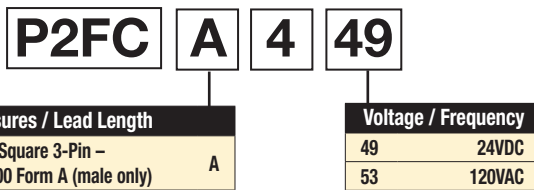

* Only available with voltage codes "45", "49", "53" & "57".



Option A & E
30mm Square
3-pin ISO 4400, DIN 43650A



Option B
22mm Rectangular
3-pin DIN, Type B Industrial



Option G
Grommet, 18"



Option F, H & R
1/2" Conduit, 18"

Most popular.

Intrinsically Safe Solenoid Valves (“E” Option)

Hazardous Location Class:
Class I; Groups A, B, C & D
Class II; Groups E, F, & G
Class III; Div. I

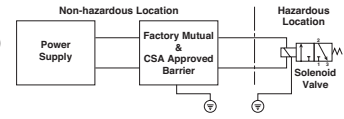

For use in low voltage (24VDC) Intrinsically Safe applications.
NO OTHER VOLTAGE IS APPROVED. 1.6W coil.

36mm coil width.

Comes standard with non-lighted solenoid connector.

Must be connected to an FM approved Barrier.

For dimensions, reference standard solenoid models.
Maximum internally piloted valve pressure is 115 PSIG.
Pressures to 145 PSIG can be used when external pilot is utilized and pilot pressure is limited to 115 PSIG.

Intrinsically Safe Solenoid Pilot Assembly Kits

Description	Part Number
24VDC	P2FS13N1AE49

Kit includes: coil, armature, connector, o-ring and screws.

Hazardous Duty Solenoid Valves (“F” Option)

Hazardous Location Class:
Class I; Zone I EX, M, II & T4
Class I; Div. I. Groups A, B, C, & D
Class II & III; Div. I. Groups E, F, & G



Comes standard with 1/2" conduit connection.

Voltage range = ± 10%, 4.6W

Ambient temperature range = -20°C (-4°F) to 60°C (140°F)

Duty factor = 100%

IP65 rated (with connected conduit connector)

Notes:

1. Maximum non-hazardous location voltage not to exceed 250V RMS.
2. Factory Mutual requires connections per ISA RP 12.6 instructions.
3. CSA requires "Installation to be in accordance with the Canadian Electrical Code. Part I."
4. The hazardous duty coils are wider in size than both the B5 and the B6 valve.
If mounted on a manifold, the valves need to be staggered to fit.

15mm 3-Pin DIN 43650C, 8mm Pin Spacing

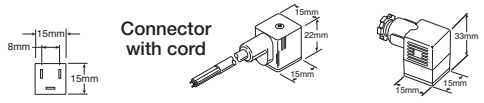

	Cord Length	Connector	Connector with Cord
Unlighted	18 Inches	PS2932BP	PS2932HBP
Unlighted	6 Feet	PS2932BP	PS2932JBP
Light – 12VAC or DC	6 Feet	PS294675BP	PS2946J75BP *
Light – 24VAC or DC	6 Feet	PS294679BP	PS2946J79BP *
Light – 110/120VAC	6 Feet	PS294683BP	PS2946J83BP *
Light – 240/230VAC		PS294687BP	N/A

* LED with surge suppression.
Note: Max ø6.5mm cable size required for connector w/o 6' (2m) cord. IP65 rated when properly installed.

Engineering data:
 Conductors: 2 poles plus ground, polarity insensitive
 Cable range (connector only): 4 to 6mm (0.16 To 0.24 Inch)
 Contact spacing: 8mm

15mm 3-Pin DIN 43650C to 1/2" Conduit

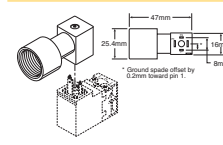

Description	Connector
1/2" NPTF conduit – Unlighted with 3' (1m) leads 20 AWG wire	PS2998P

Note: Rated up to 250VAC or VDC; 6 amps
 IP65 rated when properly installed.

**30mm Square 3-Pin – ISO 4400, DIN 43650A
 (Use with Enclosure "A")**

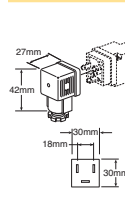

Description	Connector with 6' (2m) Cord	Connector
Unlighted	PS2028JCP	PS2028BP
Light – 6-48V, 50/60Hz, 6-48VDC	PS2032J79CP *	PS203279BP
Light – 120V/60Hz	PS2032J83CP *	PS203283BP
Light – 240V/60Hz	N/A	PS203283BP

* LED with surge suppression.
Note: Max ø6.5mm cable size required for connector w/o 6' (2m) cord. IP65 rated when properly installed.
Engineering data:
 Conductors: 2 poles plus ground; cable range (connector only): 8 to 10mm (0.31 To 0.39 Inch); contact spacing: 18mm

**22mm Rectangular 3-Pin – Type B Industrial
 (Use with Enclosure "B")**

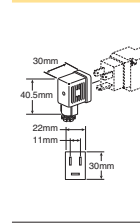

Description	Connector with 6' (2m) Cord	Connector
Unlighted	PS2429JBP	PS2429BP
Light – 24V60Hz, 24VDC	PS2430J79BP *	PS243079BP
Light – 120V/60Hz	PS2430J83BP *	PS243083BP
Light – 240V/60Hz	N/A	PS243087BP

* LED with surge suppression.
Note: Max ø6.5mm cable size required for connector w/o 6' (2m) cord. IP65 rated when properly installed.
Engineering Data:
 Conductors: 2 Poles Plus Ground; Cable Range (Connector Only): 6 to 8mm (0.24 to 0.31 Inch); Contact Spacing: 11mm

**3-Pin / 5-Pin Male Automotive Connectors
 (Use on 22mm Rectangular 3-Pin Solenoid)**

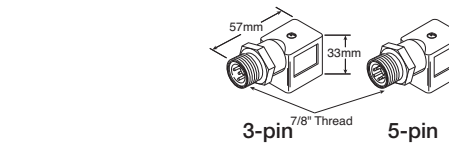

Description	3-pin	5-pin
Unlighted	PS2893CP	PS2893DP
Lighted - Voltage	PS2893C##P	PS2893D##P

— 79 = 6 to 48VAC/VDC
 83 = 100 to 240VAC/48 to 120 VDC

 Most popular.



For inventory, lead times, and kit lookup, visit www.pdnplu.com

Solenoid Information (Solenoids are rated for continuous duty.)

Voltage					Enclosure "5"					Voltage					B7, B8		B7, B8	
AC					Power Consumption	Holding (Amps)	AC					Power Consumption	Holding (Amps)	Enclosure "A"		Enclosure "B" to "H"		
Code	60Hz	50Hz	DC	Code			60Hz	50Hz	DC	Code	60Hz			50Hz	DC	Power Consumption	Holding (Amps)	Power Consumption
49			24		1.2W		.049	49			24		2.7W	.112	4.8W	.200		
53	120	110			1.6W		.013	53	120	110			4.1VA	.033	6.3VA	.047		

Response Time (Sec)

Valve Size	Port Size	Enclosure "5"				Enclosure "A, B, C, D, G, H"			
		0 Cu. In. Test Chamber		25 * Cu. In. Test Chamber		0 Cu. In. Test Chamber		25 * Cu. In. Test Chamber	
		Fill	Exhaust	Fill	Exhaust	Fill	Exhaust	Fill	Exhaust
2-Position Single Solenoid / Internal Air Return									
B7	1/2"	.073	.075	.195	.275	.049	.051	.167	.249
B8	3/4"	.072	.074	.166	.226	.049	.051	.142	.206
2-Position Single Solenoid Spring / Air Return									
B7	1/2"	.071	.074	.194	.275	.049	.051	.167	.249
B8	3/4"	.072	.074	.176	.239	.046	.048	.142	.204
2-Position Double Solenoid									
B7	1/2"	.026	.028	.145	.228	.022	.024	.138	.225
B8	3/4"	.026	.028	.123	.185	.022	.024	.115	.178
3-Position Double Solenoid									
B7	1/2"	.049	.051	.167	.257	.028	.030	.148	.238
B8	3/4"	.035	.037	.136	.206	.028	.030	.130	.195

Average Fill Time (Seconds): With 100 PSIG supply, time required to fill from 0-90 PSIG and exhaust from 100 PSIG to 10 PSIG is measured from instant of energizing, or de-energizing 120V/60Hz solenoid. Times shown are average.

C
Inline Valves
Viking Lite
Viking Extreme
B3, B5, B6 Series
B7, B8 Series
Air-Saver Unit
"N" Series



For inventory, lead times, and kit lookup, visit www.pdnplu.com

Alternate Solenoid Enclosures

- Enclosure "A": 2.6W - 4.1VA (Coil rotates in 45° increments)
- Enclosure "B" - "H": 4.6W - 7.3VA (Coil rotates in 90° increments)



"A" 30mm 3-Pin



"G" Grommet



"B" 22mm 3-Pin



**"F". "H". 1/2"
 Conduit**



Inline Valves

Viking
 Lite

Viking
 Extreme

B3, B5, B6
 Series

B7, B8
 Series

Air Saver
 Unit

"N"
 Series



B7A / B8A Series

Spool / Body Service Kits

PS2501P	4-Way, 2-Pos	Item 2, 6 (2), 9 (2), 11, grease packet
PS2502P	4-Way, 3-Pos APB	Item 3, 6 (2), 9 (2), 13 (2), grease packet
PS2503P	4-Way, 3-Pos CE	Item 3, 6 (2), 9 (2), 13 (2), grease packet
PS2504P	4-Way, 3-Pos PC	Item 3, 6 (2), 9 (2), 13 (2), grease packet
PS257101P	3-Way, 2-Pos. NC	Item 2, 6, 9, grease packet
PS257102P	3-Way, 2-Pos. NO	Item 2, 6, 9, grease packet

Kit Includes:

Armature / Override Kit –

Kit Includes: Item 22, 23, 24 (2), 57, 58 Assembled

P2FP13N4D* Non-Locking P2FP13N4C* Locking

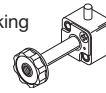

* Comes with a Thru Nut and A Diffuser Nut.

Valve to Manifold Kits

PS2584P	O-ring (10) - Inline Valve to IEM Manifold
PS2587P	Mounting Bolts (10) - Inline Valve

Solenoid Kit *Kit Includes: 25, 122, 123*

PS2982*##P	3-Pin, EN175301-803, 15mm
PS3541*##P	3-Pin, EN175301-803, 15mm Option 2

Pilot Replacement Kit – Alternate Enclosure

Kit Includes: Item 6, 8, 9, 10, 16 (4), 18, 20, 22, 23, 24 (2), 57, 58 Assembled

PS2597GBP	Non-Locking, BSPP
PS2597GCP	Locking, BSPP
PS2597NBP	Non-Locking, NPT
PS2597NCP	Locking, NPT

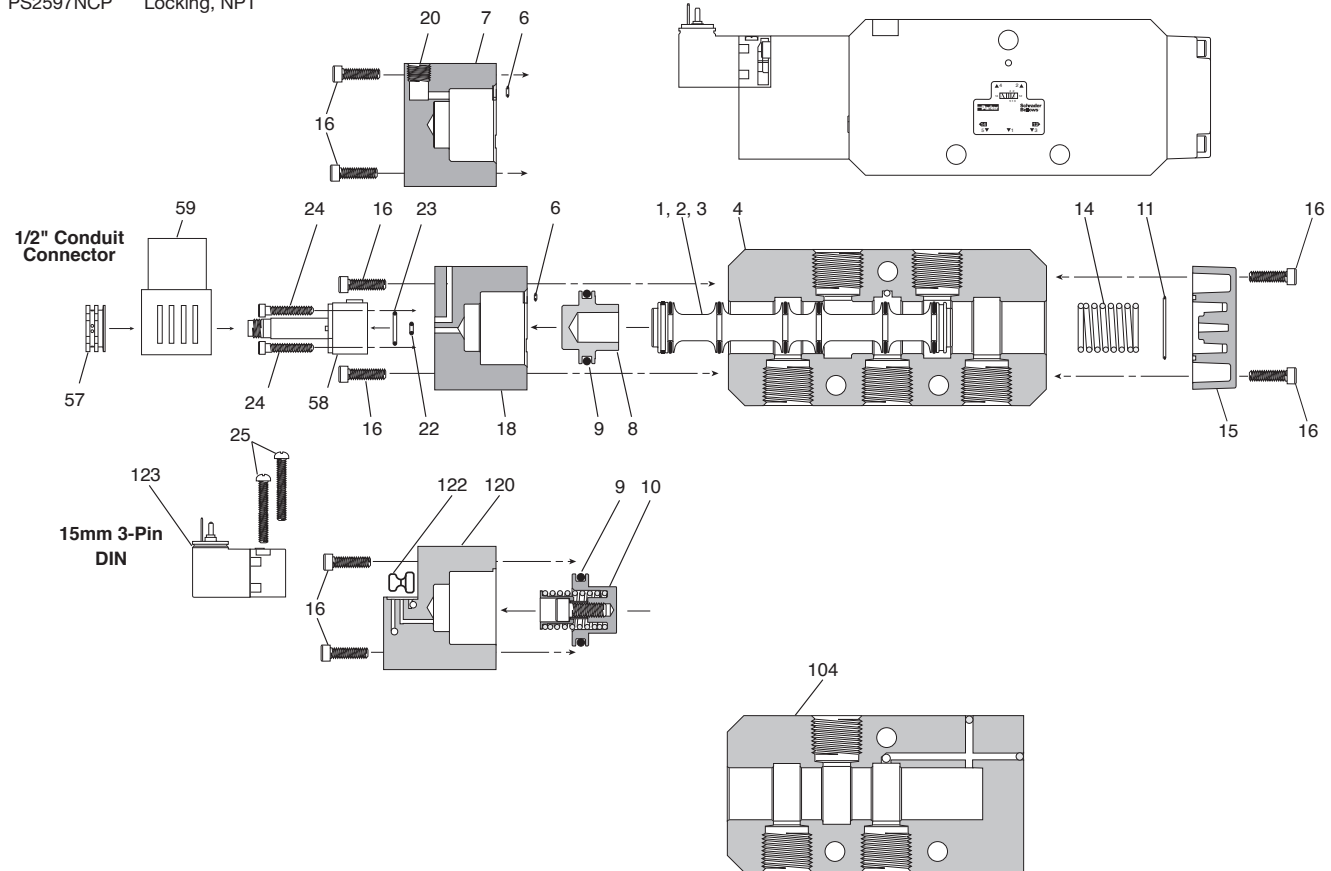
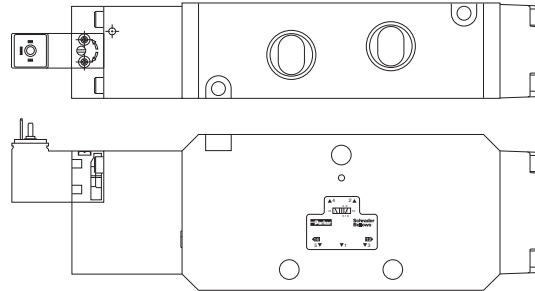

Item List – Parts not sold separately.

Item	Description	Item	Description	Item	Description
1*	Spool Seal	15a	Return Operator	58b*	Solenoid Base Assembly - Non Locking
2*	Spool - 2-Position (Seals Assembled)	16*	Screws - Operator Adapter	59*	Coil - Alternate Enclosure (see Page C51)
3*	Spool - 3-Position (Seals Assembled)	8*	Operator Adapter - Alt Enclosure	104	Inline Body - 3-Way
4	Inline Body - 4-Way	20*	1/8" NPT Pipe Plug	120a	Solenoid Adapter - Vent Exhaust
6*	Gasket - Body to Operator	22*	O-ring - Small - Solenoid Base	120b	Solenoid Adapter - Tapped Exhaust
7	Remote Pilot Operator	23*	O-ring - Large - Solenoid Base	120c	Solenoid Adapter - Ext Pilot. Vent Exhaust
8	Operator Piston - 2-Position	24*	Bolts - Solenoid Base	120d	Solenoid Adapter - Ext Pilot. Tapped Exhaust
9*	Lip Seal - Operator Piston	25*	Self Tapping Screw - Solenoid (Effective Jan 00)	122*	Gasket - Solenoid to Adapter
10	Operator Piston Mechanism - 3-Position	57*	Solenoid Nut	123*	15mm Solenoid
11*	Gasket - Body to Return Cap	58a*	Solenoid Base Assembly - Locking		
14*	Spring, Return Assist				

Note: * Parts are available in kits shown. For kit components, order VALVE LESS SOLENOID for assembled and tested repair valve.



For inventory, lead times, and kit lookup, visit www.pdnplu.com

Dimensional Data

B7 & B8 High Flow Inline

B7& B8 Single & Double Operators – 4-way Inline

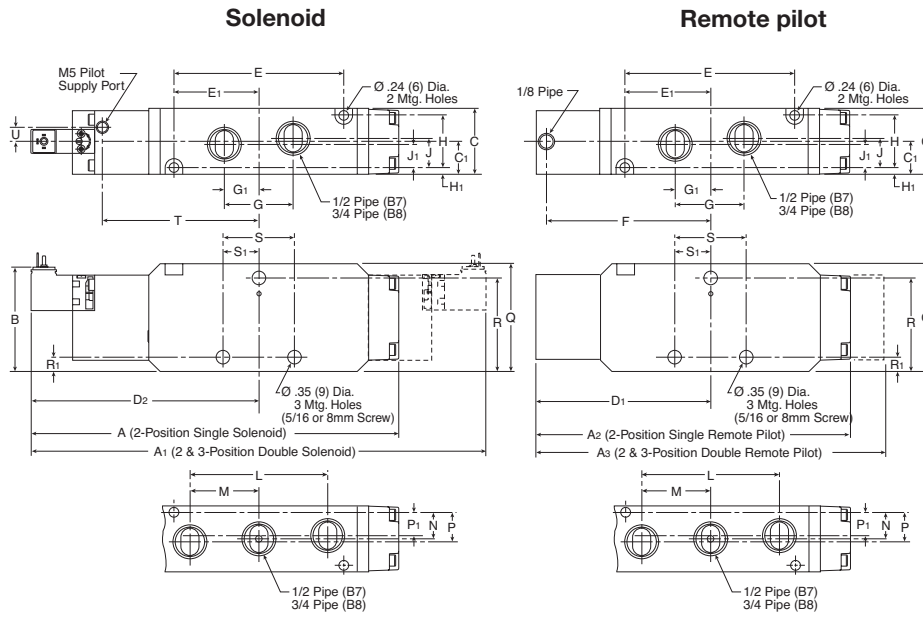

B7 & B8 4-Way Inline

A 9.13 (232)	A1 11.29 (287)	A2 7.79 (198)	A3 8.62 (219)	B 2.59 (66)
C 1.65 (42)	C1 .83 (21)	D1 4.29 (109)	D2 5.63 (143)	E 4.21 (107)
E1 2.13 (54)	F 4.06 (103)	G 1.73 (44)	G1 .87 (22)	H 1.29 (33)
H1 .16 (4)	J .75 (19)	J1 .59 (15)	L 3.39 (86)	M 1.69 (43)
N .67 (17)	P .75 (19)	P1 .59 (15)	Q 2.68 (68)	R 2.32 (59)
R1 .35 (9)	S 1.81 (46)	S1 .90 (23)	T 3.94 (100)	U .35 (9)

Inches (mm)

C

Inline Valves

Viking Lite

Viking Extreme

B3, B5, B6 Series

B7, B8 Series

Air Saver Unit

"N" Series



For inventory, lead times, and kit lookup, visit www.pdnplu.com

B7 & B8 Single Operators – 3-way Inline

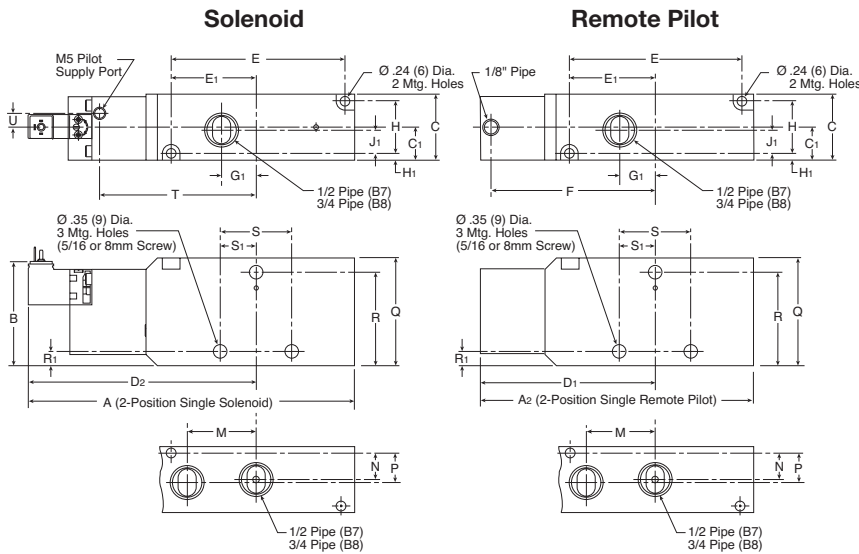

B7 & B8 3-Way Inline

A	A₂	B	C	C₁
7.99 (203)	6.65 (169)	2.59 (66)	1.65 (42)	.83 (21)
D₁	D₂	E	E₁	F
4.29 (109)	5.63 (143)	4.21 (107)	2.13 (54)	4.06 (103)
G₁	H	H₁	J₁	M
.86 (22)	1.29 (33)	.16 (4)	.59 (15)	1.69 (43)
N	P	Q	R	R₁
.67 (17)	.75 (19)	2.68 (68)	2.32 (59)	.35 (9)
S	S₁	T	U	
1.81 (46)	.90 (23)	3.94 (100)	.35 (9)	

Inches (mm)

B7 & B8 Single & Double Operators – 4-way IEM Aluminum Bar

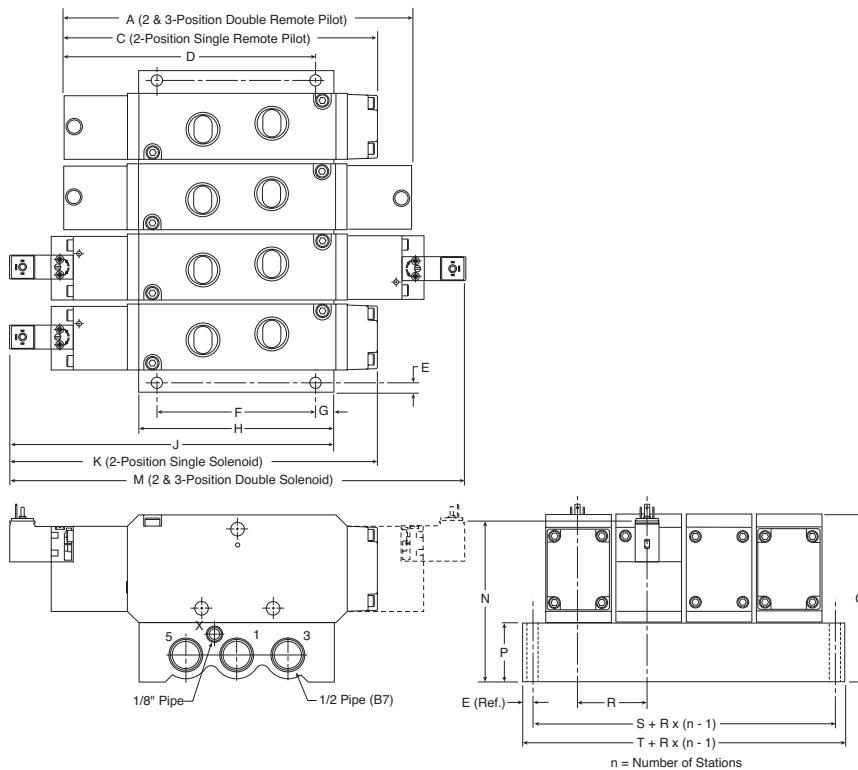

B7 & B8 4-Way IEM Aluminum Bar Manifold

A	C	D	E	F
7.79 (198)	8.62 (219)	6.26 (159)	.24 (6)	3.94 (100)
G	H	J	K	M
.45 (11.5)	4.84 (123)	8.07 (205)	9.13 (232)	11.29 (287)
N	P	Q	R	S
4.00 (101.5)	1.48 (37.5)	4.15 (105.5)	1.77 (45)	2.24 (57)
T				
2.72 (69)				

Inches (mm)

B7 & B8 Single Operators – 3-way IEM Aluminum Bar

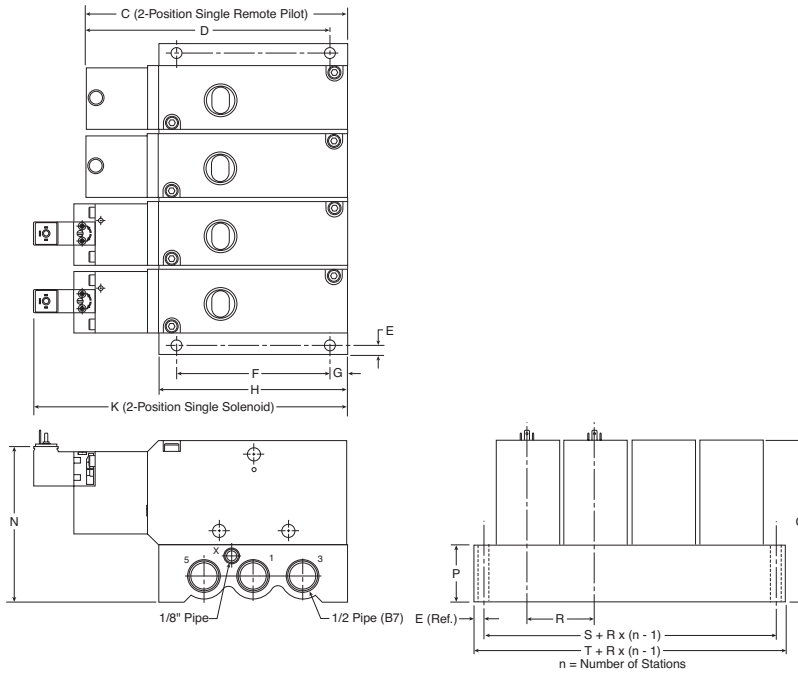

B7 & B8 3-Way IEM Aluminum Bar Manifold

C	D	E	F	G
6.65 (169)	4.92 (124.9)	.24 (6)	3.94 (100)	.45 (11.5)
H	K	N	P	Q
4.84 (123)	7.99 (203)	4.00 (101.5)	1.48 (37.5)	4.15 (105.5)
R	S	T		
1.77 (45)	2.24 (57)	2.72 (69)		

Inches (mm)

B7 & B8 3 & 4-way Alternative Electrical Enclosures

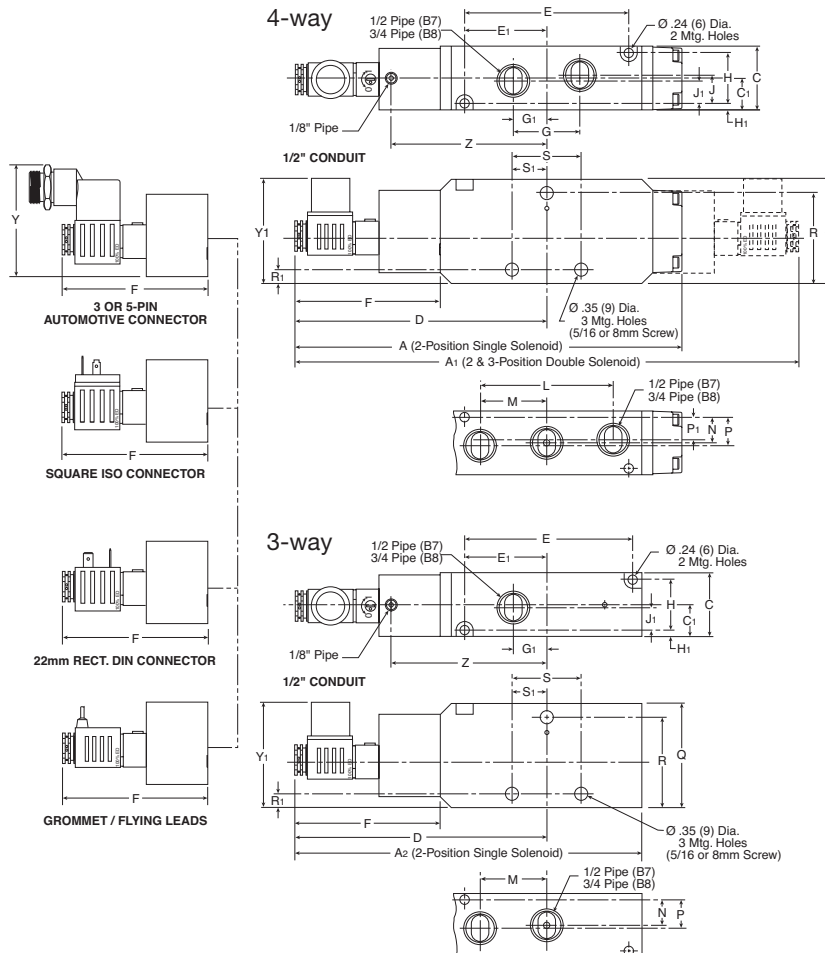

B7 & B8 3 & 4-Way Alternative Electrical Enclosures

A	A ₁	A ₂	C	C ₁
9.92 (252)	12.91 (328)	8.78 (223)	1.65 (42)	.83 (21)
D	E	E ₁	F	G
6.46 (164)	4.21 (107)	2.13 (54)	3.74 (95)	1.73 (44)
G ₁	H	H ₁	J	J ₁
.86 (22)	1.29 (33)	.16 (4)	.75 (19)	.59 (15)
L	M	N	P	P ₁
3.39 (86)	1.69 (43)	.67 (17)	.75 (19)	.59 (15)
Q	R	R ₁	S	S ₁
2.68 (68)	2.32 (59)	.35 (9)	1.81 (46)	.90 (23)
Y	Y ₁	Z		
2.87 (73)	2.71 (69)	3.98 (101)		

Inches (mm)



For inventory, lead times, and kit lookup, visit www.pdnplu.com

C71

Parker Hannifin Corporation
 Pneumatic Division
 Richland, Michigan
www.parker.com/pneumatics

C

Inline Valves

Viking Lite

Viking Extreme

B3, B5, B6 Series

B7, B8 Series

Air Saver Unit

"N" Series

Features

An easy solution to your environmental protection efforts!
The Air Saver Unit contributes to power savings and CO₂ reduction.

Parker Air Saver Unit

Up to
50%*
Savings!

Pulsing air technology reduces consumption.

The Air Saver Unit is a valve that converts a continuous air blow to a pulsed air blow without the need for any other external control. Air is blown with a series of ON and OFF pulses. When the blow is OFF, there is no air consumption.

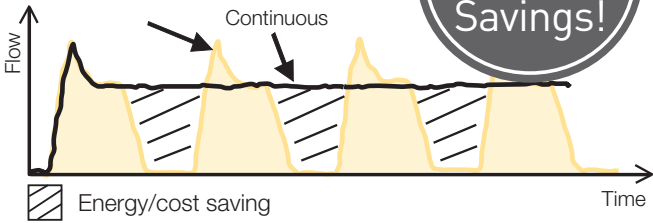

When using an Air Saver Unit several significant benefits can be achieved. Air blowing accounts for almost 50% of all compressed air used in plants. By using switching valve technology the Air Saver Unit can reduce air consumption by up to 50%!

* To achieve the benefits of pulsed air, the Air Saver Unit should be installed no more than 3 meters away from the air blow orifice. For optimal results install within 1 meter.

- Large reductions in air consumption.
- Savings in compressor power consumption.
- Reduction in plant CO₂ emissions.
- Big contribution to energy-saving activities.
- Improved efficiency.



C
 Inline Valves
 Viking Lite
 Viking Extreme
 B3, B5, B6 Series
 B7, B8 Series
 Air Saver Unit
 "N" Series

Try our fast and easy online savings calculator! www.linktovms.com/airsaver

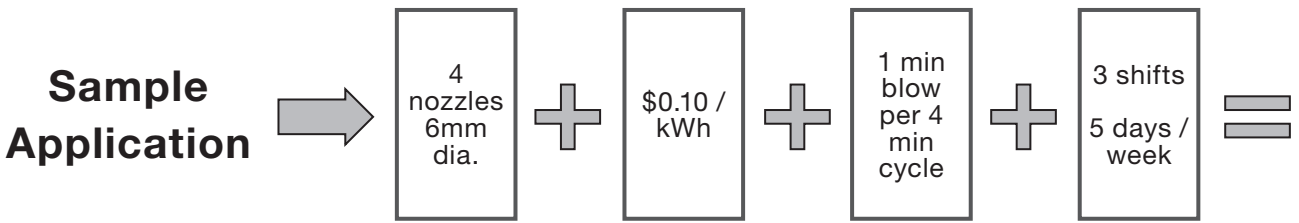

ENGINEERING YOUR SUCCESS.

Prepared for _____ Prepared by _____ **Air Saver Unit Valve Calculator**
Summary Sheet

VALUE IMPACT SUMMARY

Reduced Total Annual Air Discharge Per Blowing Nozzle (cfm) by:	3,232,005
Reduced Annual CO ₂ Emissions Generated (Per Blowing Nozzle - in Tons) by:	5.77 tons
Reduced Annual Air Generating Costs Per Blowing Nozzle by:	\$ 892.03
Quantity of Air Blowing Nozzles With Same Application Specifications	4
Reduced Annual Air Generating Costs For All Nozzles by:	\$ 3,568.13
Reduced Annual CO ₂ Emissions Generated (For All Blowing Nozzles) by:	23.07



For inventory, lead times, and kit lookup, visit www.pdnplu.com

Features

Installation is simple and reduction in air consumption can be realized immediately.

- When using an electrically operated solenoid valve to control the air blow, an Air Saver Unit can quickly and easily be retrofitted providing an immediate reduction in air consumption with no changes to the PLC program.

Before introduction of the unit

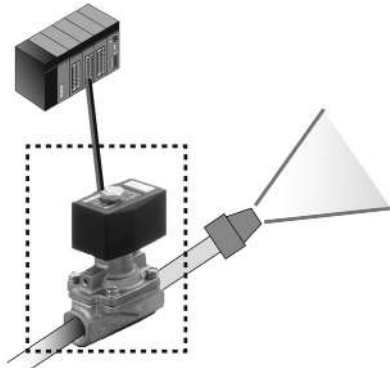

After introduction of the unit

- Easy to install. Change the current solenoid valve to Air Saver Unit. (ASC500 or ASO500)
- Program change of controller is not necessary.

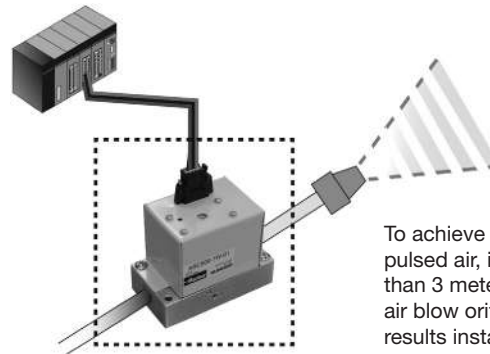

To achieve the benefits of pulsed air, install no more than 3 meters away from the air blow orifice. For optimal results install within 1 meter.

- When using manual valves such as ball valves, simply install either ASV200, ASV500 or ASV2000 units which do not need electrical power. Installing the unit brings immediate reduction in air consumption and improved compressor efficiency.

Before introduction of the unit

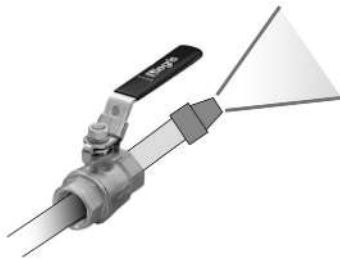

After introduction of the unit

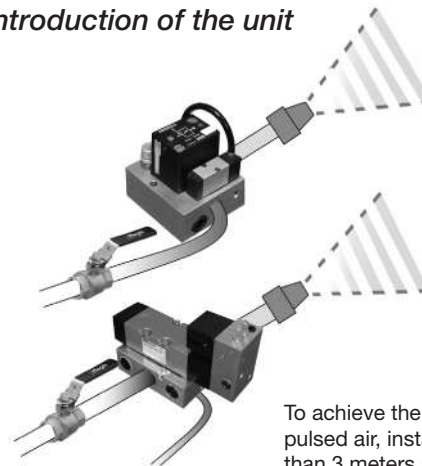

To achieve the benefits of pulsed air, install no more than 3 meters away from the air blow orifice. For optimal results install within 1 meter.

[Company A] Food & Beverage manufacturer

“When we tested ASV5000, we achieved about 55% reduction of our air consumption. Because air blow efficiency was improved, we plan to use more Air Saver Units in other areas in the plant”.







[Company B] Manufacturer of office document machines

“We are working on energy-saving activities. In those activities, we decided to use an Air Saver Unit. We have more than 100 points of air blow and we reduced our air consumption by 42% using this unit”.



C	Inline Valves
	Viking Lite
	Viking Extreme
	B3, B5, B6 Series
	B7, B8 Series
	Air Saver Unit
	“N” Series

Specifications

								Unit
Function	Normally closed						Normally open	--
Fluid	Non lubricated air							--
Flow (at 72.5 psi)	5.3	70.6	176.6	459.1	529.7	15.9	15.9	scfm
Adjustable Pulse Frequency	Up to 5	Up to 5	Up to 5	Up to 1	Up to 1	2-22	2-22	Hz
Port Size	M5	3/8"	1/2"	1"	1-1/4"	1/8"	1/8"	NPT (BSPP)
Operating Temperature	23 to 122							° F
Pressure Range	43.5 - 116	0 - 116				29 - 101.5	29 - 72.5	PSI
Pilot Air Supply	Internal pilot	43.5 - 116 *				Internal pilot		PSI
Blow	Pulse blow					Pulse/Continuous blow		--
Rated Voltage	Electrical power is not necessary					DC 24 V		V
Power Consumption	-					1.2 W		W
Grade Of Insulation	-					NEMA 1		--
Permissible Voltage Fluctuation	-					+ or - 10		%
Wiring	-					e-CON standard 4 pole sockets		--
Filtration	Dry w/ 40 µm filtration †							--

Notes:

- * External pilot of 43.5 - 116 is required, to ensure proper operation.
- † For maximum life of the unit we recommend 5 micron, but 40 micron filtration is acceptable and will not void warranty.

To achieve the benefits of pulsed air, the Air Saver Unit should be installed no more than 3 meters away from the air blow orifice. For optimal results install within 1 meter.

C
 Inline Valves
 Viking Lite
 Viking Extreme
 B3, B5, B6 Series
 B7, B8 Series
 Air Saver Unit
 "N" Series



For inventory, lead times, and kit lookup, visit www.pdnplu.com



Ordering Information ASV200-AA-M5

Function	Fluid	Flow @ 72.5 psi	Port Size	Operating Temperature	Pressure Range, psi	Pilot air Supply, psi	Blow Type	Grease	Part Number
Normally closed	Dry air	5.3 scfm	M5	23-122°F (A)	43.5-116	Internal pilot	Pulse	Food grade	ASV200-AA-M5
								Petrolatum (B), (for painting applications) (C), (D)	WPASV200-AA-M5

Dimensions: ASV200-AA-M5

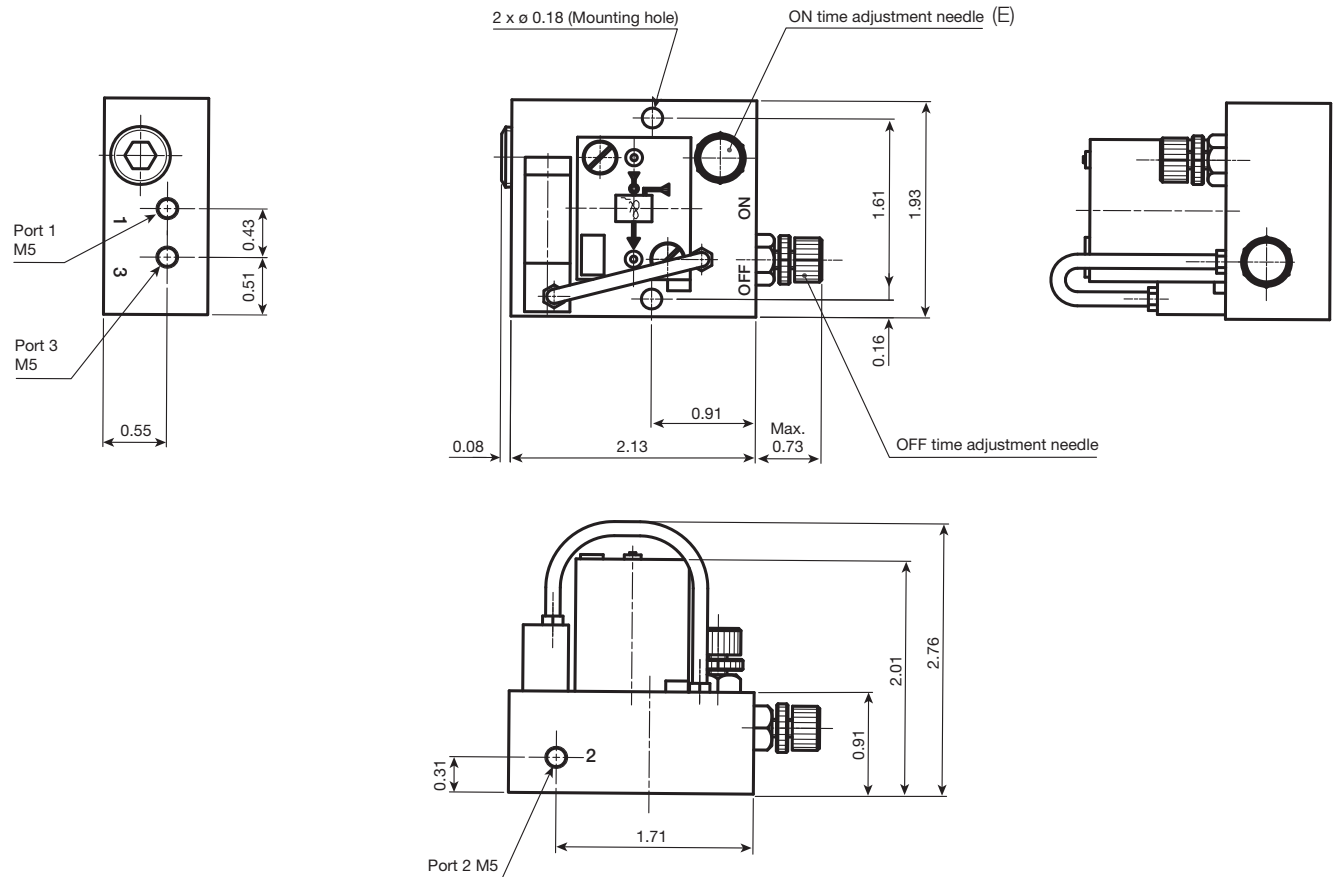

Piping

- Port 1: Supply port (Compressor side)
- Port 2: Output port (Blow nozzle side)
- Port 3: Exhaust port*

* In order to keep out dust, the air muffler is recommended for exhaust port.

Notes:

- A. When temperature of valve goes below 5°C (41°F), complete dry air shall be supplied to prevent from freezing.
- B. Air Saver Units with WP prefix are suitable for most painting applications. Test before use if in direct contact with painted surface.
- C. If test in painting application fails, try cycling Air Saver Unit for 48 hours and repeat test.
- D. DO NOT use "WP" Air Saver Unit in 'clear coat' applications.
- E. Adjustable to maximum frequency of 5Hz.

Most popular.



For inventory, lead times, and kit lookup, visit www.pdnplu.com

C75

Parker Hannifin Corporation
Pneumatic Division
Richland, Michigan
www.parker.com/pneumatics

C
Inline Valves
Viking Lite
Viking Extreme
B3, B5, B6 Series
B7, B8 Series
Air Saver Unit
"N" Series



Ordering Information ASV2000-AA-xx

Function	Fluid	Flow @ 72.5 psi	Port Size	Operating Temperature	Pressure Range, psi	Pilot air Supply, psi	Blow Type	Grease	Port Type	Part Number
Normally closed	Dry air	70.6 scfm	3/8"	23-122°F (A)	0-116	43.5-116	Pulse	Standard	NPT	ASV2000-AA-97
									BSP	ASV2000-AA-17
									NPT (B), (C)	WPASV2000-AA-97
									BSP (D)	WPASV2000-AA-17

Dimensions: ASV2000-AA-97 (NPT model)

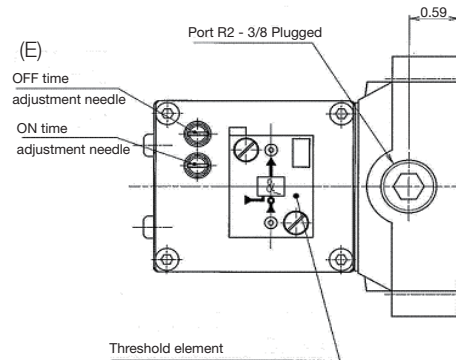
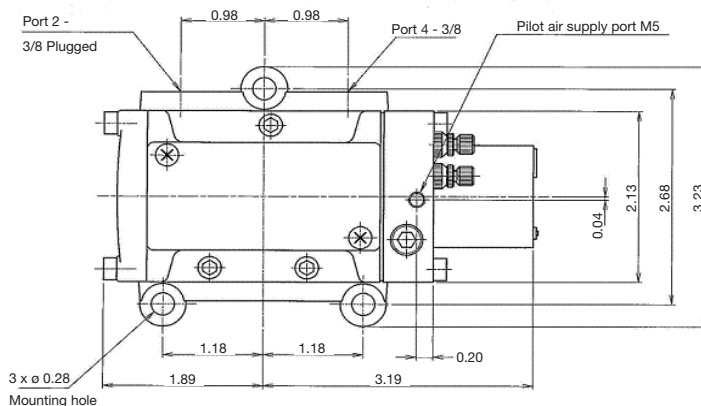

Piping

- Port 1: Supply port (Compressor side)
- Port 2: Plugged
- Port 3: Plugged
- Port 4: Output port (Blow nozzle side)
- Port R2: Plugged
- Port X: M5 pilot air supply >43.5 psi is required

Notes:

- A. When temperature of valve goes below 5°C (41°F), complete dry air shall be supplied to prevent from freezing.
- B. Air Saver Units with WP prefix are suitable for most painting applications. Test before use if in direct contact with painted surface.
- C. If test in painting application fails, try cycling Air Saver Unit for 48 hours and repeat test.
- D. DO NOT use "WP" Air Saver Unit in 'clear coat' applications.
- E. Adjustable to maximum frequency of 5Hz.

Most popular.



For inventory, lead times, and kit lookup, visit www.pdnplu.com



Ordering Information ASV5000-AA-xx

Function	Fluid	Flow @ 72.5 psi	Port Size	Operating Temperature	Pressure Range, psi	Pilot air Supply, psi	Blow Type	Grease	Port Type	Part Number
Normally closed	Dry air	176.6 scfm	1/2"	23-122°F (A)	0-116	43.5-116	Pulse	Food grade	NPT	ASV5000-AA-91
									BSPP	ASV5000-AA-21
									NPT	WPASV5000-AA-91
									BSPP	WPASV5000-AA-21

Dimensions: ASV5000-AA-91 (NPT model)

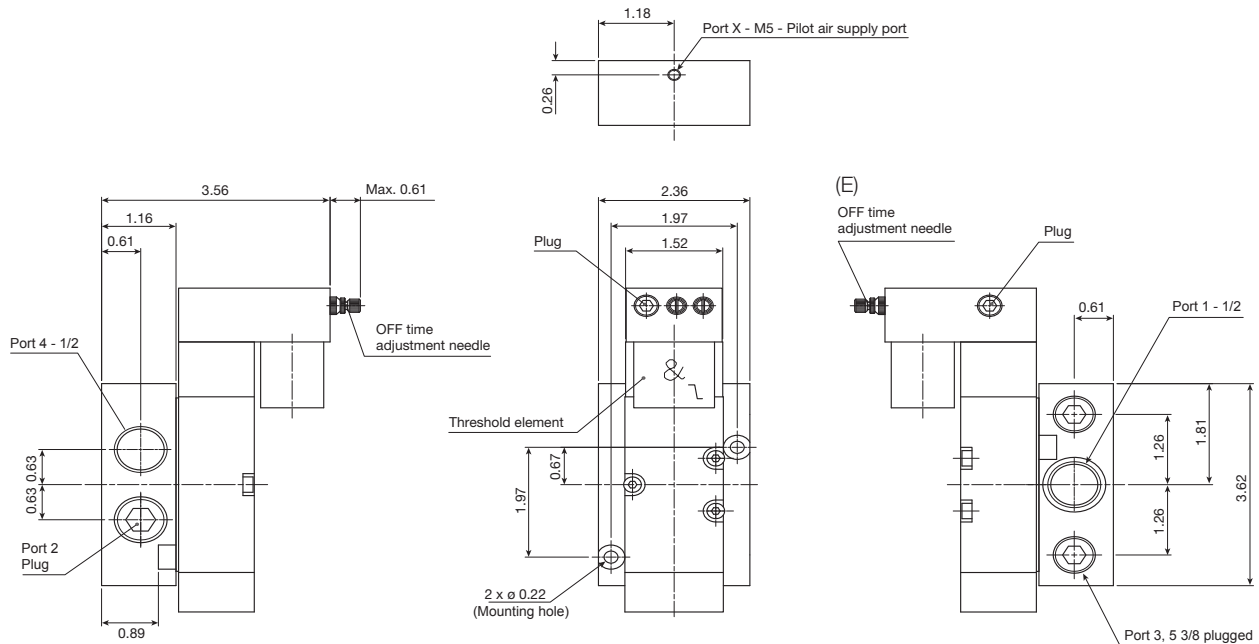

Piping

- Port 1: Supply port (Compressor side)
- Port 2: Plugged
- Port 3: Plugged
- Port 4: Output port (Blow nozzle side)
- Port 5: Plugged
- Port X: M5 pilot air supply >43.5 psi is required

Notes:

- A. When temperature of valve goes below 5°C (41°F), complete dry air shall be supplied to prevent from freezing.
- B. Air Saver Units with WP prefix are suitable for most painting applications. Test before use if in direct contact with painted surface.
- C. If test in painting application fails, try cycling Air Saver Unit for 48 hours and repeat test.
- D. DO NOT use "WP" Air Saver Unit in 'clear coat' applications.
- E. Adjustable to maximum frequency of 5Hz.

Most popular.



For inventory, lead times, and kit lookup, visit www.pdnplu.com

C77

Parker Hannifin Corporation
Pneumatic Division
Richland, Michigan
www.parker.com/pneumatics

C

Inline Valves

Viking Lite

Viking Extreme

B3, B5, B6 Series

B7, B8 Series

Air Saver Unit

"N" Series



Ordering Information ASV13000-AA-xx

Function	Fluid	Flow @ 72.5 psi	Port Size	Operating Temperature	Pressure Range, psi	Pilot air Supply, psi	Blow Type	Grease	Port Type	Part Number
Normally closed	Dry air	459.1 scfm	1"	23-122°F (A)	0-116	43.5-116	Pulse	Petrolatum (for painting applications)	(B), NPT	WPASV13000-AA-94
									(C), BSPP	WPASV13000-AA-34

Dimensions: ASV13000-AA-94 (NPT model)

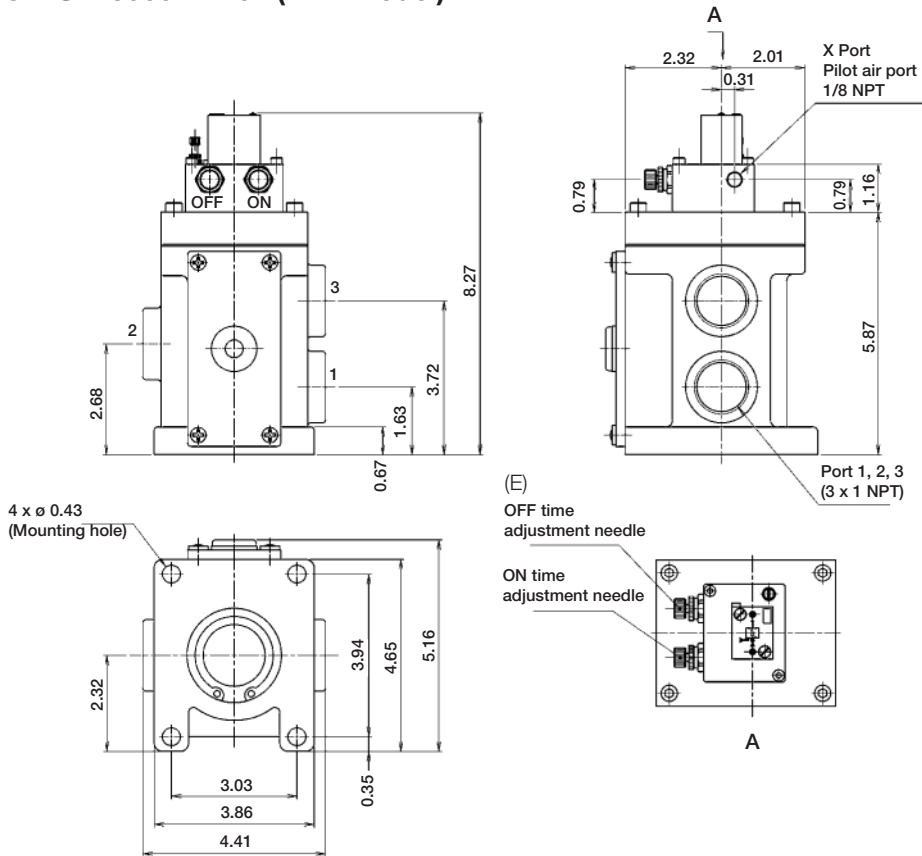

Piping

- Port 1: Supply port (Compressor side)
- Port 2: Output port (Blow nozzle side)
- Port 3: Plugged
- Port X: 1/8 NPT pilot air supply >43.5 psi is required

Notes:

- A. When temperature of valve goes below 5°C (41°F), complete dry air shall be supplied to prevent from freezing.
- B. Air Saver Units with WP prefix are suitable for most painting applications. Test before use if in direct contact with painted surface.
- C. If test in painting application fails, try cycling Air Saver Unit for 48 hours and repeat test.
- D. DO NOT use "WP" Air Saver Unit in 'clear coat' applications
- E. Adjustable to maximum frequency of 1Hz.

Most popular.



For inventory, lead times, and kit lookup, visit www.pdnplu.com



Ordering Information ASV15000-AA-xx

Function	Fluid	Flow @ 72.5 psi	Port Size	Operating Temperature	Pressure Range, psi	Pilot air Supply, psi	Blow Type	Grease	Port Type	Part Number
Normally closed	Dry air	529.7 scfm	1-1/4"	23-122°F (A)	0-116	43.5-116	Pulse	Petrolatum (B), (for painting applications) (C), (D)	NPT	WPASV15000-AA-92
									BSPP	WPASV15000-AA-42

Dimensions: ASV15000-AA-92 (NPT model)

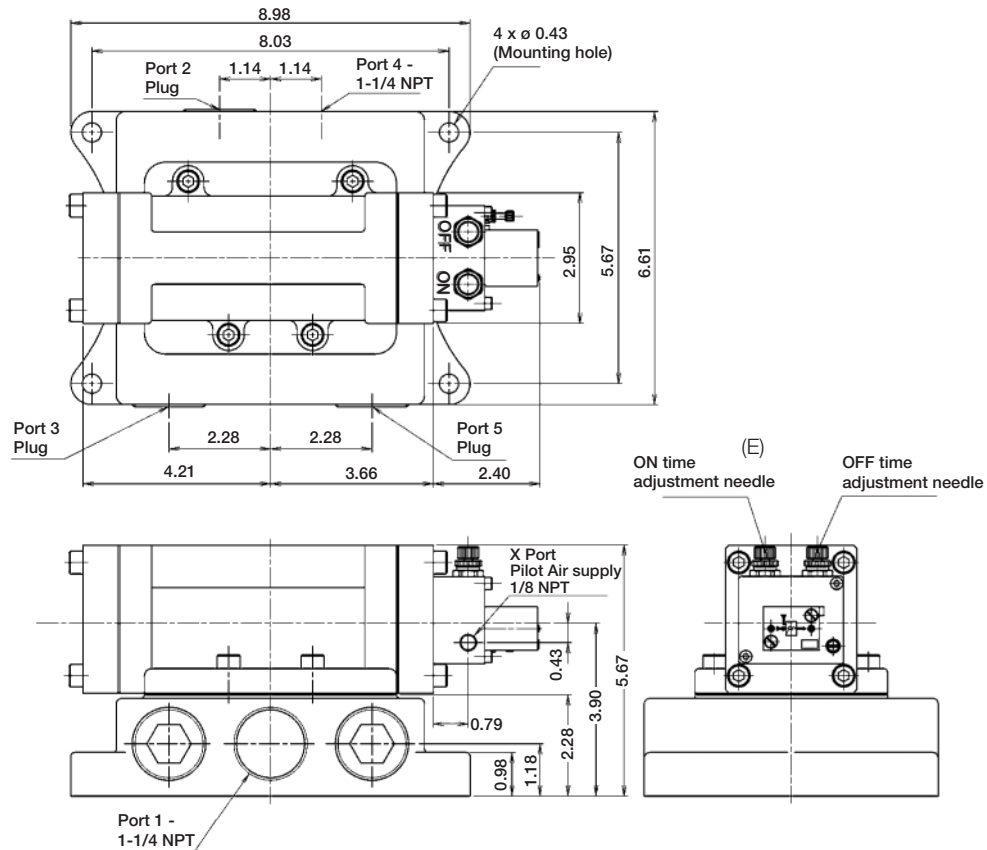

Piping

- Port 1: Supply port (Compressor side)
- Port 2: Plug (1-1/4)
- Port 3: Plug (1-1/4)
- Port 4: Output port (Blow nozzle side)
- Port 5: Plug (1-1/4)
- Port X: 1/8 NPT pilot air supply
>43.5 psi is required

Notes:

- A. When temperature of valve goes below 5°C (41°F), complete dry air shall be supplied to prevent from freezing.
- B. Air Saver Units with WP prefix are suitable for most painting applications. Test before use if in direct contact with painted surface.
- C. If test in painting application fails, try cycling Air Saver Unit for 48 hours and repeat test.
- D. DO NOT use "WP" Air Saver Unit in 'clear coat' applications.
- E. Adjustable to maximum frequency of 1Hz.

Most popular.



For inventory, lead times, and kit lookup, visit www.pdnplu.com



Ordering Information ASC500-1W / ASO500-1W

Function	Fluid	Flow @ 72.5 psi	Port Size	Operating Temperature	Pressure Range, psi	Pilot air Supply, psi	Blow Type	Port Type	Part Number
Normally closed	Dry air	15.9 scfm	1/8"	23-122°F	29-72.5	Internal pilot	Pulse/continuous	NPT	ASC500-1W-90
								BSP	ASC500-1W-10
Normally open	Dry air	15.9 scfm	1/8"	23-122°F (A)	29-72.5	Internal pilot	Pulse/continuous	NPT	ASO500-1W-90
								BSP	ASO500-1W-10

Cable

Cable with specific connector (AWG26 ASC/ASO in common)

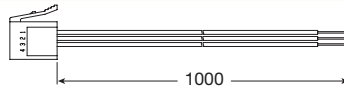

ASC-D24-CL10

Dimensions: ASC500-1W-90 / ASO500-1W-90 (NPT model)

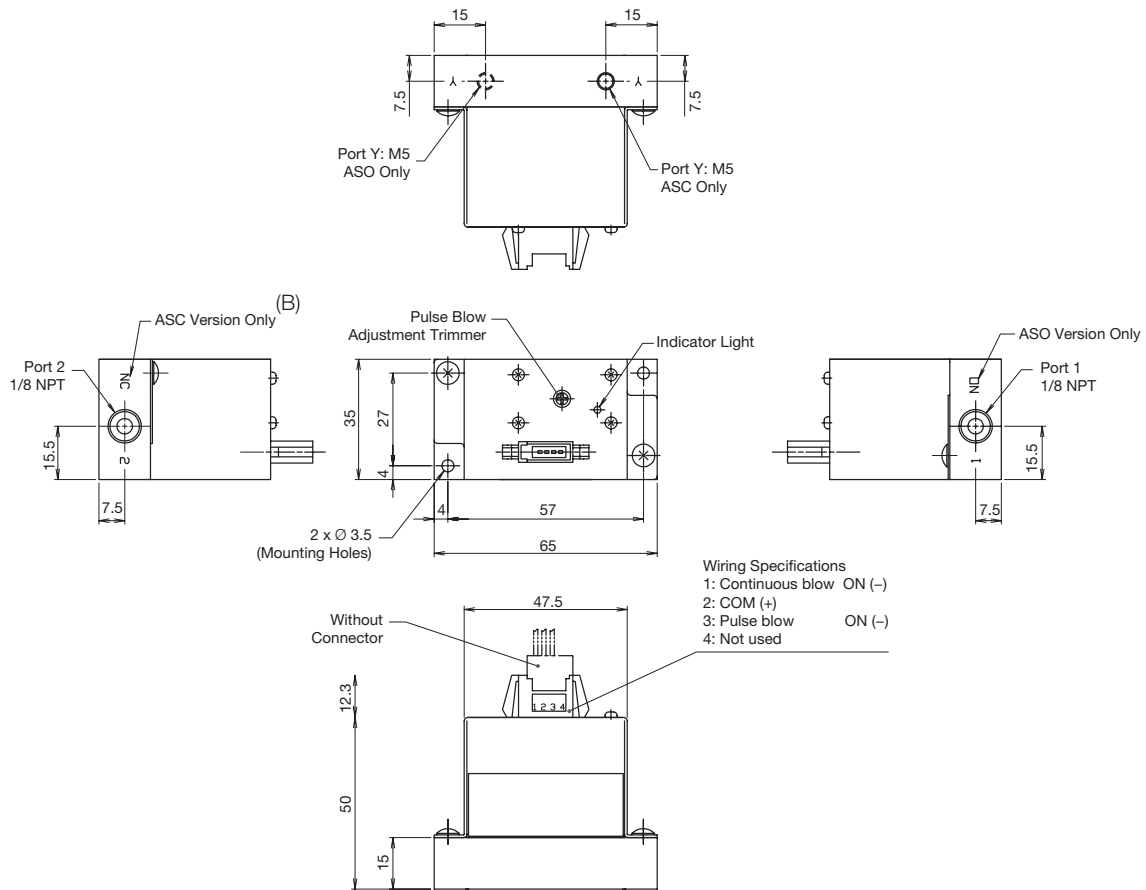

Piping

Port 1: Supply port (Compressor side)
 Port 2: Output port (Blow nozzle side)
 Y port: Pilot exhaust port*

* In order to avoid dust, it is recommended to attach an air muffler.

Notes:

- A. When temperature of valve goes below 5°C (41°F), complete dry air shall be supplied to prevent from freezing.
- B. Adjustable to maximum frequency of 22Hz.

Most popular.



For inventory, lead times, and kit lookup, visit www.pdnplu.com

C80

Parker Hannifin Corporation
 Pneumatic Division
 Richland, Michigan
www.parker.com/pneumatics

Features

N Series

For decades Parker Pneumatics and Heavy Industrial have been synonymous with durability and long life. High flow-speed N Series poppet valves have been operating in foundries, steel mills, and automotive casting & stamping plants without fail.

Features

- Continuous duty rated option
- Non-lube service
- Hi-flow, short stroke poppet
- Indicator lights available

Specifications

- 2-way NC
- 3-way NO & NC
- Selector function

Ports

- 3/8" Body – 3/8", 1/2" NPT; 3.0 to 4.4 Cv
- 3/4" Body – 3/4", 1" NPT; 9.0 to 11.0 Cv
- 1-1/4" Body – 1", 1-1/2" NPT; 20.0 to 30.0 Cv
- BSPP "G" threads available

Certification / approval

- Approved to be CE marked (Standard L-Pilot & P-Pilot)
- NEMA 4 Option
- Hazardous Duty Option IP65 Rating / NEMA 4

Material specifications

Valve body	Cast aluminum
Poppet assembly	Aluminum and stainless steel
Pilot Valve	Zinc, stainless steel, brass, copper, zinc plated steel
Seals	Nitrile

Lubrication

The high speed poppet valves are pre-lubricated to permit use with non-lubricated air. However, air should be lubricated to assure maximum seal life.

F442 lubricating oil is recommended. This oil is specially formulated to provide peak performance and maximum service life from air-operated equipment.

Installation

CAUTION: DO NOT RESTRICT THE INLET TO POPPET VALVES

Restriction of the inlet can starve the air supply to the pilot section of internally piloted poppet valves and result in slow shifting or failure of the valve to shift properly. Always connect the supply line directly to the inlet of the valve using the full pipe size of the valve inlet. Never use a quick coupling to connect a poppet valve to the air supply. On valves with a small inlet port, use of an upstream surge tank may be required at lower operating pressures to insure an adequate air supply and proper operation.

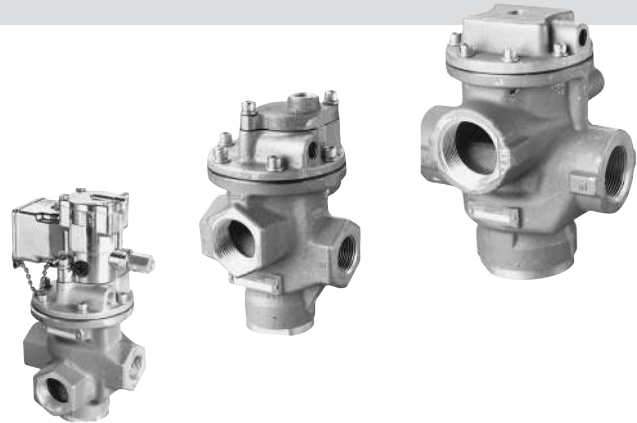

Operating information

Operating pressure:

Solenoid valves - internal pilot supply

3/8" Basic	3/4" Basic	1-1/4" Basic
20 to 140 PSIG (standard)	25 to 140 PSIG (200 PSIG option available)	25 to 140 PSIG (200 PSIG option available)

Solenoid valves - external pilot supply

Air pressure thru valve (PSI)	External pilot pressure required (PSI) *	
	3/8" Basic	3/4" Basic
25 PSI	35-200	35-200
50 PSI	45-200	40-200
75 PSI	55-200	50-200
100 PSI	65-200	65-200

Vacuum up to 1" HG, less than a perfect vacuum.

* With 200 PSI option. Do not exceed 140 PSI with standard pilots.

Internal pilot - remote pilot valve

Air pressure thru valve (PSI)	Remote pilot pressure (PSI)		
	3/8" Basic	3/4" Basic	1-1/4" Basic
25 PSI	30-250	30-250	30-250
50 PSI	50-250	50-250	50-250
75 PSI	70-250	75-250	70-250
100 PSI	95-250	95-250	90-250
150 PSI	140-250	145-250	130-250
200 PSI	175-250	185-250	175-250
250 PSI	215-250	230-250	205-250

Operating temperature:

Operator type	Duty cycle *	Minimum ambient temperature	Maximum ambient temperature
Standard service	Intermittent	0°F (-18°C)	125°F (52°C)
Solenoid	Continuous	0°F (-18°C)	100°F (38°C)
Special service	Intermittent	0°F (-18°C)	125°F (52°C)
Solenoid	Continuous	0°F (-18°C)	125°F (52°C)
Remote pilot	Not applicable	0°F (-18°C)	200°F (93°C)

* Applications with pilot valves energized for ten (10) minutes or longer with a duty cycle greater than 70% are considered to be continuously energized.

$$\text{Duty cycle} = \frac{\text{Time energized}}{\text{Time energized} + \text{time off}} \times 100\% = \% \text{ Duty Cycle}$$



Inline Valves

Viking Lite

Viking Extreme

B3, B5, B6 Series

B7, B8 Series

Air Saver Unit

"N" Series



For inventory, lead times, and kit lookup, visit www.pdnplu.com

Common Part Numbers

Single Solenoid, Non-locking manual override, internal "L" pilot 140 PSI, standard service, junction box w/ light.



Body Size	Cv	In / cyl Ports	Exhaust Port	Voltage	2-way, 2-position normally closed	3-way, 2-position normally closed	3-way, 2-position normally open
3/8"	3.6 to 3.9	3/8"	1/2"	120VAC	N3153904553	N3553904553	N3753904553
				24VDC	N3153904549	N3553904549	N3753904549
		1/2"	1/2"	120VAC	N3154904553	N3554904553	N3754904553
				24VDC	N3154904549	N3554904549	N3754904549
3/4"	7.7 to 9.6	3/4"	1"	120VAC	N3156904553	N3556904553	N3756904553
				24VDC	N3156904549	N3556904549	N3756904549
		1"	1"	120VAC	N3157904553	N3557904553	N3757904553
				24VDC	N3157904549	N3557904549	N3757904549

Normally Closed Normally Open

Single Solenoid, Non-locking manual override, internal "L" pilot 140 PSI, standard service, junction box w/ light, 4-pin M12.



Normally Closed

Body Size	Cv	In / cyl Ports	Exhaust Port	Voltage	2-way, 2-position normally closed	3-way, 2-position normally closed	3-way, 2-position normally open
3/8"	3.6 to 3.9	3/8"	1/2"	24VDC	N3153J04579F	N3553J04579F	N3753J04579F
		1/2"	1/2"	24VDC	N3154J04579F	N3554J04579F	N3754J04579F
3/4"	7.7 to 9.6	3/4"	1"	24VDC	N3156J04579F	N3556J04579F	N3756J04579F
		1"	1"	24VDC	N3157J04579F	N3557J04579F	N3757J04579F

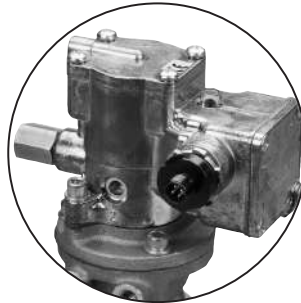

4-Pin Male/Single Solenoid
(Encl. Option J, Wiring Option F)
(Per ISO 202/01)

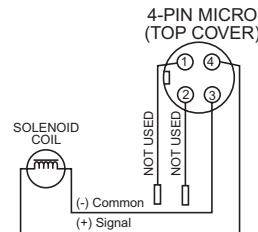

C
 Inline Valves
 Viking Lite
 Viking Extreme
 B3, B5, B6 Series
 B7, B8 Series
 Air-Saver Unit
 "N" Series

 Most popular.



For inventory, lead times, and kit lookup, visit www.pdnplu.com

"N" Series 3/8", 3/4" & 1-1/4" Body Sizes - Solenoid 'L' Pilot

N 315 3 9 0 45 53

Valve Function - Solenoid	
3/8" & 3/4" Body	
2-Way, Normally Closed	315
3-Way, Normally Closed	355
3-Way, Normally Open	375
1-1/4" Body	
2-Way, Normally Closed	325
3-Way, Normally Closed	365
3-Way, Normally Open	385

"L" Pilot Configuration	
Blank	None
C	Chrysler Wiring - Enclosure 'J' & 'N'
F	Ford Wiring - Enclosure 'E', 'J' & 'N'
G	GM Wiring - Enclosure 'J' & 'N'

Port Size / Thread Type	
3/8" Body Size	
3/8" Inlet & Cyl - 1/2" Exhaust - NPT	3
1/2" Inlet & Cyl - 1/2" Exhaust - NPT	4
1/2" Inlet & Cyl - 1/2" Exhaust - BSPP	N
3/4" Body Size	
3/4" Inlet & Cyl - 1" Exhaust - NPT	6
3/4" Inlet & Cyl - 1" Exhaust - BSPP	Q *
1" Inlet & Cyl - 1" Exhaust - NPT	7
1-1/4" Body Size	
1" Inlet & Cyl - 1 1/4" Exhaust - NPT	7
1-1/4" Inlet & Cyl - 1-1/2" Exhaust - NPT	8
1-1/2" Inlet & Cyl - 1-1/2" Exhaust - NPT	9
1-1/2" Inlet & Cyl - 1-1/2" Exhaust - BSPP	T *

"L" Pilot Code						
Code	Voltage			Solenoid Enclosure Options		
	AC 60hz	AC 50hz	DC	Standard Duty (01, 45)	Cont. Duty (04, 48)	200 PSI (46)
42	24	24	6	5, 6	6	
45			12	1, 5, 6		
49			24	1, 2, 3, 5, 6, 8, 9, W	6, 8, 9	9
51			48	1		
53	120	110		1, 2, 3, 5, 6, 8, 9, E, N, W	1, 6, 8, 9, N	8, 9, E
57	240	220		1, 3, W		
61			120	5, 6		
79			24	E, J	E, J	E, J

"L" Pilot Configuration	
01 *	External Pilot, Std Service, 140 PSI
04 *	External Pilot, Cont Duty, 140 PSI
45	Internal Pilot, Std Service, 140 PSI
46	Internal Pilot, Std Service, 200 PSI
48	Internal Pilot, Cont Duty, 140 PSI

* Not available with valve function 325.

** Available Solenoid Enclosure J only.

Note: BSPP is to the ISO 228 standard, and requires an R-BSPT male fitting.

* Not available with valve function 325, 365, and 385 (1-1/4" body).

Solenoid Enclosure / Override	
Basic Pilot	1
Basic Pilot NLMO	2
Basic Pilot LMO	3
Junction Box NLMO	5
Junction Box LMO	6
Junction Box NLMO w/ Light	8
Junction Box LMO w/ Light	9
Basic Pilot ext. LMO	W
JIC NLMO w/ Light - 3-Pin Automotive	E
JIC NLMO w/ Light - 4-Pin M12	J
JIC NLMO w/ Light - 5-Pin Automotive	N

Solenoid Type	
0	Standard
5 *	Hazardous Duty
8 *	NEMA 4 Solenoid

* Available with enclosure 2 & 3, 'L', pilot configuration 04 & 48, and voltage 49 & 53 ONLY.

Continuous Duty Pilots

Continuous duty pilots are designed for applications where cycling is infrequent and the pilot is to be energized for indefinite periods of time . . . hours, days or weeks. Typical uses include fail-safe or emergency shutdown circuits where the pilot is to be energized and the valve open as long as the main control is "live" in order to shut off air to equipment in the event of power failure.

The Continuous duty pilot operates satisfactorily in ambient temperatures up to 125°F, even when continuously energized and without the benefit of the cooling air which normally flows through the pilot during frequent cycling. Under certain conditions,

satisfactory operation may be obtained at ambient temperatures above 125°F. CONSULT FACTORY.

Incorporating the performance-proven design features of the standard L-Pilot, the continuous duty pilot utilizes a bullet-shaped stem on the upper end of the plunger. This bullet-shaped stem, seating in a high-temperature rubber o-ring, provides both a bubble-tight seal and positive release.

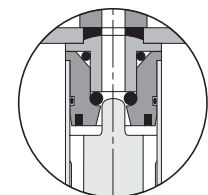

Continuous Duty Pilot

 Most popular.



For inventory, lead times, and kit lookup, visit www.pdnplu.com

C83

Parker Hannifin Corporation
Pneumatic Division
Richland, Michigan
www.parker.com/pneumatics

C

Inline Valves

Viking Lite

Viking Extreme

B3, B5, B6 Series

B7, B8 Series

Air Saver Unit

"N" Series

Ordering Information

Single Solenoid, Non-locking manual override, internal "P" pilot 125 PSI, standard service, P-pilot junction box w/ light.



Normally Closed Normally Open

Body size	Cv	In / cyl ports	Exhaust port	Voltage	2-way, 2-position normally closed	3-way, 2-position normally closed	3-way, 2-position normally open
		1"	1-1/4"	120VAC	N3257904753	N3657904753	N3857904753
1-1/4"	19.5 to 26.7	1-1/4"	1-1/2"	120VAC	N3258904753	N3658904753	N3858904753
		1-1/2"	1-1/2"	120VAC	N3259904753	N3659904753	N3859904753

"N" Series 1-1/4" Body Sizes - Solenoid Hi-Flow 'P' Pilot

N 365 8 9 0 47 53

Valve Function - Solenoid	
1-1/4" Body	
2-Way, Normally Closed	325
3-Way, Normally Closed	365
3-Way, Normally Open	385

Port Size / Thread Type	
1-1/4" Body Size	
1" Inlet & Cyl - 1 1/4" Exhaust - NPT	7
1-1/4" Inlet & Cyl - 1-1/2" Exhaust - NPT	8
1-1/2" Inlet & Cyl - 1-1/2" Exhaust - NPT	9
1-1/2" Inlet & Cyl - 1-1/2" Exhaust - BSPP	T

Note: BSPP is to the ISO 228 standard, and requires an R-BSPT male fitting.

"P" Pilot Code				
Code	Voltage			Enclosure Options
	AC 60hz	AC 50hz	DC	
49			24	5, 6
53	120	110		5, 6, 8, 9

"P" Pilot Configuration	
02	External Pilot, Std Service, 125 PSI
47	Internal Pilot, Std Service, 125 PSI

Solenoid Type	
0	Standard

Solenoid Enclosure / Override	
5	Junction Box NLMO
6	Junction Box LMO
8	Junction Box NLMO w/ Light
9	Junction Box LMO w/ Light

- C
- Inline Valves
- Viking Lite
- Viking Extreme
- B3, B5, B6 Series
- B7, B8 Series
- Air-Saver Unit
- "N" Series

 Most popular.



For inventory, lead times, and kit lookup, visit www.pdnplu.com

Ordering Information

Remote Pilot

Single Remote Pilot, 1/4" NPT remote pilot port with internal pilot return.

Body size	Cv	In / cyl ports	Exhaust port	2-way, 2-position normally closed	3-way, 2-position normally closed	3-way, 2-position normally open
3/8"	3.6 to 3.9	3/8"	1/2"	N31431091	N35431091	N37431091
		1/2"	1/2"	N31441091	N35441091	N37441091
3/4"	7.7 to 9.6	3/4"	1"	N31461091	N35461091	N37461091
		1"	1"	N31471091	N35471091	N37471091



Normally Closed Normally Open

Single Remote Pilot, 1/4" NPT remote pilot port with internal pilot return.

Body size	Cv	In / cyl ports	Exhaust port	2-way, 2-position normally closed	3-way, 2-position normally closed	3-way, 2-position normally open
1-1/4"	19.5 to 26.7	1"	1-1/4"	N32471091	N36471091	N38471091
		1-1/4"	1-1/2"	N32481091	N36481091	N38481091
		1-1/2"	1-1/2"	N32491091	N36491091	N38491091



Normally Closed Normally Open

"N" Series 3/8", 3/4" & 1-1/4" Body Sizes - Remote Pilot



Valve Function - Solenoid	
3/8" & 3/4" Body	
2-Way, Normally Closed	314
3-Way, Normally Closed	354
3-Way, Normally Open	374
1-1/4" Body	
2-Way, Normally Closed	324
3-Way, Normally Closed	364
3-Way, Normally Open	384

Port Size / Thread Type	
3/8" Body Size	
3/8" Inlet & Cyl - 1/2" Exhaust - NPT	3
1/2" Inlet & Cyl - 1/2" Exhaust - NPT	4
1/2" Inlet & Cyl - 1/2" Exhaust - BSPP	N
3/4" Body Size	
1/2" Inlet & Cyl - 3/4" Exhaust - BSPP	P
3/4" Inlet & Cyl - 1" Exhaust - NPT	6
3/4" Inlet & Cyl - 1" Exhaust - BSPP	Q
1" Inlet & Cyl - 1" Exhaust - NPT	7
1-1/4" Body Size	
1" Inlet & Cyl - 1 1/4" Exhaust - NPT	7
1-1/4" Inlet & Cyl - 1-1/2" Exhaust - NPT	8
1-1/2" Inlet & Cyl - 1-1/2" Exhaust - NPT	9
1-1/2" Inlet & Cyl - 1-1/2" Exhaust - BSPP	T*

Pilot Configuration	
089 *†	External Pilot Return
091	Internal Pilot Return

* Not available with 1-1/4" body size with Port Size option T
 † Not available with 3/8" body size with Port Size option 3

Note: BSPP is to the ISO 228 Standard, and requires an R-BSPT male fitting.

Most popular.



For inventory, lead times, and kit lookup, visit www.pdnplu.com

Replacement Pilots



Description	Standard L-Pilot		Continuous Duty L-Pilot	
	Locking	Non-locking	Locking	Non-locking
Override Type	Locking	Non-locking	Locking	Non-locking
Basic with override	K0653035**	K0652035**	K0853025**	K0852025**
JIC with junction box & override	K0656035**	K0655035**	K0856025**	K0855025**
JIC pilot with junction box & override & indicator lights (120VAC only)	K0659035**	K0658035**	K0859025**	K0858025**

** Voltage code - (reference model index for availability)

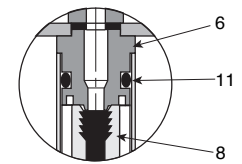
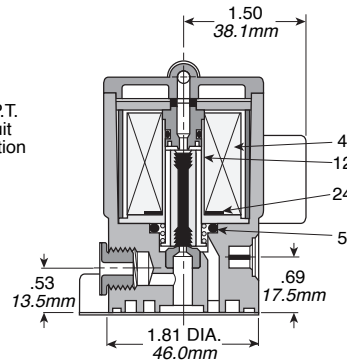
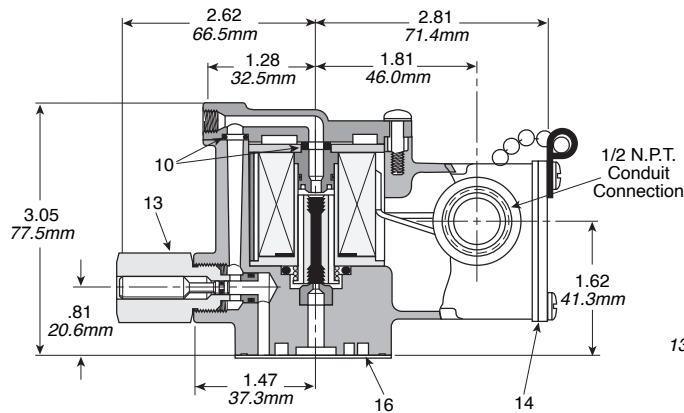

Standard Duty Pilot Only

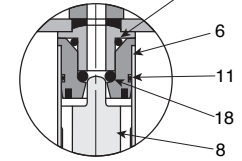

Continuous Duty Pilot Only

Parts List

Item no.	Part Number	Description
4	K593025	Coil 120V 60Hz / 110V 50Hz
	K593035	Coil 240V 60Hz / 220V 50Hz
	K593003	Coil 6VDC / 24V 60Hz
	K593010	Coil 12VDC
	K593014	Coil 24VDC
5	K593041	Coil 120VDC
	H14213	Seal
6	K423006	Top Seat
	K423010	Top Seat (Continuous Duty)
8	K343002	Plunger (STD. Service)
	K343001	Plunger (Continuous Duty)
10*	H14201	Seal
11*	K41RB72011	O-Ring (STD. Service)
	H24969	O-Ring (Continuous Duty)

Item no.	Part Number	Description
12	K272004	Plunger Guide
13	K152003	Override Assembly
14	K183047	Cover Gasket
16*	K183001	Gasket
18*	H13473	O-Ring
20*	H13413	O-Ring
22	H19102	120 AC Only – Indicator Light
24	K183108	Gasket

Coil leads are 19" long.

* Parts included in Service Kit.

Continuous Duty Kit K352366

Standard Service Kit K352166

C
 Inline Valves
 Viking Lite
 Viking Extreme
 B3, B5, B6 Series
 B7, B8 Series
 Air-Saver Unit
 "N" Series



For inventory, lead times, and kit lookup, visit www.pdnplu.com

Replacement Pilots



Description	Hazardous Duty L-Pilot		NEMA 4 L-Pilot	
	Hazardous duty L-pilot - UL & CSA	K0451025**	N/A	
Override Type	Locking	Non-Locking	Locking	Non-Locking
Hazardous duty with override	K0453025**	K0452025**		
NEMA 4 with override			K2553025**	K255202549

** Voltage code - 49 & 53

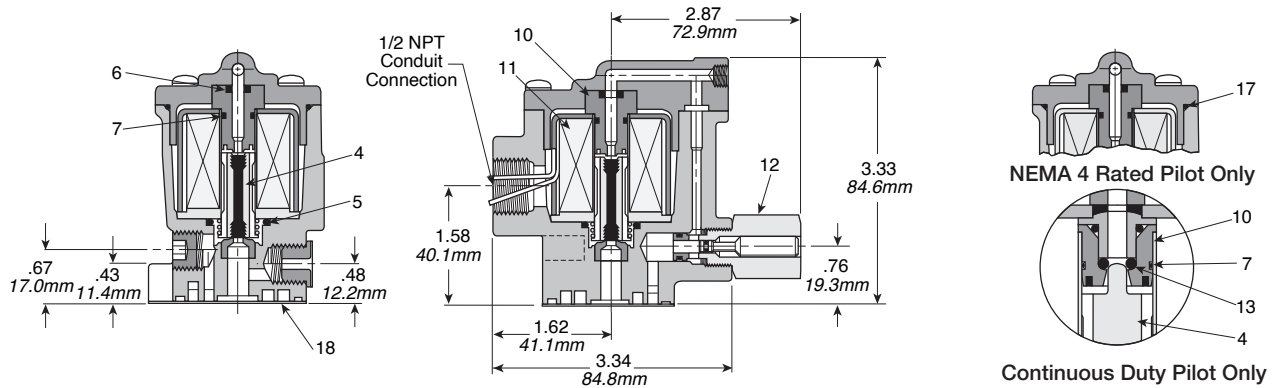

Parts List

Item no.	Part Number	Description
4*	K343002	Plunger (STD. Service)
	K343001	Plunger (Continuous Duty)
5*	K14213	Seal
6*	K41RB72009	O-Ring
	K41RB72008	O-Ring (STD. Service)
7*	K41RB72011	O-Ring (STD. Service)
	H24969	O-Ring (Continuous Duty)
10	K423001	Top Seat
	K423002	Top Seat (Continuous Duty)
11	K593025	Coil 120V 60Hz / 110V 50Hz
	K593035	Coil 240V 60Hz / 220V 50Hz
	K593003	Coil 6VDC / 24V 60Hz
	K593010	Coil 12VDC
	K593014	Coil 24VDC
	K593041	Coil 120VDC

Item no.	Part Number	Description
12	K152003	Override Assembly
13*	H13473	O-Ring
17*	H13716	Gasket (NEMA 4 Rated Pilot Only)
18*	K183001	Gasket

Coil leads are 19" long.
 * Parts included in Service Kit.
 Continuous Duty Kit **K352366**
 Standard Service Kit **K352166**

C

Inline Valves

Viking Lite

Viking Extreme

B3, B5, B6 Series

B7, B8 Series

Air Saver Unit

"N" Series



For inventory, lead times, and kit lookup, visit www.pdnplu.com

Replacement Pilots



Description	Heavy Duty P-Pilot		
	No Override	Non-Locking	Locking
Override Type			
Basic with override	K1351045**	N/A	N/A
JIC with junction box & override	N/A	K1355045**	K1356045**
JIC Pilot with junction box & override & indicator lights (120VAC only)	N/A	K135804553	K135904553

** Voltage code - 49 & 53

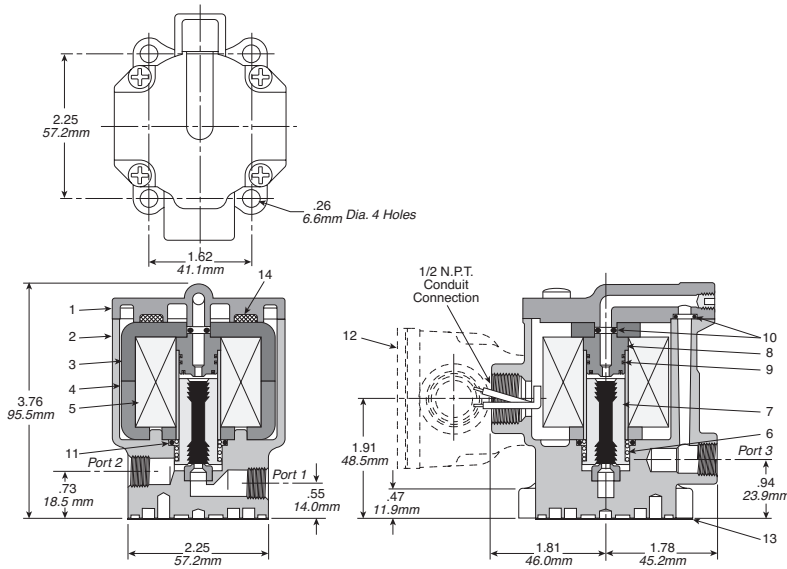

Parts List

Item no.	Part Number	Description	Item no.	Part Number	Description
1	K062005	Cover Assy	6	K473010	Spring N.O. Valve
2	K112045	Body, Man. Mtd. (1/8" Bottom Seal)		K473011	Spring N.C. Valve
3	K112046	Body, Man. Mtd. (3/16" Bottom Seal)	7 •	K343042	Plunger
4	K013001	Magnet Bar	8	K423020	Top Seat (1/8" Orifice)
	K272002	Sleeve Sub Assy		K423022	Top Seat (3/16" Orifice)
5*	K593108	Coil (115V 60Hz)	9 •	H13436	Seal
	K593112	Coil (230V 60Hz)	10 •	H14202	Seal
	K593097	Coil 24VDC	11 •	H14215	Seal
	K593107	Coil 115VDC	12	K322004	Junction Box Kit
			13 •	K183012	Gasket

* Coil leads are 19" long.
 • Parts included in Seal Kit K352064.

C
 Inline Valves
 Viking Lite
 Viking Extreme
 B3, B5, B6 Series
 B7, B8 Series
 Air-Saver Unit
 "N" Series



For inventory, lead times, and kit lookup, visit www.pdnplu.com

Coils for Pilot Operated Valves

The voltage code of the valve can be identified in the 10th and 11th digit of the valve part number.

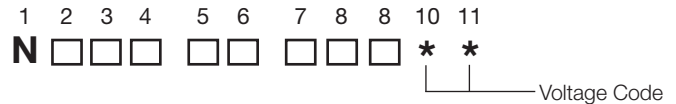

L-Pilot Valves

Voltage Code **	Voltage			Coil	
	60Hz	50Hz	DC	19" Leads	72" Leads
40	12	—	—	K593007	—
41,42	24	—	6	K593003	—
45*	—	—	12	K593010	—
49*	—	—	24 (Standard)	K593014	—
79	—	—	24 (Arc Suppressed)	K593271	—
51*	—	—	48	—	K593185
53*	120	110	—	K593025	—
57*	240	240	—	K593035	—
60	240	220	—	K593035	—
61	—	—	120	K593041	—

* Indicates voltages approved for solenoid operators designed for use in hazardous locations.

P-Pilot Valves

Voltage Code **	Voltage			Coil	
	60Hz	50Hz	DC	19" Leads	72" Leads
43	—	24	—	K593098	—
45	—	—	12	K593094	—
49	—	—	24	K593097	—
51	—	—	48	—	K593254
53	115	—	—	K593108	—
58	—	230	—	K593111	—

Solenoid Characteristics Chart

Voltage Range +10/-15% of Nominal

3/8" & 3/4" Basic – L-Pilot

Voltage/ Cycles	Amps Inrush	Amps Holding	Resistance		Insulation Class
			Ohms	Watts	
120/60VAC	.29	.18	122	12	B
110/50VAC	.21	.14	122	12	B
240/60VAC	.18	.12	610	12	B
24/50VAC	1.2	.75	6.4	9.5	B
6VDC	—	1.4	4.5	7.6	B
12VDC	—	.66	17.7	9	B
24VDC	—	.32	71	9	B
48VDC	—	.22	216	11	B

NOTE: Continuous duty type service is for applications where pilot valve is energized more than ten (10) minutes.

Solenoid Characteristics Chart

Voltage Range +10/-15% of Nominal

1-1/4" Basic – P-Pilot

Voltage/ Cycles	Amps Inrush	Amps Holding	Resistance		Insulation Class
			Ohms	Watts	
120/60VAC	.46	.25	35	18.5	B
110/50VAC	.36	.19	48	12	B
230/60VAC	.26	.15	125	19.5	B
220/50VAC	.20	.11	191	15	B
24/60VAC	2.3	1.4	1.3	20	B
24/50VAC	1.6	.9	2.1	12	B
12VDC	—	.7	17	8	B
24VDC	—	.33	68	8	B
48VDC	—	.16	275	7.5	B

NOTE: Continuous duty type service is for applications where pilot valve is energized more than ten (10) minutes.

Hazardous Duty Solenoid Listing

Valves with solenoid operators designed for hazardous locations are UL & CSA Approved as follows:

National Electric Code	Ambient Conditions	NEMA Classification
Class I Div. 1, Group C	Ethyl, Ether, Etc. Gases & Vapors	VII (7)
Class I Div. 1, Group D	Gasoline, Etc. Gases & Vapors	VII (7)
Class I Div. 2, Group B	Butadiene, Etc., Liquid, Fluid or Vapor Normally Contained, or Atmosphere Ventilated	VII (7)
Class II Div. 1, Group E	Metal Dust	IX (9)
Class II Div. 1, Group F	Coal, Coke, Carbon Black Dust	IX (9)
Class II Div. 1, Group G	Flour, Starch, Grain Dust	IX (9)

See Article 500 – Hazardous (Classified) Locations, National Electric Code.

C

Inline Valves

Viking Lite

Viking Extreme

B3, B5, B6 Series

B7, B8 Series

Air Saver Unit

"N" Series



For inventory, lead times, and kit lookup, visit www.pdnplu.com

Flow

Basic Valve Size	Inlet Port Size	Exhaust Port Size	Cv Inlet to Cylinder	Cv Cylinder to Exhaust
3/8" 3-Way, Normally Closed	3/8" Pipe	1/2" Pipe	3.6	4.2
	1/2" Pipe	1/2" Pipe	3.8	4.3
3/8" 3-Way, Normally Open	3/8" Pipe	1/2" Pipe	3.6	4.1
	1/2" Pipe	1/2" Pipe	3.9	4.5
3/4" 3-Way, Normally Closed	1/2" Pipe	3/4" Pipe	8.2	9.2
	3/4" Pipe	1" Pipe	9.3	10.8
3/4" 3-Way, Normally Open	1/2" Pipe	3/4" Pipe	7.7	6.6
	3/4" Pipe	1" Pipe	9.6	11.4
1-1/4" 3-Way, Normally Closed	1" Pipe	1-1/4" Pipe	19.5	23.5
	1-1/4" Pipe	1-1/2" Pipe	23.3	26.9
	1-1/2" Pipe	1-1/2" Pipe	23.3	26.9
1-1/4" 3-Way, Normally Open	1" Pipe	1-1/4" Pipe	20.4	24.8
	1-1/4" Pipe	1-1/2" Pipe	25.0	29.1
	1-1/2" Pipe	1-1/2" Pipe	26.7	29.9

Wiring Connections

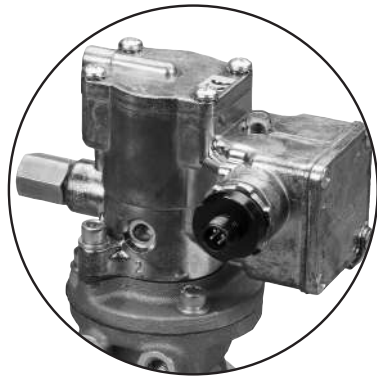

Chrysler Connection

4-Pin Male/Single Solenoid
 (Encl. Option J, Wiring Option C)

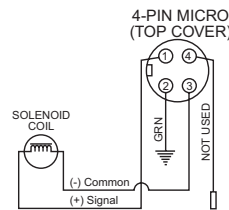

5-Pin Male/Single Solenoid
 (Encl. Option N, Wiring Option C)

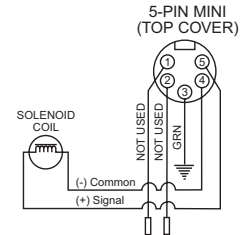

Ford Connection

3-Pin Male/Single Solenoid
 (Encl. Option E, Wiring Option F)

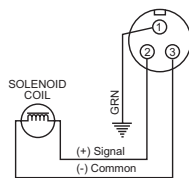

4-Pin Male/Single Solenoid
 (Encl. Option J, Wiring Option F)
 (Per ISO 202/01)

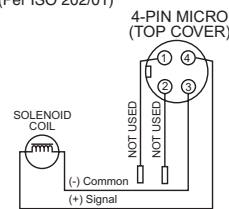

5-Pin Male/Single Solenoid
 (Encl. Option N, Wiring Option F)

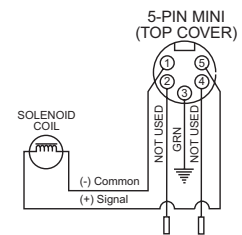

Automotive Connections

- 3-Pin & 5-Pin "Mini" (7/8 UNF Thread)
- 4-Pin "Micro" (M12 Thread)

Solenoid Configurations

"E", "J", "N"

GM Connection

4-Pin Male/Single Solenoid
 (Encl. Option J, Wiring Option G)

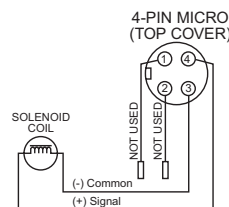

5-Pin Male/Single Solenoid
 (Encl. Option N, Wiring Option G)

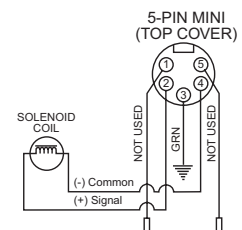

For inventory, lead times, and kit lookup, visit www.pdnplu.com

C
 Inline Valves
 Viking Lite
 Viking Extreme
 B3, B5, B6 Series
 B7, B8 Series
 Air-Saver Unit
 "N" Series

Selection

Although reasonable safety factors are designed into each speed poppet valve, it is important that application requirements do not exceed the rated limitation of the valve. This precaution insures a sufficient safety factor.

Life Expectancy

Normal multimillion cycle life expectancy of high speed poppet series valves is based on the use of properly filtered and lubricated air at room temperature. In actual laboratory tests, the high speed poppet valves provide maintenance-free service life in excess of 20,000,000 cycles.

Lubrication

The high speed poppet valves are pre-lubricated to permit use with non-lubricated air. However, air should be lubricated to assure maximum seal life.

F442 lubricating oil is recommended. This oil is specially formulated to provide peak performance and maximum service life from air-operated equipment.

Other good air line lubricating oils may be used provided they atomize readily and are of the medium aniline type. Aniline point range must be between 180°F - 220°F. Viscosity SUS @ 100°F of 140-170. High aniline oils will shrink seals; low aniline oils will swell seals, reducing operating life and expectancy.

Installation

Valves should be installed with reasonable accessibility for service whenever possible. Care should be taken to hold piping length to a minimum and to protect valves from exposure to extreme heat, dirt and moisture. Piping should be clean and clear of dirt and chips. Threads should be the correct size and undamaged. Pipe joint compound should be used sparingly and only on pipe threads, never in the valve body. Care should be taken in installation to avoid undue strain on valve.

For the small port size options, it is recommended that an air reservoir is located close to the valve inlet as to not starve the valve of air pressure.

⚠ CAUTION: DO NOT RESTRICT THE INLET TO POPPET VALVES

Restriction of the inlet can starve the air supply to the pilot section of internally piloted poppet valves and result in slow shifting or failure of the valve to shift properly. Always connect the supply line directly to the inlet of the valve using the full pipe size of the valve inlet. Never use a quick coupling to connect a poppet valve to the air supply. On valves with a small inlet port, use of an upstream surge tank may be required at lower operating pressures to insure an adequate air supply and proper operation.

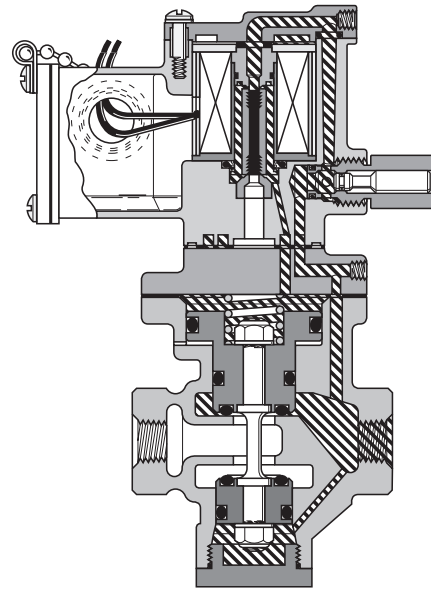

**3/8" Solenoid Pilot De-Energized
 Normally Closed**

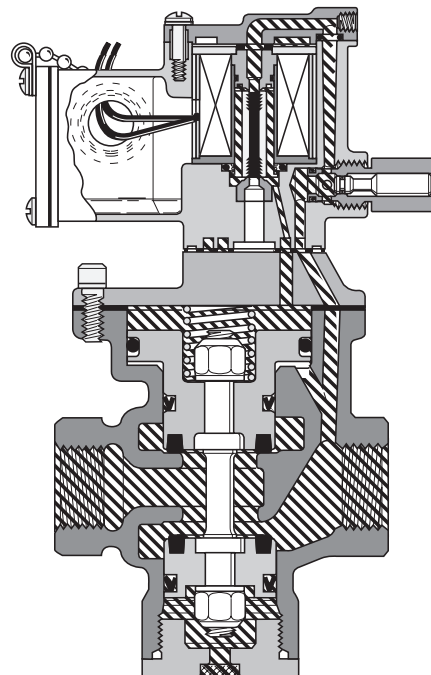

**1-1/4" Solenoid Pilot De-Energized
 Normally Open**

C	Inline Valves
Viking Lite	Viking Extreme
B3, B5, B6 Series	B7, B8 Series
Air Saver Unit	"N" Series

Dimensional Data - Single Solenoid

Internal Pilot - 3/8" & 3/4" Basic Body

Normally Closed

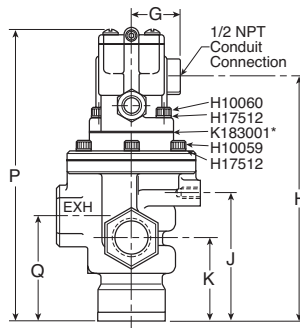
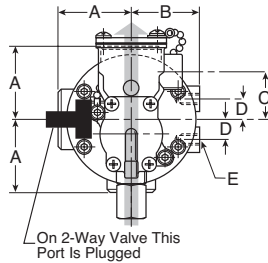
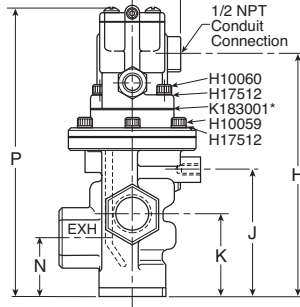
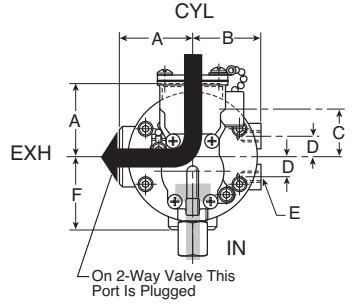
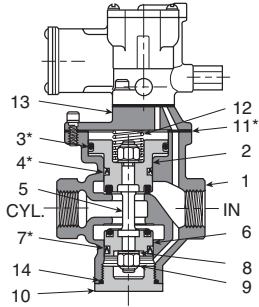

Normally Open

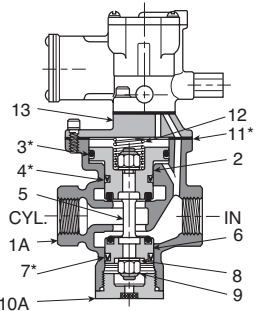

Key	3/8" Valve	3/4" Valve	Description
1	3/8" Tap K053022	1/2" Tap K053075 3/4" Tap K053076	Body (N.C.)
1A	3/8" Tap K053025	1" Tap K053220 3/4" Tap K053077 3/4" Tap K053078	Body (N.O.)
2	K212001	1" Tap K053218	Upper piston Assy
3*	H13648	H13728	Seal

Exhaust
Pressure

Top view indicates flow through 3-Way valve with coil de-energized.

NOTE: For normal valve operation, override must be in "out" position.

Internal Pilot - 3/8" & 3/4" Basic Body

Key	3/8" Body		3/4" Body	
	Inch	mm	Inch	mm
A	1.56	40	2.13	54
B	1.50	38	1.94	49
C	1.81	46	1.34	34
D	.56	14	.56	14
E	3/8-16UNC 7/16" deep		3/8-16UNC 9/16" deep	
F	1.75	44	2.25	57
G	1.50	38	1.50	38
H	5.92	150	7.14	181
J	3.19	81	3.75	95
K	1.88	47	2.44	62
N	1.44	37	1.78	45
P	7.36	196	8.58	218
Q	2.31	59	3.09	84

Service Kits

Include all parts normally required for in-service maintenance:

- 3/8" Basic valve with standard service L-Pilots.....**K352076**
- 3/8" Basic valve with continuous duty L-Pilots.....**K352276**
- 3/4" Basic valve with standard service L-Pilots.....**K352077**
- 3/4" Basic valve with continuous duty L-Pilots.....**K352277**

Key	3/8" Valve	3/4" Valve	Description
4*	H14510	H13676	U-cup (3/8), o-ring (3/4)
5	K493002	K493009	Stem
6	K202001	K202002	Lower piston Assy.
7*	H14509	H13676	U-cup (3/8), o-ring (3/4)
8	H17811	H17813	Washer (2)
9	H06326	H06332	Stop nut (2)
10	K103035	K103053	Bottom cap (N.C.)
10A	K092020	K092034	Bottom cap Assy. (N.O.)
11*	K183049	K183057	Gasket
12	K473014	K473015	Spring
13	K563015	K563017	Adapter
14*	K41RB72121	K41RB72221	O-ring

* Parts included in seal kit



For inventory, lead times, and kit lookup, visit www.pdnplu.com

Dimensional Data - Single Solenoid

External Pilot - 3/8" & 3/4" Basic Body

Normally Closed

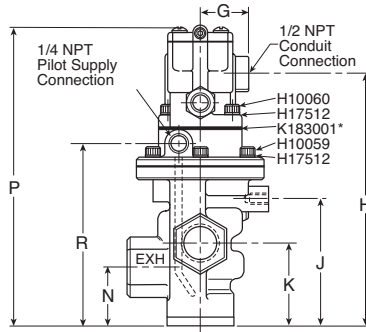
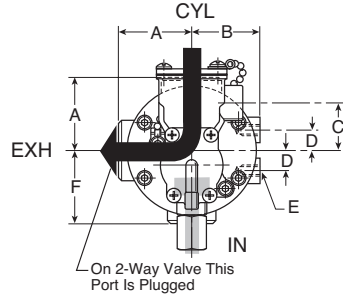
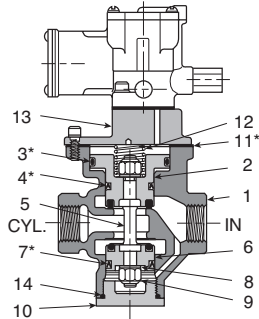

Normally Open

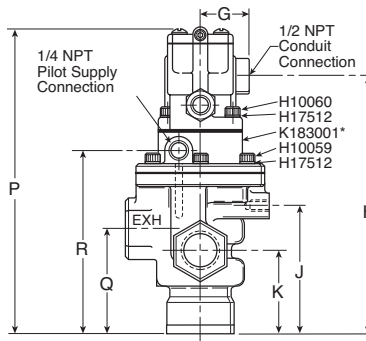
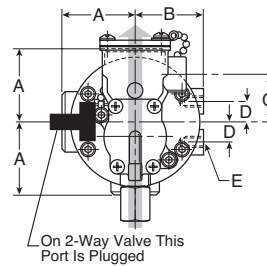
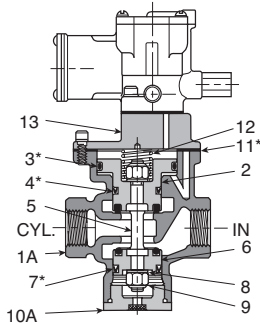

Exhaust
Pressure

Top view indicates flow through 3-Way valve with coil de-energized.

NOTE: For normal valve operation, override must be in "out" position.

External Pilot -
3/8" & 3/4" Basic Body

Key	3/8" Body		3/4" Body	
	Inch	mm	Inch	mm
A	1.56	40	2.13	54
B	1.50	38	1.94	49
C	1.81	46	1.34	34
D	.56	14	.56	14
E	3/8-16UNC 7/16" deep		3/8-16UNC 9/16" deep	
F	1.75	44	2.25	57
G	1.50	38	1.50	38
H	6.42	163	7.45	189
J	3.19	81	3.75	95
K	1.88	47	2.44	62
N	1.44	37	1.78	45
P	7.86	200	8.89	226
Q	2.31	59	3.09	84
R	4.34	110	5.38	137

Service Kits

Include all parts normally required for in-service maintenance:

- 3/8" Basic valve with standard service L-Pilots.....**K352076**
- 3/8" Basic valve with continuous duty L-Pilots.....**K352276**
- 3/4" Basic valve with standard service L-Pilots.....**K352077**
- 3/4" Basic valve with continuous duty L-Pilots.....**K352277**

Key	3/8" Valve	3/4" Valve	Description
1	—	1/2" Tap K053067	Body (N.C.)
	3/8" Tap K053019	3/4" Tap K053069	
	—	1" Tap K053221	
1A	—	3/4" Tap K053065	Body (N.O.)
	3/8" Tap K053018	3/4" Tap K053070	
	1/2" Tap K053064	1" Tap K053219	
2	K212001	K212002	Upper piston assy
3*	H13648	H13728	Seal

Key	3/8" Valve	3/4" Valve	Description
4*	K41RB72211	H13676	O-ring
5	K493002	K493009	Stem
6	K202001	K202002	Lower piston assy.
7*	K41RB72210	H13676	O-ring
8	H17811	H17813	Washer (2)
9	H06326	H06332	Stop nut (2)
10	K103035	K103053	Bottom cap (N.C.)
10A	K092020	K092034	Bottom cap assy. (N.O.)
11	K473014	K473015	Spring
12*	K183049	K183057	Gasket
13	K563016	K563021	Adapter
14*	K41RB72121	K41RB72221	O-ring

* Parts included in seal kit



For inventory, lead times, and kit lookup, visit www.pdnplu.com

Dimensional Data - Single Solenoid

Internal Pilot - 1-1/4" Basic Body

Normally Closed

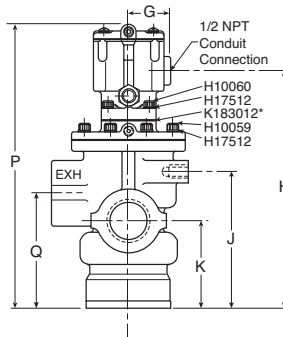
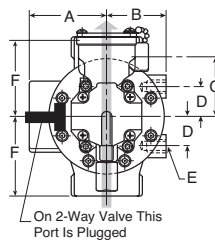
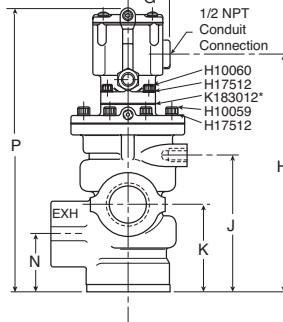
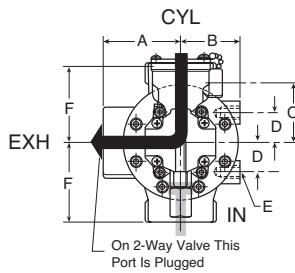
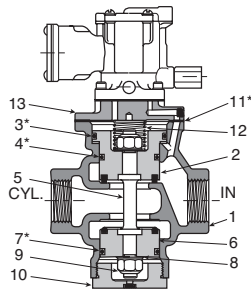

Normally Open

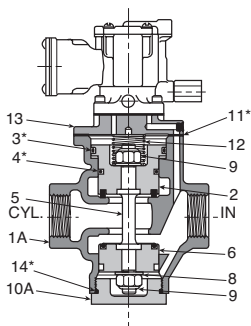

Exhaust
Pressure

Top view indicates flow through 3-Way valve with coil de-energized.

NOTE: For normal valve operation, override must be in "out" position.

Internal Pilot -
1-1/4" Basic Body

Key	1-1/4" Body	
	Inch	mm
A	3.00	76
B	2.25	57
C	1.34	34
D	1.19	30
E	1/2-13 UNC	3/4 Deep
F	3.13	80
G	1.50	38
H	9.30	236
J	5.34	136
K	3.44	87
N	2.31	59
P	11.14	283
Q	4.56	116

Service Kits

Include all parts normally required for in-service maintenance:

1-1/4" Basic valve with standard service P-Pilots **K352078**

Key	1-1/4" Valve	Description
1	1" Tap K053111	Body (N.C.)
	1-1/2" Tap K053113	
	1" Tap K053114	
1A	1-1/4" Tap K053115	Body (N.O.)
	1-1/2" Tap K053116	
	2 K313029	
3*	H13752	O-ring

Key	1-1/4" Valve	Description
4*	H13728	Seal
5	K493016	Stem
6	K313028	Lower piston
7*	H13728	Seal
8	H17817	Washer
9	H06338	Stop nut
10	K092046	Bottom cap (N.C.)
10A	K103061	Bottom cap (N.O.)
11*	K183058	Gasket
12	K473016	Spring
13	K012003	Adapter
14*	K41RB72143	O-ring

* Parts included in seal kit



For inventory, lead times, and kit lookup, visit www.pdnplu.com

Dimensional Data - Single Solenoid

Continuous Duty Pilot - 1-1/4" Basic Body

Normally Closed

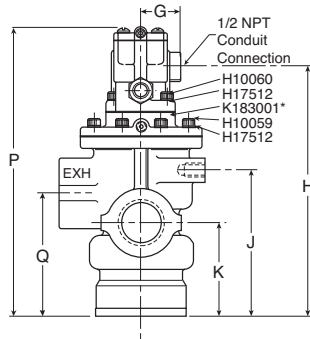
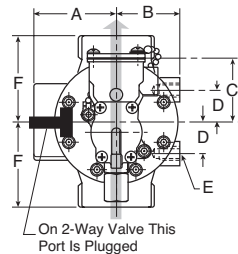
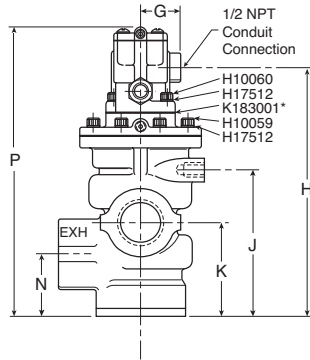
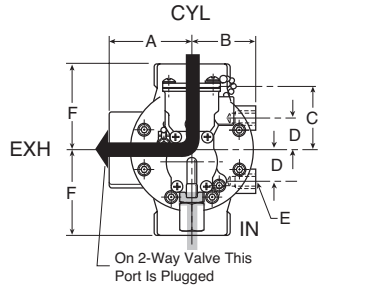
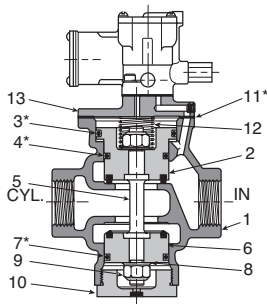

Normally Open

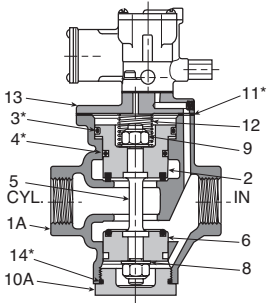

Key	1-1/4" Valve	Description
1	1" Tap K053111	Body (N.C.)
	1-1/2" Tap K053113	
	1" Tap K053114	
1A	1-1/4" Tap K053115	Body (N.O.)
	1-1/2" Tap K053116	
	2	
3*	H13752	O-Ring

Key	1-1/4" Valve	Description
4*	H13728	Seal
5	K493016	Stem
6	K313028	Lower piston
7*	H13728	Seal
8	H17817	Washer
9	H06338	Stop nut
10	K092046	Bottom cap (N.C.)
10A	K103061	Bottom cap (N.O.)
11*	K183058	Gasket
12	K473016	Spring
13	K012003	Adapter
14*	K41RB72143	O-ring

* Parts included in seal kit

Exhaust
Pressure

Top view indicates flow through 3-Way valve with coil de-energized.

NOTE: For normal valve operation, override must be in "out" position.

Continuous Duty Pilot - 1-1/4" Basic Body

Key	1-1/4" Body	
	Inch	mm
A	3.00	76
B	2.25	57
C	1.34	34
D	1.19	30
E	1/2-13 UNC	3/4 Deep
F	3.13	80
G	1.50	38
H	9.02	229
J	5.34	136
K	3.44	87
N	2.31	59
P	10.45	265
Q	4.56	116

Service Kits

Include all parts normally required for in-service maintenance:

1-1/4" Basic valve with continuous duty L-Pilot.....**K352080**



For inventory, lead times, and kit lookup, visit www.pdnplu.com

Dimensional Data - Remote Operated

Internal Return - 3/8", 3/4", 1-1/4" Basic Body

Normally Closed

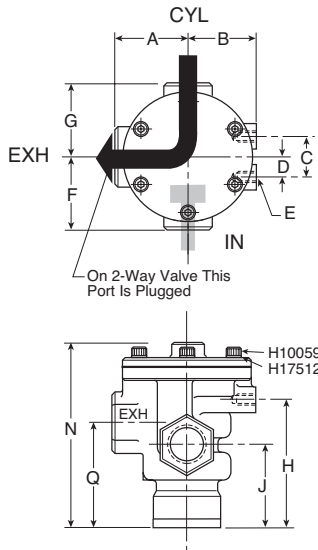
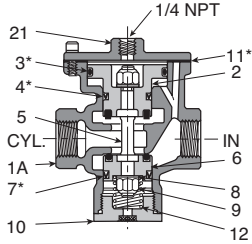

Normally Open

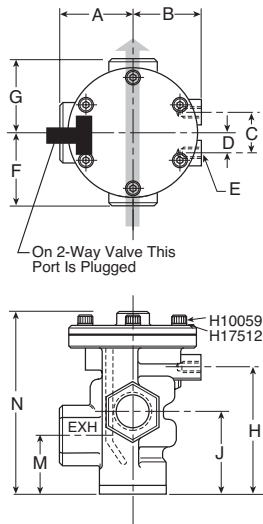
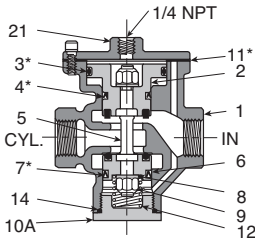

Exhaust
Pressure

Top view indicates flow through 3-Way valve.

NOTE: For normal valve operation, override must be in "out" position.

Internal Return - 3/8", 3/4", 1-1/4" Basic Body

Key	3/8" Body		3/4" Body		1-1/4" Body	
	Inch	mm	Inch	mm	Inch	mm
A	1.56	40	2.13	54	3.00	76
B	1.50	38	1.94	49	2.25	57
C	1.13	29	1.13	29	2.38	60
D	.56	14	.56	14	1.19	30
E	3/8-16UNC 7/16" deep		3/8-16UNC 9/16" deep		1/2-13UNC 3/4" deep	
F	1.75	44	2.25	57	3.13	79
G	1.56	40	2.13	54	3.13	79
H	3.19	81	3.75	95	5.34	136
J	1.88	48	2.44	62	3.44	87
M	1.44	37	1.78	45	2.66	67
N	4.22	107	5.31	135	7.19	183
Q	2.31	59	3.09	78	4.56	116

Service Kits

Include all parts normally required for in-service maintenance:

- 3/8" Basic valve.....**K352073**
- 3/4" Basic valve.....**K352074**
- 1-1/4" Basic valve**K352075**

Key	3/8" Valve	3/4" Valve	1-1/4" Valve	Description
1	—	1/2" Tap K053075	1" Tap K053111	Body (N.O.)
	3/8" Tap K053022	3/4" Tap K053076	—	
	1/2" Tap K053023	1" Tap K053220	1-1/2" Tap K053113	
1A	—	1/2" Tap K053077	1" Tap K053114	Body (N.C.)
	3/8" Tap K053025	3/4" Tap K053078	—	
	1/2" Tap K053026	1" Tap K053218	1-1/2" Tap K053116	
2	K212001	K212002	K313029	Upper piston assy
3*	H13648	H13728	H13752	Seal
4*	H14510	H13676	H13728	Seal

Key	3/8" Valve	3/4" Valve	1-1/4" Valve	Description
5	K493002	K493009	K493016	Stem
6	K202001	K202002	K313028	Lower piston assy.
7*	H13499	H13676	H13728	Seal
8	H17811	H17813	H17817	Washer (2)
9	H06326	H06332	H06338	Stop nut (2)
10	K092020	K092034	K092046	Bottom cap (N.C.)
10A	K103035	K103053	K103061	Bottom cap (N.O.)
11*	K183049	K183057	K183058	Gasket
12	K473014	K473015	K473016	Spring
14*	K41RB72121	K41RB72221	K41RB72143	O-ring
21	K123018	K123021	K123024	Cover

* Parts included in seal kit



For inventory, lead times, and kit lookup, visit www.pdnplu.com

Dimensional Data - Remote Operated

External Return - 3/8", 3/4", 1-1/4" Basic Body

Normally Closed

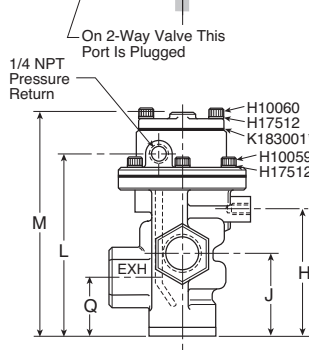
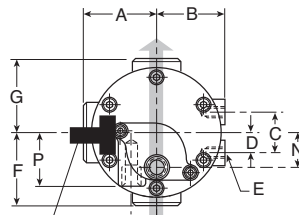
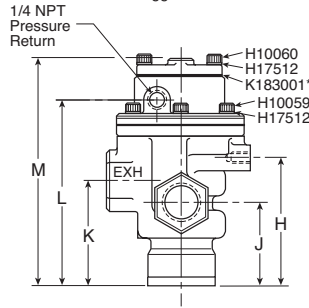
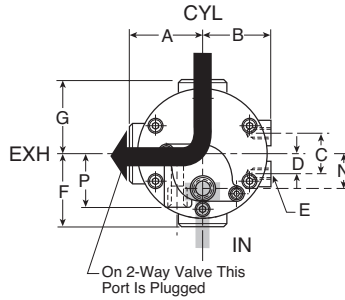
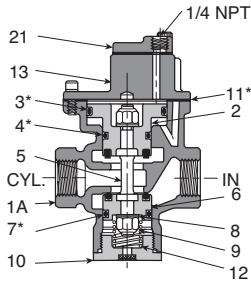

Normally Open

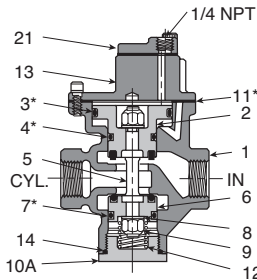

Key	3/8" Valve	3/4" Valve	1-1/4" Valve	Description
1	1/4" Tap K053011	1/2" Tap K053067	1" Tap K053143	Body (N.O.)
	—	3/4" Tap K053069	—	
	1/2" Tap K053157	1" Tap K053221	1-1/2" Tap K053146	
1A	1/4" Tap K053010	1/2" Tap K053065	1" Tap K053159	Body (N.C.)
	—	3/4" Tap K053070	—	
2	1/2" Tap K053064	1" Tap K053219	1-1/2" Tap K053145	Upper piston assy
3*	H13648	H13728	H13752	Seal
4*	H13529	H13676	H13728	Seal

Key	3/8" Valve	3/4" Valve	1-1/4" Valve	Description
5	K493002	K493009	K493016	Stem
6	K202001	K202002	K313028	Lower piston assy.
7*	H13499	H13676	H13728	Seal
8	H17811	H17813	H17817	Washer (2)
9	H06326	H06332	H06338	Stop nut (2)
10	K092020	K092034	K092046	Bottom cap assy. (N.C.)
10A	K103035	K103053	K103061	Bottom cap (N.O.)
11*	K183049	K183057	K183058	Gasket
12	K473014	K473015	K473016	Spring
13	K563016	K563021	K563027	Adapter
14*	K41RB72121	K41RB72221	K41RB72143	O-ring
21	K323027	K323027	Not used	Cover

* Parts included in seal kit

Exhaust
Pressure

Top view indicates flow through 3-Way valve.

NOTE: For normal valve operation, override must be in "out" position.

Internal Return - 3/8", 3/4", 1-1/4" Basic Body

Key	3/8" Body		3/4" Body		1-1/4" Body	
	Inch	mm	Inch	mm	Inch	mm
A	1.56	40	2.13	54	3.00	76
B	1.50	38	1.94	49	2.25	57
C	1.13	29	1.13	29	2.38	60
D	.56	14	.56	14	1.19	30
E	3/8-16UNC 7/16" deep		3/8-16UNC 9/16" deep		1/2-13UNC 3/4" deep	
F	1.75	44	2.25	57	3.13	79
G	1.56	40	2.13	54	3.13	79
H	3.19	81	3.75	95	5.34	136
J	1.88	48	2.44	62	3.44	87
K	2.31	59	3.09	78	4.56	116
L	4.34	110	5.38	137	7.31	186
M	5.31	135	6.34	161	7.88	200
N	Left of center .53 13			On center 1.00 25		
Q	1.44	37	1.78	45	2.31	59

Service Kits

Include all parts normally required for in-service maintenance:

- 3/4" Basic valve.....K352056
- 1-1/4" Basic valveK352083



For inventory, lead times, and kit lookup, visit www.pdnplu.com

Internal Return - 3/8", 3/4" & 1-1/4" Basic Body

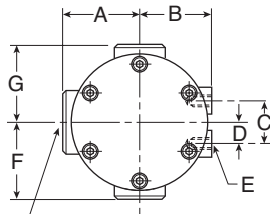

On 2-way valve this port is plugged

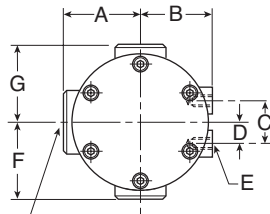

On 2-way valve this port is plugged

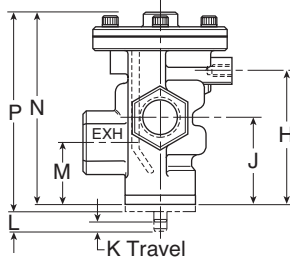
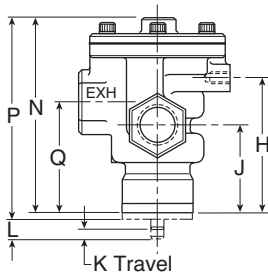

Internal Return - 3/8", 3/4" & 1-1/4" Basic Body

Key	3/8" Body		3/4" Body		1-1/4" Body	
	Inch	mm	Inch	mm	Inch	mm
A	1.56	40	2.13	54	3.00	76
B	1.50	38	1.94	49	2.25	57
C	1.13	29	1.13	29	2.38	60
D	.56	14	.56	14	1.19	30
E	3/8-16UNC 7/16" deep		3/8-16UNC 9/16" deep		1/2-13UNC 3/4" deep	
F	1.75	44	2.25	57	3.13	79
G	1.56	40	2.13	54	3.13	79
H	3.19	81	3.75	95	5.34	136
J	1.88	48	2.44	62	3.44	87
K	.50	13	.50	13	.50	13
L	.11	3	.16	4	.25	6
M	1.44	37	1.78	45	2.66	67
N	4.22	107	5.31	135	7.19	183
P	4.78	121	5.56	141	7.53	191
Q	2.31	59	3.09	78	4.56	116

External Return - 3/8", 3/4" & 1-1/4" Basic Body

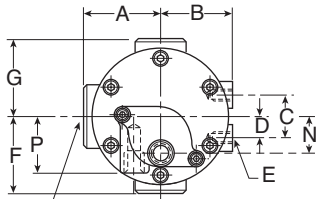

On 2-way valve this port is plugged

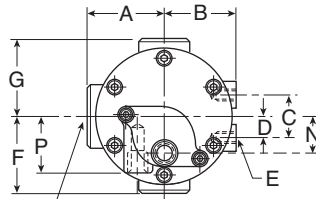

On 2-way valve this port is plugged

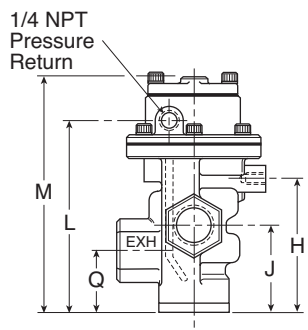
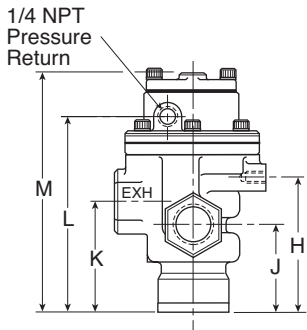

External Return - 3/8", 3/4" & 1-1/4" Basic Body

Key	3/8" Body		3/4" Body		1-1/4" Body	
	Inch	mm	Inch	mm	Inch	mm
A	1.56	40	2.13	54	3.00	76
B	1.50	38	1.94	49	2.25	57
C	1.13	29	1.13	29	2.38	60
D	.56	14	.56	14	1.19	30
E	3/8-16UNC 7/16" deep		3/8-16UNC 9/16" deep		1/2-13UNC 3/4" deep	
F	1.75	44	2.25	57	3.13	79
G	1.56	40	2.13	54	3.13	79
H	3.19	81	3.75	95	5.34	136
J	1.88	48	2.44	62	3.44	87
K	2.31	59	3.09	78	4.56	116
L	4.34	110	5.38	137	7.31	186
M	5.31	135	6.34	161	7.88	200
N	Left of center .53 13		On center 1.00 25			
Q	1.44	37	1.78	45	2.31	59

C
 Inline Valves
 Viking Lite
 Viking Extreme
 B3, B5, B6 Series
 B7, B8 Series
 Air-Saver Unit
 "N" Series



For inventory, lead times, and kit lookup, visit www.pdnplu.com



Inline Valves

Viking Lite

Viking Extreme

B3, B5, B6 Series

B7, B8 Series

Air Saver Unit

"N" Series



For inventory, lead times, and kit lookup, visit www.pdnplu.com

C99

Parker Hannifin Corporation
Pneumatic Division
Richland, Michigan
www.parker.com/pneumatics

Pneumatic Valve Products
Subbase and Manifold Valve Series

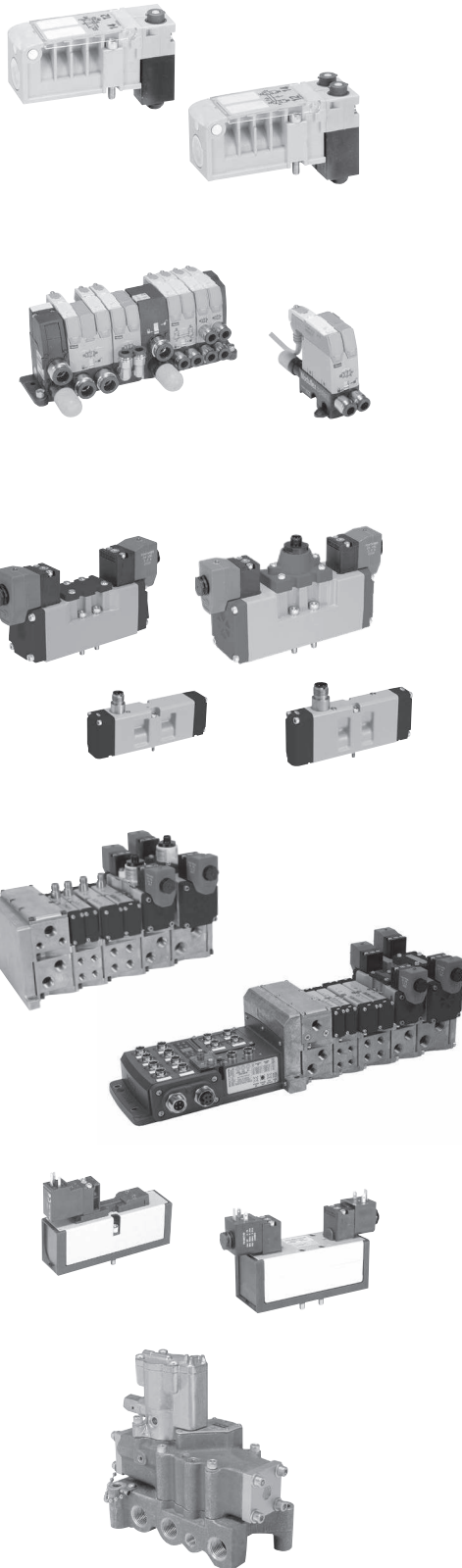

H Series Micro

Features	D2-D3
Common Part Numbers	D4-D5
Ordering Information	D6-D9
Technical / Dimensional Data	D10-D26
Accessories	D12

Moduflex Series

Features	D27-D31
Common Part Numbers / Ordering Information	D32-D46
P2M Network Nodes	D47-D54
Technical Data / Accessories	D55-D65
Dimensional Data	D66-D71

H Series ISO

Features	D72-D75
Plug-In	
15407-2 - Size 02, 01 / 5599-2, Size 1, 2	D76-D92
5599-2 - Size 3	D93-D100
Non Plug-In	
15407-1 - Size 02, 01 / 5599-1 - Size 1, 2	D101-D115
5599-1 Size 3	D116-D122
Technical Data / Accessories	D123-D137
Dimensional Data	D138-D149

Network Connectivity

Features	D150-D159
P2M Network Nodes	D160-D169
P2H Network Nodes	D170-D189
PCH Network Portal	D190-D206
Turck Network Portal	D207-D226
Accessories / Cables	D227-D229
Technical / Dimensional Data	D230

DX Series

Features	D231
Common Part Numbers / Ordering Information	D232-D238
Non Plug-In	
15407-1, Size 02 & 01	D239-D247
5599-1, Size 1, 2, 3	D248-D249
Technical Data / Accessories	D250-D262
Dimensional Data	D263-D269

Valvair II Series

Features	D270
Common Part Numbers / Ordering Information	D271-D276
Technical Data / Accessories	D277-D287
Dimensional Data	D288-D295

D

Subbase & Manual
 Valves



Features

H Series Micro

The H Series Micro Valve System incorporates a space saving back to back valve mounting design, and achieves flow rates of 0.35 Cv per valve with 4 valves having a combined width of 42mm. This plug-in valve solution simplifies wiring with the use of 25 pin connectors or fieldbus systems.

Ports

- M7 on manifolds
- 3/8 Inch on end plates

Mounting

- Manifold

Solenoids

- 24 VDC, 1.0 watt

Certification / approval

- IP65 rated
- EMC / CE Mark: According to EN 61 000-6-2



Material Specifications

Body	Polyamide reinforced fiberglass
End plates	Aluminum
Fasteners	Zinc plated steel
Manifolds	Aluminum
Spool	Brass and nitrile rubber
Spool enclosure	Brass

Operating Information

Operating pressure: Vacuum to 120 PSIG (Vacuum to 8.2 bar)
Temperature range: 5°F to 120°F (-15°C to 49°C)

2-Position & Dual 3/2

0.35 Cv
C = 1.2 NI/s x bar, b = 0.13
Qn = 282 NI/min
Qmax = 510 NI/min

3-Position

0.30 Cv
C = 1 NI/s x bar, b = 0.13
Qn = 228 NI/min
Qmax = 402 NI/min

Pilot pressure requirements:

Valve number	Minimum pilot pressure	Maximum pilot pressure
HMEVX2049A	40 PSI	120 PSI
HM2VX2049A	25 PSI	120 PSI
HM5VX2049A	45 PSI	120 PSI
HMNVX2049A	40 PSI	120 PSI
HMPVX2049A	40 PSI	120 PSI
HMQVX2049A	40 PSI	120 PSI

Wear Compensation System

- Maximum Performance
 - Low Friction
 - Lower Operating Pressures
 - Fast Response
 - Less Wear
- Long Cycle Life - Under pressure, radial expansion of the seal occurs to maintain sealing contact with the valve bore.
- Non-Lube Service - No lubrication required for continuous valve shifting.
- Bi-Directional Spool Seals - Common spool used for any pressure, including vacuum.

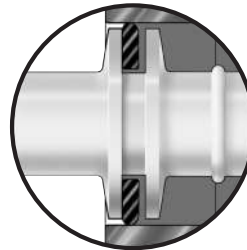

D

Subbase & Manual Valves

H Series Micro

Modulflex Series

H Series ISO

Network Connectivity

DX ISOMAX Series

Valvair II Series



For inventory, lead times, and kit lookup, visit www.pdnplu.com

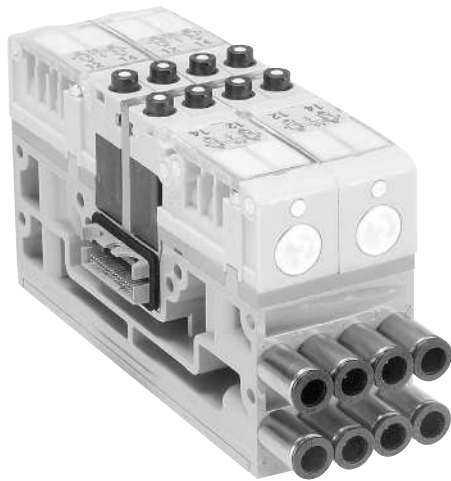

Innovative Product Design

- Back to back valve mounting design centralizes wiring in the manifold
- 4 valves on a 42mm wide manifold provides a 10.5mm wide valve solution with a reduced cost
- High flow of 0.35 Cv allows for broad application use
- Plug-in valve electronics reduce and eliminate wiring system costs
- Multiple pressure zones for many applications on the same manifold

Standard Features

- Integrated LED's identify when solenoids are active
- Side and bottom porting options on manifolds and end plates for versatile mounting
- All valve functions available for complete product offering
- Valves can be arranged in any combination for maximum flexibility
- Internal and external pilot options available for vacuum to 145 PSI applications
- IP65 protection enables direct machine mounting
- Product identification, valve function, and port description tags are standard on every manifold and are clearly visible thru a protective cover
- User configurable overrides for non-locking, locking, or no override options

Manifold Platforms

- 25 pin D-sub manifolds for control systems with discrete Outputs
- IO-Link Type A & Type B communication modules
- Cost effective moduflex fieldbus manifolds with Ethernet protocols Ethernet IP, Profinet, Ethercat and Modbus TCP

Complete Assemblies

- All products offered as component level parts for individual assembly
- Simple manifolds offer sub-assembly level products with valves and fittings attached to manifold bases in a single part number
- Add-a-fold systems offer complete assemblies; including valves, manifolds, end plates, fittings, and mufflers in as few as 2 part numbers

D

Subbase & Manual Valves

H Series Micro

Moduflex Series

H Series ISO

Network Connectivity







DX ISOMAX Series

Valvair II Series



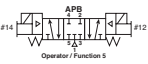

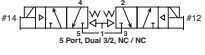
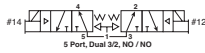
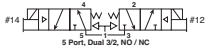

For inventory, lead times, and kit lookup, visit www.pdnplu.com

H Series Micro Valves

	Symbol	Type	Cv	Operator	Part Number
		4-way, 2-position	0.35	Single solenoid	HMEVX2049A
		4-way, 2-position	0.35	Double solenoid	HM2VX2049A
		4-way, 3-position, all ports blocked	0.3	Double solenoid	HM5VX2049A
		3-way, 2-position, dual valve, NC/NC	0.35	Double solenoid	HMNVX2049A
		3-way, 2-position, dual valve, NO/NO	0.35	Double solenoid	HMPVX2049A
		3-way, 2-position, dual valve, NO/NC	0.35	Double solenoid	HMQVX2049A
		Blanking plate	N/A	N/A	HMBVX00XXA
		Intermediate air supply	N/A	N/A	HMCVX00XXA

- All valves, except double solenoid 2-position, ship with multi functional overrides. Standard valve configuration is non-locking manual override. Each solenoid can be configured for locking override or no override with the included manual override caps.
- All valve options include an LED, which is built into the manifold.
- All valve options pull pilot pressure from the manifold. The manifold assembly can be configured for internal or external pilot on the end plate.

Manifold Bases

	Part Numbers	
		Side Port
Plug-In Valve Manifolds		
Single solenoid outputs only	 PSM21 JAP	 PSM22 JAP
Double or single solenoid outputs	 PSM21 MAP	 PSM22 MAP

Each manifold holds 4 H Series Micro Valves. Double address circuit boards contain outputs for 8 solenoids, and can be used with any valve. When a single solenoid valve is used, one address is not used but is still present on the manifold. Single address circuit boards contain outputs for 4 solenoids. Only single solenoid valves can be used.





 Most popular.

D
Subbase & Manual Valves
H Series Micro
Modulflex Series
H Series ISO
Network Connectivity
DX ISOMAX Series
Valvair II Series



For inventory, lead times, and kit lookup, visit www.pdnplu.com

Internal Pilot End Plate Kits

	Electrical Option	Porting	Side Port	Bottom Port
	25-pin, D-sub	NPT	PSML25AP	PSML26AP
		BSP	PSML21AP	PSML22AP
	Turck fieldbus with valve driver module - 16 outputs	NPT	PSMT15AP	PSMT16AP
		BSP	PSMT11AP	PSMT12AP
	Turck fieldbus with valve driver module - 32 outputs	NPT	PSMT25AP	PSMT26AP
		BSP	PSMT21AP	PSMT22AP
	Moduflex up to 24 outputs	NPT	PSMM45AP	PSMM46AP
		BSP	PSMM41AP	PSMM42AP

 Most popular.



For inventory, lead times, and kit lookup, visit www.pdnplu.com

Ordering Information

Simple Manifold Assemblies

Includes a valve manifold with 4 valves and fittings installed. End Plates must be ordered separately.

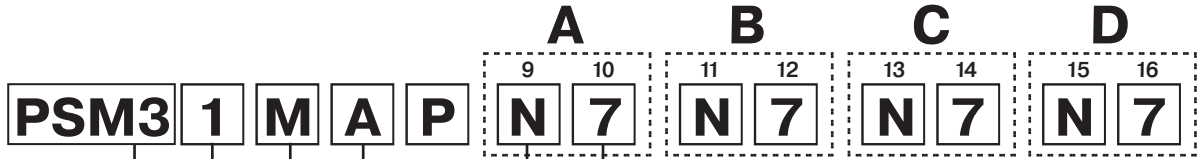

Base Style	
4-Station Manifold with Valve and / or Fitting	PSM3

Mounting Style	
Side Ported	1
Bottom Ported	2

Enclosure / Lead length	
Single Address Circuit Board	J
Double Address Circuit Board	M

Engineering Level	
Current	A

10, 12, 14, 16 Fitting	
0	Without Fitting
4	Straight Fitting for 5/32 Inch or 4mm OD Tube
6	Straight Fitting for 6mm OD Tube
7	Straight Fitting for 1/4 inch OD Tube
P	Plug for Blanking Module

9, 11, 13, 15 Valve Type	
N*	Double Solenoid, Dual 3/2, NC/NC
P*	Double Solenoid, Dual 3/2, NO/NO
Q*	Double Solenoid, Dual 3/2, 14 End NO - 12 End NC
E	Single Solenoid, 2-Position - Air Return, Spring Assist
2*	Double Solenoid, 2-Position
5*	Double Solenoid, 3-Position - APB
B**	Blanking Module
C	Intermediate Air Supply Module

* Requires double address circuit board, enclosure "M".
** Requires fitting "P".

D
 Subbase & Manual Valves
 H Series Micro
 Modulflex Series
 H Series ISO
 Network Connectivity
 DX ISOMAX Series
 Valvair II Series

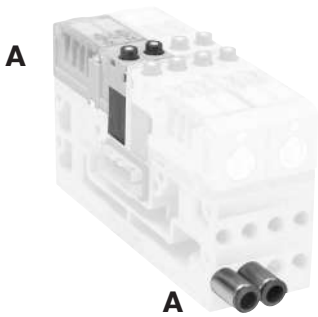

Valve Position A - Character 9
Fitting Position A - Character 10

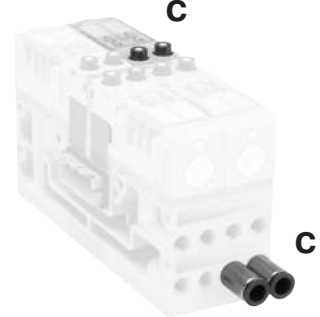

Valve Position C - Character 13
Fitting Position C - Character 14

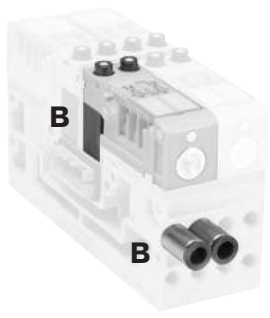

Valve Position B - Character 11
Fitting Position B - Character 12

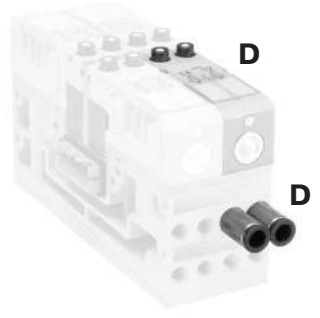

Valve Position D - Character 15
Fitting Position D - Character 16

Most popular.



For inventory, lead times, and kit lookup, visit www.pdnplu.com

Plug-in End Plate Kits

BOLD OPTIONS ARE MOST POPULAR.

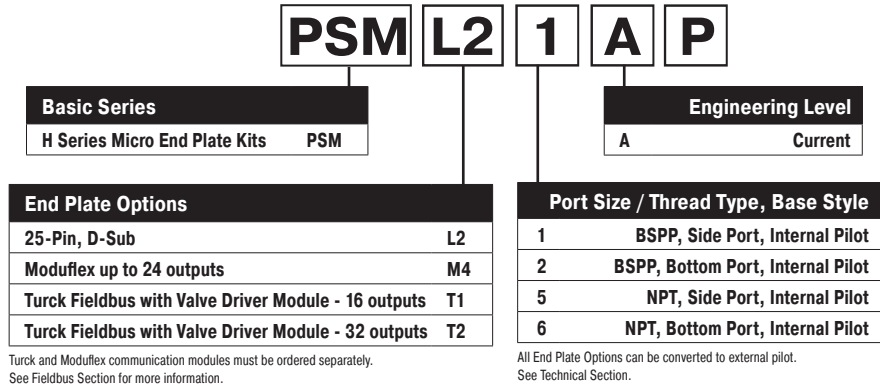

L2: 25-Pin, D-Sub End Plates

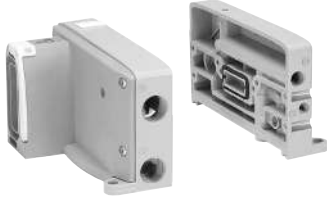

M4: Moduflex Fieldbus End Plates

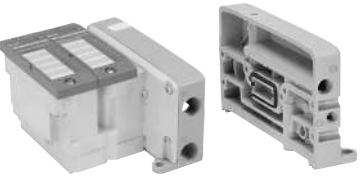

T1, T2: H Series Micro Turck End Plates

D
Subbase & Manual Valves
H Series Micro
Moduflex Series
H Series ISO
Network Connectivity
DX ISOMAX Series
Valvair II Series



For inventory, lead times, and kit lookup, visit www.pdnplu.com

How To Order Plug-in Add-A-Fold Assemblies

- List Add-A-Fold Assembly call out. This automatically includes the end plate kit assembly.
- List Simple Manifold Assemblies. List left to right, LOOKING AT THE CYLINDER PORTS on the manifold.

**Maximum Number of Solenoids
 (Maximum Energized Simultaneously)**

	Turck			
	25-pin D-sub	Moduflex	16 Outputs	32 Outputs
24VDC	24 (24)	24 (24)	16 (16)	32 (32)

Add-A-Fold Assembly Model Number

AAHM D 3 24 0 0 0 0

Valve Series	
H Series Micro Add-A-Fold	AAHM

End Plate Option	
Turck Fieldbus with Valve Driver Module - 16 Outputs	A
Turck Fieldbus with Valve Driver Module - 32 Outputs	B
25-Pin, D-Sub - 24 Outputs	D
Moduflex - Up to 24 Outputs	T

Turck Fieldbus and Moduflex communication modules must be ordered separately.

End Plate Type		
BSPP Threads	Bspp Side Port, Internal Pilot	1
	Bspp Bottom Port, Internal Pilot	2
	Bspp Side Port, External Pilot	3
	Bspp Bottom Port, External Pilot	4
NPT Threads	Npt Side Port, Internal Pilot	5
	Npt Bottom Port, Internal Pilot	6
	Npt Side Port, External Pilot	7
	Npt Bottom Port, External Pilot	8

Number of Stations*	
4 Valve Manifold	04
8 Valve Manifold	08
12 Valve Manifold	12
16 Valve Manifold	16
20 Valve Manifold	20
24 Valve Manifold	24
28 Valve Manifold	28
32 Valve Manifold	32

*For an Add-A-Fold part number to be valid, all segments must have a corresponding electrical connection at the end plate. See Maximum Number of Solenoids chart.

Pilot Exhaust on End Plate		
0	Without Fitting	
M	Muffler	
4	Straight Fitting for 4mm OD Tube	BSPP Threads
6	Straight Fitting for 6mm OD Tube	
4	Straight Fitting for 5/32 inch OD Tube	NPT Threads
7	Straight Fitting for 1/4 inch OD Tube	

M7 Pilot Port on End Plate		
Internal Pilot End Plate		
0	With Standard Plug	
External Pilot End Plate		
0	Without Fitting	
4	Straight Fitting for 4mm OD Tube	BSPP Threads
6	Straight Fitting for 6mm OD Tube	
4	Straight Fitting for 5/32 inch OD Tube	NPT Threads
7	Straight Fitting for 1/4 inch OD Tube	

3/8" Exhaust on End Plate		
0	Without Fitting	
M	Muffler	
8	Straight Fitting for 8mm OD Tube	BSPP Threads
A	Straight Fitting for 10mm OD Tube	
7	Straight Fitting for 1/4 inch OD Tube	NPT Threads
9	Straight Fitting for 3/8 inch OD Tube	

3/8" Inlet Port on End Plate		
0	Without Fitting	
8	Straight Fitting for 8mm OD Tube	BSPP Threads
A	Straight Fitting for 10mm OD Tube	
7	Straight Fitting for 1/4 inch OD Tube	NPT Threads
9	Straight Fitting for 3/8 inch OD Tube	

Note:
 BSPP fittings can only be used with BSPP Manifolds.
 NPT fittings can only be used with NPT Manifolds.

Most popular.



For inventory, lead times, and kit lookup, visit www.pdnplu.com

D Subbase & Manual Valves
 H Series Micro
 Moduflex Series
 H Series ISO
 Network Connectivity
 DX ISOMAX Series
 Valvair II Series

25-pin, D-Sub Manifolds

24 Single Solenoid Valves

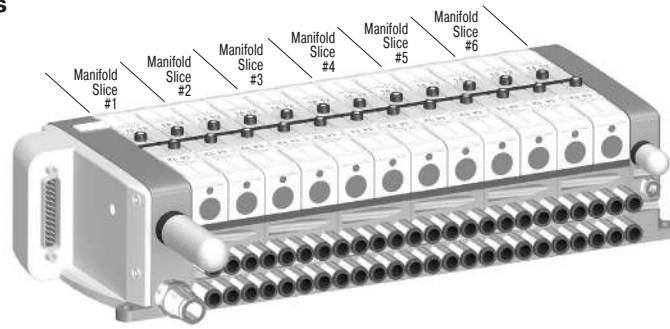

Add-A-Fold

Manifold is factory assembled and tested for pneumatic leaks and electrical continuity.

Item	Qty	Description	Part Number
01	1	24 valve Add-A-Fold with end plates	AAHMD5249M0M
02	6	4 valve simple manifold slices #1-6	PSM31JAPE7E7E7E7

Component Level

Item	Qty	Description	Part Number
01	1	25-pin, D-sub, end plate	PSML25AP
02	24	Single solenoid valve	HMEVX2049A
03	6	Manifold, side ported, single address	PSM21JAP
04	50	1/4" Tube fittings (in box quantity)	PS567925
05	10	3/8" Tube fittings (in box quantity)	PS568338
06	1	3/8" Exhaust muffler	P6M-PAB3
07	1	1/8" Exhaust muffler	P6M-PAB1

Sandwich Regulator

Description	Kit Number
 Common port regulator, 5 to 125 PSI with gauge	PSMRAX6AP

Notes: Cv values are reduced when using a sandwich regulator to 0.20 for 2-position and Dual 3/2 valves, and 0.17 for 3-position APB valves.

The sandwich regulator passes full pilot pressure from the manifold, allowing the regulated pressure to adjusted down to 5 PSI without affecting valve functionality.



Flow Controls

Description	Kit Number
 4mm to 4mm or 5/32" to 5/32" OD tube	FC832-5/32
1/4" to 1/4" O.D. tube	FC832-4

 Most popular.

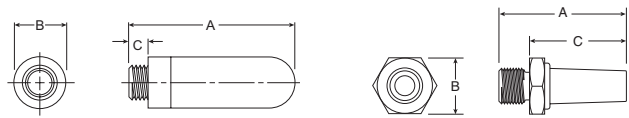
Mufflers





Port Thread	A	Ø B	C	Weight (grams)	Part Number
 1/8 pilot exhaust – BSP or NPT	1.14 (29)	0.55 (14)	0.24 (6)	0.02	P6M-PAB1
 3/8 main exhaust – BSP or NPT	2.36 (60)	0.98 (25)	0.35 (9)	0.06	P6M-PAB3
 M7 x 1 bottom port pilot exhaust *	0.98 (25)	0.43 (11)	0.75 (19)	5	P0568800

Note: Recommended tube durometer of 95 or higher. A tube support may be required if tube durometer is less than 95.

* Must be order in multiples of 10.

Fittings – Must be ordered in multiples of 10

Thread	Tube O.D.	Part Number
Manifold or pilot supply ports – straight		
 M7	4mm or 5/32"	PS567904
M7	6mm	PS567906
M7	1/4"	PS567925
Main inlet or exhaust ports		
 3/8" NPT	1/4"	PS568325
3/8" NPT	3/8"	PS568338
3/8" BSPP	8mm	PS568308
3/8" BSPP	10mm	PS568310
Pilot exhaust ports		
 1/8" NPT	5/32"	PS568215
1/8" NPT	1/4"	PS568225
1/8" BSPP	4mm	PS568204
1/8" BSPP	6mm	PS568206



For inventory, lead times, and kit lookup, visit www.pdnplu.com

Moduflex Fieldbus Manifold

**4 Double Solenoid Valves,
 8 Single Solenoid Valves**

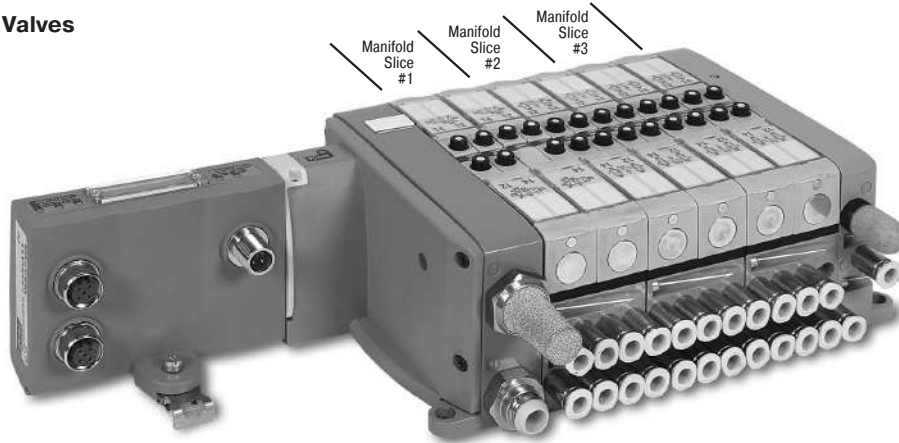

Add-A-Fold

Manifold is factory assembled and tested for pneumatic leaks and electrical continuity. P2M IO-Link Module ordered separately.

Item	Qty	Description	Part Number
01	1	12 valve add-a-fold with end plates	AAHMT5129M0M
02	1	4 valve simple manifold slice #1	PSM31MAPN7N7N7N7
03	2	4 valve simple manifold slice #2-3	PSM31JAPE7E7E7E7

Component Level

Item	Qty	Description	Part Number
01	1	Moduflex fieldbus, end plate	PSMM45AP
02	4	Double solenoid, dual 3/2, NC/NC	HMN VX2049A
03	1	Manifold, side ported, double address	PSM21MAP
04	8	Single solenoid valve	HMEVX2049A
05	2	Manifold, side ported, single address	PSM21JAP
06	30	1/4" tube fittings (in box quantity)	PS567925
05	10	3/8" tube fittings (in box quantity)	PS568338
06	1	3/8" exhaust muffler	P6M-PAB3
07	1	1/8" exhaust muffler	P6M-PAB1

Additional Components

**Moduflex Communication Modules
 Industrial Ethernet – IP65**

Industrial Ethernet Protocol	Maximum Addresses †	Part Number
EtherNet/IP (<i>Safe Power Capable</i>)	24 †	P2M2HBVE12400
PROFINET (<i>Safe Power Capable</i>)	24 †	P2M2HBVN12400
EtherCAT (<i>Safe Power Capable</i>)	24 †	P2M2HBVT12400
Modbus/TCP (<i>Safe Power Capable</i>)	24 †	P2M2HBVM12400
PowerLink (<i>Safe Power Capable</i>)	24 †	P2M2HBVW12400

Industrial Ethernet – IP20

Industrial Ethernet Protocol	Maximum Addresses †	Part Number
Profinet IO	24 †	P2M2HBVE12400RJ
EtherNet/IP	24 †	P2M2HBVN12400RJ
EtherCAT	24 †	P2M2HBVT12400RJ

† 24 addresses capable when used with H Micro and H ISO only

Most popular.

IO-Link

IO-Link - 24 outputs	Part Number
Class A 3-Pin, Aux power 1 & 3	P2M2HBVL12400A13
3-Pin, Aux power 4 & 3	P2M2HBVL12400A43
3-Pin, Aux power 4 & 2	P2M2HBVL12400A42
Class B 5-Pin, Aux power 2 & 5	P2M2HBVL12400B25

Note: For Safe Power Capable version, add "-SPC" to end of part number

IO-Link

Bus Protocol	Connector Type	Part Number
Power & Communication Cable	5-pin male to female cable, TPE	RKC 4.5T-* -RSC 4.5T/S1587

Where * = 1, 2, 3, 4, 5, 10, 20 meter standard lengths

D

Subbase & Manual Valves

H Series Micro

Moduflex Series

H Series ISO

Network Connectivity

DX ISOMAX Series

Valvair II Series



For inventory, lead times, and kit lookup, visit www.pdnplu.com

Turck Fieldbus Manifold

12 Double Solenoid Valves, 8 Single Solenoid Valves

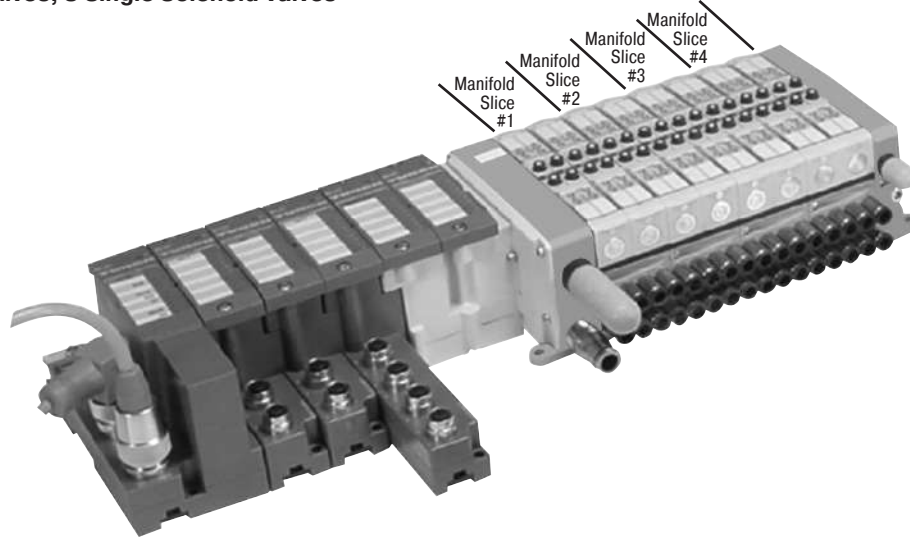

Add-A-Fold

Manifold is factory assembled and tested for pneumatic leaks and electrical continuity.

Item	Qty	Description	Part Number
01	1	16 valve add-a-fold with end plates	AAHMB4169M0M
02	2	4 valve simple manifold slices #1-3	PSM31MAPN7N7N7N7
03	2	4 valve simple manifold slices #4-5	PSM31JAPE7E7E7E7

Component Level

Item	Qty	Description	Part Number
01	1	Turck Communications with 32 output	PSMT25AP
02	12	Double solenoid, dual 3/2, NC/NC	HMNvX2049A
03	3	Manifold, side ported, double address	PSM21MAP
04	4	Single solenoid, 2-position, air return, spring assist	HMEVX2049A
05	1	Manifold, side ported, single address	PSM21JAP
06	40	1/4" tube fittings (in box quantity)	PS567925
07	10	3/8" tube fittings (in box quantity)	PS568338
08	1	3/8" exhaust muffler	P6M-PAB3
09	1	1/8" exhaust muffler	P6M-PAB1

Additional Components

Description	Part Number
Turck Ethernet IP Communications	PSSCDM12A

 Most popular.



For inventory, lead times, and kit lookup, visit www.pdnplu.com

D11

Parker Hannifin Corporation
 Pneumatic Division
 Richland, Michigan
www.parker.com/pneumatics

D

Subbase & Manual Valves

H Series Micro

Moduflex Series





H Series ISO

Network Connectivity

DX ISOMAX Series

Valvair II Series

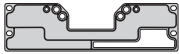
Manifold to Manifold Gaskets*

	Description	Part Number
	All galleys passing	PSM0001
	Main pressure to rear or front valves blocked, exhaust passing	PSM0002
	Main pressure to rear or front valves blocked, exhaust blocked	PSM0003
	All galleys blocked	PSM0004

* Includes 1 Gasket

Solenoid Kit

Description	Part Number
 24VDC solenoid kit with screws	PSM0010

Blanking Plate Kits

Description	Part Number
 Blanking plugs, gasket, and mounting screws.	HMBVX00XXA

Blanking plugs must be inserted into the 2 and 4 ports of the manifold corresponding to the blanking plate.

Intermediate Air Supply Base

Description	Part Number
 Gasket and mounting screws.	HMCVX00XXA

Fittings (not included) must be inserted into the 2 and 4 ports of the manifold corresponding to the intermediate air supply. Auxiliary pressure should be supplied through these fittings, which will directly feed the #1 pressure galley.

Override Caps

Description	Part Number
 Set of 10 manual override caps	PSM0011

Gaskets and Valve Screws

Description	Part Number
 Set of 5 valve to manifold gaskets and 10 screws	PSM0012

Regulator Gauge

Description	Part Number
 5 to 125 PSI gauge	P0566202

Plugs

Description	Part Number
 Set of 10 M7 plugs (Part No. PS567900) for auxiliary and pilot pressure ports	PSM0013

Screws

Description	Part Number
 Set of 10 manifold to manifold M3 screws	PSM0014

Valve Labels*

Description	Part Number
Single solenoid diagram	PSM002E
Double solenoid diagram	PSM0022
Double solenoid diagram – APB	PSM0025
Double solenoid diagram – Dual 3/2 NC/NC	PSM002N
Double solenoid diagram – Dual 3/2 NO/NO	PSM002P
Double solenoid diagram – Dual 3/2, 14 end NO, 12 end NC	PSM002Q

*Includes 10 Labels.

Protective Cover

Description	Part Number
 Protective polyester cover Set of 10	PS5706

25-Pin, D-Sub Cable (Female)

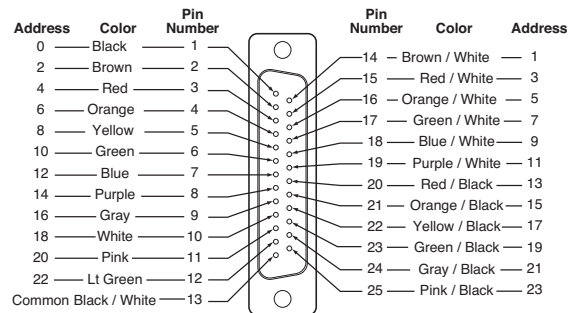

Description	Length	Part Number
25-pin, D-sub cable, IP20	3 meters	P8LMH25M3A
 25-pin, D-sub cable, IP20	9 meters	SCD259D
25-pin, D-sub cable, IP65	3 meters	SCD253W
25-pin, D-sub cable, IP65	9 meters	SCD259WE

D
 Subbase & Manual Valves
 H Series Micro
 Modulflex Series
 H Series ISO
 Network Connectivity
 DX ISOMAX Series
 Valvair II Series



For inventory, lead times, and kit lookup, visit www.pdnplu.com

Pilot Configuration

Side Ported

Manifolds can be configured for either internal or external pilot in the field. Side ported manifolds are configured for internal pilot when the M7 plug is located in the Px port on the front of the right hand end plate. Moving this plug to the internal pilot port of the right hand end plate and replacing it with a fitting allows an external pilot to be used.

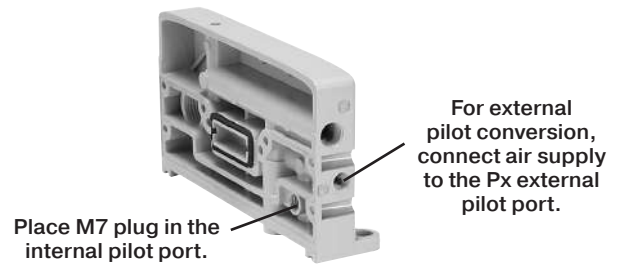

Bottom Ported

Bottom ported manifolds are configured for internal pilot when the M7 plug is located in the Px port on the bottom of the right hand end plate. Moving this plug to the internal pilot port of the right hand end plate and replacing it with a fitting allows an external pilot to be used.

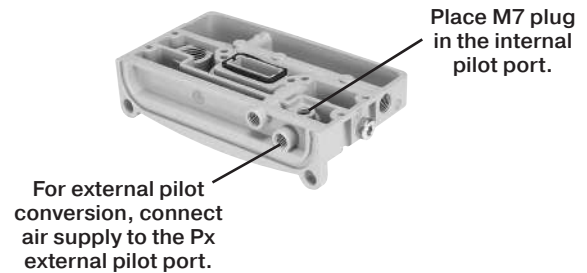

Pilot Pressure Requirements

Internal pilot pressure is supplied to the entire manifold from the right hand end plate, where the main pressure for the front row of valves is connected to the pilot pressure galley.

Maximum pilot pressure is 120 PSI. For applications requiring working pressures from 120 to 145 PSI, an external pilot supply less than 120 PSI is required.

Valve Number	Minimum Pilot Pressure	Maximum Pilot Pressure
HMEVX2049A	40 PSI	120 PSI
HM2VX2049A	25 PSI	120 PSI
HM5VX2049A	45 PSI	120 PSI
HMNVX2049A	40 PSI	120 PSI
HMPVX2049A	40 PSI	120 PSI
HMQVX2049A	40 PSI	120 PSI

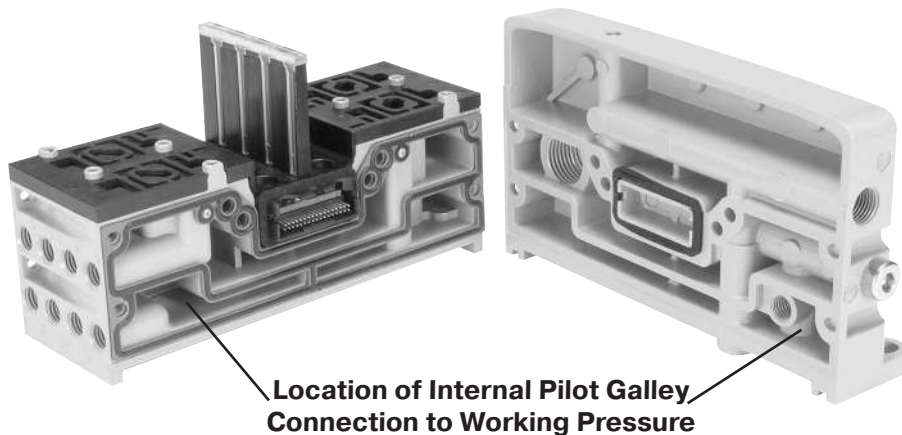

Single Solenoid - Single Address Manifolds

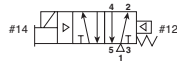

Single Pressure At Inlet Port 1:

De-energized position – Solenoid operator # 14 de-energized. Pressure at inlet port 1 connected to outlet port 2. Outlet port 4 connected to exhaust port 5.

Energized position – Solenoid operator # 14 energized. Pressure at inlet port 1 connected to outlet port 4. Outlet port 2 connected to exhaust port 3.

HMEVX2049A - Single Address Manifolds

Valve Position A		Valve Position C	
Output 0			
On	Off	On	Off
1→4	1→2	1→4	1→2
3←2	5←4	3←2	5←4
Valve Position B			
Output 1			
On	Off	On	Off
1→4	1→2	1→4	1→2
3←2	5←4	3←2	5←4
Valve Position D			
Output 3			
On	Off	On	Off
1→4	1→2	1→4	1→2
3←2	5←4	3←2	5←4

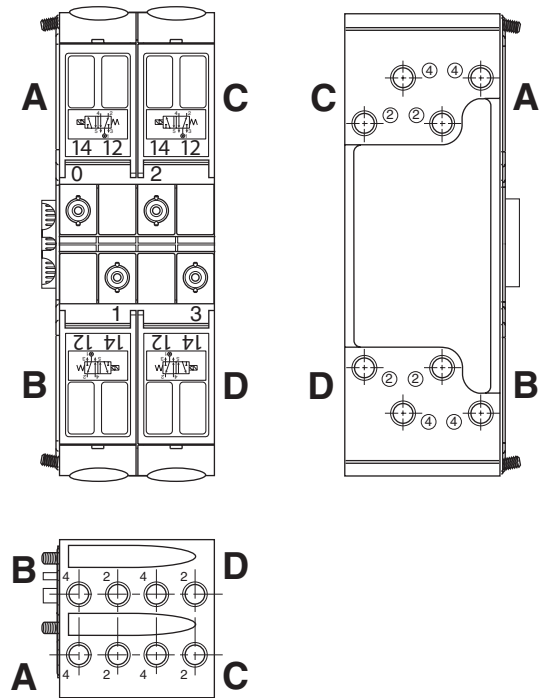

Single Solenoid - Double Address Manifolds

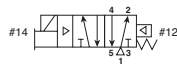

Single Pressure At Inlet Port 1:

De-energized position – Solenoid operator # 14 de-energized. Pressure at inlet port 1 connected to outlet port 2. Outlet port 4 connected to exhaust port 5.

Energized position – Solenoid operator # 14 energized. Pressure at inlet port 1 connected to outlet port 4. Outlet port 2 connected to exhaust port 3.

HMEVX2049A - Double Address Manifolds

Valve Position A				Valve Position C			
Output 0		Output 1		Output 4		Output 5	
On	Off	On	Off	On	Off	On	Off
1→4	1→2	1→2	1→2	1→4	1→2	1→2	1→2
3←2	5←4	5←4	5←4	3←2	5←4	5←4	5←4
Output Lost				Output Lost			
Valve Position B				Valve Position D			
Output 3		Output 2		Output 7		Output 6	
On	Off	On	Off	On	Off	On	Off
1→2	1→2	1→4	1→2	1→2	1→2	1→4	1→2
5←4	5←4	3←2	5←4	5←4	5←4	3←2	5←4
Output Lost				Output Lost			

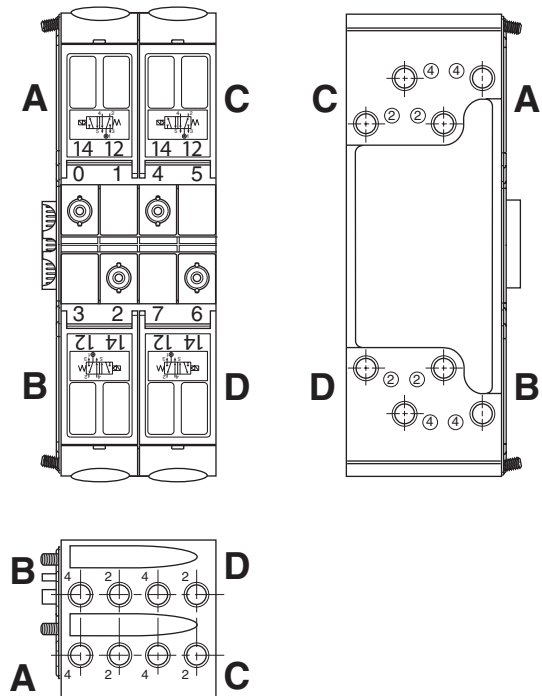

D
 Subbase & Manual Valves
 H Series Micro
 Modulflex Series
 H Series ISO
 Network Connectivity
 DX ISOMAX Series
 Valvair II Series



For inventory, lead times, and kit lookup, visit www.pdnplu.com

Double Solenoid - Double Address Manifolds, Last state #12 Energized or #14 Energized

Single Pressure At Inlet Port 1:



Solenoid operator #14 energized last. Pressure at inlet port 1 connected to outlet port 4. Outlet port 2 connected to exhaust port 3.

Solenoid operator #12 energized last. Pressure at inlet port 1 connected to outlet port 2. Outlet port 4 connected to exhaust port 5.

HM2VX2049A - Double Address Manifolds - Last state #12 Energized

Valve Position A				Valve Position C			
Output 0		Output 1		Output 4		Output 5	
On	Off	On	Off	On	Off	On	Off
1→4	1→2	1→2	1→2	1→4	1→2	1→2	1→2
3←2	5←4	5←4	5←4	3←2	5←4	5←4	5←4

Valve Position B				Valve Position D			
Output 3		Output 2		Output 7		Output 6	
On	Off	On	Off	On	Off	On	Off
1→2	1→2	1→4	1→2	1→2	1→2	1→4	1→2
5←4	5←4	3←2	5←4	5←4	5←4	3←2	5←4

HM2VX2049A - Double Address Manifolds - Last state #14 Energized

Valve Position A				Valve Position C			
Output 0		Output 1		Output 4		Output 5	
On	Off	On	Off	On	Off	On	Off
1→4	1→4	1→2	1→4	1→4	1→4	1→2	1→4
3←2	3←2	5←4	3←2	3←2	3←2	5←4	3←2

Valve Position B				Valve Position D			
Output 3		Output 2		Output 7		Output 6	
On	Off	On	Off	On	Off	On	Off
1→2	1→4	1→4	1→4	1→2	1→4	1→4	1→4
5←4	3←2	3←2	3←2	5←4	3←2	3←2	3←2

Double Solenoid - Double Address Manifolds

Dual 3-Way, 2-Position NC / NC (NNP)

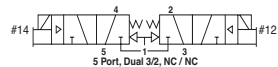

With #14 & #12 operators both de-energized – pressure at inlet port 1 blocked, outlet port 4 connected to exhaust port 5, outlet port 2 connected to exhaust port 3.

With #14 operator energized – pressure at inlet port 1 connected to outlet port 4, exhaust port 5 blocked, outlet port 2 connected to exhaust port 3.

With #12 operator energized – pressure at inlet port 1 connected to outlet port 2, exhaust port 3 blocked, outlet port 4 connected to exhaust port 5.

With #14 & #12 operators both energized – pressure at inlet port 1 connected to outlet ports 4 & 2, exhaust ports 3 & 5 blocked.

HMNVX2049A - Double Address Manifolds

Valve Position A				Valve Position C			
Output 0		Output 1		Output 4		Output 5	
On	Off	On	Off	On	Off	On	Off
1→2	1←	1→4	1←	1→2	1←	1→4	1←
3←	3←2	5←	5←4	3←	3←2	5←	5←4

Valve Position B				Valve Position D			
Output 3		Output 2		Output 7		Output 6	
On	Off	On	Off	On	Off	On	Off
1→4	1←	1→2	1←	1→4	1←	1→2	1←
5←	5←4	3←	3←2	5←	5←4	3←	3←2

A 2-Position, Double Solenoid Valve is a detented valve. When the output is removed, the spool remains in its position.

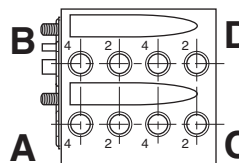
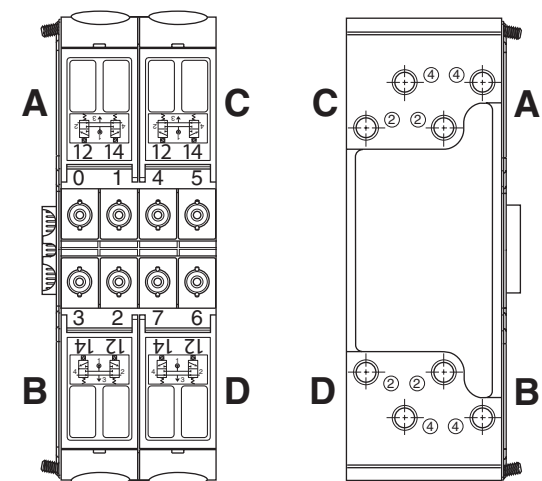
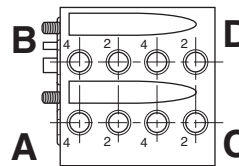
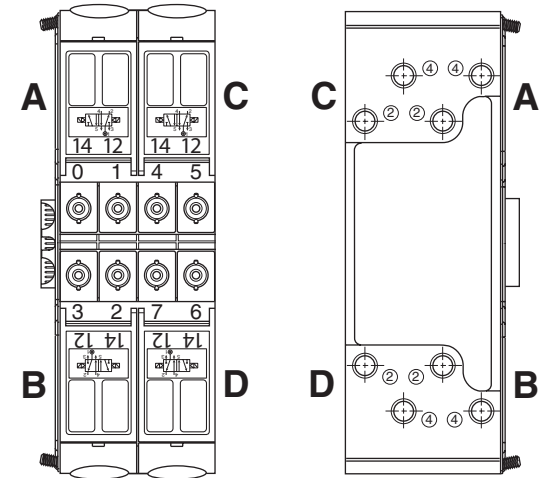

For inventory, lead times, and kit lookup, visit www.pdnplu.com

Double Solenoid - Double Address Manifolds

**Dual 3-Way, 2-Position
 NO / NO (NP)**

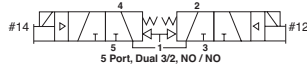

With #14 & #12 operators both de-energized – pressure at inlet port 1 connected to outlet ports 4 & 2, exhaust ports 3 & 5 blocked.

With #14 operator energized – pressure at inlet port 1 connected to outlet port 2, exhaust port 3 blocked, outlet port 4 connected to exhaust port 5.

With #12 operator energized – pressure at inlet port 1 connected to outlet port 4, exhaust port 5 blocked, outlet port 2 connected to exhaust port 3.

With #14 & #12 operators both energized – pressure at inlet port 1 blocked, outlet port 4 connected to exhaust port 5, outlet port 2 connected to exhaust port 3.

HMPVX2049A - Double Address Manifolds

Valve Position A				Valve Position C			
Output 0		Output 1		Output 4		Output 5	
On	Off	On	Off	On	Off	On	Off
1→	1→2	1→	1→4	1→	1→2	1→	1→4
3←2	3→	5←4	5→	3←2	3→	5←4	5→

Valve Position B				Valve Position D			
Output 3		Output 2		Output 7		Output 6	
On	Off	On	Off	On	Off	On	Off
1→	1→4	1→	1→2	1→	1→4	1→	1→2
5←4	5→	3←2	3→	5←4	5→	3←2	3→

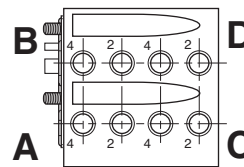
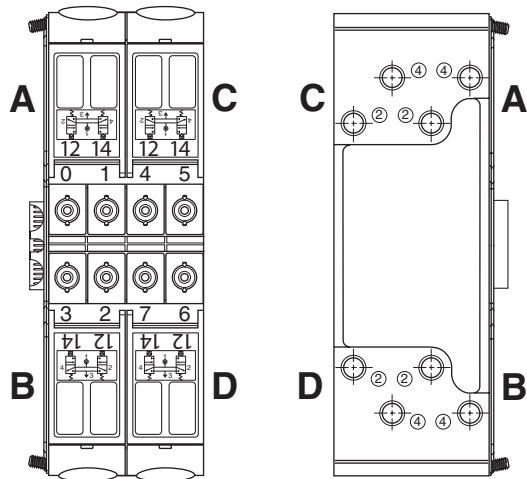

Double Solenoid - Double Address Manifolds

**Dual 3-Way, 2-Position
 14 End NO / 12 End NC
 (NP / NNP)**

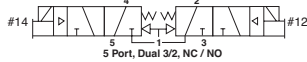

With #14 & #12 operators both de-energized – pressure at inlet port 1 connected to outlet port 4, exhaust port 5 blocked, outlet port 2 connected to exhaust port 3.

With #14 operator energized – pressure at inlet port 1 blocked, outlet port 4 connected to exhaust port 5, outlet port 2 connected to exhaust port 3.

With #12 operator energized – pressure at inlet port 1 connected to outlet ports 4 & 2, exhaust ports 3 & 5 blocked.

With #14 & #12 operators both energized – pressure at inlet port 1 connected to outlet port 2, exhaust port 3 blocked, outlet port 4 connected to exhaust port 5.

HMVX2049A - Double Address Manifolds

Valve Position A				Valve Position C			
Output 0		Output 1		Output 4		Output 5	
On	Off	On	Off	On	Off	On	Off
1→2	1→	1→	1→4	1→2	1→	1→	1→4
3→	3←2	5←4	5→	3→	3←2	5←4	5→

Valve Position B				Valve Position D			
Output 3		Output 2		Output 7		Output 6	
On	Off	On	Off	On	Off	On	Off
1→	1→4	1→2	1→	1→	1→4	1→2	1→
5←4	5→	3→	3←2	5←4	5→	3→	3←2

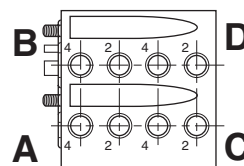
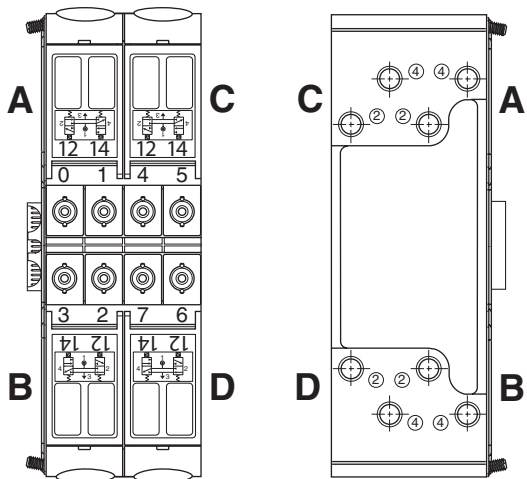

D

Subbase & Manual
 Valves

H Series
 Micro

Modulflex
 Series

H Series
 ISO

Network
 Connectivity

DX ISOMAX
 Series

Valvair II
 Series



For inventory, lead times, and kit lookup, visit www.pdnplu.com

Double Solenoid - Double Address Manifolds

3-Position

Function 5: All Ports Blocked

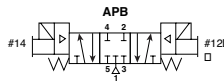

With #12 operator energized – inlet port 1 connected to cylinder port 2, cylinder port 4 connected to exhaust port 5.

With #14 operator energized – inlet port 1 connected to cylinder port 4, cylinder port 2 connected to exhaust port 3.

All ports blocked in the center position.

HM5VX2049A - Double Address Manifolds

Valve Position A			Valve Position C		
Output 0 On	Output 0 Off	Output 0 Off	Output 4 On	Output 4 Off	Output 4 Off
Output 1 Off	Output 1 On	Output 1 Off	Output 5 Off	Output 5 On	Output 5 Off
5→1	5←4	3→1 1→4	5→1	5←4	3→1 1→4
1→4	1→2	1→1 1→2	1→4	1→2	1→1 1→2
3←2	3→1	5→1	3←2	3→1	5→1

Valve Position B			Valve Position D		
Output 2 On	Output 2 Off	Output 2 Off	Output 6 On	Output 6 Off	Output 6 Off
Output 3 Off	Output 3 On	Output 3 Off	Output 7 Off	Output 7 On	Output 7 Off
5→1	5←4	3→1 1→4	5→1	5←4	3→1 1→4
1→4	1→2	1→1 1→2	1→4	1→2	1→1 1→2
3←2	3→1	5→1	3←2	3→1	5→1

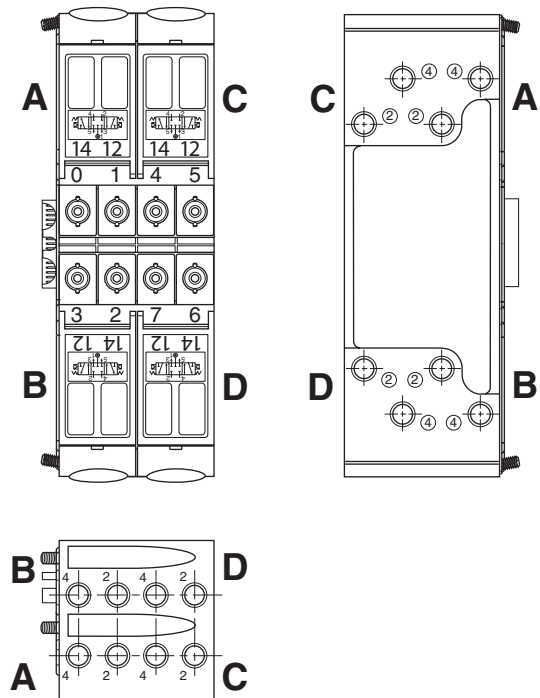

Dual 3/2 valves replace 3-position valves for better performance

3-position center exhaust

A traditional 5/3 center exhaust valve is now replaced by a double 3/2 NC+NC valve module. Both cylinder chambers are exhausted and rod and piston are free to move.

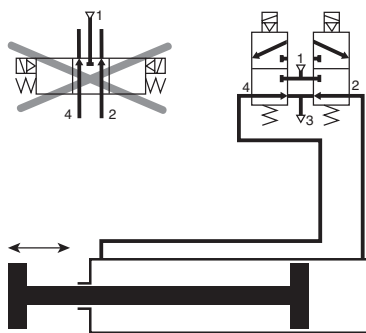

3-position pressure center

A traditional 5/3 pressure center valve is now replaced by a double 3/2 NO+NO valve module. The function is identical.

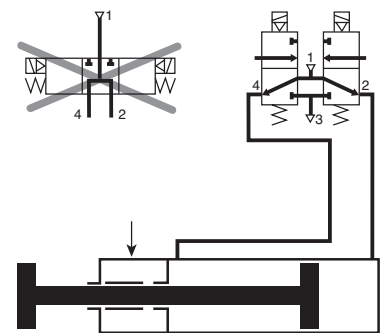

For inventory, lead times, and kit lookup, visit www.pdnplu.com

Multiple Pressure Zones

PSM0001 –

All ports open. Common pressure for front and rear manifold.
 Common exhausts.
 Standard gasket included with each manifold and end plate.

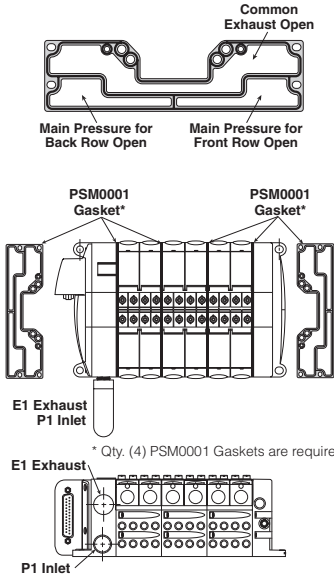

PSM0002 –

Rear manifold blocked for separate pressure supply.
 Common exhausts.
 Flip gasket to block front of manifold.

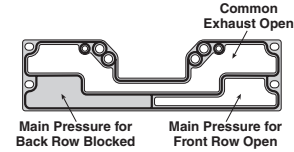

Internal Pilot Pressure from P1 Inlet

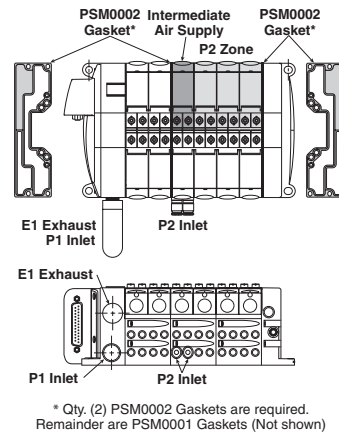

PSM0003 –

Rear manifold blocked for separate pressure supply.
 Exhaust blocked also.
 Flip gasket to block front of manifold.
 If used with bottom ported end plates, second exhaust must be piped from the side of the right end plate.

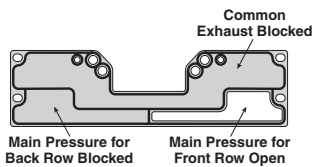

Internal Pilot Pressure from P1 Inlet

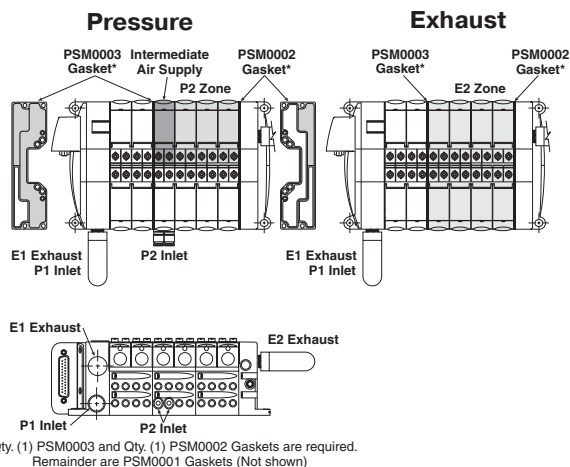

PSM0004 –

All galleys blocked.
 Two pressure zones and two exhaust zones. If used with bottom ported end plates, second exhaust must be piped from the side of the right end plate.

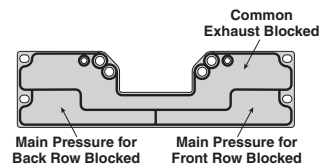

Internal Pilot Pressure from P2 Inlet

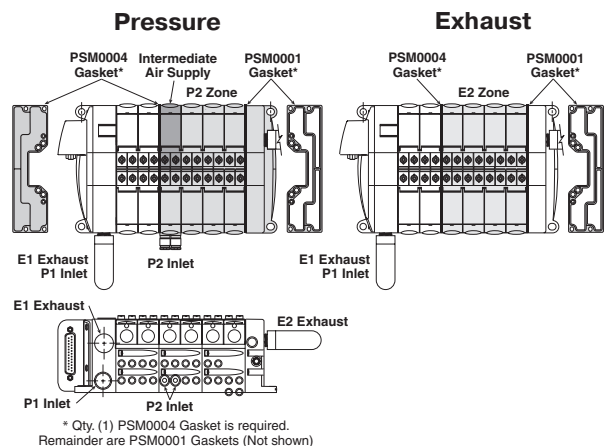

D
 Subbase & Manual Valves
 H Series Micro
 Modflex Series
 H Series ISO
 Network Connectivity
 DX ISOMAX Series
 Valvaire II Series



For inventory, lead times, and kit lookup, visit www.pdnplu.com

Maximum Number of Solenoids
 (Maximum Energized Simultaneously)

	25-Pin D-Sub	Moduflex	H Series Fieldbus*
24VDC	24 (24)	24 (24)	32 (32)

* Maximum of 32 solenoids per manifold. With Bus Extension functionality, 4 manifolds with up to 32 solenoids each can be connected on the same network.

25-Pin, D-Sub Connector (Male)

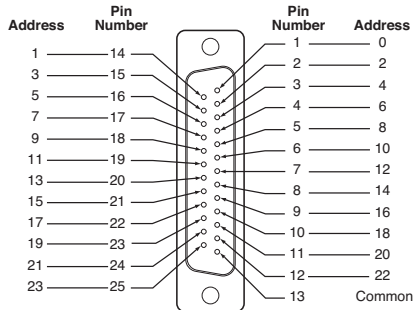

View into End Plate Connector - Male D-Sub, 25-Pin

Single Solenoid Valves Shown
Solenoid is De-energized

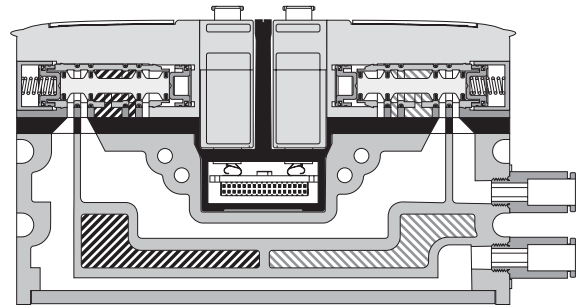

Side Exhaust
 4 Ports Connected to Exhaust Port
 (5 & 3 Common)

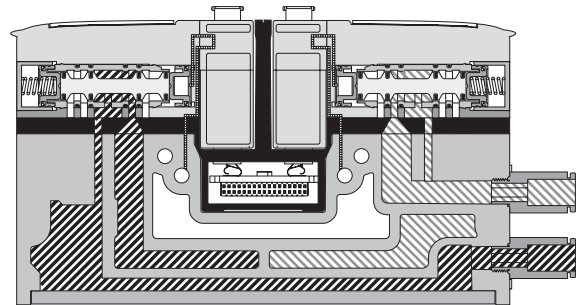

Side Pressure
 2 Ports Connected to Inlet Port 1



D

Subbase & Manual
 Valves

H Series
 Micro

Moduflex
 Series

H Series
 ISO

Network
 Connectivity

DX ISOMAX
 Series

Valvair II
 Series

Cv Values - H Series Micro

The charts below represent the minimum required Cv values for pneumatic systems operating at 80 PSI with a 5 PSI pressure drop.

To use the chart, locate the diameter of the cylinder across the horizontal axis, then the average required rod speed of the cycle. The intersection point is Cv value needed.

Grayed out values are not attainable with H Series Micro. Please select a larger Parker valve.

Average Rod Speed (mm/s)	Cylinder Diameter (mm)													
	6	8	10	12	16	20	25	32	40	50	63	80	100	
25	0.000	0.001	0.001	0.002	0.003	0.005	0.008	0.013	0.021	0.032	0.051	0.083	0.129	
50	0.001	0.002	0.003	0.004	0.007	0.010	0.016	0.026	0.041	0.065	0.103	0.166	0.259	
75	0.001	0.002	0.004	0.006	0.010	0.016	0.024	0.040	0.062	0.097	0.154	0.248	0.388	
100	0.002	0.003	0.005	0.007	0.013	0.021	0.032	0.053	0.083	0.129	0.205	0.331	0.517	
125	0.002	0.004	0.006	0.009	0.017	0.026	0.040	0.066	0.103	0.162	0.257	0.414	0.647	
150	0.003	0.005	0.008	0.011	0.020	0.031	0.049	0.079	0.124	0.194	0.308	0.497	0.776	
175	0.003	0.006	0.009	0.013	0.023	0.036	0.057	0.093	0.145	0.226	0.359	0.580	0.906	
200	0.004	0.007	0.010	0.015	0.026	0.041	0.065	0.106	0.166	0.259	0.411	0.662	1.035	
225	0.004	0.007	0.012	0.017	0.030	0.047	0.073	0.119	0.186	0.291	0.462	0.745	1.164	
250	0.005	0.008	0.013	0.019	0.033	0.052	0.081	0.132	0.207	0.323	0.513	0.828	1.294	
275	0.005	0.009	0.014	0.020	0.036	0.057	0.089	0.146	0.228	0.356	0.565	0.911	1.423	
300	0.006	0.010	0.016	0.022	0.040	0.062	0.097	0.159	0.248	0.388	0.616	0.994	1.552	
350	0.007	0.012	0.018	0.026	0.046	0.072	0.113	0.185	0.290	0.453	0.719	1.159	1.811	
400	0.007	0.013	0.021	0.030	0.053	0.083	0.129	0.212	0.331	0.517	0.822	1.325	2.070	
450	0.008	0.015	0.023	0.034	0.060	0.093	0.146	0.238	0.373	0.582	0.924	1.490	2.329	
500	0.009	0.017	0.026	0.037	0.066	0.103	0.162	0.265	0.414	0.647	1.027	1.656	2.587	

Average Rod Speed (in/s)	Cylinder Diameter (in)																
	5/16"	7/16"	9/16"	3/4"	7/8"	1"	1-1/16"	1-1/8"	1-1/4"	1-1/2"	1-3/4"	2"	2-1/2"	3"	3-1/4"	3-5/8"	4"
1	0.001	0.002	0.003	0.005	0.006	0.008	0.010	0.011	0.013	0.019	0.026	0.034	0.053	0.076	0.090	0.111	0.136
2	0.002	0.003	0.005	0.010	0.013	0.017	0.019	0.021	0.026	0.038	0.052	0.068	0.106	0.153	0.179	0.223	0.271
3	0.002	0.005	0.008	0.014	0.019	0.025	0.029	0.032	0.040	0.057	0.078	0.102	0.159	0.229	0.269	0.334	0.407
4	0.003	0.006	0.011	0.019	0.026	0.034	0.038	0.043	0.053	0.076	0.104	0.136	0.212	0.305	0.358	0.446	0.543
5	0.004	0.008	0.013	0.024	0.032	0.042	0.048	0.054	0.066	0.095	0.130	0.170	0.265	0.382	0.448	0.557	0.678
6	0.005	0.010	0.016	0.029	0.039	0.051	0.057	0.064	0.079	0.114	0.156	0.204	0.318	0.458	0.537	0.669	0.814
7	0.006	0.011	0.019	0.033	0.045	0.059	0.067	0.075	0.093	0.134	0.182	0.237	0.371	0.534	0.627	0.780	0.950
8	0.007	0.013	0.021	0.038	0.052	0.068	0.077	0.086	0.106	0.153	0.208	0.271	0.424	0.611	0.717	0.891	1.085
9	0.007	0.015	0.024	0.043	0.058	0.076	0.086	0.097	0.119	0.172	0.234	0.305	0.477	0.687	0.806	1.003	1.221
10	0.008	0.016	0.027	0.048	0.065	0.085	0.096	0.107	0.132	0.191	0.260	0.339	0.530	0.763	0.896	1.114	1.357
11	0.009	0.018	0.030	0.052	0.071	0.093	0.105	0.118	0.146	0.210	0.286	0.373	0.583	0.839	0.985	1.226	1.492
12	0.010	0.019	0.032	0.057	0.078	0.102	0.115	0.129	0.159	0.229	0.312	0.407	0.636	0.916	1.075	1.337	1.628
14	0.012	0.023	0.038	0.067	0.091	0.119	0.134	0.150	0.185	0.267	0.364	0.475	0.742	1.068	1.254	1.560	1.899
16	0.013	0.026	0.043	0.076	0.104	0.136	0.153	0.172	0.212	0.305	0.415	0.543	0.848	1.221	1.433	1.783	2.171
18	0.015	0.029	0.048	0.086	0.117	0.153	0.172	0.193	0.238	0.343	0.467	0.611	0.954	1.374	1.612	2.006	2.442
20	0.017	0.032	0.054	0.095	0.130	0.170	0.191	0.215	0.265	0.382	0.519	0.678	1.060	1.526	1.791	2.229	2.713

D
 Subbase & Manual Valves
 H Series Micro
 Modulflex Series
 H Series ISO
 Network Connectivity
 DX ISOMAX Series
 Valvair II Series



For inventory, lead times, and kit lookup, visit www.pdnplu.com

D20

Parker Hannifin Corporation
 Pneumatic Division
 Richland, Michigan
www.parker.com/pneumatics

Flow Characteristics

Dual 3/2

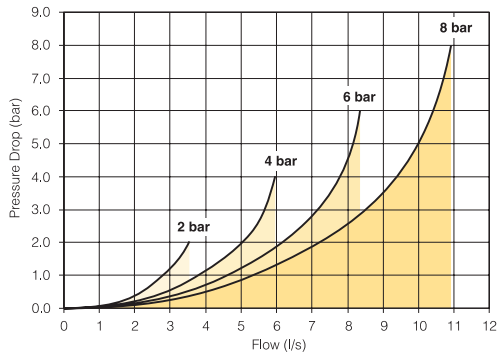

Operating pressure: 39 to 120.3 PSI (2.7 to 8.3 bar)
 Change-over time (side 14): Actuation 15 ms
 Return 20 ms P = 6b
 Change-over time (side 12): 15 ms / 25 ms P = 6b
 Flow (acc. to ISO 6358): c = 1.2 NI/s x bar
 b = 0.13
 Qn = 4.6 NI/s
 Qmax = 8.4 NI/s

5/2 single and double solenoid

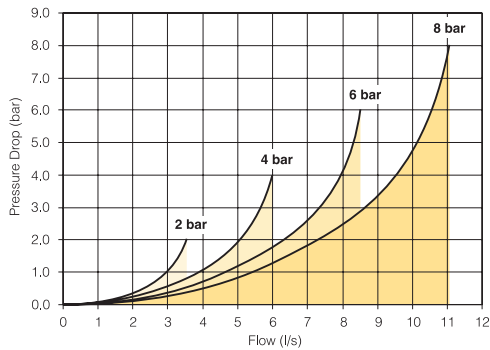

Operating pressure: Single solenoid 39 to 120.3 PSI (2.7 to 8.3 bar)
 Double solenoid 24.6 to 120.3 PSI (1.7 to 8.3 bar)
 Change-over time: Single solenoid Actuation 15 ms
 Return 20 ms P = 6b
 Double solenoid 13 ms / 13 ms P = 6b
 Flow (acc. to ISO 6358): c = 1.2 NI/s x bar
 b = 0.13
 Qn = 4.7 NI/s
 Qmax = 8.5 NI/s

5/3 all ports blocked

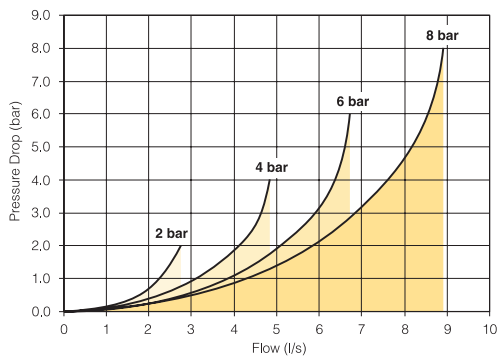

Operating pressure: 39 to 120.3 PSI (2.7 to 8.3 bar)
 Change-over time: Actuation 20 ms
 Return 20 ms P = 6b
 Flow (acc. to ISO 6358): c = 1 NI/s x bar
 b = 0.14
 Qn = 3.8 NI/s
 Qmax = 6.7 NI/s

Characteristics

Fluid:	Air or inert gas Filtered 40 μ Class 5 (according to ISO 8573-1) Dry class 4 (according to ISO 8573-1) Non-lubricated or lubricated	Operating pressure:	-13 to 120.3 PSI (-0.9 to 8.3 bar) with external pressure 87 PSI (6 bar)
Storage temperature:	104°F to 158°F (-40°C to 70°C)	Piloting pressure:	37 to 120.3 PSI (2.7 to 8.3 bar)
Working temperature:	5°F to 122°F (-15°C to 50°C)	Exhaust collection:	Independent exhaust collection
Vibration:	according to IEC 68-2-6 2G to 150 Hz	Rated coil voltage:	24 VDC -15 % / +10 %
Shock:	according to IEC 68-2-27 15G 11 ms	Electrical connection:	Not polarized
		Coil insulation:	Class B
		Power consumption:	1 W (42 mA) with LED
		Duty factor:	100 % at 68°F (20°C)

D
 Subbase & Manual Valves
 H Series Micro
 Moduflex Series
 H Series ISO
 Network Connectivity
 DX ISOMAX Series
 Valvair II Series



For inventory, lead times, and kit lookup, visit www.pdnplu.com

D21

Parker Hannifin Corporation
 Pneumatic Division
 Richland, Michigan
www.parker.com/pneumatics

25-pin, D-Sub with H Series Micro Valves, Side Ported

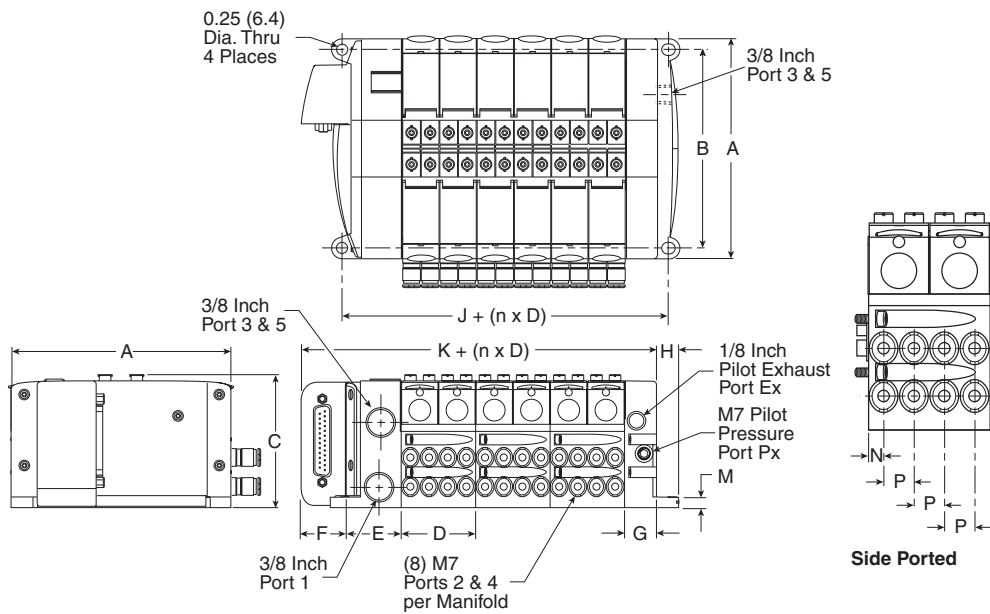

Dimensions

A	B	C	D
4.88	4.41	2.95	1.65
(124.0)	(112.0)	(75.0)	(42.0)

E	F	G	H
1.22	1.02	0.71	0.49
(31.0)	(26.0)	(18.0)	(12.5)

J	K	M	N
2.28	3.44	0.24	0.21
(58.0)	(87.5)	(6.1)	(5.2)

P
0.41
(10.5)

Inches (mm)
 n = Number of manifolds

Side Ported

25-pin, D-Sub with H Series Micro Valves, Bottom Ported

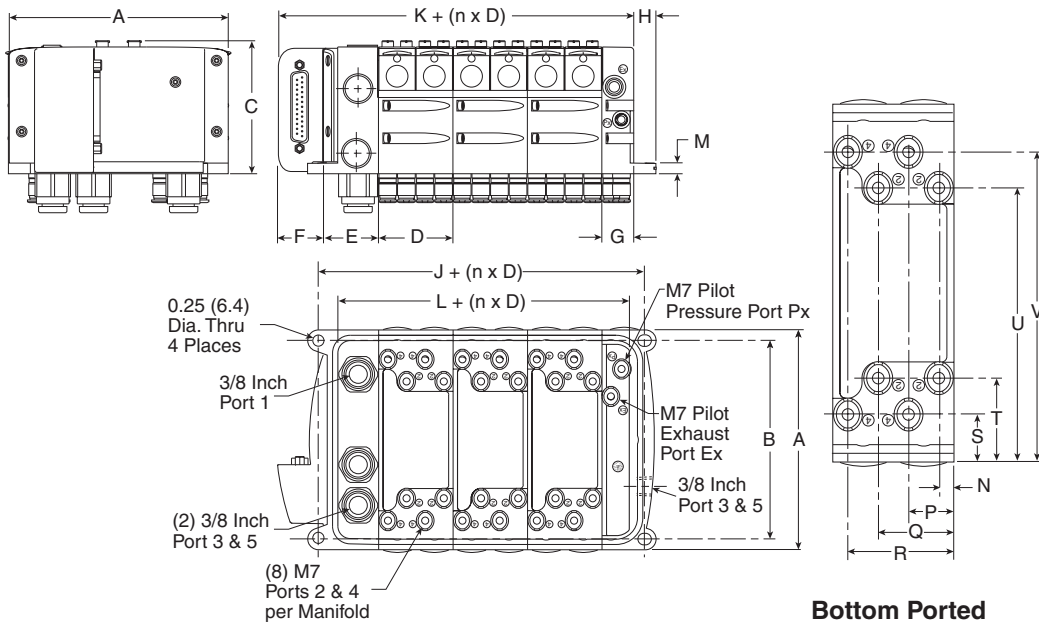

Dimensions

A	B	C	D
4.88	4.41	2.95	1.65
(124.0)	(112.0)	(75.0)	(42.0)

E	F	G	H
1.22	1.02	0.71	0.49
(31.0)	(26.0)	(18.0)	(12.5)

J	K	L	M
2.28	3.44	1.69	0.24
(58.0)	(87.5)	(43.0)	(6.1)

N	P	Q	R
0.21	0.62	1.03	1.45
(5.3)	(15.8)	(26.3)	(36.8)

S	T	U	V
0.64	1.14	3.73	4.23
(16.40)	(29.0)	(94.9)	(107.4)

Inches (mm)
 n = Number of manifolds

Bottom Ported Detail

Note:
 See Fieldbus Section for the dimensions of manifolds utilizing the H Series Fieldbus, Turck, or Modflex end plate type.



For inventory, lead times, and kit lookup, visit www.pdnplu.com

D22

Parker Hannifin Corporation
 Pneumatic Division
 Richland, Michigan
www.parker.com/pneumatics

D
 Subbase & Manual Valves
 H Series Micro
 Modflex Series
 H Series ISO
 Network Connectivity
 DX ISOMAX Series
 Valvair II Series

Turck with H Series Micro Valves, Side Ported

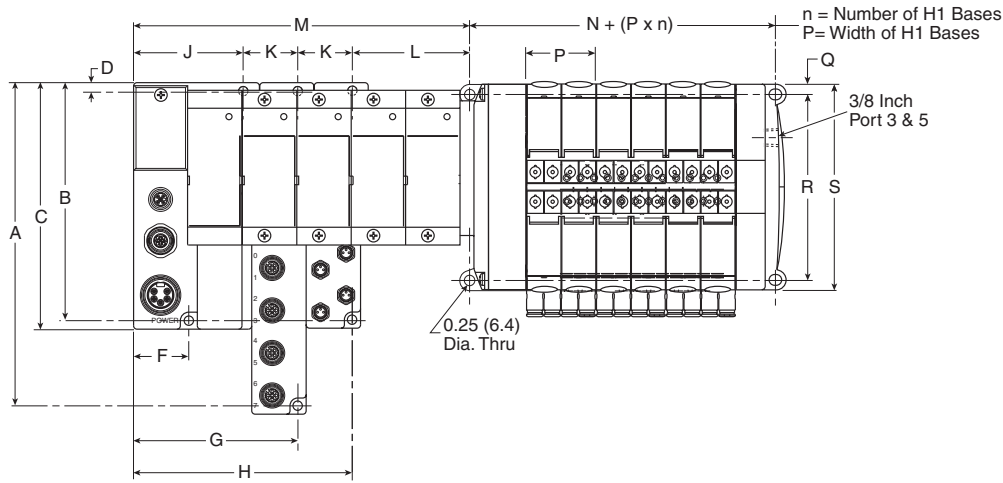

Dimensions

A	B	C	D
7.48 (190)	5.51 (140)	5.71 (145)	0.20 (5)
F	G	H	J
1.28 (32.5)	3.79 (96.5)	5.06 (128.5)	2.53 (64.5)
K	L	M	N
1.26 (32)	2.54 (64)	See note 1	2.28 (58)
P	Q	R	S
1.65 (42)	.19 (4.9)	4.41 (112)	4.88 (124)

Note 1: $M = J + L + n_2 \times K$, where n_2 = Number of Turck input / output modules
Inches (mm)

Sandwich Regulator

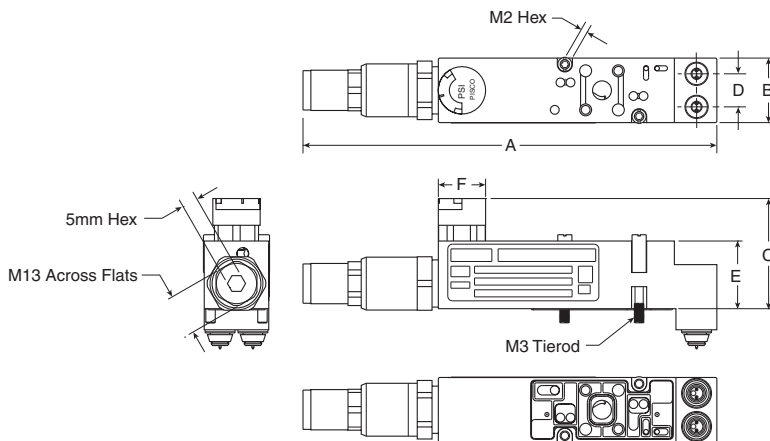

Dimensions

A	B	C	D
5.20 (132)	0.81 (20.5)	1.38 (35)	0.41 (10.5)
E	F		
0.85 (21.5)	0.59Ø (15Ø)		

Inches (mm)

M7 Fittings

PS567900 – Kit PSM0013

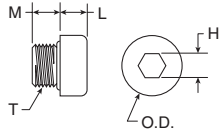

Part no.	L	M	H hex	T thread	O.D.
PS567900	0.18 (4.5)	0.20 (5)	0.16 (4)	M7 x 1	0.39 (10)

PS567906

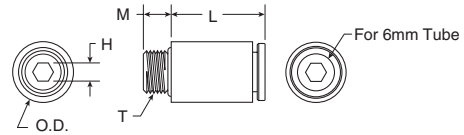

Part no.	Tube size	L	M	H Hex	T thread	O.D.
PS567906	6mm	0.63 (16)	0.20 (5)	0.12 (3)	M7 x 1	0.39 (10)

PS567904

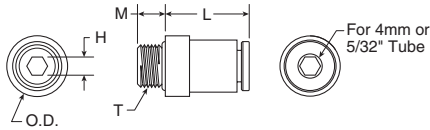

Part no.	Tube size	L	M	H Hex	T thread	O.D.
PS567904	4mm or 5/32"	0.55 (14)	0.20 (5)	0.12 (3)	M7 x 1	0.39 (10)

PS567925

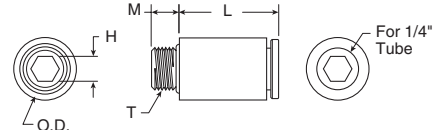

Part no.	Tube size	L	M	H Hex	T thread	O.D.
PS567925	1/4"	0.65 (16.5)	0.18 (4.6)	0.16 (4)	M7 x 1	0.41 (10.3)

1/8 Inch Fittings

PS568204

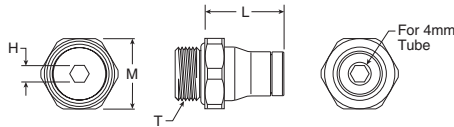

Part No.	Tube Size	L	M Hex	H Hex	T Thread
PS568204	4mm	0.57 (14.5)	0.51 (13)	0.12 (3)	G1/8

PS568215

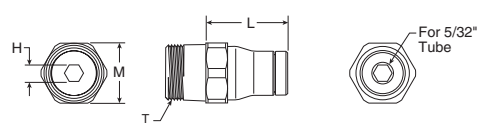

Part No.	Tube Size	L	M Hex	H Hex	T Thread
PS568215	5/32"	0.59 (15)	0.43 (11)	0.12 (3)	1/8 NPT

PS568206

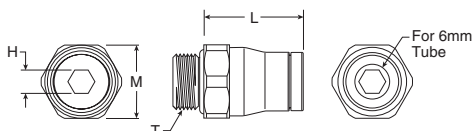

Part no.	Tube size	L	M Hex	H Hex	T thread
PS568206	6mm	0.69 (17.5)	0.51 (13)	0.16 (4)	G1/8

PS568225

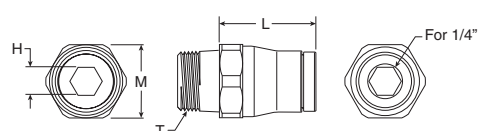

Part no.	Tube size	L	M Hex	H Hex	T thread
PS568225	1/4"	0.67 (17)	0.51 (13)	0.20 (5)	1/8 NPT

D

Subbase & Manual
Valves

H Series
Micro

Modulflex
Series

H Series
ISO

Network
Connectivity

DX ISOMAX
Series

Valvair II
Series



For inventory, lead times, and kit lookup, visit www.pdnplu.com

3/8 Inch Fittings

PS568308

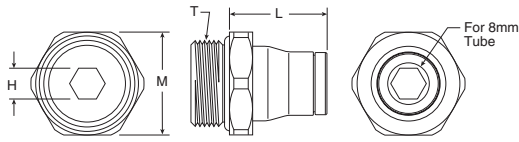

Part no.	Tube size	L	M Hex	H Hex	T thread
PS568308	8mm	0.75 (19)	0.79 (20)	0.24 (6)	G3/8

PS568325

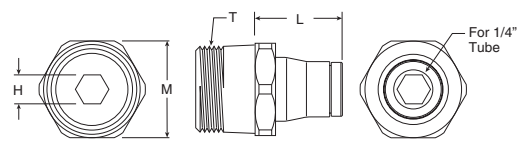

Part no.	Tube size	L	M Hex	H Hex	T thread
PS568325	1/4"	0.67 (17)	0.71 (18)	0.20 (5)	3/8 NPT

PS568310

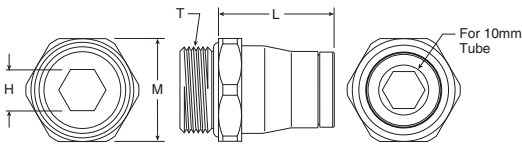

Part no.	Tube size	L	M Hex	H Hex	T thread
PS568310	10mm	0.89 (22.5)	0.79 (20)	0.31 (8)	G3/8

PS568338

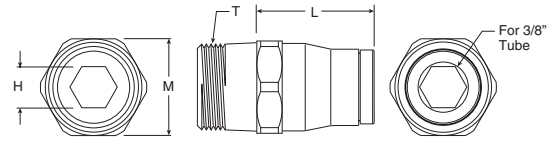

Part no.	Tube size	L	M Hex	H Hex	T thread
PS568338	3/8"	0.91 (23)	0.71 (18)	0.31 (8)	3/8 NPT

D

Subbase & Manual
Valves

H Series
Micro

Moduflex
Series

H Series
ISO

Network
Connectivity

DX ISOMAX
Series

Valvair II
Series



For inventory, lead times, and kit lookup, visit www.pdnplu.com

Features

Moduflex Series

The Moduflex Valve System redefines flexibility for pneumatic users. Whether configured from basic components or ordered as a pre-assembled and tested valve manifold, Moduflex flexibility is unmatched in the market place.

Ports

- Size 1: Push-in connectors for 5/32, 1/4 inch, 4, 6mm OD tube
- Size 2: Push-in connectors for 1/4, 3/8, 1/2 inch, 6, 8, 10 OD tube

Mounting

- S Series – Individual subbase
- T Series – Manifold mount with individual connectors
- V Series – Manifold mount with collective wiring or fieldbus

Network Connectivity Options

- Industrial Ethernet – EtherNet/IP, PROFINET, Modbus TCP, PowerLink, EtherCAT
- IO-Link – Class A & Class B

Solenoids

- 1.0 Watt
- 24 VDC
- Compatible with PNP or NPN outputs

Certification / approval

- IP65 rated
- CE, as marked

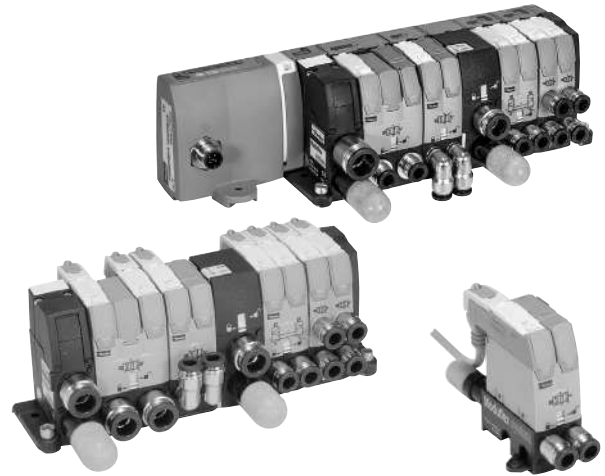

Operating Information

Operating pressure:	Vacuum to 123 PSIG (Vacuum to 8.3 bar)
Operating temperature:	5°F to 140°F (-15°C to 60°C)
Fieldbus operating temperature:	32°F to 130°F (0°C to 55°C)

Material specifications

End plates (T and V series)	Plastic
Fasteners	Nickel plated steel
Spool	Aluminum and nitrile rubber or ceramic plate
Subbase or manifold	Plastic
Valve body	Plastic

D	Subbase & Manual Valves
	H Series Micro
Moduflex Series	
H Series ISO	
Network Connectivity	
DX ISOMAX Series	
Valvair II Series	

Most popular.



For inventory, lead times, and kit lookup, visit www.pdnplu.com

Features

Module Series Selection and Assembly Procedures

Moduflex system provides a complete choice of either stand-alone valves, short-build valve islands, or large valve island configurations. Electrical control connections may be individual or island integrated. Peripheral modules add complementary functions — flow control, pressure regulation, P.O. check valves and vacuum generators can be added directly to the valve or used as a stand alone product.

Moduflex gives machine builders maximum flexibility to assemble each automation system step by step using basic modules.

Valve islands can be easily assembled using the following procedure.

1. Assemble the required valve island with the basic modules.
2. Mount the valve island on the machine together with any stand-alone valves and peripheral modules.
3. Select and install the required clip-on pneumatic and electrical connectors.

“S” Series Stand Alone Valves

For isolated cylinders on a machine, it is preferable to locate the valve close by. Therefore a stand-alone module is ideal. Response time and air consumption are then reduced to a minimum. Peripheral modules can be installed directly into the valve.



“S” Series Size 1 Single Solenoid



“S” Series Size 1 Single Air Pilot



Straight or Elbow Pneumatic Connectors



Union Pneumatic Connectors

Dual P.O. Check Valve



Subbase & Manifold Valve Products “S” & “T” Series

“T” Series Valve Island Modules with Individual Connectors

For small groups of cylinders requiring short localized valve islands, it is convenient to use individual electrical connector islands.



“T” Series Island Modules

“T” Series modules are easily assembled to form a complete manifold. All electrical connectors are individual and pneumatic connectors are of the push-in tube type. Modules with different functions and flow passages may be combined in the same island manifold, giving total flexibility to adapt to all machine requirements.

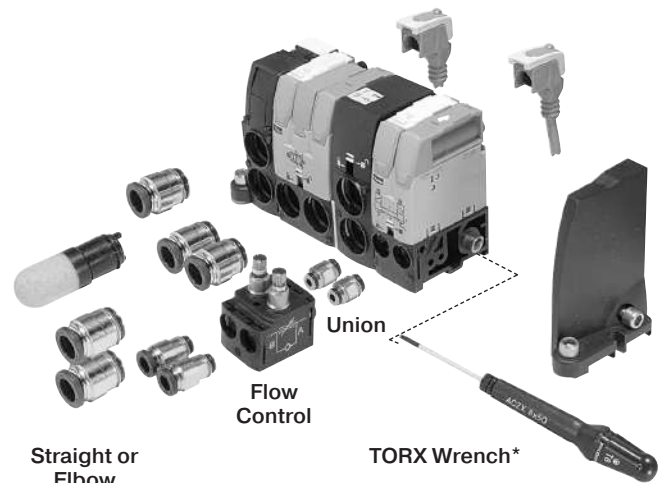

Straight or Elbow Pneumatic Connectors

Flow Control

Union

TORX Wrench*

* Maximum torque rating 10.6 in. lbs. (1.2 Nm).



M8 2-pin, male connector

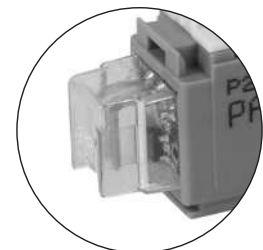

Clip Connector with LED & surge protection

Features

“V” Series Valve Island Modules with Integrated Connections

When the number of valves is larger, modular islands are easily assembled using the integrated electrical connection series. These islands are then connected to the control PLC, with a multi-connector cable or with a fieldbus connection.



“V” Series with 20-Pin Connector



“V” Series with Field Bus Connection

“V” Series modules are easily assembled to form a complete manifold. All pneumatic connectors are of the push-in tube type. When the valve island has been installed, it is a simple operation to separate the field bus module from the valve island using the quick release lever. Modules with different functions and flow passages may be combined in the same island manifold, giving total flexibility to adapt to all machine requirements.

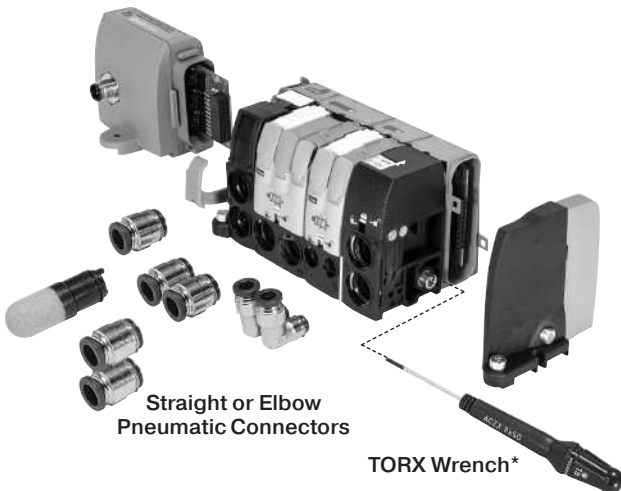

Straight or Elbow Pneumatic Connectors

TORX Wrench*

* Maximum torque rating 10.6 in. lbs. (1.2 Nm).

**Subbase & Manifold Valve Products
“V” & “P” Series**

“P” Series Peripheral Modules

Peripheral Modules are available and can be mounted directly to valves or used as a stand alone product. These modules answer the complementary needs of the cylinders, flow controls, pressure regulation or positioning.



Flow Control



Pressure Regulator



Dual P.O. Check Valve



Vacuum Generator

D	Subbase & Manual Valves
	H Series Micro
Modurflex Series	
H Series ISO	
Network Connectivity	
DX ISOMAX Series	
Valvair II Series	



For inventory, lead times, and kit lookup, visit www.pdnplu.com

Valve Function

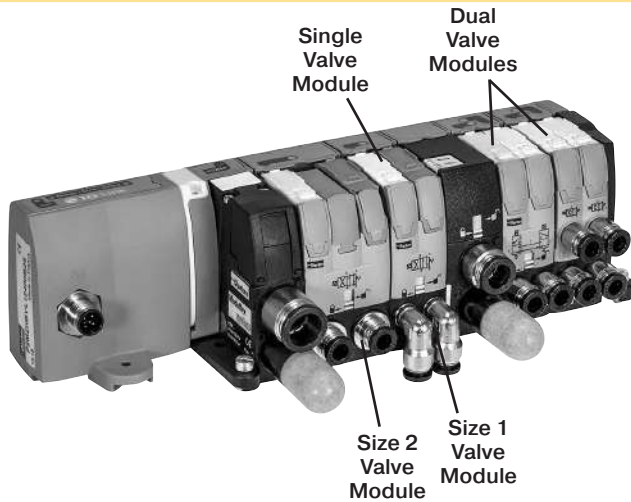

Modulflex Valve Islands offer the greatest flexibility for your design requirements.

Valve Modules are available as 4-Way or 3-Way valves and can be ordered as single or dual valves. A Single Valve Module has one valve in one valve body. A Dual Valve Module will have 2 valves in one valve body. Each Valve in the Dual Valve Body is controlled by a solenoid or air pilot and can be operated independently from the other valve in the same body. There are no dimensional difference between a single and a dual valve. Flow Rates are reduced on the dual valves.

Single valve modules offer Ceramic Slide Valve Technology while dual valve modules offer WCS – Wear Compensation System Technology. Both offer low friction shift forces, fast response and less spool wear.

Valve Modules are available in two different valve body sizes. Size 1 and Size 2 Valve Modules can be combined in both “T” and “V” Series Valve Islands without transition kits.

4/2, 4-Way, 2-Position Valves

Single Valves	ANSI Symbol	Description	Size 1 Body	Size 2 Body
		Single Solenoid, Spring Return Valve	Cv = .32	Cv = .80
		Single Air Pilot, Spring Return Valve		
		Double Solenoid Valve	Cv = .32	Cv = .80
		Double Air Pilot Valve		
Dual Valves	ANSI Symbol	Description	Size 1 Body	Size 2 Body
		(2) Single Solenoid, Spring Return Valve with Exhaust Check. Double Solenoid Valve Body	Cv = .18	N/A
		(2) Single Air Pilot, Spring Return Valve with Exhaust Check. Double Air Pilot Valve Body		

D

Subbase & Manual Valves

H Series Micro

Modulflex Series

H Series ISO

Network Connectivity

DX ISOMAX Series

Valvair II Series





For inventory, lead times, and kit lookup, visit www.pdnplu.com

D29

Parker Hannifin Corporation
 Pneumatic Division
 Richland, Michigan
www.parker.com/pneumatics

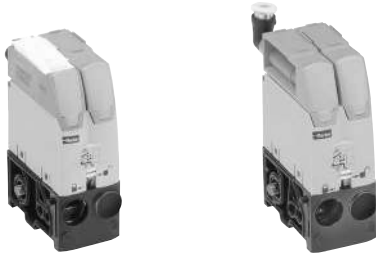
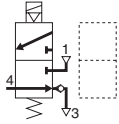
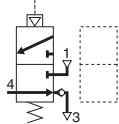
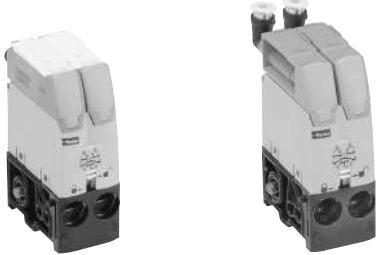
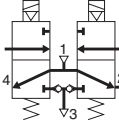
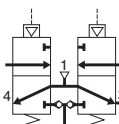
3/2, 3-Way, 2-Position Valves

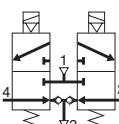
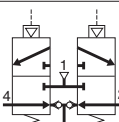
Single Valves	ANSI Symbol	Description	Size 1 Body	Size 2 Body
		Single Solenoid, NC, Spring Return Valve with Exhaust Check.	Cv = .22	Cv = .44
		Single Air Pilot, NC, Spring Return Valve with Exhaust Check.		
Dual Valves	ANSI Symbol	Description	Size 1 Body	Size 2 Body
		(2) Single Solenoid, NO, Spring Return Valve with Exhaust Check. Double Solenoid Valve Body	Cv = .22	Cv = .44
		(2) Single Air Pilot, NO, Spring Return Valve with Exhaust Check. Double Air Pilot Valve Body		
		(2) Single Solenoid, NC, Spring Return Valve with Exhaust Check. Double Solenoid Valve Body	Cv = .22	Cv = .44
		(2) Single Air Pilot, NC, Spring Return Valve with Exhaust Check. Double Air Pilot Valve Body		

D
 Subbase & Manual Valves
 H Series Micro
 Moduflex Series
 H Series ISO
 Network Connectivity
 DX ISOMAX Series
 Valvair II Series

Dual 3/2 Valves Replace All 3-Position Valves for a Better Performance

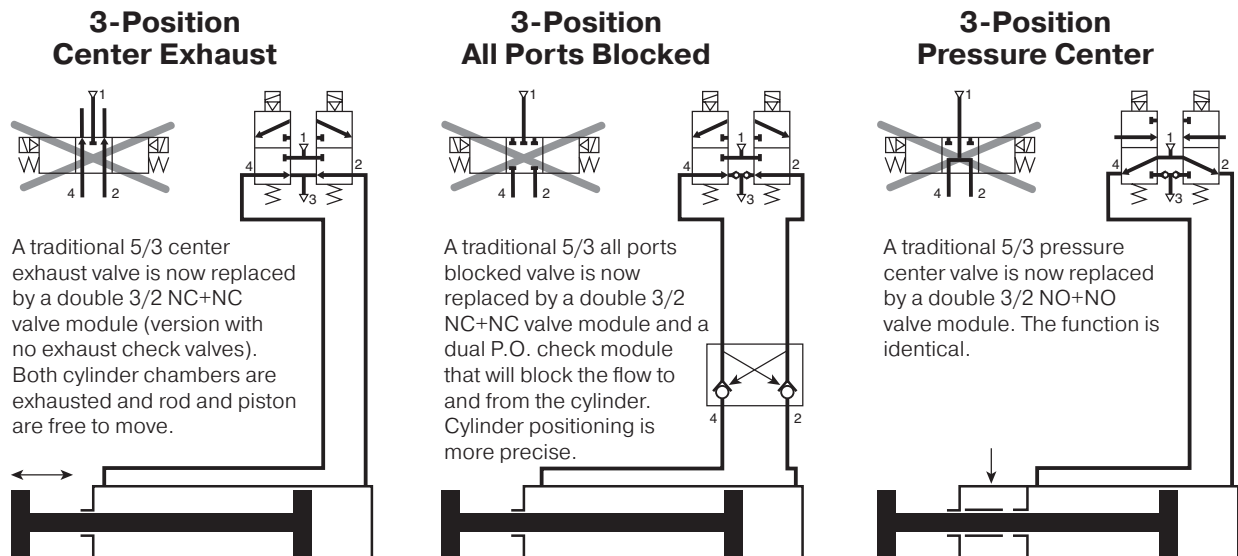











For inventory, lead times, and kit lookup, visit www.pdnplu.com

D30

Parker Hannifin Corporation
 Pneumatic Division
 Richland, Michigan
www.parker.com/pneumatics

"S" Series Individual Subbase Valves (Valve & Base without Pneumatic Connectors)

	Symbol	Type	Operator	Pilot Connector	Cv	Part Number	
						Size 1	Size 2
 Single Solenoid		4-way, 2-position	Single solenoid	M8 Lockable	0.32	P2M1S4ES2C	P2M2S4ES2C
				Clip		P2M1S4ES2CW	0.8
			Single air pilot			P2M1S4PS	P2M2S4PS
		4-way, 2-position	Double solenoid	M8 Lockable	0.32	P2M1S4EE2C	P2M2S4EE2C
				Clip		P2M1S4EE2CW	0.8
			Double air pilot			P2M1S4PP	P2M2S4PP
 Double Solenoid		3-way, 2-position, dual valve, NC/NC w/ exhaust check	Double solenoid	M8 Lockable	0.22	P2M1SDEE2C	P2M2SDEE2C
				Clip		P2M1SDEE2CW	0.44
			Double air pilot			P2M1SDPP	P2M2SDPP
		3-way, 2-position, dual valve, NO/NO w/ exhaust check	Double solenoid	M8 Lockable	0.22	P2M1SCEE2C	P2M2SCEE2C
				Clip		P2M1SCEE2CW	0.44
			Double air pilot			P2M1SCPP	P2M2SCPP
 Single Air Pilot		3-way, 2-position, dual valve, NC/NO w/ exhaust check	Double solenoid	M8 Lockable	0.22	P2M1SEEE2C	P2M2SEEE2C
				Clip		P2M1SEEE2CW	0.44
		3-way, 2-position, NC w/ exhaust check	Single solenoid	M8 Lockable	0.22	P2M1S3ES2C	P2M2S3ES2C
				Clip		P2M1S3ES2CW	0.44
			Single air pilot			P2M1S3PS	P2M2S3PS
			3-way, 2-position, dual valve, NC/NC	Double solenoid	M8 Lockable	0.22	P2M1SGEE2C
			Clip	P2M1SGEE2CW	0.44		P2M2SGEE2CW

Note: Includes 5/32" (4mm) Air Pilot Connectors.



M8 2-pin, male connector

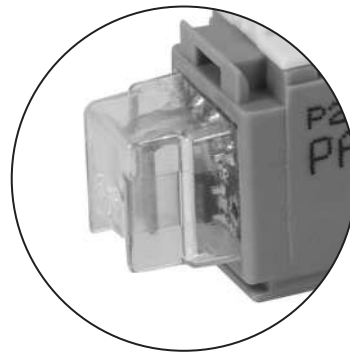

Clip Connector with LED & surge protection

 Most popular.



For inventory, lead times, and kit lookup, visit www.pdnplu.com

D31

Parker Hannifin Corporation
Pneumatic Division
Richland, Michigan
www.parker.com/pneumatics

D

Subbase & Manual Valves

H Series Micro

Moduflex Series







H Series ISO

Network Connectivity

DX ISOMAX Series

Valvair II Series

"S" Series Accessories

Description	Tube Size (OD)	Option	Part Number	Part Number
			Size 1	Size 2
 Push to connect fitting	5/32"	Elbow	CMD04-1	--
		Straight	FMD04-1	--
	1/4"	Elbow	CMD07-1B	CMD07-2B
		Straight	FMD07-1B	FMD07-2B
	3/8"	Elbow	--	CMD09-2B
		Straight	--	FMD09-2B
	1/2"	Straight	--	FMD13-2B
	6mm	Elbow	CMD06-1	CMD06-2
		Straight	FMD06-1	FMD06-2
	8mm	Elbow	--	CMD08-2
		Straight	--	FMD08-2
	10mm	Elbow	--	CMD10-2
Straight		--	FMD10-2	
 Muffler for exhaust port			MMDVA1	MMDVA2
 Plug			--	PMDYY2
 Double male union		Connecting peripheral modules	HMDXX1	HMDXX2
 M8 female connector to flying lead - IP67 LED and surge protection		2m Cable	P8LS08L226C	P8LS08L226C
		5m Cable	P8LS08L526C	P8LS08L526C
		9m Cable	P8LS08L926C	P8LS08L926C
 Clip connector – IP40 Individual: including 2 flying leads Multiple: 1 common (0 VDC) and 1 flying lead per connector	1 x Clip connector	1 meter	P8LW021C	P8LW021C
	2 x Clip connector	1 meter	P8LW021C02	P8LW021C02
	4 x Clip connector	1 meter	P8LW021C04	P8LW021C04
	8 x Clip connector	1 meter	P8LW021C08	P8LW021C08
 Field wireable connector		M8 Connector	P8CS0803J	P8CS0803J
		M12 Connector	P8CS1204J	P8CS1204J

Note: 85 Durometer minimum for pneumatic connectors.

 Most popular.

D

Subbase & Manual Valves

H Series Micro

Moduflex Series

H Series ISO

Network Connectivity

DX ISOMAX Series

Valvair II Series



For inventory, lead times, and kit lookup, visit www.pdnplu.com

**"S" Series Individual Subbase Valve
 (Complete with Pneumatic and Electrical Connectors)**

P2M 1 S 4ES 2C 00 A F4

Basic Series	
Moduflex	P2M

Size	
Size 1	1
Size 2	2

Valve Series	
Individual Subbase	S

Valve Type / Function		
3-Way / 2-Position		
Single Solenoid, Nc Spring Return		3ES
Single Air Pilot, Nc Spring Return		3PS
4-Way / 2-Position		
Single Solenoid, Spring Return		4ES
Single Air Pilot, Spring Return		4PS
Double Solenoid		4EE
Double Air Pilot		4PP
Dual 3-Way, 2-Position, Spring Return		
Solenoid, NC / NC + PO Check (4/3 APB)		BEE*
Air Pilot, NC / NC + PO Check (4/3 APB)		BPP*
Solenoid, NO / NO (4/3 Pressure Ctr.)		CEE
Air pilot NO / NO (4/3 Pressure Ctr.)		CPP
Solenoid, NC / NC with Exhaust Check		DEE
Air Pilot, NC / NC with Exhaust Check		DPP
Solenoid, NO / NC with Exhaust Check		EEE
Solenoid, NC / NC without Check (4/3 Exh. Ctr.)		GEE

Ports (all ports)	
C0*	10mm Elbow Fitting
C4	5/32" (4mm) Elbow Fitting
C6	6mm Elbow Fitting
C7	1/4" Elbow Fitting
C8*	8mm Elbow Fitting
C9*	3/8" Elbow Fitting
F0*	10mm Straight Fitting
F3*	1/2" Straight Fitting
F4	5/32" (4mm) Straight Fitting
F6	6mm Straight Fitting
F7	1/4" Straight Fitting
F8*	8mm Straight Fitting
F9*	3/8" Straight Fitting

* Only available with size 2 valves.

Fitting Configuration	
A*	Straight Fittings
B*	Elbow Fittings
C*	Straight Fitting & Muffler
D*	Elbow Fitting & Muffler

* Ports 1 & 3 fittings sizes are same as ports 2 & 4 (see example at left.)

† Fitting in port 1, muffler in port 3.

Example for fitting configuration:

Size 1

CF7 Ports 1 & 3
 1/4" straight fitting & muffler
 Ports 2 & 4
 1/4" straight fittings

Size 2

AC0 Ports 1 & 3
 10mm elbow fittings
 Ports 2 & 4
 10mm elbow fittings

Operator Voltage	
24VDC	2C
Remote Pilot - 5/32" (4mm) Tube	00

* Valve includes peripheral P. O. Check Valve and union fittings.

LED / Cable	
00	No Cable, No LED, No Surge Suppression
V2	2 Meter Cable with LED and Surge Suppression
V5	5 Meter Cable with LED and Surge Suppression
V9	9 Meter Cable with LED and Surge Suppression
W0	No Cable / Clip Ready
W1	1 Meter Cable, Clip Connector

With only one universal solenoid pilot for all configurations

24VDC is now a global standard for all machines.

The Moduflex 24VDC unique solenoid pilot is supplied with the multi-function manual override that can be adapted to all requirements, as explained by the drawings.

Multi-function adaptable manual override

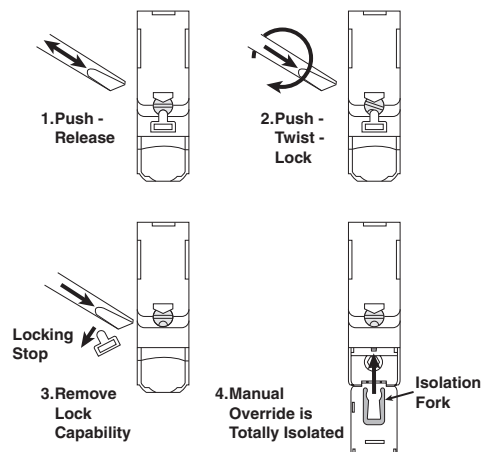

Most popular.



For inventory, lead times, and kit lookup, visit www.pdnplu.com

D33

Parker Hannifin Corporation
 Pneumatic Division
 Richland, Michigan
www.parker.com/pneumatics

D

Subbase & Manual Valves

H Series Micro

Moduflex Series

H Series ISO

Network Connectivity

DX ISOMAX Series

Valvair II Series



Example:

Size 1, 4-Way Single Solenoid valve with 1/4" Straight Connectors in Ports 1, 2 and 4. Exhaust Muffler in Port 3. Valve to include 2m cable with LED and surge suppression.

“S” Series Single Solenoid

How to Order Complete Valve Assembly

Line Item	Quantity	Part Number	Description
1	1	P2M1S4ES2CV2CF7	Size 1, Individual Subbase Valve, 4 Way, Single Solenoid, 2m Cable with LED / Surge Suppression, Exhaust Muffler with 1/4" OD Straight Port Fittings

Notes:

1. Cables supplied loose with valve.
2. For LED and Surge Suppressor, cable must be supplied with valve.

How to Order Components











Line Item	Quantity	Part Number	Description
1	1	P2M1S4ES2C	Size 1, Individual Subbase Valve, Single Solenoid, 4 Way
2	1	P8LS08L226C	2m Cable with LED / Surge Suppression
3	3	FMD07-1B	Size 1, 1/4" OD Tube Push In Connector
4	1	MMDVA1	Size 1, Muffler for Exhaust Port

D
 Subbase & Manual Valves
 H Series Micro
 Moduflex Series
 H Series ISO
 Network Connectivity
 DX ISOMAX Series
 Valvair II Series



For inventory, lead times, and kit lookup, visit www.pdnplu.com

"T" Series Manifold Valves with Individual Connectors

	Symbol	Type	Operator	Pilot Connector	Cv	Part Number		
						Size 1	Size 2	
 Single Solenoid		4-way, 2-position	Single solenoid	M8 Lockable	0.32	P2M1T4ES2C	P2M2T4ES2C	
				Clip		P2M1T4ES2CW	0.8	P2M2T4ES2CW
			Single air pilot			P2M1T4PS		P2M2T4PS
		4-way, 2-position	Double solenoid	M8 Lockable	0.32	P2M1T4EE2C	P2M2T4EE2C	
				Clip		P2M1T4EE2CW	0.8	P2M2T4EE2CW
			Double air pilot			P2M1T4PP		P2M2T4PP
 Double Solenoid		4-way, 2-position, dual valve w/ exhaust check	Double solenoid	M8 Lockable	0.18	P2M1TJEE2C	--	
				Clip		P2M1TJEE2CW	--	--
			Double air pilot			P2M1TJPP	--	--
		3-way, 2-position, dual valve, NC/NC w/ exhaust check	Double solenoid	M8 Lockable	0.22	P2M1TDEE2C	P2M2TDEE2C	
				Clip		P2M1TDEE2CW	0.44	P2M2TDEE2CW
			Double air pilot			P2M1TDPP		P2M2TDPP
 Single Air Pilot		3-way, 2-position, dual valve, NO/NO w/ exhaust check	Double solenoid	M8 Lockable	0.22	P2M1TC EE2C	P2M2TC EE2C	
				Clip		P2M1TC EE2CW	0.44	P2M2TC EE2CW
			Double air pilot			P2M1TCPP		P2M2TCPP
		3-way, 2-position, dual valve, NC/NO w/ exhaust check	Double solenoid	M8 Lockable	0.22	P2M1TEEE2C	P2M2TEEE2C	
				Clip		P2M1TEEE2CW	0.44	P2M2TEEE2CW
			Single solenoid	M8 Lockable		P2M1T3ES2C		P2M2T3ES2C
	3-way, 2-position, dual valve, NC/NC	Double solenoid	M8 Lockable	0.22	P2M1TGEE2C	P2M2TGEE2C		
			Clip		P2M1TGEE2CW	0.44	P2M2TGEE2CW	
		Single air pilot			P2M1T3PS		P2M2T3PS	

Note: Includes 5/32" (4mm) Air Pilot Connectors.

Manifold Options

Module	Part Number
Pneumatic end plate kit	P2M2HXT01*
Pneumatic end plate kit with torx screwdriver	P2M2HXT0T*
Intermediate supply module (Includes 4 configuration plates)	P2M2BXT0A*

* Use Fittings for Size 2 Modules Only



P2M2HXT01



P2M2BXT0A



M8 2-pin, male connector

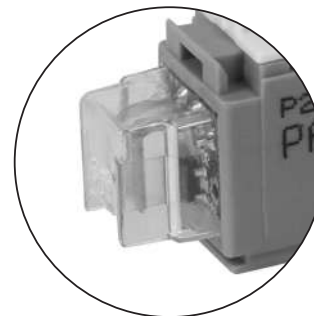

Clip Connector with LED & surge protection

 Most popular.



For inventory, lead times, and kit lookup, visit www.pdnplu.com

D35

Parker Hannifin Corporation
Pneumatic Division
Richland, Michigan
www.parker.com/pneumatics

D

Subbase & Manual Valves

H Series Micro

Moduflex Series









H Series ISO

Network Connectivity

DX ISOMAX Series

Valvair II Series

“T” Series Size Accessories

Description	Tube Size OD	Option	Part Number	Part Number
			Size 1	Size 2
 Push to connect fitting	5/32" or 4mm	Elbow	CMD04-1	--
		Straight	FMD04-1	--
	1/4"	Elbow	CMD07-1B	CMD07-2B
		Straight	FMD07-1B	FMD07-2B
	3/8"	Elbow	--	CMD09-2B
		Straight	--	FMD09-2B
	1/2"	Straight	--	FMD13-2B
	6mm	Elbow	CMD06-1	CMD06-2
		Straight	FMD06-1	FMD06-2
	8mm	Elbow	--	CMD08-2
		Straight	--	FMD08-2
	10mm	Elbow	--	CMD10-2
Straight		--	FMD10-2	
12mm	Elbow	--	CMD12-2 **	
	Straight	--	FMD12-2 **	
 Muffler for exhaust port			MMDVA1	MMDVA2
 Plug			PMDYY1	PMDYY2
 Double male union		Connecting peripheral modules	HMDXX1	HMDXX2
 M8 female connector to flying lead - IP67 LED and surge protection		2M cable	P8LS08L226C	P8LS08L226C
		5M cable	P8LS08L526C	P8LS08L526C
		9M cable	P8LS08L926C	P8LS08L926C
 Clip connector – IP40 Individual: including 2 flying leads Multiple: 1 common (0 VDC) and 1 flying lead per connector	1 x Clip connector	1 meter	P8LW021C	P8LW021C
	2 x Clip connector	1 meter	P8LW021C02	P8LW021C02
	4 x Clip connector	1 meter	P8LW021C04	P8LW021C04
	8 x Clip connector	1 meter	P8LW021C08	P8LW021C08
 Field wireable connector		M8 connector	P8CS0803J	P8CS0803J
		M12 connector	P8CS1204J	P8CS1204J
 Torx screwdriver			P2M1K0TASD	P2M1K0TASD

Note: 85 Durometer minimum for pneumatic connectors.

** 12mm OD fittings can not be used with valves. 12mm OD fittings can only be used in pneumatic end plate kit and intermediate air supply module.

D

Subbase & Manual Valves

H Series Micro

Moduflex Series

H Series ISO

Network Connectivity

DX ISOMAX Series

Valvair II Series

 Most popular.



For inventory, lead times, and kit lookup, visit www.pdnplu.com

D36

Parker Hannifin Corporation
 Pneumatic Division
 Richland, Michigan
www.parker.com/pneumatics

"T" Series Valve Manifold with Individual Connectors
(Complete with Pneumatic and Electrical Connectors)

P2M 1 T 4ES 2C 00 0 F4

Basic Series	
Valvetronic Modules	P2M

Size	
Size 1	1
Size 2	2

Valve Series	
Individual Wire	T

Valve Type / Function	
3-Way / 2-Position	
Single Solenoid, NC Spring Return	3ES
Single Air Pilot, NC Spring Return	3PS
4-Way / 2-Position	
Single Solenoid, Spring Return	4es
Single Air Pilot, Spring Return	4ps
Double Solenoid	4ee
Double Air Pilot	4pp
Dual 3-Way, 2-Position, Spring Return	
Solenoid, NC / NC + PO Check (4/3 APB)	BEE*
Air Pilot, NC / NC + PO Check (4/3 APB)	BPP*
Solenoid, NO / NO (4/3 Pressure Ctr.)	CEE
Air Pilot NO / NO (4/3 Pressure Ctr.)	CPP
Solenoid, NC / NC with Exhaust Check	DEE
Air Pilot, NC / NC with Exhaust Check	DPP
Solenoid, NO / NC with Exhaust Check	EEE
Solenoid, NC / NC without Check (4/3 Exh. Ctr.)	GEE
Dual 4-Way, 2-Position, Spring Return	
Solenoid	JEE**
Air Pilot	JPP**

* Valve includes peripheral P. O. check valve and union fittings.
 ** Size 1 only.

Ports 2 & 4	
C0*	10mm Elbow Fitting
C4	5/32" (4mm) Elbow Fitting
C6	6mm Elbow Fitting
C7	1/4" Elbow Fitting
C8*	8mm Elbow Fitting
C9*	3/8" Elbow Fitting
F0*	10mm Straight Fitting
F3*	1/2" Straight Fitting
F4	5/32" (4mm) Straight Fitting
F6	6mm Straight Fitting
F7	1/4" Straight Fitting
F8*	8mm Straight Fitting
F9*	3/8" Straight Fitting

* Only available with size 2 valves.

Ports 1 & 3	
0	None

LED / Cable	
00	No Cable, no LED, no Surge Suppression
V2	2 Meter Cable with LED and Surge Suppression
V5	5 Meter Cable with LED and Surge Suppression
V9	9 Meter Cable with LED and Surge Suppression
W0	No Cable / Clip Ready
W1	1 Meter Cable, Clip Connector

Operator Voltage	
2C	24VDC
00	Remote Pilot - 5/32" (4mm) Tube

With only one universal solenoid pilot for all configurations

24VDC is now a global standard for all machines.

The Moduflex 24VDC unique solenoid pilot is supplied with the multi-function manual override that can be adapted to all requirements, as explained by the drawings.

Multi-function adaptable manual override

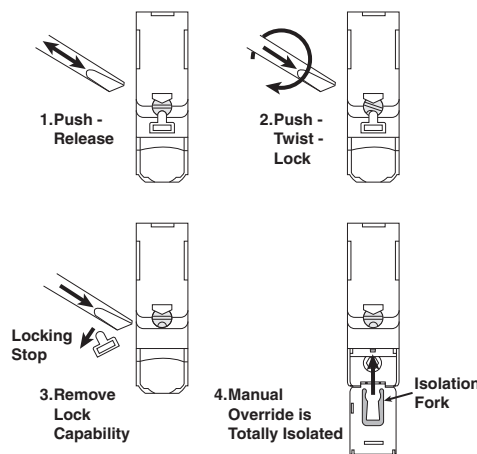

Most popular.



For inventory, lead times, and kit lookup, visit www.pdnplu.com

D37

Parker Hannifin Corporation
 Pneumatic Division
 Richland, Michigan
www.parker.com/pneumatics

D

Subbase & Manual Valves

H Series Micro

Moduflex Series

H Series ISO

Network Connectivity

DX ISOMAX Series

Valvair II Series

Ordering Information

Subbase & Manifold Valve Products Moduflex "T" Series



Example:

Size 1, 4-Way Single Solenoid valve with 1/4" Straight Connectors in Ports 2 and 4. Valve to include 2m cable with LED and surge suppression.

"T" Series Single Solenoid

How to Order Complete Valve Assembly

Line Item	Quantity	Part Number	Description
1	1	P2M1T4ES2CV20F7	Size 1, T Series Manifold Valves, 4 Way, Single Solenoid, 2m Cable with LED / Surge Suppression, 1/4" OD Straight Port Fittings

Notes:

1. Cables supplied loose with valve.
2. For LED and Surge Suppressor, cable must be supplied with valve.
3. To assemble into a manifold, Pneumatic Head and Tail Set must be ordered separately.

How to Order Components

Line Item	Quantity	Part Number	Description
1	1	P2M1T4ES2C	Size 1, T Series Manifold Valves, Single Solenoid, 4 Way
2	1	P8LS08L226C	2m Cable with LED / Surge Suppression
3	2	FMD07-1B	Size 1, 1/4" OD Tube Push In Connector

D

Subbase & Manual
Valves

H Series
Micro

Moduflex
Series

H Series
ISO

Network
Connectivity

DX ISOMAX
Series

Valvair II
Series













For inventory, lead times, and kit lookup, visit www.pdnplu.com

D38

Parker Hannifin Corporation
Pneumatic Division
Richland, Michigan
www.parker.com/pneumatics

“V” Series Manifold Valves with Collective Wiring

	Symbol	Type	Operator	Cv	Part Number		Part Number	
					Size 1	Cv	Size 2	
 <p>Single Solenoid</p>		4-way, 2-position	Single solenoid	0.32	P2M1V4ES2CV	0.8	P2M2V4ES2CV	
		4-way, 2-position	Double solenoid	0.32	P2M1V4EE2CV	0.8	P2M2V4EE2CV	
		4-way, 2-position, dual valve, w/ exhaust check	Double solenoid	0.18	P2M1VJEE2CV			
		3-way, 2-position, dual valve, NC/NC w/ exhaust check	Double solenoid	0.22	P2M1VDEE2CV	0.44	P2M2VDEE2CV	
 <p>Double Solenoid</p>		3-way, 2-position, dual valve, NO/NO w/ exhaust check	Double solenoid	0.22	P2M1VCEE2CV	0.44	P2M2VCEE2CV	
		3-way, 2-position, dual valve, NC/NO w/ exhaust check	Double solenoid	0.22	P2M1VEEE2CV	0.44	P2M2VEEE2CV	
		3-way, 2-position, NC w/ exhaust check	Single solenoid	0.22	P2M1V3ES2CV	0.44	P2M2V3ES2CV	
		3-way, 2-position, dual valve, NC/NC	Double solenoid	0.22	P2M1VGEE2CV	0.44	P2M2VGEE2CV	

 Most popular.



For inventory, lead times, and kit lookup, visit www.pdnplu.com

D

Subbase & Manual Valves

H Series Micro

Moduflex Series

H Series ISO

Network Connectivity

DX ISOMAX Series

Valvair II Series

“V” Series Accessories

	Description	Tube size OD	Option	Part Number	
				Size 1	Size 2
	Push to connect fitting	5/32"	Elbow	CMD04-1	–
			Straight	FMD04-1	–
	1/4"	Elbow	CMD07-1B	CMD07-2B	
		Straight	FMD07-1B	FMD07-2B	
	3/8"	Elbow	–	CMD09-2B	
		Straight	–	FMD09-2B	
	1/2"	Straight	–	FMD13-2B	
	6mm	Elbow	CMD06-1	CMD06-2	
		Straight	FMD06-1	FMD06-2	
	8mm	Elbow	–	CMD08-2	
		Straight	–	FMD08-2	
	10mm	Elbow	–	CMD10-2	
		Straight	–	FMD10-2	
	12mm	Elbow	–	CMD12-2 **	
Straight		–	FMD12-2 **		
	Muffler for exhaust port		--	MMDVA1	MMDVA2
	Plug		--	PMDYY1	PMDYY2
	Double male union		Connecting peripheral modules	HMDXX1	HMDXX2
	Electrical 20-pin multi-connector cable with flying leads	IP65 rated	2M cable	P8LMH20M2A	P8LMH20M2A
			5M cable	P8LMH20M5A	P8LMH20M5A
			9M cable	P8LMH20M9A	P8LMH20M9A
	Electrical 25-pin D-sub cable	IP20 rated	3M cable	P8LMH25M3A	P8LMH25M3A
			9M cable	SCD259D	SCD259D
		IP65 rated	3M cable	SCD253W	SCD253W
9M cable	SCD259WE		SCD259WE		
	Field wireable connector for power supply	Female	M12 - A code	P8CS1205AA	
	Power & Communication Cable	IO-Link	5-pin male to female cable, TPE	RKC 4.5T- *-RSC 4.5T/S1587	
	Torx screwdriver		--	P2M1K0TASD	P2M1K0TASD

Where * = 1, 2, 3, 4, 5, 10, 20 meter standard lengths

Note: 85 Durometer minimum for pneumatic connectors.

** 12mm OD fittings can not be used with valves. 12mm OD fittings can only be used in pneumatic end plate kit and intermediate air supply module.

D

Subbase & Manual Valves

H Series Micro

Moduflex Series

H Series ISO

Network Connectivity

DX ISOMAX Series

Valvair II Series



For inventory, lead times, and kit lookup, visit www.pdnplu.com

Electrical Connections

Description	Part Number
20-pin, Multi-connector electrical head module	P2M2HEV0A
25-pin, D-sub, electrical head module	P2M2HEV0D



P2M2HEV0A



P2M2HEV0D

Network Connectivity Connections

Description	Part Number	
EtherNet I/P	P2M2HBVE12400	
PROFINET	P2M2HBVN12400	
EtherCAT	P2M2HBVT12400	
Modbus TCP	P2M2HBVM12400	
PowerLink	P2M2HBVW12400	
IO-Link Class A	3-Pin, Aux power 1 & 3	P2M2HBVL12400A13
IO-Link Class A	3-Pin, Aux power 4 & 3	P2M2HBVL12400A43
IO-Link Class A	3-Pin, Aux power 4 & 2	P2M2HBVL12400A42
IO-Link Class B	5-Pin, Aux power 2 & 5	P2M2HBVL12400B25

Manifold Options

Module	Part Number
Pneumatic end plate kit	P2M2HXT01*
Pneumatic end plate kit with torx screwdriver	P2M2HXT0T*
Intermediate supply module (Includes 4 configuration plates)	P2M2BXV0A*

* Use Fittings for Size 2 Modules Only



P2M2HXT01

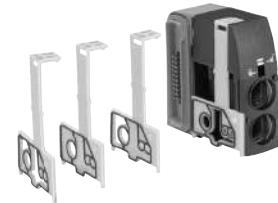

P2M2BXV0A

Most popular.



For inventory, lead times, and kit lookup, visit www.pdnplu.com

D41

Parker Hannifin Corporation
 Pneumatic Division
 Richland, Michigan
www.parker.com/pneumatics

D

Subbase & Manual Valves

H Series Micro

Moduflex Series

H Series ISO

Network Connectivity

DX ISOMAX Series

Valvair II Series

"V" Series Valve Manifold with Collective Wiring
(Complete with Pneumatic Connectors)

P2M 1 V 4ES 2C V0 0 F4

Basic Series	
Valvetronic Modules	P2M

Size	
Size 1	1
Size 2	2

Valve Series	
Collective Wiring	V

Valve Type / Function	
<i>3-Way / 2-Position</i>	
Single Solenoid, NC Spring Return	3ES
<i>4-Way / 2-Position</i>	
Single Solenoid, Spring Return	4es
Double Solenoid	4ee
<i>Dual 3-Way, 2-Position, Spring Return</i>	
Solenoid, NC / NC + PO Check (4/3 APB)	BEE*
Solenoid, NO / NO (4/3 Pressure Ctr.)	CEE
Solenoid, NC / NC with Exhaust Check	DEE
Solenoid, NO / NC with Exhaust Check	EEE
Solenoid, NC / NC without Check (4/3 Exh. Ctr.)	GEE
<i>Dual 4-Way, 2-Position, Spring Return</i>	
Solenoid	JEE**

* Valve includes peripheral P. O. Check valve and union fittings.
** Size 1 Only.

Ports 2 & 4	
C0*	10mm Elbow Fitting
C4	5/32" (4mm) Elbow Fitting
C6	6mm Elbow Fitting
C7	1/4" Elbow Fitting
C8*	8mm Elbow Fitting
C9*	3/8" Elbow Fitting
F0*	10mm Straight Fitting
F3*	1/2" Straight Fitting
F4	5/32" (4mm) Straight Fitting
F6	6mm Straight Fitting
F7	1/4" Straight Fitting
F8*	8mm Straight Fitting
F9*	3/8" Straight Fitting

* Only available with size 2 valves.

Ports 1 & 3	
0	None

LED / Cable	
V0	No Cable with LED and Surge Suppression

Operator Voltage	
2C	24VDC

D
Subbase & Manual Valves

H Series Micro

Moduflex Series

H Series ISO

Network Connectivity

DX ISOMAX Series

Valvair II Series

With only one universal solenoid pilot for all configurations

24VDC is now a global standard for all machines.

The Moduflex 24VDC unique solenoid pilot is supplied with the multi-function manual override that can be adapted to all requirements, as explained by the drawings.

Multi-function adaptable manual override

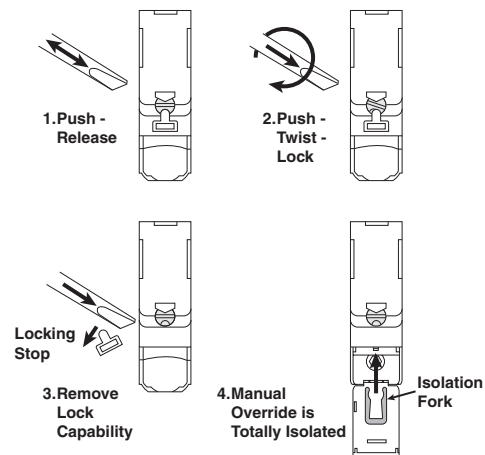

Most popular.



For inventory, lead times, and kit lookup, visit www.pdnplu.com

“V” Series Single Solenoid



How to Order -

Example: Size 1, 4-Way Single Solenoid valve with 1/4" Straight Connectors in Ports 2 and 4. Valve to include LED and surge suppression.

Line Item	Quantity	Part Number	Description
Complete Peripheral Module			
1	1	P2M2V4ES2CV00F7	Size 1, V Series Manifold Valves, 4 Way, Single Solenoid, LED / Surge Suppression, 1/4" OD Straight Port Fittings
Components			
1	1	P2M1V4ES2CV	Size 1, V Series Manifold Valves, Single Solenoid, 4 Way
2	2	FMD07-1B	Size 1, 1/4" OD Tube Push In Connector

D

Subbase & Manual Valves

H Series Micro

Moduflex Series

H Series ISO

Network Connectivity

DX ISOMAX Series

Valvair II Series



For inventory, lead times, and kit lookup, visit www.pdnplu.com

D43

Parker Hannifin Corporation
 Pneumatic Division
 Richland, Michigan
www.parker.com/pneumatics

“V” Series 25-Pin, D-Sub Addressing



Valve Island Head 25-Pin, Multi-Connector

On the island head module, the multi-connector integrates the HE10 connector standard in its 25-Pin version.

Its plug-in function is secured in position with a guillotine lock with easy access from the front of the island.

The 25-Pin, D-Sub multi-connector is rated for IP40.

25-Pin, Multi-Connector Addressing

When assembling a **V Series** island, modules are automatically connected to the head module through the modular principle of the integrated electrical connections.

Each wire color code corresponds a solenoid pilot position in the island.



P8LMH25M3A - Cable

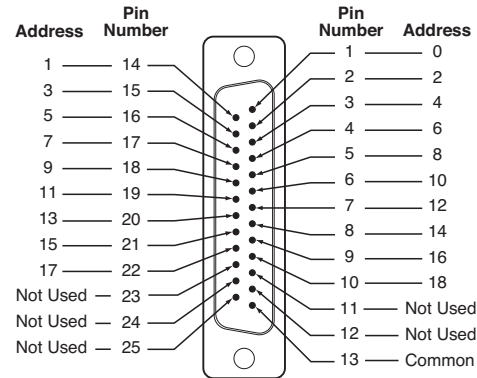

Face View - Male D-Sub, 25-Pin Head Module Connector

Electrical 25-Pin D-Sub Cable

Length (meters)	Weight (oz)	IP	Part Number
3	14.3	20	P8LMH25M3A
3	14.3	65	SCD253W
9	55.8	20	SCD259D
9	55.8	65	SCD259WE

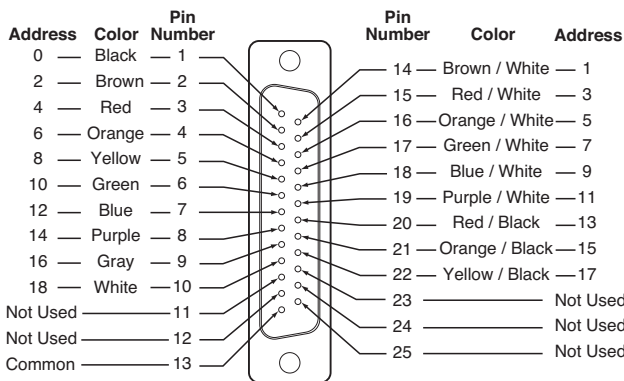

Face View - Female D-Sub, 25-Pin Cable Connector

Electrical Specifications

Rated voltage	24VDC
Maximum addresses	19
Maximum energized simultaneously	19
Electrical connection	25-Pin, D-Sub DIN41652, MIL-C-24308, NFC93425 Type HE5
Polarity	Insensitive: PNP and NPN compatible
Dust and water protection	IP40 / IP65

D
 Subbase & Manual Valves
 H Series Micro
 Moduflex Series
 H Series ISO
 Network Connectivity
 DX ISOMAX Series
 Valvaire II Series



For inventory, lead times, and kit lookup, visit www.pdnplu.com

"V" Series 20-Pin, Multi-Connector and Addressing



Valve Island Head 20-Pin, Multi-Connector

On the island head module, the multi-connector integrates the HE10 connector standard in its 20-Pin version.

Its plug-in function is secured in position with a guillotine lock with easy access from the front of the island.

Just like the whole island, the multi-connector follows the IP65 protection standard.

Cable Specification:

8.6 mm dia., UL, 20 wires, 0.22mm², AWG 24

Minimum Static Radius: 6.5 mm (.255")

Available with 6.56 ft. (2 m), 16.4 ft. (5 m) and 29.5 ft. (9 m) lengths.

20-Pin, Multi-Connector Addressing

When assembling a **V Series** island, modules are automatically connected to the head module through the modular principle of the integrated electrical connections.

The color code addressing given below conforms to the DIN 47100 standard.

Each wire color code corresponds a solenoid pilot position in the island.



P8LMH20M2A - Cable

Electrical 20-Pin Multi-Connector with Flying Lead Cable

Cable Length	Weight (oz)	IP	Part Number
2 m	10.97	65	P8LMH20M2A
5 m	27.41	65	P8LMH20M5A
9 m	49.38	65	P8LMH20M9A

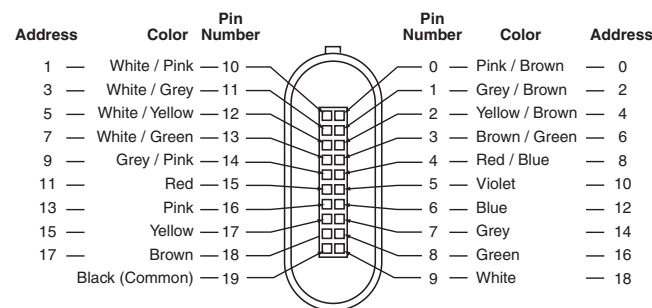

Face View - Female 20-Pin Cable Connector

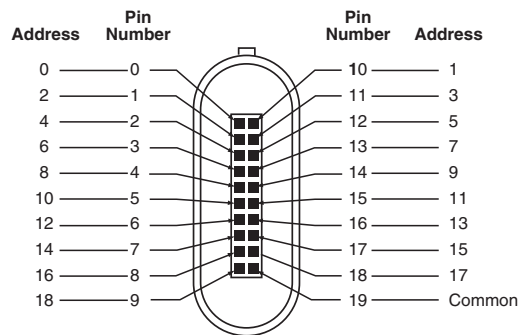

Face View - Male 20-Pin Head Module Connector

Electrical Specifications

Rated Voltage	24VDC
Maximum Addresses	19
Maximum Energized Simultaneously	19
Electrical Connection	Type HE10
Polarity	Insensitive: PNP and NPN compatible
Dust and Water Protection	IP65

D

Subbase & Manual Valves

H Series Micro

Moduflex Series

H Series ISO

Network Connectivity

DX ISOMAX Series

Valvair II Series



For inventory, lead times, and kit lookup, visit www.pdnplu.com

P2M Network Nodes

P2M communication modules directly attach to the Moduflex valve series as well as the P2M endplates of the H Series Micro and H Series ISO valve products. It offers a compact and low cost network solution.

Features

- Small, compact product design
- IO-Link Class A & Class B nodes
- Broad protocol offering
- Channel-level diagnostics (LED and Electronic)
- Horizontal and vertical mounting without derating
- 5g vibration
- Quick-disconnects for I/O and network connectivity
- Built-in panel grounding
- CE certification



D
Subbase & Manual Valves
H Series Micro
Moduflex Series
H Series ISO
Network Connectivity
DX ISOMAX Series
Valvair II Series



For inventory, lead times, and kit lookup, visit www.pdnplu.com

D46

Parker Hannifin Corporation
Pneumatic Division
Richland, Michigan
www.parker.com/pneumatics

P2M Industrial Ethernet Node

The P2M Industrial Ethernet 24 DO node allows a very simple and cost efficient connection to the most popular Industrial Ethernet networks.

Designed with isolated auxiliary power, it can easily be adapted to all power supply architectures and follow any required machine directives as Safe Power Capable.



Industrial Ethernet Protocol	Part Number
EtherNet/IP (Safe Power Capable)	P2M2HBVE12400
PROFINET (Safe Power Capable)	P2M2HBVN12400
EtherCAT (Safe Power Capable)	P2M2HBVT12400
Modbus/TCP (Safe Power Capable)	P2M2HBVM12400
PowerLink (Safe Power Capable)	P2M2HBVW12400

Simple Product Set-Up

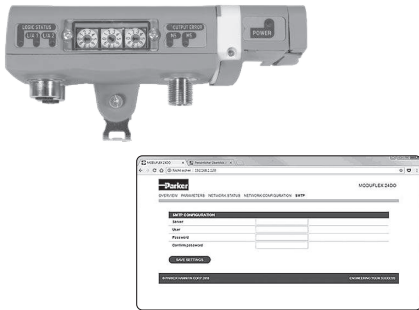

The P2M Industrial Ethernet node offers IP addressing through 3 rotary switches located on the top side.

The 3 rotary switches also allow for Factory Reset, IP address storage, and DHCP addressing.

If supported by the protocol used, the IP address can be modified through the embedded web page.

For an application requiring a regular disconnection / reconnection of communication & power, PROFINET and EtherNet/IP protocols allow respectively a Fast Start-Up (FSU) and Quick Connect mode. This mode can be enabled or disabled.

Topology / Integrated Ethernet Switch

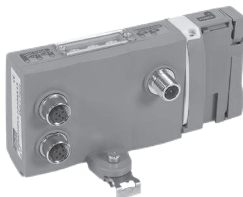

The P2M Industrial Ethernet 24 DO node offers 2 Ethernet ports allowing a line topology without external switch. The Ring topology can also be supported (enable/disable) for PROFINET, EtherNet/IP and Modbus TCP/IP.

The integrated Ethernet switch supports Class C services allowing use in an isochronous real time (IRT) structure.

Easy Diagnostics – Local LEDs, Process (cyclic) data, Parameter (acyclic) data

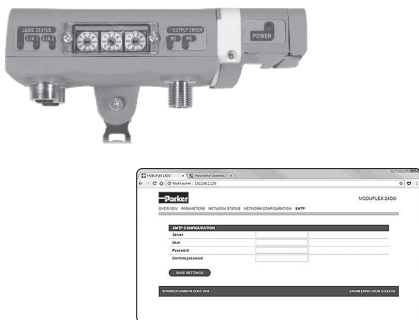

The P2M Industrial Ethernet 24 DO node offers local diagnostics through 7 LED's located on the visible top side, showing:

- Logic status
- Ethernet activity on both ports
- Standard Status due to protocol
- Output error / Auxiliary power

This local information as well as configuration and predictive maintenance diagnostics (Power monitoring, Solenoid cycle counting, etc) are available via both Process Data (cyclic) and Parameter Data (acyclic) via the PLC through the network and also easily viewable from the embedded web page.

When the PLC is NOT in control, the web page allows the user to force ON/OFF the solenoids state. This function has password protection.

P2M Industrial Ethernet Connections & Configuration

Ethernet ports and Auxiliary power connection

Ethernet ports: 2 x Standard Female M12 D-Coded – 5 pins
 Auxiliary Power: Standard Male M12 A-Coded – 4 pins

Configuration file

The configuration files (.EDS, .GDS, etc) can be download from the product web page.

Add on Instructions & Function Blocks

Add on Instructions & Function Blocks to assist in the configuration and programming of the P2M Node are available on the product web page – www.parker.com/pdn/P2M_IE

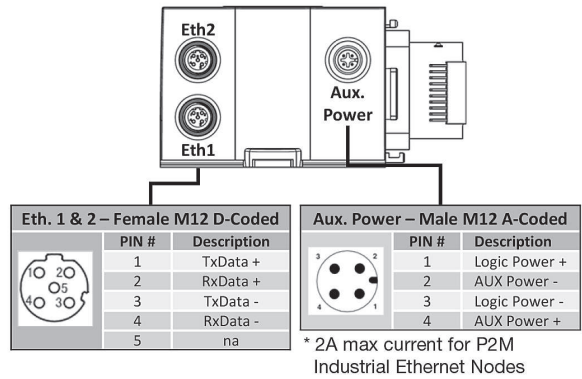

Safe Power Capable

Auxiliary power of P2M Industrial Ethernet 24 DO node can be supplied from a safe output device following machinery directives. This includes:

- Output Signal Switch Device (OSSD) test pulse compatible
- Galvanic isolation between 0 Vdc Logic and Auxiliary power
- PP or PM cabling modes

For more details, refer to the user manuals located at www.parker.com/pdn/P2M_IE

P2M Industrial Ethernet Valve Control

All P2M Industrial Ethernet Nodes can easily connect to and control pneumatic valves sizes ranging from 0.18 Cv to 6.0 Cv utilizing the Moduflex, H Micro, or H ISO valve series including the new H ISO Universal manifold which can mix ISO sizes 15407 (sizes 02 & 01) and 5599 (sizes 1 & 2) without transition plates.

P2M on Moduflex

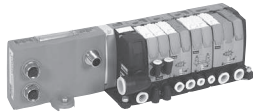

P2M on H Series Micro

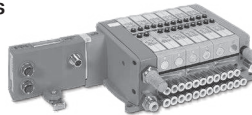

P2M on H Series ISO Universal

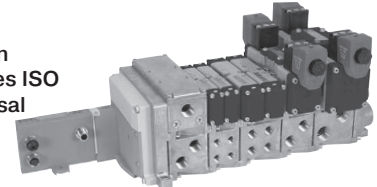

P2M Industrial Ethernet Node Output (Solenoid) data mapping - shown on Moduflex valve series

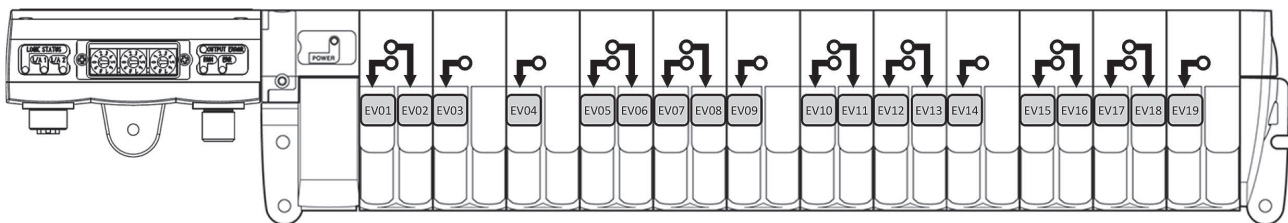

	7 3	2 0
Byte 0	EV08 EV03 EV01
Byte 1	EV16 EV11 EV09
Byte 2*	EV24 EV20	EV19 EV17

* Byte 2 / Bits 3 to 7 are only available when connected to H Series Micro or H Series ISO valve manifolds. The Moduflex valve series is limited to 19.

Process (Cyclic) Diagnostic through network via ADI #9 – “Module Error Input”

Easy to access diagnostic data transmitted to the PLC as Application Device Instance (ADI) #9

- Voltage warning, short circuit condition, module error, etc
- For more details refer to user manual on product web page www.parker.com/pdn/P2M_IE

ADI	Instance name	Data type	Access
#9	Module error input	Unit 16	Read
Byte 0	Diag 7 Diag 0		
Byte 1	Reserved		

D
 Subbase & Manual Valves
 H Series Micro
 Moduflex Series
 H Series ISO
 Network Connectivity
 DX ISOMAX Series
 Valvaire II Series



For inventory, lead times, and kit lookup, visit www.pdnplu.com

Valve Island V Series with Industrial Ethernet connection

The P2M Industrial Ethernet Lite node 24DO allows a very simple and cost efficient connection to the most popular Industrial Ethernet networks.

In its compact IP40 version equipped with two RJ45 Ethernet ports, it saves size in cabinet applications and offers an easy connection to the network in a line topology.

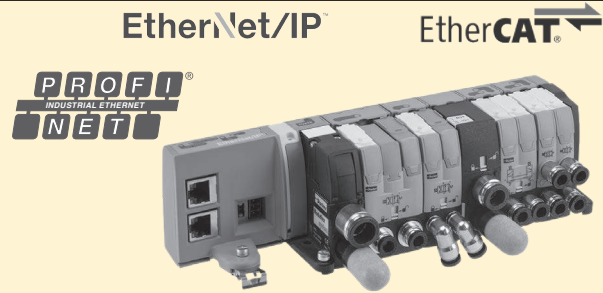

Industrial Ethernet Protocol	Part Number
Profinet IO	P2M2HBVN12400RJ
EtherNet/IP	P2M2HBVE12400RJ
EtherCAT	P2M2HBVT12400RJ

Product Set-Up



The P2M Lite Node 24DO is by default in DHCP mode. The module must be assigned to a static IP-Address in order to be controlled via the network.

The Network Configuration settings can be done through the embedded web server of the node as well as "IPconfig", "TIA Portal" or similar methods.

For an application requiring a regular disconnection / reconnection of the node, Profinet and EtherNet/IP protocols allow respectively a Fast Start-Up (FSU) and Quick Connect mode. This mode can be enable or disable .

Technology / Integrated Ethernet Switch



The P2M Industrial Ethernet Lite node 24DO offers 2 RJ45 ports allowing a line topology without external switch. The Ring topology can also be supported (enable/disable) for Profinet and EtherNet/IP.

The integrated Ethernet switch support Class C Services allowing used in an isochronous real time (IRT) structure.

Diagnostic



The P2M Industrial Ethernet Lite node 24DO offers a local diagnostic through 5 LED's located on the visible top side and 4 additional on both Ethernet connectors showing:

- Logic status
- Ethernet activity on both ports
- Standard Status due to protocol
- Output error / Power Supply

This local information as well as trouble shooting and predictive maintenance diagnostics (Power monitoring, Life cycle counting, ...) are available in PLC through the network and reported on imbedded web page.

When PLC is in "STOP", the web page allows to force ON/OFF solenoids state. This function has a password protection.

Save 1.31 inches with P2M Lite Node compared to P2M Ethernet Node

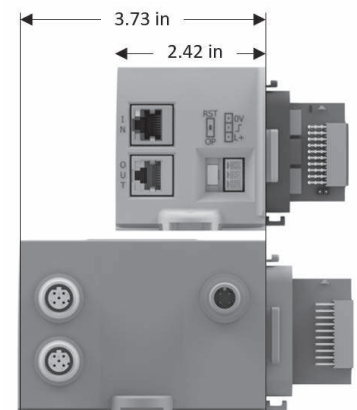

Industrial Ethernet Lite Node Connections and Diagnostic Functions

Ethernet and Power Connections

Network Communication Ports:

2 x Standard RJ45 Female connectors
 Usage of standard manufactured cables available from your usual electrical supplier is recommended.

Power Supply:

Standard 3-Pin Male Connector - 3,81 mm pitch

Working mode selector:

DIP-switch

Configuration Files

The configuration files can be download from the product web page: www.parker.com/pde/P2M_IE

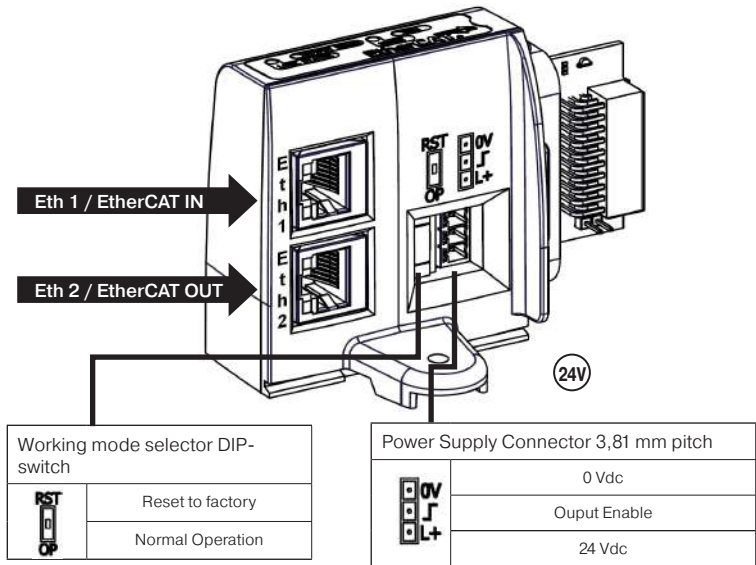

IP Address Setting

For both Profinet IO and EtherNet/IP protocols, the P2M Lite 24DO Node is by default in DHCP mode. The module must be assigned to a static IP-Address in order to be controlled via network. Please, refer to the user manual for IP-Address assignment process.

Local and Network Diagnostic Functions

Local Diagnostic

The P2M Lite 24DO node offers a local diagnostic via 9 LED's. Please refer to user manual with interpretation table.

Network Diagnostic

The P2M Lite 24DO Node offers additional useful module status information:

- Pilot overload or short circuit
- Power Voltage out of tolerance
- Cycle counter for every pilot
- Module temperature

For detailed technical information on the P2M Lite 24DO Node and a complete interpretation of node's diagnostic functionalities, please refer to the User Manual available from the product web page: www.parker.com/pde/P2M_IE

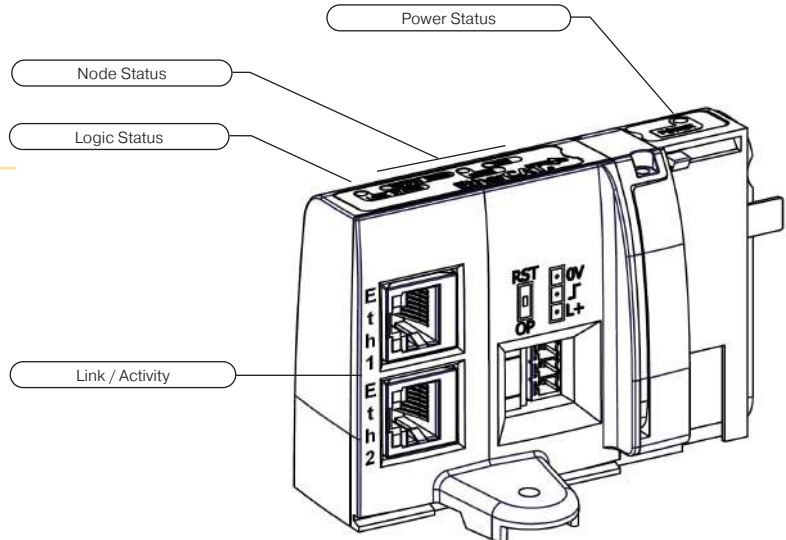

EtherNet/IP™



EtherCAT®

D	Subbase & Manual
	Valves
H Series	Micro
	Modulflex Series
H Series	ISO
	Network Connectivity
DX ISOMAX Series	
	Valvair II Series



For inventory, lead times, and kit lookup, visit www.pdnplu.com

Valve Island V Series with IO-Link connection

The P2M Moduflex IO-Link 24 DO node allows a very simple and cost efficient connection to any IO-Link master, centralised into the PLC or decentralised through an industrial Ethernet network.

Designed in both Class A and Class B versions with an isolated auxiliary power, it can easily be adapted to all power supply architectures and follow machine directives.

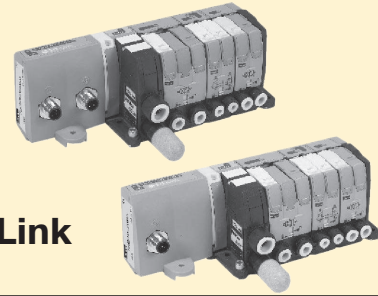

IO-Link

“V” Series Valve Island - P2M head module for IO-Link

Electrical Module for 24 outputs (The last 5 outputs of this 24 DO module can not be used with Moduflex Valve)



M12 A coded Connector connection

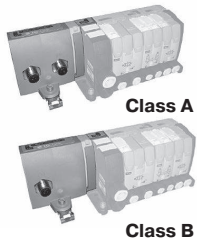

Description	IO-Link class	IO-Link	Aux. power	Aux. power pinout	Weight (g)	Part Number	
						Standard	Safe Power Capable
Class A P2M IO-Link communication module	Class A	3 Pin's	3 Pin's	1 & 3	160	P2M2HBVL12400A13	P2M2HBVL12400A13-SPC
		3 Pin's	3 Pin's	4 & 3	160	P2M2HBVL12400A43	P2M2HBVL12400A43-SPC
		3 Pin's	5 Pin's	4 & 2	160	P2M2HBVL12400A42	P2M2HBVL12400A42-SPC
Class B	Class B	5 Pin's		2 & 5	140	P2M2HBVL12400B25	P2M2HBVL12400B25-SPC
Power & communication cable						RKC 4.5T-* -RSC 4.5T/S1587	

IODD file can be downloaded from IODD Finder or the Moduflex web site:
<https://ioddfinder.io-link.com> or www.parker.com/pdn/io-link

Where * = 1, 2, 3, 4, 5, 10, 20 meter standard lengths

P2M Class A Module with Independent Auxiliary Power Supply

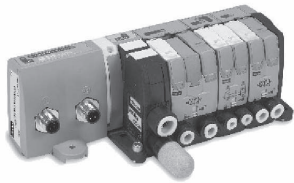

The P2M IO-Link Class A module can handle a Moduflex valve manifold having up to 19 solenoid outputs, or H Series Micro / ISO up to 24 solenoid outputs.

Thanks to its 2 x M12 A coded male connectors, the P2M node can be connected to any IO-Link Class A master and separately receive its auxiliary power supply for valves from an independent source.

The P2M IO-Link Class A module exists in 3 versions with the auxiliary power M12 connector pin out adapted to any sourcing through a standard M12 cable:

- P2M2HBVL12400A13 version: 24Vdc / 0Vdc on pins 1 & 3 – Standard version
- P2M2HBVL12400A43 version: 24Vdc / 0Vdc on pins 4 & 3 – Compatible with Siemens wiring
- P2M2HBVL12400A42 version: 24Vdc / 0Vdc on pins 4 & 2 – Compatible with Rockwell wiring and Turck wiring

P2M Class B Module

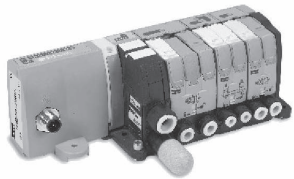

The P2M IO-Link Class B module can handle a Moduflex valve manifold having up to 19 solenoid outputs, or H Series Micro / ISO up to 24 solenoid outputs.

Thanks to its single M12 A coded male connectors, P2M node can be connected to any IO-Link Class B master receiving its auxiliary power supply for valves on pins 2 & 5 from the only cable simplifying the connection.

- P2M2HBVL12400B25 version: 24VDC / 0VDC on pins 2 & 5

Valve Series

Check the total maximum solenoid current consumption against the limit of the power supply and P2M module (standard version 4A, SPC version 2A).



Moduflex Valve
 Cv: .18 - 0.80
 19 Solenoids
 42mA per Sol.



H Micro
 Cv: 0.35
 24 Solenoids
 42mA per Sol.

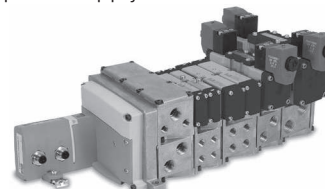

H ISO 15407-2 & 5599-2
 Cv: 0.55 - 6.0
 24 Solenoids
 42mA (15407) / 133mA (5599) per Sol.



For inventory, lead times, and kit lookup, visit www.pdnplu.com

D51

Parker Hannifin Corporation
 Pneumatic Division
 Richland, Michigan
www.parker.com/pneumatics

D

Subbase & Manual Valves

H Series Micro

Moduflex Series

H Series ISO

Network Connectivity

DX ISOMAX Series

Valvair II Series

IO-Link Module Connection and Diagnostic Functions



IO-Link Module Connection

Standard male M12 – type A

Usage of standard manufactured cables available from your usual electrical supplier is recommended.

Note: Auxiliary power for solenoids can be wired allowing the user to turn outputs off while the communications remains on.

Configuration

IODD file can be downloaded from IODD Finder or the P2M web site:

<https://ioddfinder.io-link.com>

www.parker.com/pdn/P2M_IOL

Class B



Class A

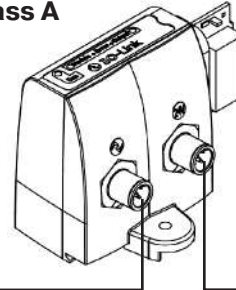

Legend

Symbol	Description
L+	IO-Link power supply "+"
L-	IO-Link power supply "-"
C/Q	IO-Link communication
Aux +	Auxiliary power supply 24 VDC
Aux -	Auxiliary power supply 0 VDC

M12 pin's	Class A		
	3 pin's		5 pin's
	P2M...A13	P2M...A43	P2M...A42
L+	Aux +	Not used	Not used
Aux +	-	-	Aux -
L-	Aux -	Aux -	Not used
C/Q	n.c.	Aux +	Aux +
Aux -	-	-	Not used

Auxiliary Power Supply Compatibility

The P2M IO-Link Node can be powered from a 24VDC auxiliary source in PP or PM mode as grounds are isolated.

The P2M Safe Power Capable (-SPC) versions can be connected from a SAFE OSSD test pulsed power source.

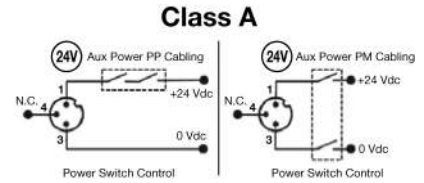
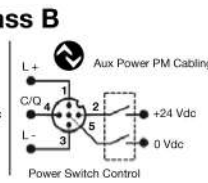
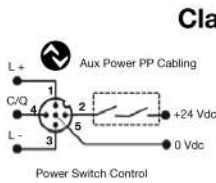

Cabling for P2M2HBVL12400A13

IO-Link Module Diagnostic Functions

The P2M IO-Link module offers additional useful module status information:

- Solenoid overload or short circuit
- Auxiliary voltage out of tolerance
- Cycle counter for each solenoid
- Module temperature

For more information on product technical information and module diagnostic functionalities, please refer to the user manual available from the product web page:

www.parker.com/pdn/P2M_IOL

COM Green LED			Module-Error Red LED			Error-Output Red LED			POWER Green LED		
LED Status	Description	Solving	LED Status	Description	Solving	LED Status	Description	Solving	LED Status	Description	Solving
OFF	IO-Link L+ / L- not powered	Check connection	OFF	Standard mode	NA	OFF	Standard mode	NA	OFF	AUX power failure	Check Auxiliary Power Supply
ON	IOL L+ / L- powered IO mode	Set IO-Link mode in IO-Link master	ON	24 VDC AUX power missing or any active malfunction	Check power supply or change module	ON	Any driver error (overload, over temperature, etc.)	Fix solenoid issue then acknowledge error	ON	Standard	NA
Blinking	IO-Link communication active	NA							Blinking	Aux Power is out of range, alarm level	Check Auxiliary Power Supply

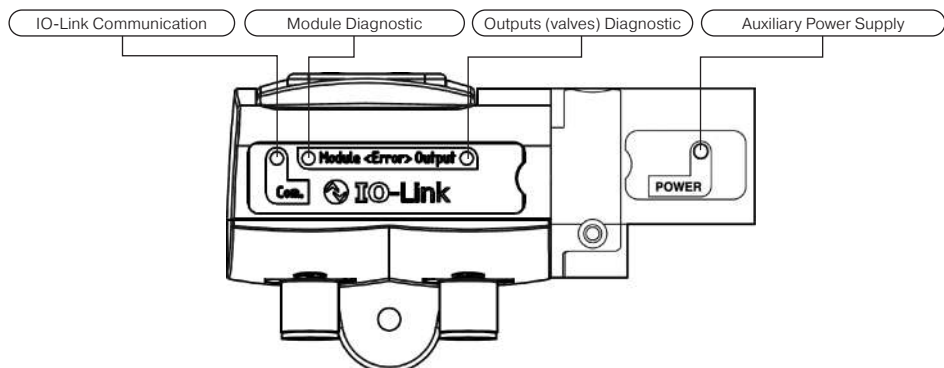

D
 Subbase & Manual Valves
 H Series Micro
 Modulflex Series
 H Series ISO
 Network Connectivity
 DX ISOMAX Series
 Valvaire II Series



For inventory, lead times, and kit lookup, visit www.pdnplu.com

Input Data

One byte of diagnostic input data is transferred from P2M IO-Link to the IO-Link Master.

Process input data

7	6	5	4	3	2	1	0
Output driver SPI error	Output driver channel error	Polyfuse tripped	Temperature warning	SPI error	AUX voltage error	AUX voltage warning	Acknowledge Required

Output Data

Three bytes of process data are received by P2M IO-Link from the IO-Link Master for control of solenoids.

Process output data (Byte 0)

7	6	5	4	3	2	1	0
EV8	EV7	EV6	EV5	EV4	EV3	EV2	EV1

Process output data (Byte 1)

7	6	5	4	3	2	1	0
EV16	EV15	EV14	EV13	EV12	EV11	EV10	EV9

Process output data (Byte 2)

7	6	5	4	3	2	1	0
EV24	EV23	EV22	EV21	EV20	EV19	EV18	EV17

Solenoid Pilots Addressing and Process Mapping

P2M IO-Link node addressing used with Moduflex Valve System

The P2M IO-Link node, when used with Moduflex Valve System can handle up to 19 pilot solenoid valves. Addressing will be done as shown below.

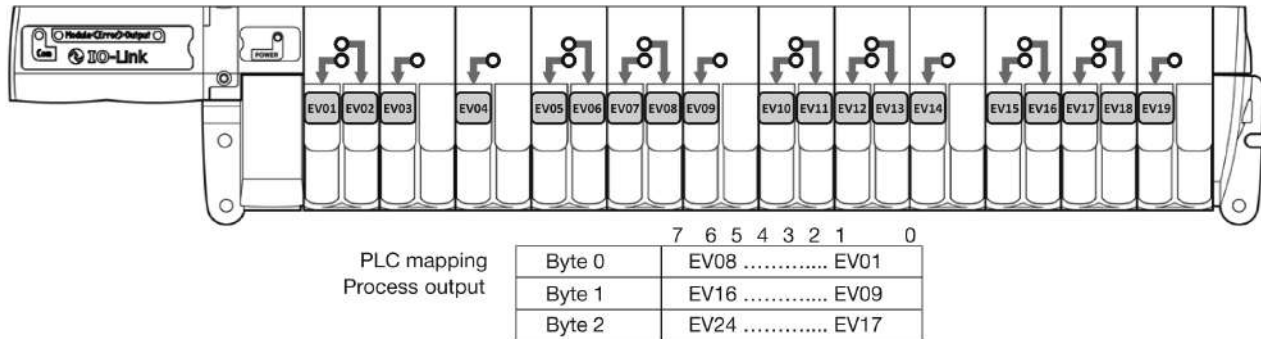

P2M IO-Link Module Electrical Specifications

IO-Link power supply	According to IO-Link standard V1.1.2
Speed communication	Com 2 - 38 kBd
Auxiliary power supply	20.4 VDC to 26.4 VDC
Current limit per channel	150 mA
Max current limit	4 A
Polarity inversion	YES
Short circuit protection	YES
Operating temperature	0°C to 55°C
Storage temperature	-25°C to 70°C
Shock according to IEC	60068-2-27:2008
Vibration according to IEC	60068-2-6:2007
EMC according to IEC	61000-4-2 up to -4-6

Network Diagnostic Through Process Mapping:

The P2M IO-Link module offers diagnostic data transmitted to the PLC through the master:

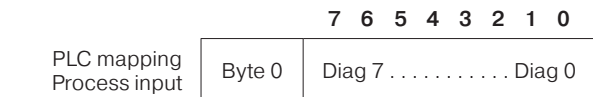

Diag bit	Error message	Detail
Diag 0	Fail-safe status	Acknowledgement required
Diag 1	Auxiliary voltage warning	Check auxiliary power
Diag 2	Auxiliary voltage failure	Check auxiliary power
Diag 3	Module failure	Module HS. must be replaced
Diag 4	Module over-temperature	
Diag 5	Module over-load	
Diag 6	Pilot solenoid(s) short circuit	Solenoid must be replaced
Diag 7	Outputs stage failure	

For further details, refer to the user manual: can be downloaded from www.parker.com/pdn/P2M_IOL



For inventory, lead times, and kit lookup, visit www.pdnplu.com

D53

Parker Hannifin Corporation
 Pneumatic Division
 Richland, Michigan
www.parker.com/pneumatics

D

Subbase & Manual Valves

H Series Micro

Moduflex Series







H Series ISO

Network Connectivity

DX ISOMAX Series

Valvair II Series

Peripheral Modules

Accessories	Description	Option	Part Number		
			Size 1	Size 2	
	Pressure regulator without gauge	0 to 30 PSI	P2M1PXST	P2M2PXST	
		0 to 60 PSI	P2M1PXSL	P2M2PXSL	
		0 to 120 PSI	P2M1PXSN	P2M2PXSN	
	Pressure regulator with gauge	0 to 30 PSI	P2M1PXSR	P2M2PXSR	
		0 to 60 PSI	P2M1PXSM	P2M2PXSM	
		0 to 120 PSI	P2M1PXSG	P2M2PXSG	
	Gauge	0 to 30 PSI	P2M1K0GT	P2M1K0GT	
		0 to 60 PSI	P2M1K0GL	P2M1K0GL	
		0 to 120 PSI	P2M1K0GN	P2M1K0GN	
	Push to connect fitting	5/32" or 4mm OD tube	Elbow	CMD04-1	
			Straight	FMD04-1	
		1/4" OD tube	Elbow	CMD07-1B	CMD07-2B
			Straight	FMD07-1B	FMD07-2B
		3/8" OD tube	Elbow		CMD09-2B
			Straight		FMD09-2B
		1/2" OD tube	Straight		FMD13-2B
		6mm OD tube	Elbow	CMD06-1	CMD06-2
			Straight	FMD06-1	FMD06-2
		8mm OD tube	Elbow		CMD08-2
			Straight		FMD08-2
		10mm OD tube	Elbow		CMD10-2
Straight			FMD10-2		
	Double male union	Connecting peripheral modules	HMDXX1	HMDXX2	
	Muffler for vacuum exhaust port		MMDVA1	MMDVA2	
	Plug		PMDYY1	PMDYY2	

Note: 85 Durometer minimum for pneumatic connectors.

D

Subbase & Manual Valves

H Series Micro

Moduflex Series

H Series ISO

Network Connectivity

DX ISOMAX Series

Valvair II Series



For inventory, lead times, and kit lookup, visit www.pdnplu.com

Dual P.O. Check Valve

Combined with a double 3/2 NC + NC valve, this module will block both flows and stop cylinder movement as soon as the valve's outputs are both exhausted. Better than a 3-Position valve, it provides more precise positioning when fitted close to the cylinder. Standard with manual release buttons.

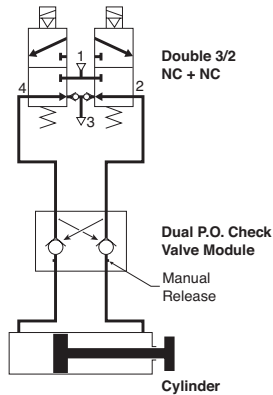

P2M1PXCA

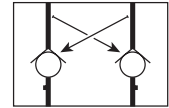

Application

At the outputs of a double 3/2 NC + NC valve, the dual P.O. check valve module achieves efficient and stable cylinder positioning. As soon as both lines are exhausted by the main control valve, the two internally piloted check valves close tight. The cylinder is then stabilized.

The manual pressure releases may then eventually be used for an adequate machine positioning.

Dual P.O. Check Valve

	Part Number
Size 1	P2M1PXCA
Size 2	P2M2PXCA

Dual Flow Control

By controlling the exhaust flows of a double-acting cylinder, this module can adjust both speeds — extend and retract. It may be plugged into the valve module output ports or mounted close to the cylinder in its in-line version.

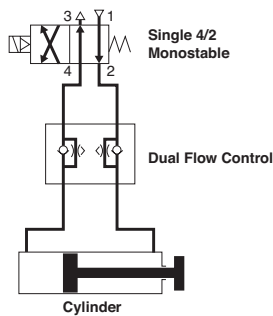

P2M1PXFA

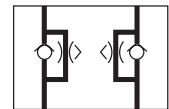

Application

On a double-acting cylinder, extend and retract speeds are adjusted separately by control of air flow exhaust. The control becomes more precise when the flow adjustment is close to the cylinder. The examples show different solutions which are dependent upon the valve-to-cylinder distance and accessibility to the cylinder.

Dual Flow Control Module

	Weight	Part Number
Size 1	1.06 oz	P2M1PXFA
Size 2	1.59 oz	P2M2PXFA

“P” Series Peripheral Modules Model Number Index
(Complete with Pneumatic Connectors)

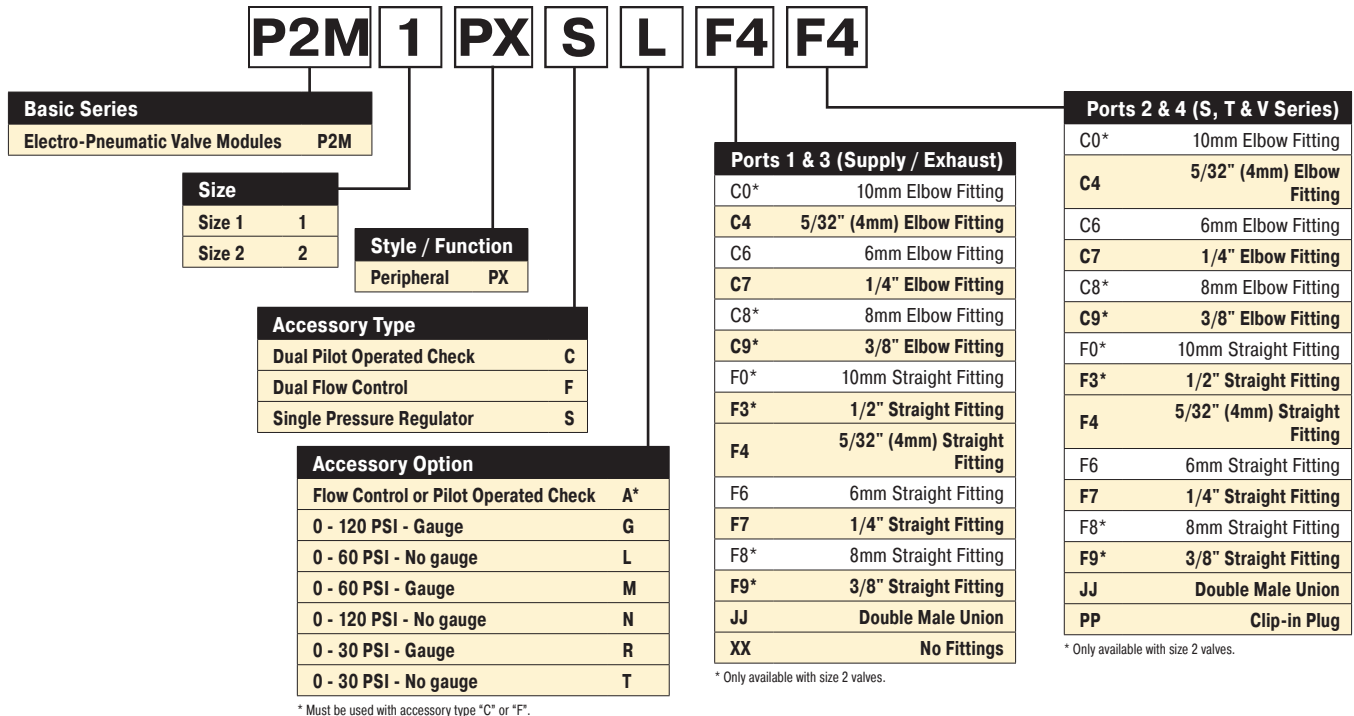

D
 Subbase & Manual Valves
 H Series Micro
 Moduflex Series
 H Series ISO
 Network Connectivity
 DX ISOMAX Series
 Valvair II Series

Regulator with Gauge



How to Order - Example: Size 1, Regulator with gauge, 1/4" OD straight fittings.

Line item	Quantity	Part Number	Description
Complete Peripheral Module			
1	1	P2M1PXSGF7F7	Size 1, Regulator with 0-160 PSI Gauge, 1/4" OD Straight Port Fittings in port 1, 2, 3, 4
Components			
1	1	P2M1PXSG	Size 1, Regulator with 0-160 PSI Gauge
2	4	FMD07-1B	Size 1-1/4" OD Tube Push-In Connector

Flow Control with Fittings



How to Order - Example: Size 1, Dual Flow Control, 1/4" OD straight fittings.

Line item	Quantity	Part Number	Description
Complete Peripheral Module			
1	1	P2M1PXFAF7F7	Size 1, Dual Flow Control, 1/4" OD Straight Port Fittings in Port 1, 2, 3, 4
Components			
1	1	P2M1PXFA	Size 1, Dual Flow Control
2	4	FMD07-1B	Size 1-1/4" OD Tube Push-In Connector



For inventory, lead times, and kit lookup, visit www.pdnplu.com

Vacuum Generator Applications

Depending on the application requirements, this vacuum generator may be controlled by single or by a dual 3/2 Moduflex valve. The Vacuum Generator has an integrated blow-off chamber that helps destroy the degree of vacuum. Blow-off can be increased with the addition of a control air input to the blow-off port on the vacuum module. A Ø6 mm port is available for an optional plug-in vacuum sensor for delivering a vacuum feedback signal.



Description	Weight	Size
Vacuum Generator	.88 oz	P2M1PXVA

Single 3/2 NC Air Control Valve

The 3/2 valve delivers the air supply to generate vacuum through the venturi. It also pressurizes the integrated blow-off chamber. When the 3/2 valve cuts-off the air supply, this chamber is automatically exhausted into the vacuum channel in order to speed-up the part release. In this type of application, it is preferred to have the vacuum generator mounted away from the control valve.

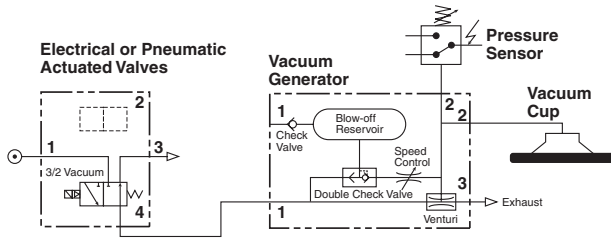

Dual 3/2 3/2 Valve Control

One 3/2 valve controls air supply for vacuum. The other 3/2 valve will generate an additional blow-off that may prove necessary to obtain quick part release from large vacuum pads. The effect of the blow-off can be controlled with an adjustable screw. In this type of circuit, the Vacuum Generator can be mounted directly to the valve by using Double Male Unions or as a stand alone item away from the control valve.

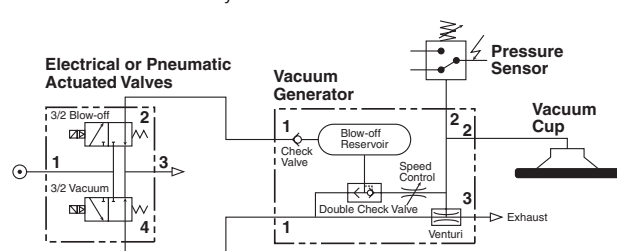

Vacuum Flow (SCFM)

Nozzle Diameter	inHg										
	0	3	6	9	12	15	18	21	24	27	30
P2M1PXVA	0.84	0.76	0.67	0.55	0.42	0.30	0.18	0.06	—	—	—

Evacuation Time

Series / Nozzle Diameter	Air Supply Pressure	Air Consumption	Evacuation Time in Sec / ft ³ to Reach Different Vacuum Levels (inHg)								
	PSI	SCFM	3	6	9	12	15	18	21	24	27
P2M1PXVA	70	1.60	5.6	14.2	22.0	42.4	62.3	85.0	116	198	—

* 1 ft³ = 28.31 liters

Vacuum Generator Model Number Index

P2M1PXVA F7 A F7 C MA

Basic Configuration	#1 Pressure Port	#2 Sensor Port	#2 Vacuum Port	#3 Exhaust Port
Basic Unit P2M1PXVA	5/32" (4mm) Elbow C4	A 6mm Plug	C4 5/32" (4mm) Elbow	C4 5/32" (4mm) Elbow
	6mm Elbow C6	B Plug	C6 6mm Elbow	C6 6mm Elbow
	1/4" Elbow C7	K 1/4" Straight	C7 1/4" Elbow	C7 1/4" Elbow
	Joint Fitting JJ	L 1/4" Elbow	F4 5/32" (4mm) Straight	F4 5/32" (4mm) Straight
	5/32" (4mm) Straight F4	M 6mm Elbow	F6 6mm Straight	F6 6mm Straight
	6mm Straight F6		F7 1/4" Straight	F7 1/4" Straight
	1/4" Straight F7		MA Muffler	
	No Fittings XX			

Port #1 Configuration	
Fitting in Pressure Port and Blow-Off Port	A
Fitting in Pressure Port and Blow-Off Port Plugged*	B

* Can not be directly mounting to valve.



For inventory, lead times, and kit lookup, visit www.pdnplu.com

D57

Parker Hannifin Corporation
 Pneumatic Division
 Richland, Michigan
www.parker.com/pneumatics

D

Subbase & Manual Valves

H Series Micro

Moduflex Series

H Series ISO

Network Connectivity

DX ISOMAX Series

Valvair II Series

Intermediate Supply Module Model Number Index

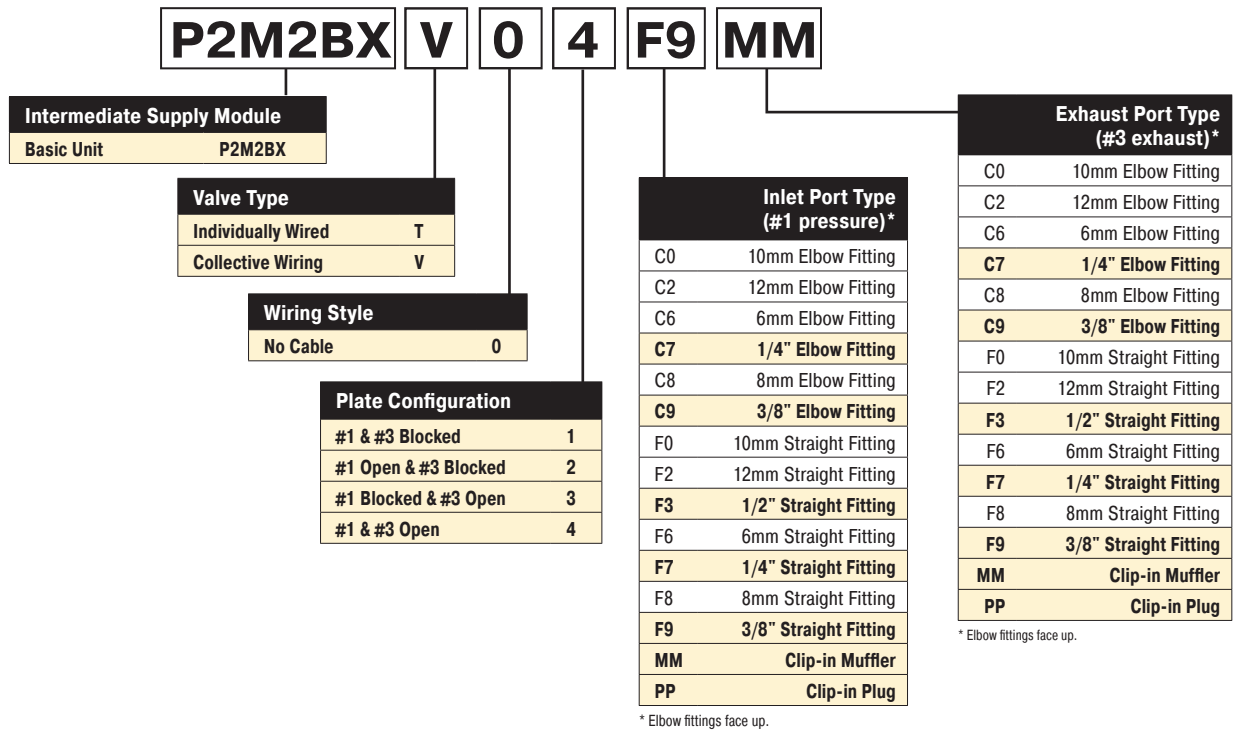

Plate Configuration



#1 & #3 Blocked

#1 Port connected to valves on the right only. Left is blocked.
 #3 Port connected to valves on the right only. Left is blocked.

#1 Open, #3 Blocked

#1 Port connected to valves on the right and the left.
 #3 Port connected to valves on the right only. Left is blocked.

#1 Blocked, #3 Open

#1 Port connected to valves on the right only. Left is blocked.
 #3 Port connected to valves on the right and the left.

#1 & #3 Open

#1 Port connected to valves on the right and the left.
 #3 Port connected to valves on the right and the left.



For inventory, lead times, and kit lookup, visit www.pdnplu.com

D

Subbase & Manual Valves

H Series Micro

Moduflex Series

H Series ISO

Network Connectivity

DX ISOMAX Series

Valvair II Series

Solenoid Pilot 24VDC

Description	Part Number
Solenoid pilot (without plug-in electrical connector)	P2D8V32C5
Air pilot with 5/32" (4mm) tube fitting	P2M2K0PA
Solenoid pilot (without clip connector)	P2D2W3226C5



Size 1 Valve Without Solenoid Pilot and Without Subbase

4-way / 2-position / Single Valve



P2M1X4EE

Solenoid	Part Number
Single solenoid (Monostable)	P2M1X4ES
Double solenoid (Bistable)	P2M1X4EE

4-way / 2-position / Dual Valve

Solenoid	Part Number
Solenoid spring with exhaust check	P2M1XJEE

3-way / 2-position / Dual Valve

Solenoid	Part Number
Double solenoid NC + NC with exhaust check	P2M1XDEE
Double solenoid NO + NO with exhaust check	P2M1XCEE
Double solenoid NC + NO with exhaust check	P2M1XEEE
Single solenoid NC with exhaust check	P2M1X3ES

Size 2 Valve Without Solenoid Pilot and Without Subbase

4-way / 2-position / Dual Valve



P2M2X4EE

Solenoid	Part Number
Single solenoid (Monostable)	P2M2X4ES
Double solenoid (Bistable)	P2M2X4EE

3-way / 2-position / Dual Valve

Solenoid	Part Number
Double solenoid NC + NC with exhaust check	P2M2XDEE
Double solenoid NO + NO with exhaust check	P2M2XCEE
Double solenoid NC + NO with exhaust check	P2M2XEEE
Single solenoid NC with exhaust check	P2M2X3ES

Set of Maintenance Parts

Description	Part Number
Clips Set of 14 clips: 6 for size 1 valves, 2 for size 2 valves, 4 for dual 4/2 valves, 2 for end plate and intermediate modules	P2M2K0CA
Seals Set of 10 seals: 3 for manifold to manifold seals, 3 under solenoid pilot seals, 4 under valve seals (two size 1 seals, two size 2 seals)	P2M2K0JA
Forks Set of 10 isolation forks for solenoid pilot manual override	P2M2K0FA

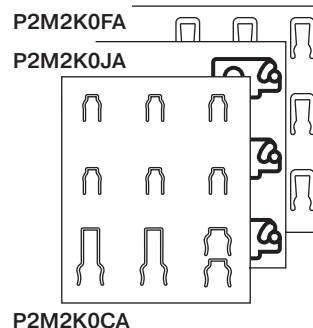

For inventory, lead times, and kit lookup, visit www.pdnplu.com

D59

Parker Hannifin Corporation
 Pneumatic Division
 Richland, Michigan
www.parker.com/pneumatics

D

Subbase & Manual Valves

H Series Micro

Moduflex Series

H Series ISO

Network Connectivity

DX ISOMAX Series

Valvair II Series

Moduflex Add-A-Fold Assembly Model Number Index
(Complete with Pneumatic and Electrical Connectors)

How To Order Plug-in Add-A-Fold Assemblies

1. List Add-A-Fold Assembly call out. This automatically includes the end plate kit assembly.
2. List valves and manifolds. List left to right, looking at the cylinder ports on the manifold.

P2MA V 0 1 C9 C9 ##

Moduflex Island Assembly	
Add-A-Fold	P2MA*

* Includes pneumatic H & T end plate kit.

Style	
Individually Wired	T
Collective Wiring	V*

* Includes 20-pin multi-connector or 25-pin, D-sub electrical head module.

Wiring / Bus Protocol	
No Cable (20-pin or multi-connector T series)	0 †
2 Meter Cable (20-pin)	2
5 Meter Cable (20-pin)	5
9 Meter Cable (20-pin)	9
Bus	
No Cable (25-pin, D-sub)	D
3 Meter Cable (25-pin, D-sub)	F

* Order bus module as a separate line item.
 † Default to option "0" for T series.

Pilot Source	
Internal Supply / Internal Exhaust	1
Internal Supply / External Exhaust	2
External Supply / Internal Exhaust	3
External Supply / External Exhaust	4

Number of Stations [†]	
01 - 19*	V-Type
01 - 30	T-Type

* Max. number of addresses for V type is 19. Single solenoid valves equal one address. Double solenoid valves equal two addresses. Maximum address may depend upon choice of bus protocol.
 † Intermediate modules are considered stations, but do not count against maximum number of addresses for manifold.

Exhaust Port Type (#3 Exhaust)*	
C0	10mm Elbow Fitting
C2	12mm Elbow Fitting
C6	6mm Elbow Fitting
C7	1/4" Elbow Fitting
C8	8mm Elbow Fitting
C9	3/8" Elbow Fitting
F0	10mm Straight Fitting
F2	12mm Straight Fitting
F3	1/2" Straight Fitting
F6	6mm Straight Fitting
F7	1/4" Straight Fitting
F8	8mm Straight Fitting
F9	3/8" Straight Fitting
MM	Clip-in Muffler
PP	Clip-in Plug

* Elbow fittings face up.

Inlet Port Type (#1 pressure)*	
C0	10mm Elbow Fitting
C2	12mm Elbow Fitting
C6	6mm Elbow Fitting
C7	1/4" Elbow Fitting
C8	8mm Elbow Fitting
C9	3/8" Elbow Fitting
F0	10mm Straight Fitting
F2	12mm Straight Fitting
F3	1/2" Straight Fitting
F6	6mm Straight Fitting
F7	1/4" Straight Fitting
F8	8mm Straight Fitting
F9	3/8" Straight Fitting
MM	Clip-in Muffler
PP	Clip-in Plug

* Elbow fittings face up.



"V" Series with 20-pin Connector



"V" Series with IO-Link

D

Subbase & Manual Valves

H Series Micro

Moduflex Series

H Series ISO

Network Connectivity

DX ISOMAX Series

Valvair II Series



For inventory, lead times, and kit lookup, visit www.pdnplu.com

How to Order -

Example: Application requires V Series valves with 20-Pin, D-Sub and 2 Meter cable. Manifold to include (1) Size 2, 4/2 Double Solenoid Valve - 3/8" OD fitting, (1) Size 1, 4/2 Single Solenoid Valve - 1/4" OD Elbow Fitting, Intermediate Module - 3/8" OD Fitting with Exhaust Muffler, Port 1 and 3 Blocked, (1) Size 1, Dual 3/2 NC Valve and (1) Size 1, 4-Way Double Solenoid Valve both with 1/4" OD Straight Fittings. Includes 3/8 OD Inlet Fitting and Exhaust Muffler.

Line Item	Quantity	Part Number	Description
Complete Manifold Assembly			
1	1	P2MAV21F9MM05	Moduflex Island Assembly, Pneumatic Head and Tail Module Set, Internal Pilot Supply, Internal Pilot Exhaust, 3/8" Straight Fitting Port 1, Port 3 Muffler.
2	1	P2M2V4EE2CV00F9	Size 2, Double Solenoid, 4/2, 3/8" Straight Pneumatic Connectors.
3	1	P2M1V4ES2CV00C7	Size 1, Single Solenoid, 1/4" Elbow Pneumatic Connectors.
4	1	P2M2BXV0A1F9MM	Intermediate Module 3/8" Straight Fitting with Exhaust Muffler
5	1	P2M1VDEE2CV00C7	Size 1, Dual 3/2 NC + NC, 1/4" Elbow Pneumatic Connectors.
6	2	P2M1VJEE2CV00F7	Size 1, Dual 4/2, 1/4" Straight Pneumatic Connectors.

Components

1	1	P2M2HXT01	Pneumatic Head and Tail Module Set
2	1	P2M2HEV0A	20-Pin, Multi-Connector Electrical Head Module
3	1	P8LMH20M2A	2 Meter, 20-Pin Cable
4	1	P2M2V4EE2CV	Size 2, V Series Island Valve Module, Double Solenoid, 4-Way
5	1	P2M1V4ES2CV	Size 1, V Series Island Valve Module, Single Solenoid, 4-Way
6	1	P2M2BXV0A	Intermediate Module
7	1	P2M1VGEE2CV	Size 1, V Series Island Valve Module, Dual 3/2 NC + NC
8	2	P2M1VJEE2CV	Size 1, V Series Island Valve Module, Dual 4/2
9	2	CMD07-1B	Size 1, 1/4" OD Tube Elbow Push-in Connector
10	6	FMD07-1B	Size 1, 1/4" OD Tube Straight Push-in Connector
11	4	FMD09-2B	Size 2, 3/8" OD Tube Straight Push-in Connector
12	2	MMDVA2	Clip-on Muffler

How to Order -

Example: Application requires V Series valves with IO-Link Class A Module. Manifold to include (1) Size 2, 4/2 Double Solenoid Valve - 3/8" OD fitting, (1) Size 1, 4/2 Single Solenoid Valve - 1/4" OD Elbow Fitting, Intermediate Module - 3/8" OD fitting with Exhaust Muffler, Port 1 and 3 Blocked, (1) Size 1, Dual 3/2 NC Valve and (1) Size 1, 4-Way Double Solenoid Valve both with 1/4" OD Straight Fittings. Include 3/8 OD Inlet Fitting and Exhaust Muffler.

Line Item	Quantity	Part Number	Description
Complete Manifold Assembly			
1	1	P2MAVB1F9MM05	Moduflex Island Assembly, Pneumatic Head and Tail Module Set, Internal Pilot Supply, Internal Pilot Exhaust, 3/8" Straight Fitting Port 1, Port 3 Muffler.
2	1	P2M2HBVL12400AB	IO-Link Class A Module
3	1	P2M2V4EE2CV00F9	Size 2, Double Solenoid, 4/2, 3/8" Straight Pneumatic Connectors.
4	1	P2M1V4ES2CV00C7	Size 1, Single Solenoid, 1/4" Elbow Pneumatic Connectors.
5	1	P2M2BXV0A1F9MM	Intermediate Module 3/8" Straight Fitting with Exhaust Muffler
6	2	P2M1VDEE2CV00C7	Size 1, Dual 3/2 NC + NC, 1/4" Elbow Pneumatic Connectors.
7	1	P2M1VJEE2CV00F7	Size 1, Dual 4/2, 1/4" Straight Pneumatic Connectors.

Components

1	1	P2M2HXT01	Pneumatic Head and Tail Module Set
2	1	P2M2HBVL12400AB	IO-Link Class A Module
3	1	P2M2V4EE2CV	Size 2, V Series Island Valve Module, Double Solenoid, 4-Way
4	1	P2M1V4ES2CV	Size 1, V Series Island Valve Module, Single Solenoid, 4-Way
5	1	P2M2BXV0A	Intermediate Module
6	1	P2M1VGEE2CV	Size 1, V Series Island Valve Module, Dual 3/2 NC + NC
7	2	P2M1VJEE2CV	Size 1, V Series Island Valve Module, Dual 4/2
8	2	CMD07-1B	Size 1, 1/4" OD Tube Elbow Push-in Connector
9	6	FMD07-1B	Size 1, 1/4" OD Tube Straight Push-in Connector
10	4	FMD09-2B	Size 2, 3/8" OD Tube Straight Push-in Connector
11	2	MMDVA2	Clip-on Muffler



For inventory, lead times, and kit lookup, visit www.pdnplu.com

D61

Parker Hannifin Corporation
 Pneumatic Division
 Richland, Michigan
www.parker.com/pneumatics

D

Subbase & Manual Valves

H Series Micro

Moduflex Series

H Series ISO

Network Connectivity

DX ISOMAX Series

Valvair II Series

Internal and external pilot supply options

All T and V Series Valve bases incorporate an auxiliary channel “X” to supply pressure to the solenoid pilots. The “X” galley is pressurized from the left hand end plate. Depending on the configuration of the left hand end plate, this pressure is either supplied from the #1 port in the left hand end plate or supplied externally through a 4mm OD tube fitting in the left hand end plate. This fitting is supplied in all left hand end plates and can be converted in the field.

Internal and external solenoid pilot exhaust options

All T and V Series Valve bases incorporate an auxiliary channel “E” which is used to exhaust the solenoid pilot pressure from each solenoid valve. The “E” galley is connected to the left hand end plate. Depending on the configuration of the left hand end plate, this exhaust is either connected to the #3 exhaust port or is connected to a 4mm OD Tube fitting in the left hand end plate. This fitting is supplied in all left hand end plates and can be converted in the field.

To configure the left hand end plate, with pressure off, remove head cover to expose the selector section. Loosen selector section and rotate “X” or “E” channel selector to desired position. Tighten selector section and assemble cover.

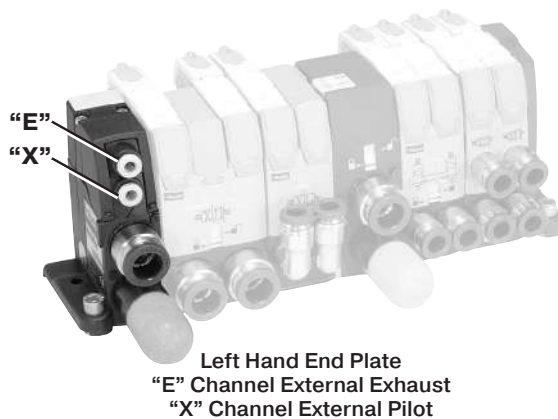
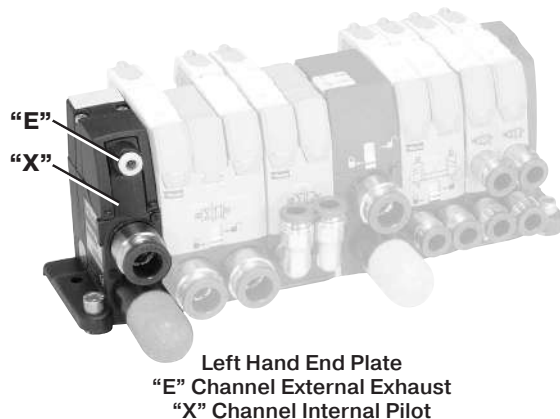
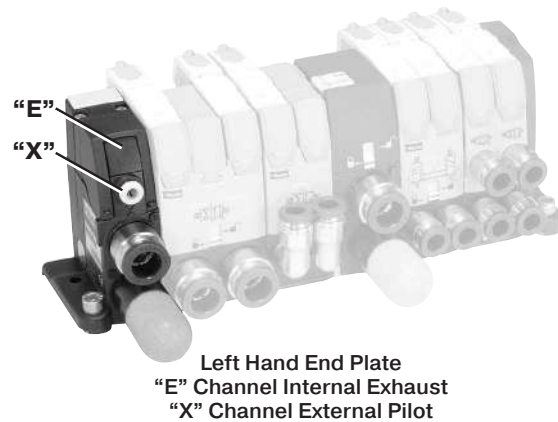
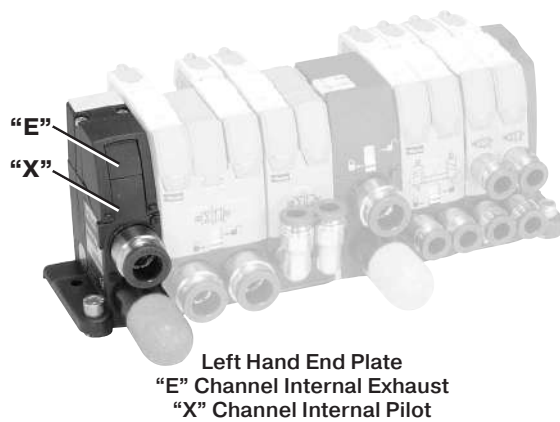
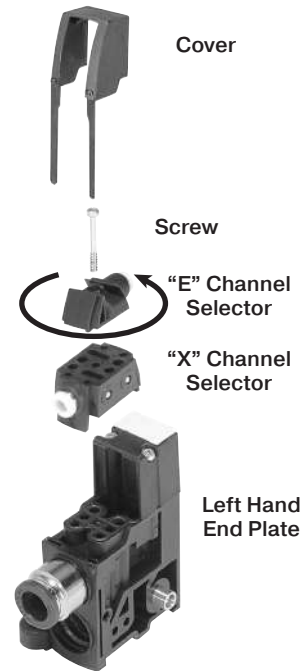

D	Subbase & Manual Valves
	H Series Micro
Moduflex Series	H Series ISO
Network Connectivity	DX ISOMAX Series
Valvair II Series	



For inventory, lead times, and kit lookup, visit www.pdnplu.com

“V”, “T” and “S” Series Maintenance

The latest generations of compact pneumatic valves have a life expectancy which generally exceeds the equipment they control. Therefore, maintenance is seldom required. When it is

necessary to change the solenoid pilot, valve or connector, they can be easily replaced without removing the island base, as shown below.

“S” Series

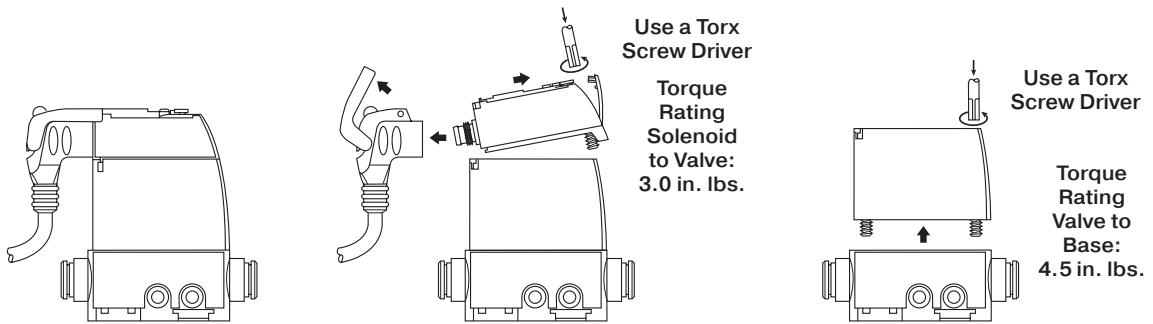

“T” Series

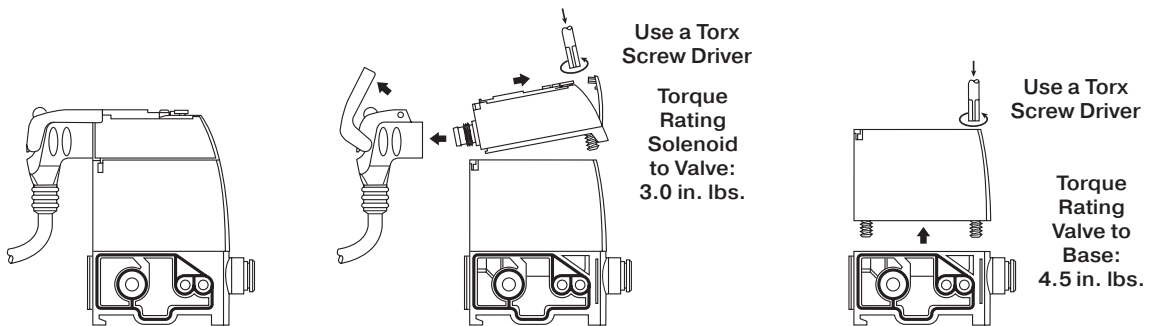

“V” Series

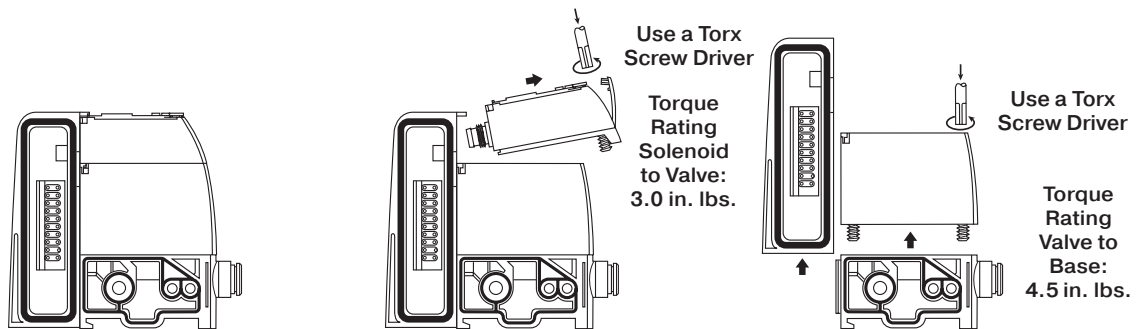

Fitting and Tubing Installation

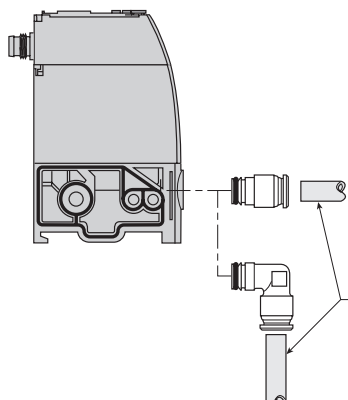

Fitting Assembly: Pneumatic Connectors are retained by a clip in each module. Assembly is achieved by pushing the fitting into the module and sliding the clip down over the groove in the fitting. Pull fitting to check that it is secure.

Tubing Assembly: Cut tubing squarely & cleanly. Inspect the tubing to insure there are no sharp edges that may nick or cut the o-ring seal. Insert tubing into fitting until it bottoms out. A slight pull on the tube afterwards can help verify it is properly retained / inserted.

Tubing Disassembly: When it is required to remove the tubing from the fitting push the release button in towards the fitting & remove the tubing.

Tubing Reassembly: Inspect the tubing before re-inserting it for any scoring or other damage that would affect the o-ring sealing. It is recommended that for every insertion, the tubing end be trimmed, especially if it has any scoring or damage.

Pneumatic Valve Specifications

Fluid	Air, inert gas, filtered 40µ ¹ , dry ² or lubricated ³		
Operating Pressures	Vacuum to 120 PSI		
Piloting Pressure	43 to 120 PSI for operating pressures below, use external pilot supply available on all head modules ⁵		
Pilot Supply	Internal with "S" Series, mixed internal / external with "T" and "V" Series		
Exhaust Collection	All exhausts are collectable, including solenoid pilot exhaust		
Life Cycle	100 million operations ⁴ (with dry air, 3 Hz, 20°C, 6 bar)		
Operating Temperatures	5°F to 140°F (32°F to 130°F for field bus systems)		
Stocking Temperatures	-40°F to 155°F		
Vibration Resistance	According to IEC 68 - 2 - 6	2G	2 to 150 Hz
Impact Resistance	According to IEC 68 - 2 - 27	15G	11 ms

1. Class 5 according to ISO 8573-1
 2. Class 4 according to ISO 8573-1
 3. With main air supply lubricated, monitor lubrication rate so that valve bank is not flooded with lubricant.
 4. 4/2 valve
 5. Double 3/2 minimum 50 PSI

Electrical Specifications

Rated Coil Voltage	24VDC		
Allowable Voltage Fluctuation	-15% to +10 % of nominal voltage		
Electrical Connection	Polarity insensitive: PNP and NPN compatible		
Coil insulation Type	Class B		
Power Consumption	1W (42 mA)		
Manual Override	Locking or non-locking, isolated if required		
Response Time of the Complete Valve	9.6 ms ± 1.2 on 4/2 Double Solenoid Valve Size 1	According to ISO 12238	
	12.0 ms ± 1.2 on 4/2 Single Solenoid Valve Size 1		
	14.8 ms ± 2 on 4/2 Double Solenoid Valve Size 2 17.0 ms ± 2 on 4/2 Single Solenoid Valve Size 2		
Type of Use	Continuous-duty Solenoid		
Dust and Water Protection	According to EN 60 529	"S" and "T" Series:	M8 IP67
			Clip IP40
		"V" Series:	IP65

Specifications

1/4", 3/8" and 1/2" Fittings

Construction

Nickel Plated Brass Body; O-ring: Nitrile (Buna N) lubricated with Silicone lubricant; Grab Ring: 301 Stainless Steel; One Piece Button Collet: PVDF – black

Recommended Parker Tubing Series:

E (Linear Low Density Polyethylene), PP (Polypropylene), N (Plasticized Polyamide, Nylon), NR (Unplasticized Polyamide, Rigid Nylon), U (Polyurethane 90 Durometer Shore A), HU (Polyurethane 95 Durometer Shore A)

Other materials: Polyurethane 85 Durometer Shore A – Applications and service conditions vary and therefore the use of a tube support may be required for any 85A PU tubing. The following commercially available O.D. – I.D. 85A tubing sizes require the use of a tube support regardless of application. (5/32" – 3/32", 3/16" – 1/8", 1/4" - .170", 1/4" – 3/16", 5/16" – 1/4", 3/8" – 5/16", 1/2" – 3/8") Prestolok fittings should not be used for live swivel applications. Vacuum applications dependent upon temperature and type of tubing used.

6mm, 8mm, 10mm, 12mm Fittings

Construction

Polyamid HR Body (Right Angle), Nickel Plate Brass Body (Straight); O-ring: Nitrile (Buna N) lubricated with Silicone lubricant; Sleeve: Polyamide HR Body; Grab Ring: 301 Stainless Steel; One Piece Button Collet: Polyacetal - black

Recommended Parker Tubing Series for 6mm, 8mm, 10mm, 12mm Fittings:

E (Linear Low Density Polyethylene), N (Plasticized Polyamide, Nylon), U (Polyurethane 90 Durometer Shore A), HU (Polyurethane 95 Durometer Shore A) Prestolok fittings should not be used for live swivel applications. Vacuum applications dependent upon temperature and type of tubing used.

D
 Subbase & Manual Valves
 H Series Micro
 Moduflex Series
 H Series ISO
 Network Connectivity
 DX ISOMAX Series
 Valvair II Series



For inventory, lead times, and kit lookup, visit www.pdnplu.com

D64

Parker Hannifin Corporation
 Pneumatic Division
 Richland, Michigan
www.parker.com/pneumatics

"S" Series Individual Subbase Valve Dimensions and Mounting

Subbase Valve Size 1



Subbase Valve Size 2



Surface Mounting with Screws 4 mm Dia. into Retractable Brackets 3mm Thick

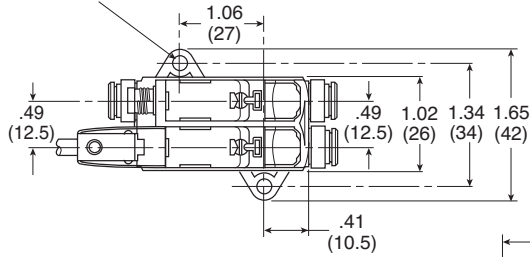

Surface Mounting with Screws 4 mm Dia. into Retractable Brackets 3mm Thick

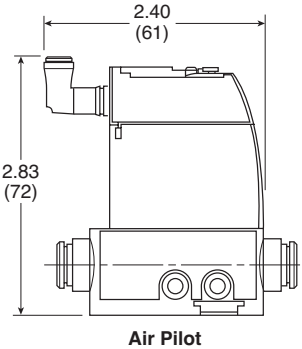
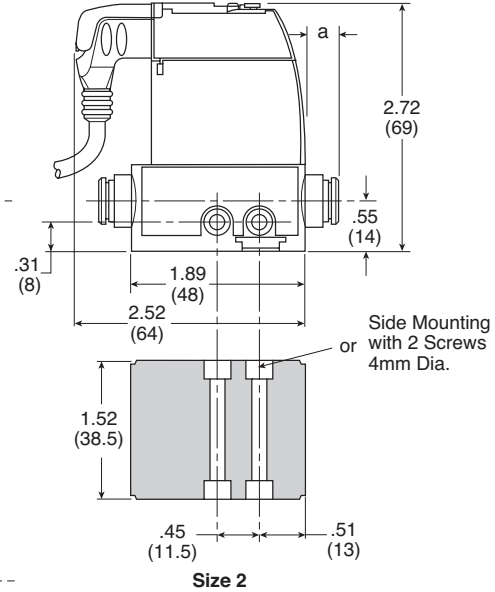
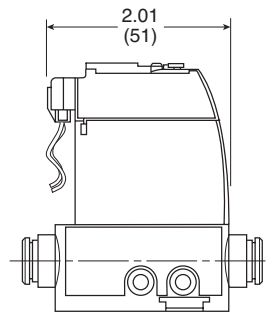
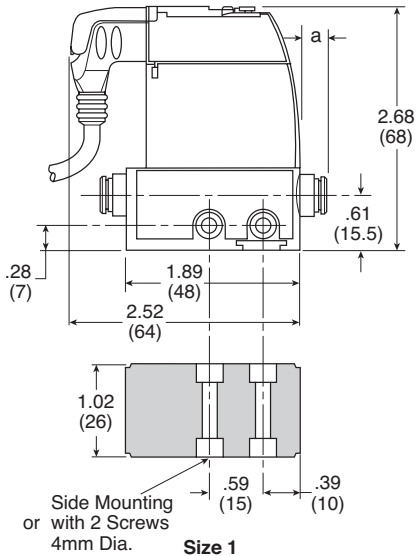
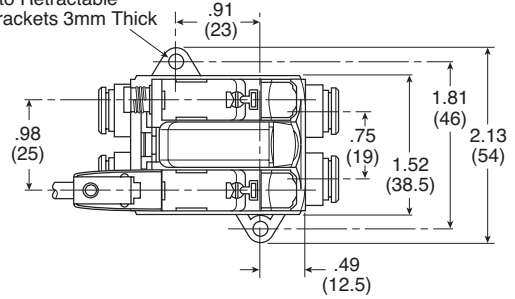

Air Pilot

OD Tube Ext.	a	b	c
5/32" (4 mm)	8	10	12
Size 1 Valves			
6 mm	8	13	16
1/4"	15	18	22
Muffler		31	
Size 2 Valves			
1/4"	12	18	22
8 mm	9	16	19
3/8"	16	23	26
10 mm	13	18	22
Muffler		40	

Special Case: 4/3 all ports blocked. Add the dual P.O. check valve that has been plugged in the basic valve.

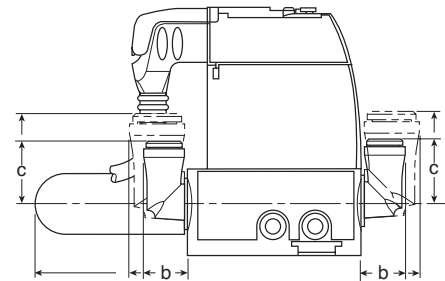

For inventory, lead times, and kit lookup, visit www.pdnplu.com

D65

Parker Hannifin Corporation
 Pneumatic Division
 Richland, Michigan
www.parker.com/pneumatics

D

Subbase & Manual Valves

H Series Micro

Moduflex Series

H Series ISO

Network Connectivity

DX ISOMAX Series

Valvair II Series

"T" Series Manifold Dimensions and Mounting



Total Width Depends on Valve Composition

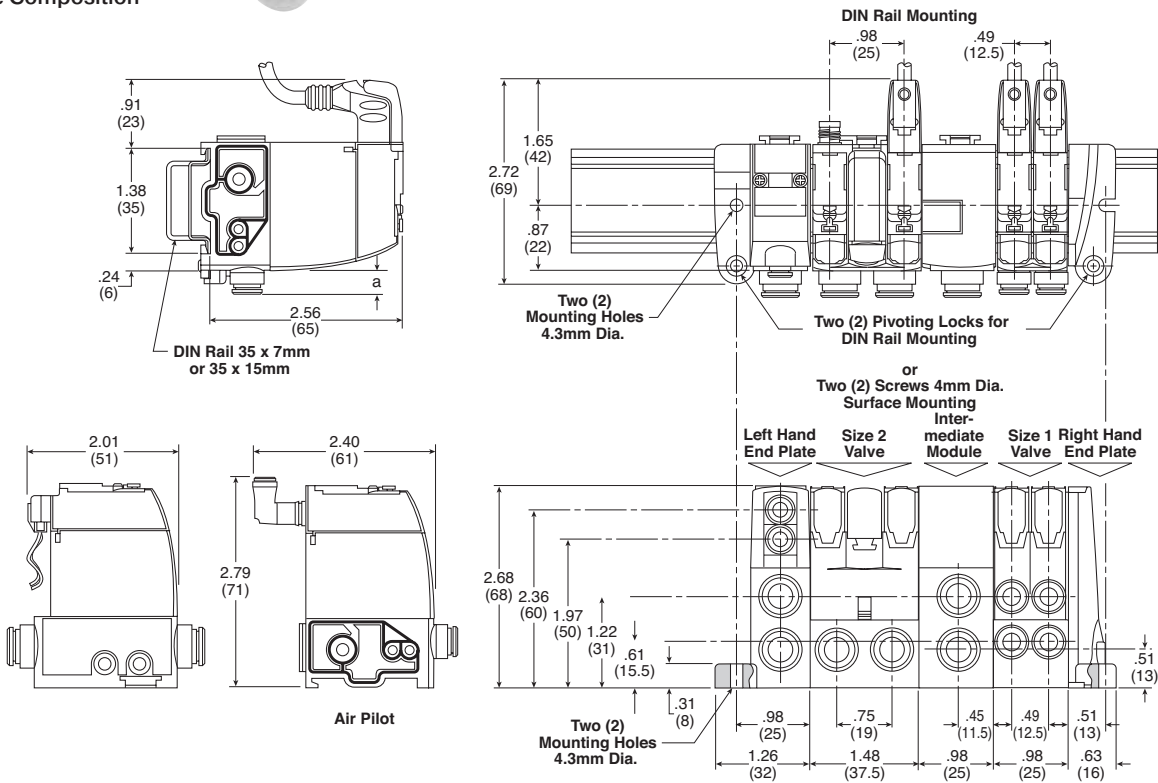

Special Case: 4/3 all ports blocked function within island version, add the dimensions of the dual P.O. check valve plugged into the island.

End Plate and Intermediate Modules

	a	b	c
6 mm Tube OD	8	13	16
1/4" Tube OD	12	18	22
8 mm Tube OD	9	16	19
3/8" Tube OD	16	23	26
10 mm Tube OD	13	18	25
12 mm Tube OD	13	19	25
1/2" Tube OD	13		
Muffler	40		

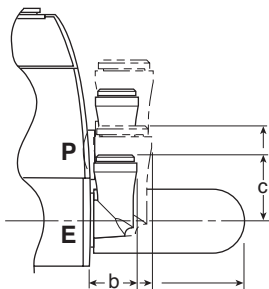

OD Tube	Ext.	a	b	c
	5/32" (4 mm)	8	10	12
Size 1 Valves	6 mm	8	13	16
	1/4"	15	18	22
Size 2 Valves	1/4"	12	18	22
	8 mm	9	16	19
	3/8"	16	23	26
	10 mm	13	18	22

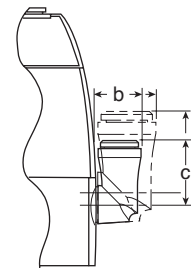

D
 Subbase & Manual Valves
 H Series Micro
 Moduflex Series
 H Series ISO
 Network Connectivity
 DX ISOMAX Series
 Valvair II Series



For inventory, lead times, and kit lookup, visit www.pdnplu.com

"V" Series Manifold Dimensions and Mounting
 20-pin, Multi-Connector Valve Manifold



Total Width Depends on Valve Composition

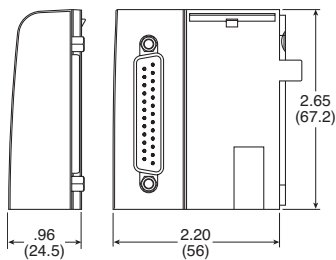
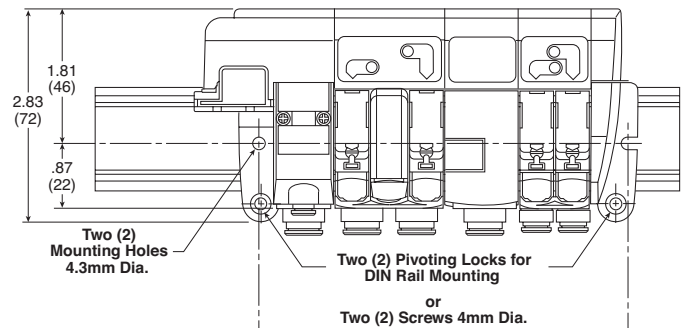
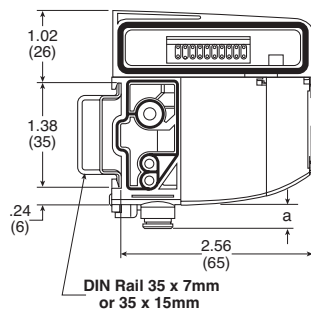

25-pin, D-Sub

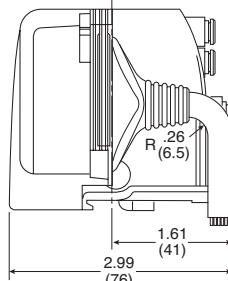

20-pin, Multi-Connector

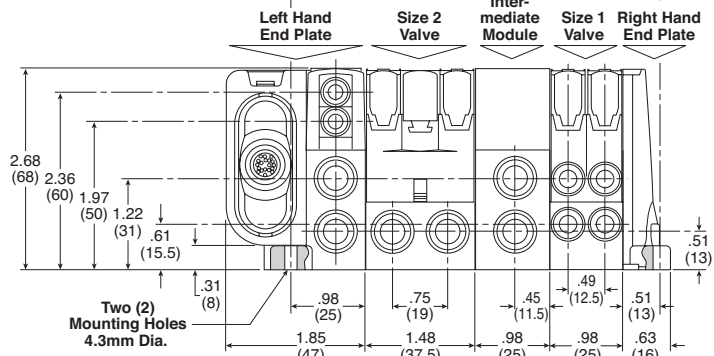

End Plate and Intermediate Modules

	a	b	c
6 mm Tube OD	8	13	16
1/4" Tube OD	12	18	22
8 mm Tube OD	9	16	19
3/8" Tube OD	16	23	26
10 mm Tube OD	13	18	25
12 mm Tube OD	13	19	25
1/2" Tube OD	13		
Muffler	40		

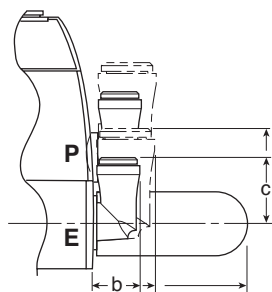

OD Tube	Ext.	a	b	c
Size 1 Modules	5/32" (4 mm)	8	10	12
	6 mm	8	13	16
	1/4"	15	18	22
Size 2 Modules	1/4"	12	18	22
	8 mm	9	16	19
	3/8"	16	23	26
	10 mm	13	18	22

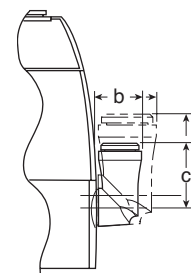

For inventory, lead times, and kit lookup, visit www.pdnplu.com

D67

Parker Hannifin Corporation
 Pneumatic Division
 Richland, Michigan
www.parker.com/pneumatics

D	Subbase & Manual Valves
Moduflex Series	H Series Micro
Moduflex Series	H Series ISO
Moduflex Series	Network Connectivity
Moduflex Series	DX ISOMAX Series
Moduflex Series	Valvair II Series

“V” Series Manifold Dimensions and Mounting
P2M Connected Valve Manifolds

Total Width Depends
 on Valve Composition



Industrial Ethernet and IO-Link P2M Network Nodes with Valve Manifold

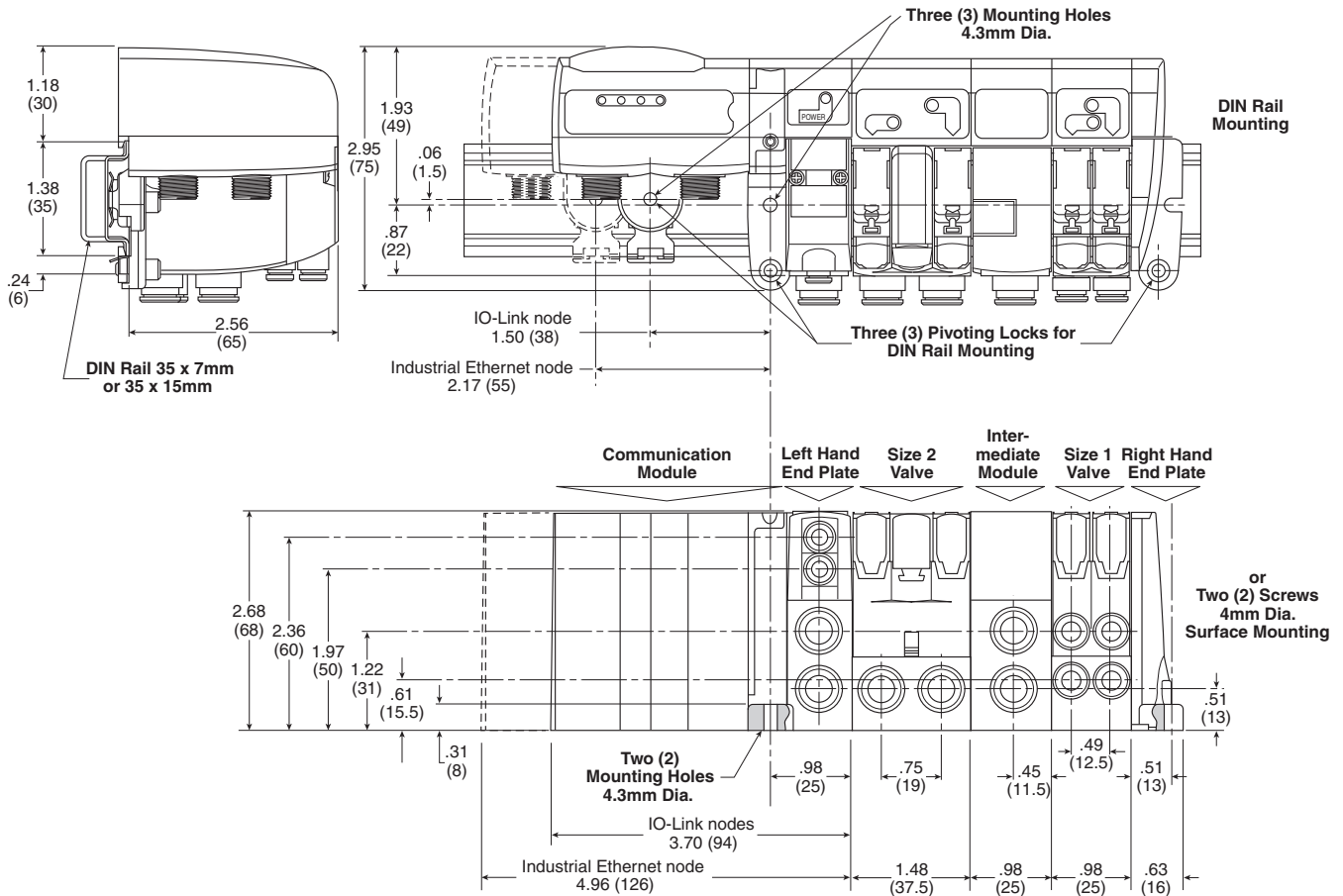

D	Subbase & Manual Valves
	H Series Micro
Modulflex Series	
H Series ISO	
Network Connectivity	
DX ISOMAX Series	
Valvair II Series	



For inventory, lead times, and kit lookup, visit www.pdnplu.com

D68

Parker Hannifin Corporation
 Pneumatic Division
 Richland, Michigan
www.parker.com/pneumatics

"P" Series Peripheral Modules Dimensions and Mounting

Reminder: Peripheral modules may either be plugged in the valve output ports or mounted in-line separate from the valve.

Peripheral Module Plugged in a Valve

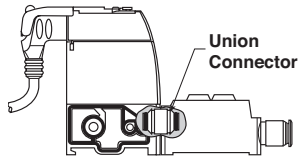

In-Line Peripheral Modules: Mounting is Required

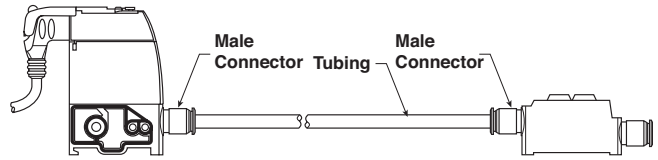

Dual Flow Control Size 1

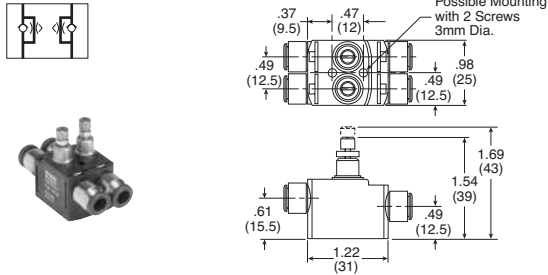

Dual Flow Control Size 2

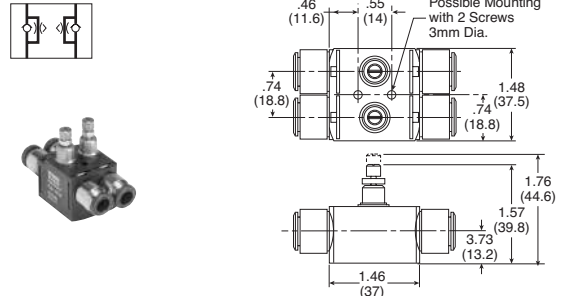

Pressure Regulator Size 1

With Gauge

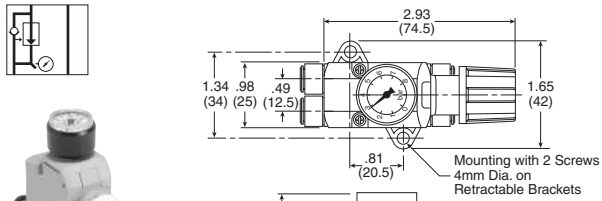

Pressure Regulator Size 2

With Gauge

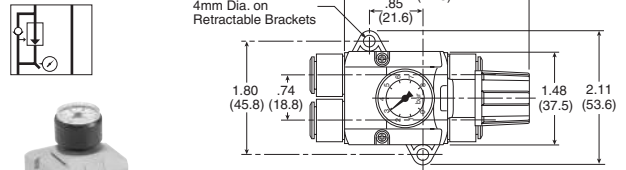

Without Gauge

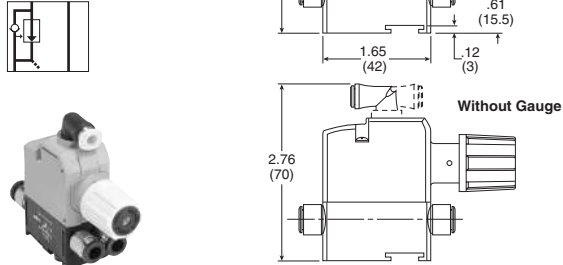

Without Gauge

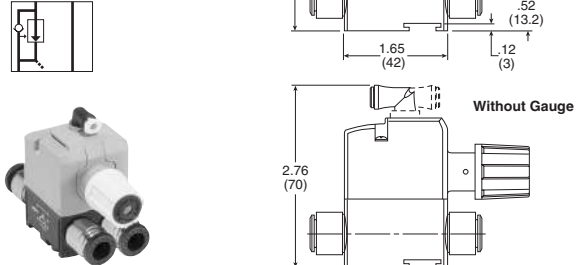

Dual P.O. Check Valve Size 1

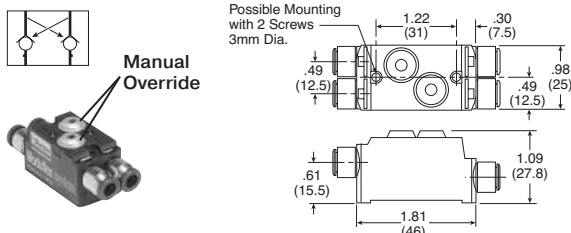

Dual P.O. Check Valve Size 2

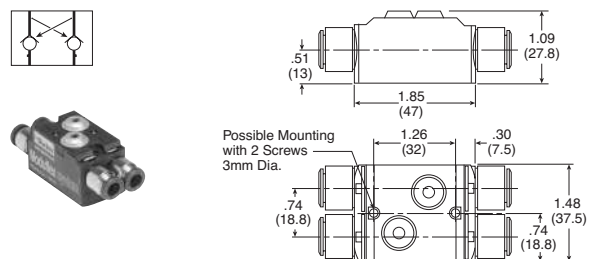

For inventory, lead times, and kit lookup, visit www.pdnplu.com

D

Subbase & Manual
Valves

H Series
Micro

Modurflex
Series

H Series
ISO

Network
Connectivity

DX ISOMAX
Series

Valvaire II
Series



For inventory, lead times, and kit lookup, visit www.pdnplu.com

D70

Parker Hannifin Corporation
Pneumatic Division
Richland, Michigan
www.parker.com/pneumatics

H Series ISO

The H Series ISO valve conforms to international standards 15407 and 5599, providing maximum flexibility for end users. As Parker's premier manifold mount product offering, H Series ISO offers machine builders a complete offering with a wide variety of accessories and options in a valve family with flow ranges from 0.55 Cv up to 6.0 Cv. HB/HA/H1/H2/H3 can be mounted on the same manifold. Individual wiring is available with DIN or central connectors, and collective solutions offer installation time savings with either multi-pin connectors or network solutions.

Ports, Flow

- H Universal Manifold
 - HB: 1/8 inch, 0.55 Cv
 - HA: 1/4 inch, 1.1 Cv
 - H1: 3/8 inch, 1.5 Cv
 - H2: 1/2 inch, 3.0 Cv
- H Classic Manifold (not compatible with H Universal without H3 Transition Kit)
 - H3: 3/4 inch, 6.0 Cv
- NPT and BSPP "G" standard

Solenoids

- HB & HA: 24 VDC, 1.0 Watt, and 120 VAC, 1.0 VA
- H1, H2, & H3: 24 VDC, 3.2 Watt, 120 VAC, 4.5 VA, 24 VDC, 1.3 Watt

Certification / approval

- IP65 rated
- cCSAus approved voltages:
 - 15407-2 & 5599-2 24VDC manifolds only
 - 15407-2 & 5599-2 single subbase, all voltages
 - 15407-1 & 5599-1 manifold and single subbase, all voltages
- BSPP manifold and subbase ports meet ISO 1179 specifications

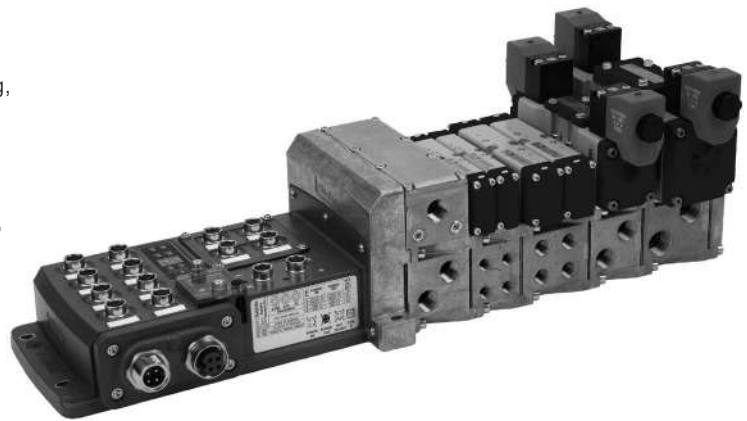

Operating Information

Operating pressure:	Vacuum to 145 PSIG (Vacuum to 10 bar)
Pilot pressure:	See chart
Temperature range:	5°F to 120°F (-15°C to 49°C)

Material Specifications

Body	Aluminum
End caps	PBT
End plates	Aluminum
Fasteners	Zinc plated steel
Manifolds	Aluminum
Seals	Nitrile
Spool	Aluminum

Operating Pressure

Maximum: 145 PSIG (1000 kPa)

Minimum: see below chart

Operator / Function	Internal Pilot	PSIG (Min. kPa) HB	PSIG (Min. kPa) HA	PSIG (Min. kPa) H1	PSIG (Min. kPa) H2	PSIG (Min. kPa) H3
1	Single solenoid - 2-position	30	25	25	25	35
2	Double solenoid - 2-position	(207)	(173)	(173)	(173)	(241)
3	Single remote pilot - 2-position**	Vacuum	Vacuum	Vacuum	Vacuum	Vacuum
4	Double remote pilot - 2-position**	Vacuum	Vacuum	Vacuum	Vacuum	Vacuum
5, 6, 7	Double solenoid - 3-position APB, CE, PC	35 (241)	35 (241)	35 (241)	50 (345)	50 (345)
8, 9, 0	Double remote pilot - 3-position** APB, CE, PC	Vacuum	Vacuum	Vacuum	Vacuum	Vacuum
E	Single solenoid pilot - 2-position					
	Air return / spring assist	30 (207)	30 (207)	35 (241)	45 (310)	45 (310)
F	Single remote pilot - 2-position**					
	Air return / spring assist					
N, P, Q	Double solenoid - dual 3/2	30 (207)	N/A	N/A	N/A	N/A
	External pilot*	*	*	*	*	*
All	H Series	Vacuum	Vacuum	Vacuum	Vacuum	Vacuum

* External Pilot Pressure / Remote Pilot Supply - Must meet or exceed minimum pilot pressure for internal pilot option. Not available on Operator / Function N, P, or Q.

** Must be equal to or greater than operating pressure.



For inventory, lead times, and kit lookup, visit www.pdnplu.com

D71

Parker Hannifin Corporation
Pneumatic Division
Richland, Michigan
www.parker.com/pneumatics

D

Subbase & Manual Valves

H Series Micro

Moduflex Series

H Series ISO

Network Connectivity





DX ISOMAX Series

Valvair II Series

Features

H Series ISO

Right Sizing

-  ISO 15407-1 (Non Plug-in)
-  ISO 15407-2 (Plug-in)
-  ISO 5599-1 (Non Plug-in)
-  ISO 5599-2 (Plug-in)

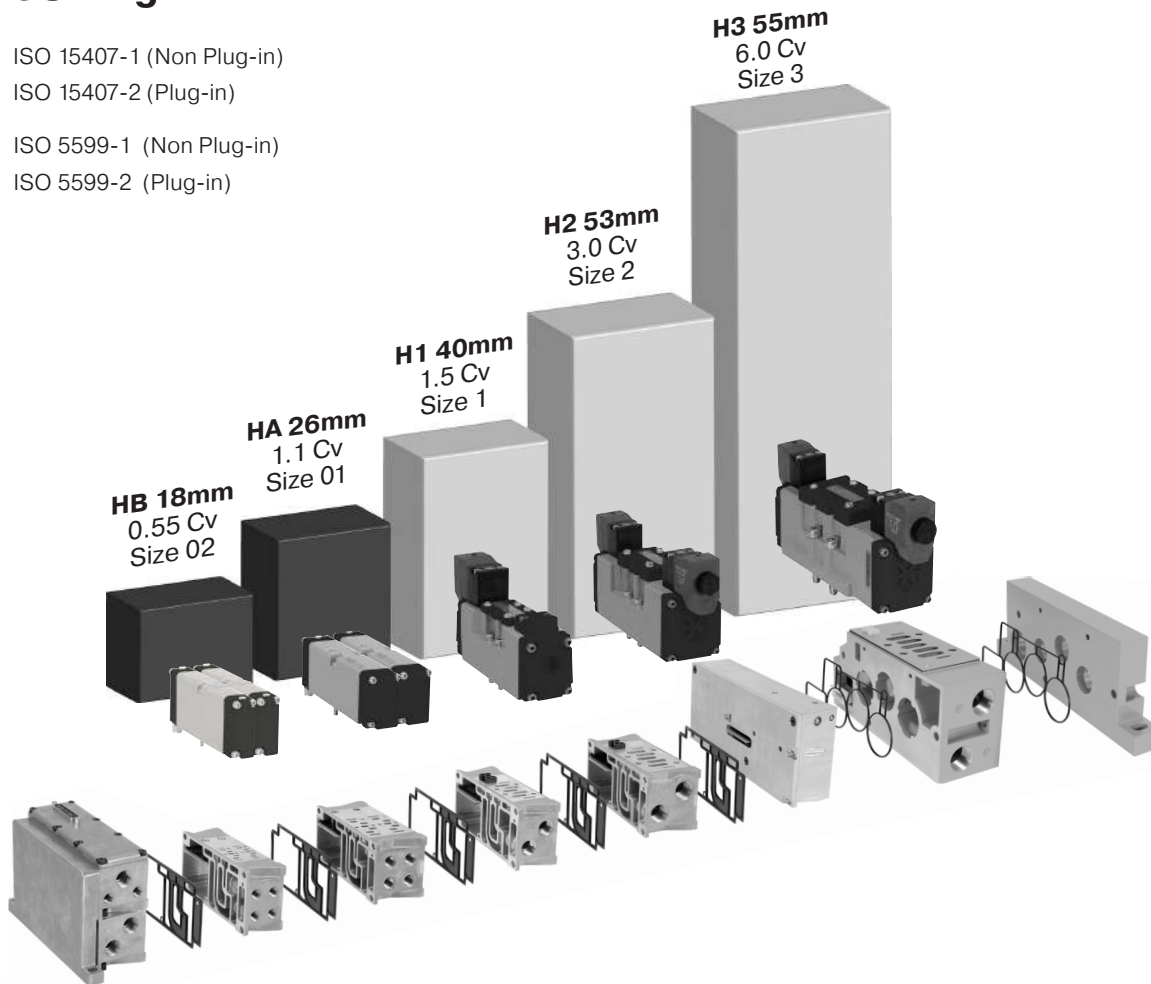

Cylinder Bore Size - inches (mm)

Cylinder Speed - in/s (mm/s)	Cylinder Bore Size - inches (mm)							
	1-1/4" (32 mm)	1-1/2" (40 mm)	2.00" (50 mm)	2-1/2" (63 mm)	3-1/4" (80 mm)	4.00" (100 mm)	5.00" (125 mm)	6.00" (150 mm)
1.96 (50)	0.03	0.04	0.06	0.10	0.17	0.26	0.41	0.59
3.93 (100)	0.05	0.08	0.13	0.21	0.35	0.53	0.82	1.19
5.90 (150)	0.08	0.12	0.20	0.31	0.52	0.79	1.24	1.78
7.87 (200)	0.10	0.16	0.26	0.41	0.69	1.05	1.64	2.37
9.84 (250)	0.13	0.20	0.33	0.52	0.87	1.32	2.06	2.97
11.81 (300)	0.16	0.25	0.40	0.62	1.05	1.58	2.47	3.56
13.77 (350)	0.18	0.29	0.46	0.72	1.22	1.85	2.88	4.15
15.74 (400)	0.21	0.33	0.53	0.82	1.39	2.11	3.30	4.75
17.71 (450)	0.24	0.37	0.59	0.93	1.57	2.37	3.71	5.34
19.68 (500)	0.26	0.41	0.66	1.03	1.74	2.64	4.12	5.94
	HB		HA		H1	H2	H3	



D72



For inventory, lead times, and kit lookup, visit www.pdnplu.com

Parker Hannifin Corporation
 Pneumatic Division
 Richland, Michigan
www.parker.com/pneumatics

D
 Subbase & Manual Valves
 H Series Micro
 Modulflex Series
 H Series ISO
 Network Connectivity
 DX ISOMAX Series
 Valvair II Series

Connectivity

EtherNet/IP DeviceNet

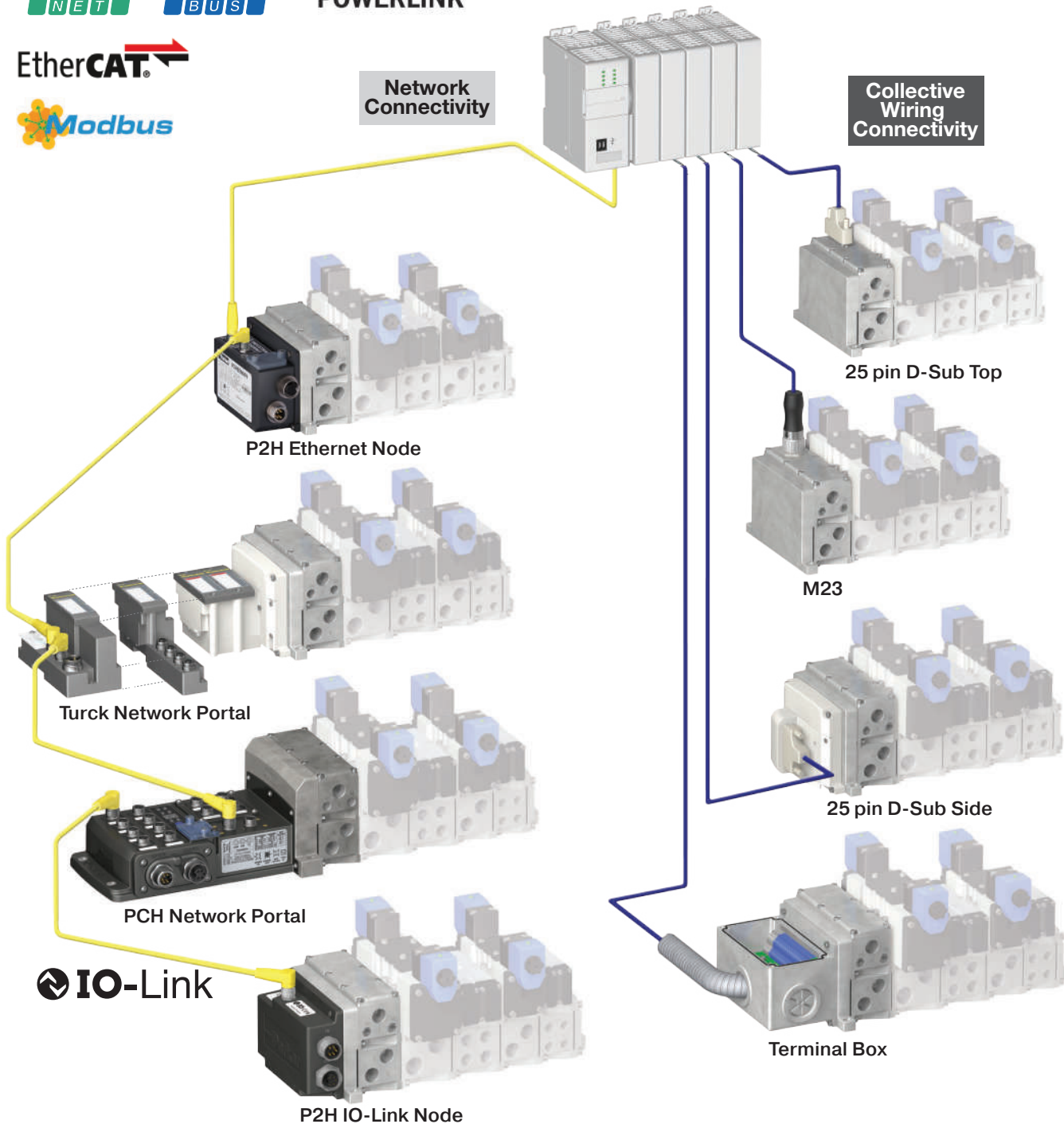

D
Subbase & Manual Valves
H Series Micro
Modulflex Series
H Series ISO
Network Connectivity
DX ISOMAX Series
Valvair II Series

Industrial Ethernet protocol offerings differ by product line



For inventory, lead times, and kit lookup, visit www.pdnplu.com

D73

Parker Hannifin Corporation
 Pneumatic Division
 Richland, Michigan
www.parker.com/pneumatics

Two easy ways to order H Universal

1 Online Configuration

Navigate to the landing page
www.parker.com/pdn/HSeriesISO

Customize your manifold assembly
Create and save a unique assembled part number
Generate a CAD model



OR

2 Order Components

A Select Endplate Kit
Includes Left and Right Hand Endplate

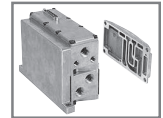
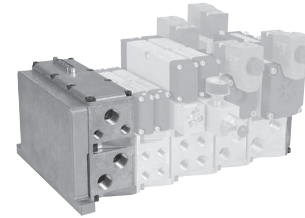

B Select Valve Stations
Valves (size HB, HA, H1 or H2)
Blanking Plate

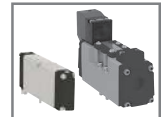
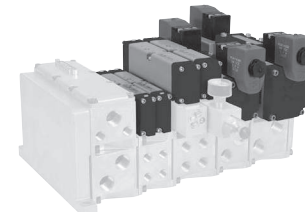

C Select Valve Manifold Segments
Manifold (size HB, HA, H1 or H2)
Air Supply Module

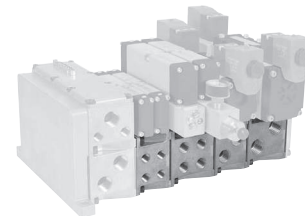

D Select Sandwich Accessories
Sandwich Regulators
Sandwich Flow Control
Pilot Exhaust

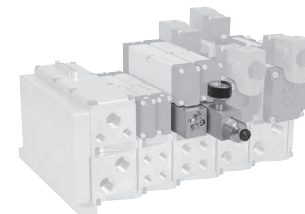









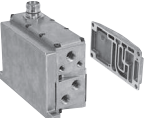

D	Subbase & Manual Valves
	H Series Micro
	Modulflex Series
	H Series ISO
	Network Connectivity
	DX ISOMAX Series
	Valvair II Series

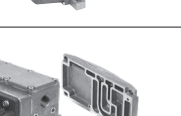

For inventory, lead times, and kit lookup, visit www.pdnplu.com

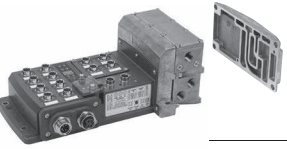
End Plate Kits - Universal for use with HB, HA, H1 H2

	Electrical option	NPT port	BSPP port
	25-pin, D-Sub Side, 24 address	PSHU20L100P	PSHU20L101P
	25-pin, D-Sub Top, 24 address	PSHU20L200P	PSHU20L201P
	19-pin, round, Brad Harrison, 16 address	PSHU20L300P	PSHU20L301P
	12-pin, M23, 8 address	PSHU20L400P	PSHU20L401P
	19-pin, M23, 16 address	PSHU20M200P	PSHU20M201P
	Terminal box, 32 address	PSHU20L500P	PSHU20L501P
<div style="display: flex; flex-direction: column; align-items: flex-start;"> <div style="margin-bottom: 10px;"></div> <div style="margin-bottom: 10px;"></div> <div style="margin-bottom: 10px;"></div> <div></div> </div> <div style="margin-top: 5px;"> <p>Class A</p> <p>Class B</p> </div>	P2H IO Link Class B, standard version, 24 address	PSHU20N200P	PSHU20N201P
	P2H IO Link Class B, safe version, 24 address	PSHU20S200P	PSHU20S201P
	P2H IO Link Class A, 4-pin safe version, 24 address	PSHU20S400P	PSHU20S401P
	P2H IO Link Class A, 5-pin safe version, 24 address	PSHU20S500P	PSHU20S501P
	P2H Ethernet Node, 32 addresses, EtherNet/IP™	PSHU20P200PE000A-P4	PSHU20P210PE000A-P4
	P2H Ethernet Node, 32 addresses, EtherCAT	PSHU20P200PT000A-P4	PSHU20P210PT000A-P4
	P2H Ethernet Node, 32 addresses, Profinet	PSHU20P200PN000A-P4	PSHU20P210PN000A-P4
	PCH Network Portal, 32 addresses with 2 Modules Variants, EtherNet/IP™	PSHU20P300PEAAN0-P4	PSHU20P301PEAAN0-P4
	PCH Network Portal, 32 addresses, with Modules Variants, EtherNet/IP™	PSHU20P300PEAAB0-P5	PSHU20P301PEAAB0-P5
	Turck Network with valve driver module, 16 address	PSHU20T100P	PSHU20T101P
	Turck Network with valve driver module, 32 address	PSHU20T200P	PSHU20T201P

 Most popular.



For inventory, lead times, and kit lookup, visit www.pdnplu.com

D75

Parker Hannifin Corporation
Pneumatic Division
Richland, Michigan
www.parker.com/pneumatics

D

Subbase & Manual Valves

H Series Micro

Modulfex Series







H Series ISO

Network Connectivity

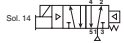
DX ISOMAX Series

Valvair II Series

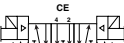



Valve - 15407-2, Plug-in, Size 18mm (HB)

Symbol	Type	Cv	Operator	Voltage	Pilot	Non-Locking	Locking						
	4-way, 2-position, spring return	0.55	Single solenoid	24 VDC	Internal	HBEVXBG0G9A	HBEVXBH0G9A						
					External	HBEVXLG0G9A	HBEVXLH0G9A						
						4-way, 2-position, air return	0.55	Single solenoid	24 VDC	Internal	HB1VXBG0G9A	HB1VXBH0G9A	
										External	HB1VXLG0G9A	HB1VXLH0G9A	
										120 VAC	Internal	HB1VXBG023A	HB1VXBH023A
											External	HB1VXLG023A	HB1VXLH023A
	4-way, 2-position	0.55	Double solenoid	24 VDC	Internal	HB2VXBG0G9A	HB2VXBH0G9A						
					External	HB2VXLG0G9A	HB2VXLH0G9A						
					120 VAC	Internal	HB2VXBG023A	HB2VXBH023A					
						External	HB2VXLG023A	HB2VXLH023A					
							4-way, 3-position, all ports blocked	0.5	Double solenoid	24 VDC	Internal	HB5VXBG0G9A	HB5VXBH0G9A
											External	HB5VXLG0G9A	HB5VXLH0G9A
120 VAC	Internal	HB5VXBG023A	HB5VXBH023A										
	External	HB5VXLG023A	HB5VXLH023A										
		4-way, 3-position, center exhaust	0.5	Double solenoid	24 VDC						Internal	HB6VXBG0G9A	HB6VXBH0G9A
											External	HB6VXLG0G9A	HB6VXLH0G9A
120 VAC						Internal	HB6VXBG023A	HB6VXBH023A					
						External	HB6VXLG023A	HB6VXLH023A					
							4-way, 3-position, pressure center	0.5	Double solenoid	24 VDC	Internal	HB7VXBG0G9A	HB7VXBH0G9A
											External	HB7VXLG0G9A	HB7VXLH0G9A
120 VAC	Internal	HB7VXBG023A	HB7VXBH023A										
	External	HB7VXLG023A	HB7VXLH023A										
	24 VDC	Internal	HBNVXBG0G9A	HBNVXBH0G9A									
		Internal	HBNVXBG023A	HBNVXBH023A									
120 VAC	Internal	HBPVXBG0G9A	HBPVXBH0G9A										
	Internal	HBPVXBG023A	HBPVXBH023A										

Manifold Base - 2-Station, 15407-2, Plug-in, Size 18mm (HB)

End Ported Bases	Enclosure / Lead Length	Solenoid Addresses	1/8" NPT	1/8" BSPP
	Circuit board	Single solenoid - 2 address	PSHU1151J1P	PSHU1152J1P
	Circuit board	Double solenoid - 4 addresses	PSHU1151M1P	PSHU1152M1P

Accessories - 15407-2, Plug-in, Size 18mm (HB)

Accessories	Description	Part Number
	Gauge adapter kit Includes 1/8" coupling, long nipple, and gauge	PS5651160P
	Blanking plate kit	PS5634P
	Sandwich flow control for individual valve Note: Do not use with Independent sandwich regulators	PS5635P
	Sandwich supply module	1/8" NPT PS561600P
		1/8" BSPP PS561601P
	Sandwich regulator	Common Pressure PS5638155P
		Independent Pressure PS5638255P
	2-60 PSIG w/ gauge PS5638166P	PS5638266P
	5-125 PSIG w/ gauge	

 Most popular.

D
 Subbase & Manual Valves
 H Series Micro
 Modulflex Series
 H Series ISO
 Network Connectivity
 DX ISOMAX Series
 Valvair II Series







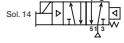

For inventory, lead times, and kit lookup, visit www.pdnplu.com

D76

Parker Hannifin Corporation
 Pneumatic Division
 Richland, Michigan
www.parker.com/pneumatics

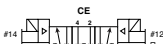
Valve - 15407-2, Plug-in, Size 26mm (HA)

Symbol	Type	Cv	Operator	Voltage	Pilot	Non-Locking	Locking
	4-way, 2-position, spring return	1.1	Single solenoid	24 VDC	Internal	HAEVXBG0G9A	HAEVXBH0G9A
					External	HAEVXLG0G9A	HAEVXLH0G9A
				120 VAC	Internal	HAEVXBG023A	HAEVXBH023A
					External	HAEVXLG023A	HAEVXLH023A
	4-way, 2-position, air return	1.1	Single solenoid	24 VDC	Internal	HA1VXBG0G9A	HA1VXBH0G9A
					External	HA1VXLG0G9A	HA1VXLH0G9A
				120 VAC	Internal	HA1VXBG023A	HA1VXBH023A
					External	HA1VXLG023A	HA1VXLH023A
	4-way, 2-position	1.1	Double solenoid	24 VDC	Internal	HA2VXBG0G9A	HA2VXBH0G9A
					External	HA2VXLG0G9A	HA2VXLH0G9A
				120 VAC	Internal	HA2VXBG023A	HA2VXBH023A
					External	HA2VXLG023A	HA2VXLH023A
				24 VDC	Internal	HA5VXBG0G9A	HA5VXBH0G9A
					External	HA5VXLG0G9A	HA5VXLH0G9A
120 VAC	Internal	HA5VXBG023A	HA5VXBH023A				
	External	HA5VXLG023A	HA5VXLH023A				
	4-way, 3-position, all ports blocked	1.0	Double solenoid	24 VDC	Internal	HA6VXBG0G9A	HA6VXBH0G9A
					External	HA6VXLG0G9A	HA6VXLH0G9A
				120 VAC	Internal	HA6VXBG023A	HA6VXBH023A
					External	HA6VXLG023A	HA6VXLH023A
				24 VDC	Internal	HA7VXBG0G9A	HA7VXBH0G9A
					External	HA7VXLG0G9A	HA7VXLH0G9A
120 VAC	Internal	HA7VXBG023A	HA7VXBH023A				
	External	HA7VXLG023A	HA7VXLH023A				
	4-way, 3-position, center exhaust	1.0	Double solenoid	24 VDC	Internal	HA6VXBG0G9A	HA6VXBH0G9A
					External	HA6VXLG0G9A	HA6VXLH0G9A
				120 VAC	Internal	HA6VXBG023A	HA6VXBH023A
					External	HA6VXLG023A	HA6VXLH023A
				24 VDC	Internal	HA7VXBG0G9A	HA7VXBH0G9A
					External	HA7VXLG0G9A	HA7VXLH0G9A
120 VAC	Internal	HA7VXBG023A	HA7VXBH023A				
	External	HA7VXLG023A	HA7VXLH023A				
	4-way, 3-position, pressure center	1.0	Double solenoid	24 VDC	Internal	HA6VXBG0G9A	HA6VXBH0G9A
					External	HA6VXLG0G9A	HA6VXLH0G9A
				120 VAC	Internal	HA6VXBG023A	HA6VXBH023A
					External	HA6VXLG023A	HA6VXLH023A
				24 VDC	Internal	HA7VXBG0G9A	HA7VXBH0G9A
					External	HA7VXLG0G9A	HA7VXLH0G9A
120 VAC	Internal	HA7VXBG023A	HA7VXBH023A				
	External	HA7VXLG023A	HA7VXLH023A				





Single Subbase - 15407-2, Plug-in, Size 26mm (HA)

Enclosure / Lead Length	Solenoid Addresses	1/4" NPT	1/4" BSPP
 Terminal strip in the base	Double solenoid - 2 addresses	PS551113CP	PS551114CP

Manifold Base - 2-Station, 15407-2, Plug-in, Size 26mm (HA)

End Ported Bases	Enclosure / Lead Length	Solenoid Addresses	1/4" NPT	1/4" BSPP
	Circuit board	Single solenoid - 2 address	PSHU1153J1P	PSHU1154J1P
	Circuit board	Double solenoid - 4 addresses	PSHU1153M1P	PSHU1154M1P

Accessories - 15407-2, Plug-in, Size 26mm (HA)

Accessories	Description	Part Number	
	Blanking plate kit	PS5534P	
	Sandwich flow control for individual valve Note : Do not use with Independent Port Sandwich Regulators	PS5535P	
	Pilot pressure control, without sensor, 1/8" BSPP	PS55XA0P	
	Sandwich supply module	1/4" NPT	PS552600P
		1/4" BSPP	PS552601P
	Sandwich regulator	Common Pressure	PS5538155P
		Independent Pressure	PS5538255P
		2-60 PSIG w/ gauge	PS5538166P
	5-125 PSIG w/ gauge	PS5538266P	

 Most popular.



For inventory, lead times, and kit lookup, visit www.pdnplu.com

D77

Parker Hannifin Corporation
 Pneumatic Division
 Richland, Michigan
www.parker.com/pneumatics

D

Subbase & Manual Valves

H Series Micro

Modulflex Series





H Series ISO

Network Connectivity

DX ISOMAX Series

Valvair II Series

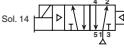
Valve - 5599-2, Plug-in, Size 1 (H1)

Symbol	Type	Cv	Operator	Voltage	Pilot	Non-Locking	Locking
 	4-way, 2-position, spring return	1.5	Single solenoid	24 VDC	Internal	H1EVXBG0B9D	H1EVXBH0B9D
					External	H1EVXXG0B9D	H1EVXXH0B9D
					Internal	H1EVXBG023D	H1EVXBH023D
					External	H1EVXXG023D	H1EVXXH023D
 	4-way, 2-position, air return	1.5	Single solenoid	24 VDC	Internal	H11VXBG0B9D	H11VXBH0B9D
					External	H11VXXG0B9D	H11VXXH0B9D
					Internal	H11VXBG023D	H11VXBH023D
					External	H11VXXG023D	H11VXXH023D

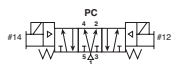
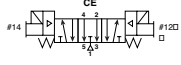
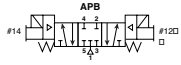



Single Subbase - 5599-2, Plug-in, Size 1 (H1)

Side Ported	Enclosure / Lead Length	Solenoid Addresses	3/8" NPT	3/8" BSPP
	Terminal strip in base	Double solenoid - 2 addresses	PS401115CDP	PS401116CDP
	6" flying leads	Double solenoid - 2 addresses	PS401115ADP	PS401116ADP
	4-pin, M12 micro connector in base, SAE / Ford wiring	Double solenoid - 2 addresses	PS4011158FDP	PS4011168FDP

Manifold Base - 5599-2, Plug-in, Size 1 (H1)

End Ported	Enclosure / Lead Length	Solenoid Addresses	3/8" NPT	3/8" BSPP
	Circuit board	Single solenoid - 1 address	PSHU1155J1P	PSHU1156J1P
	Circuit board	Double solenoid - 2 addresses	PSHU1155M1P	PSHU1156M1P

Accessories - 5599-2, Size 1 (H1)

Accessory	Description	Part Number
	Common pressure	5-125 PSIG w/ gauge PS4038166CP
	Independent pressure	5-125 PSIG w/ gauge PS4038266CP
	Blanking plate kit	PS4034CP
	Sandwich flow control	PS4035CP

A Sandwich Flow Control and Common Port Sandwich Regulator may be used together on a manifold or subbase. The Sandwich Flow Control MUST be located between the manifold/subbase and the Common Port Sandwich Regulator. Do not use with Independent Port Sandwich Regulators.

 Most popular.

D
 Subbase & Manual Valves
 H Series Micro
 Modulflex Series
 H Series ISO
 Network Connectivity
 DX ISOMAX Series
 Valvair II Series











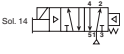

For inventory, lead times, and kit lookup, visit www.pdnplu.com

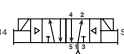
D78

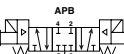
Parker Hannifin Corporation
 Pneumatic Division
 Richland, Michigan
www.parker.com/pneumatics

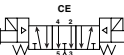
Valve - 5599-2, Plug-in, Size 2 (H2)

Symbol	Type	Cv	Operator	Voltage	Pilot	Non-Locking	Locking						
	Sol. 14 	4-way, 2-position, spring return	3.0	Single solenoid	24 VDC	Internal	H2EVXBG0B9D	H2EVXBH0B9D					
					120 VAC	External	H2EVXXG0B9D	H2EVXXH0B9D					
						Internal	H2EVXBG023D	H2EVXBH023D					
					120 VAC	External	H2EVXXG023D	H2EVXXH023D					
							Sol. 14 	4-way, 2-position, air return	3.0	Single solenoid	24 VDC	Internal	H21VXBG0B9D
					120 VAC						External	H21VXXG0B9D	H21VXXH0B9D
Internal	H21VXBG023D	H21VXBH023D											
120 VAC	External	H21VXXG023D	H21VXXH023D										
		Sol. 14 	4-way, 2-position	3.0	Double solenoid						24 VDC	Internal	H22VXBG0B9D
120 VAC											External	H22VXXG0B9D	H22VXXH0B9D
						Internal	H22VXBG023D	H22VXBH023D					
120 VAC						External	H22VXXG023D	H22VXXH023D					
							APB 	4-way, 3-position, all ports blocked	2.8	Double solenoid	24 VDC	Internal	H25VXBG0B9D
120 VAC											External	H25VXXG0B9D	H25VXXH0B9D
	Internal	H25VXBG023D	H25VXBH023D										
120 VAC	External	H25VXXG023D	H25VXXH023D										
		CE 	4-way, 3-position, center exhaust	2.8	Double solenoid						24 VDC	Internal	H26VXBG0B9D
120 VAC											External	H26VXXG0B9D	H26VXXH0B9D
						Internal	H26VXBG023D	H26VXBH023D					
120 VAC						External	H26VXXG023D	H26VXXH023D					
							PC 	4-way, 3-position, pressure center	2.8	Double solenoid	24 VDC	Internal	H27VXBG0B9D
120 VAC											External	H27VXXG0B9D	H27VXXH0B9D
	Internal	H27VXBG023D	H27VXBH023D										
120 VAC	External	H27VXXG023D	H27VXXH023D										



Single Subbase - 5599-2, Plug-in, Size 2 (H2)

Side Ported Base	Enclosure / Lead Length	Solenoid Addresses	1/2" NPT	1/2" BSPP
	Terminal strip in base	Double solenoid - 2 address	PS411117CCP	PS411118CCP
	6" flying leads	Double solenoid - 2 addresses	PS411117ACP	PS411118ACP

Manifold Base - 5599-2, Plug-in, Size 2 (H2)

End Ported	Enclosure / Lead Length	Solenoid Addresses	1/2" NPT	1/2" BSPP
	Circuit board	Single solenoid - 1 address	PSHU1157J1P	PSHU1158J1P
	Circuit board	Double solenoid - 2 addresses	PSHU1157M1P	PSHU1158M1P

Accessories - 5599-2, Size 2 (H2)

Accessory	Description	Part Number
	Common pressure	5-125 PSIG w/ gauge PS4138166CP
	Independent pressure	5-125 PSIG w/ gauge PS4138266CP
	Blanking plate kit	PS4134CP
	Sandwich flow control	PS4135CP
A Sandwich Flow Control and Common Port Sandwich Regulator may be used together on a manifold or subbase. The Sandwich Flow Control MUST be located between the manifold/subbase and the Common Port Sandwich Regulator. Do not use with Independent Port Sandwich Regulators.		

 Most popular.



For inventory, lead times, and kit lookup, visit www.pdnplu.com

D79

Parker Hannifin Corporation
Pneumatic Division
Richland, Michigan
www.parker.com/pneumatics

D

Subbase & Manual Valves

H Series Micro

Modulflex Series

H Series ISO

Network Connectivity

DX ISOMAX Series

Valvair II Series

End Plate Kit - Universal Plug-in

PSHU20 L1 0 0 P

Valve Type	
Plug-in (internal pilot)	PSHU20
Plug-in (external pilot)	PSHU2X

Thread Type	
0	NPT
1*	BSPP "G"

* BSPP conforms to ISO 1179-1 w 228-1 threads

Left Hand End Plate Type * †	
25-Pin, D-Sub (side)	L1
25-Pin, D-Sub (top)	L2
19-Pin, Round, Brad Harrison	L3
12-Pin, M23	L4
32-Point Terminal Strip	L5
19-Pin, M23	M2
P2H IO Link Class B, 24 Address, Standard Version	N2
P2H IO Link Class B, 24 Address, Safe Version	S2
P2H IO Link Class A, 24 Address, 4-Pin, Safe Version	S4
P2H IO Link Class A, 24 Address, 5-Pin, Safe Version	S5
Turck Network with valve driver module - 16 outputs ‡	T1
Turck Network with valve driver module - 32 outputs ‡	T2
-----For P2H Ethernet Node and PCH Network Portal, see next pages -----	

Right Hand End Plate Type / Port	
0	Low Profile (no ports)
1	1/2 Exhaust and Inlet Port
2	3/4 Exhaust and Inlet Port
3*	H3 Transition Plate, 1" Exhaust and Inlet, (electrical pass through)
4*	H3 Transition Plate, 1" Exhaust and Inlet, (expansion to 25th address)

* 1, 3 & 5 manifold galley blocked at transition plate. 12 & 14 pass through.

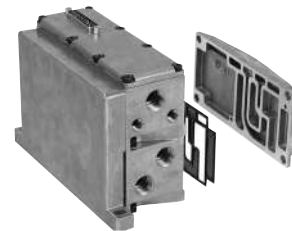



25-pin D-Sub (top) with low profile end plate shown 3.97 Cv

* 120VAC is not CSA certified.
 † Turck Network communication modules must be ordered separately. See Network Connectivity section for more information.
 ‡ PSHU11P gaskets included in each end plate kit.

Note: **PSHU20 valve type:** Supply port 1 is internally connected to manifold pilot galley 12 and 14. With valve minimum operating pressure at port 1 of the left end plate, both 12 and 14 manifold pilot galley ways can be used for piloting externally piloted valves without pressure connected to port 12 or 14.
PSHU2X valve type: Supply port 1 is isolated from manifold pilot galley 12 and 14. Pilot pressure port 14 is connected to both manifold pilot galley 12 and 14.
 Port 14 is the primary pilot port for all externally piloted H Series ISO Valves.

Right Hand End Plate

	Description	NPT Port	BSPP Port
	Right hand end plate only, low profile, 3.97 Cv	PSHU4000P	
	Right hand end plate only, high flow 1/2" ports, 6.07 Cv	PSHU4100P	PSHU4101P
	Right hand end plate only, high flow 3/4" ports, 8.35 Cv	PSHU4200P	PSHU4201P

H3 Transition Kit

	H3 transition, H3 right hand end plate, 1" ports, electrical pass through (includes gaskets & bolts)	PSHU7100P	PSHU7101P
	H3 transition, H3 right hand end plate, 1" ports, expansion to 25th address (includes gaskets & bolts)	PSHU7200P	PSHU7201P

Installation Bracket

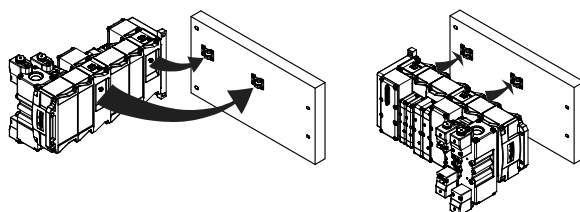

Bracket	Part Number
Bracket and Bolt (Quantity 2)	PSHU60P



For inventory, lead times, and kit lookup, visit www.pdnplu.com

D80

Parker Hannifin Corporation
 Pneumatic Division
 Richland, Michigan
www.parker.com/pneumatics

D
 Subbase & Manual Valves
 H Series Micro
 Modflex Series
 H Series ISO
 Network Connectivity
 DX ISOMAX Series
 Valvair II Series

End Plate Kit – Universal Plug-in

The P2H EtherNet Node is ordered as an endplate kit. This includes the P2H EtherNet Node, left hand air supply module, and right hand end plate. 32 pilot solenoid addresses with two choices of power source configurations.

For fully assembled manifold Add-A-Fold part number, reference page D91

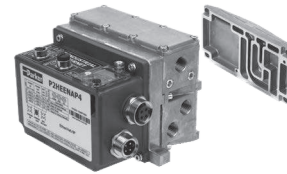

PSHU20 P2 0 0 P E 000 A – P4

Valve Type	
Plug-in (Internal pilot)	PSHU20
Plug-in (External pilot)	PSHU2X

Thread Type	
NPT	0
BSPG "G"	1

Network Connections	
EtherNet/IP™	E
EtherCAT	T
PROFINET	N
Modbus TCP	M
Powerlink	W

Power Connector	
4-pin Power IN/OUT with 1 Safe Power Capable Zone	P4
5-pin Power IN/OUT with 1 Safe Power Capable Zone	P5
5 Pin M12 L-Code IN/OUT with 1 Safe Power Capable Zone	L5

Right Hand End Plate Type / Thread Size	
Low profile (no ports)	0
1/2 Exhaust and Inlet Port	1
3/4 Exhaust and Inlet Port	2
H3 Transition Plate and End Plate (electrical pass through for plug-in valves only)	3
H3 Transition Plate and End Plate (expansion to 25th address for plug-in valves only)	4

Expansion Module / Power Source	
Power Source for Output 25-32: AUX Power	A
Power Source for Output 25-32: Logic Power	L

Power Source Selection

The P2H Node 32DO has two available power sources for addresses 24 to 31. Addresses 24 to 31 can draw their power from Auxiliary Power Pins (Power Source Option A) or Logic Power Pins (Power Source Option L). Must use Auxiliary Inlet Module with electrical expansion to access addresses 24 to 31. Address 0 to 23 is always auxiliary power source.

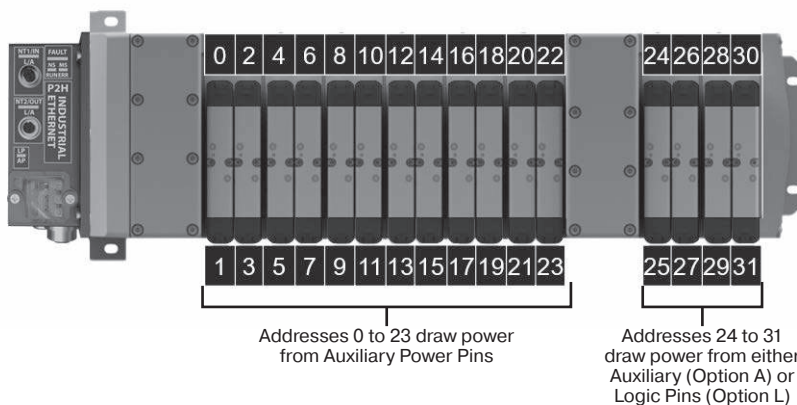

Most popular.



For inventory, lead times, and kit lookup, visit www.pdnplu.com

D81

Parker Hannifin Corporation
 Pneumatic Division
 Richland, Michigan
www.parker.com/pneumatics

D

Subbase & Manual Valves

H Series Micro

Modulflex Series

H Series ISO

Network Connectivity

DX ISOMAX Series

Valvair II Series

End Plate Kit – Universal Plug-in

The PCH Network Portal is ordered as an endplate kit. This includes the PCH Network Portal, left hand air supply module, and right hand end plate. 32 pilot solenoid addresses with configurable I/O.

For fully assembled manifold Add-A-Fold part number, reference page D92



PSHU20 P3 0 0 P E AAA 0 – P4

Valve Type	
Plug-in (Internal pilot)	PSHU20
Plug-in (External pilot)	PSHU2X

Thread Type	
NPT	0
BSPP "G"	1

Network Connections	
EtherNet/IP™	E
EtherCAT	T
PROFINET	N
Modbus TCP	M

Power Connector	
4-pin Power IN/OUT with 1 Safe Power Capable Zone	P4
5-pin Power IN/OUT with 1 Safe Power Capable Zone	P5
4-pin Power IN/IN with 2 Safe Power Zones	S4
5-pin Power IN/IN with 2 Safe Power Zones	S5

Right Hand End Plate Type / Thread Size	
Low profile (no ports)	0
1/2 Exhaust and Inlet Port	1
3/4 Exhaust and Inlet Port	2
H3 Transition Plate and End Plate (electrical pass through for plug-in valves only)	3
H3 Transition Plate and End Plate (expansion to 25th address for plug-in valves only)	4

Module Combinations		
Module Position 1	Module Position 2	Module Position 3
A	A	A
A	A	B
A	A	C
A	A	N
A	B	B
A	B	C
A	B	N
A	C	C
A	C	N
B	B	B
B	B	C
B	B	N
B	C	C
B	C	N
C	C	C
C	C	N

For any module configurations not listed, consult factory.

D	Subbase & Manual Valves
	H Series Micro
	Modulflex Series
	H Series ISO
	Network Connectivity
	DX ISOMAX Series
	Valvair II Series

Most popular.



For inventory, lead times, and kit lookup, visit www.pdnplu.com

Valve - 15407-2 Plug-in, Size 18mm (HB) & 26mm (HA)

HB 1 VX B G 0 G9 A 8P

Basic Series 15407-2	
ISO 15407-2 18mm	HB
ISO 15407-2 26mm	HA

Options	
Blank	No Options
8P	M8, PNP, Spool Sensing
8N	M8, NPN, Spool Sensing
2P	M12, PNP, Spool Sensing

* Available on HA series with operator functions 1, 2, E only

15407-2 Operator / Function	
Single Solenoid, 2-Position - Air Return	1
Double Solenoid, 2-Position	2
Double Solenoid, 3-Position - APB	5
Double Solenoid, 3-Position - CE	6
Double Solenoid, 3-Position - PC	7
Single Solenoid, 2-Position - Air Return, Spring Assist	E
Double Solenoid, Dual 3/2, NC/NC	N*
Double Solenoid, Dual 3/2, NO/NO	P*
Double Solenoid, Dual 3/2, 14 End NC – 12 end NO	Q*

15407-2 Engineering Level	
A	Current

15407-2 Voltage & Frequency				
	AC		DC	Light & Surge Suppression
	60Hz	50Hz		
G9			24	LED & Suppression
23	120	115		LED & Suppression

* Available on HB Only, must use Internal Pilot Source Option "B".

Mounting	
15407-2 Valve Less Base	VX

15407-2 Enclosure / Lead Length	
0	Valve Less Base

15407-2 Pilot Source / Pilot Exhaust	
B	Internal Pilot, Port #1 / Vented
L*	External Pilot, Port #14 / Vented

15407-2 Overrides / Lights	
G	Non-Locking, Flush, Push - W/ Light
H	Locking, Flush, Push / Turn - W/ Light

Part Number	Cable Type
RKC 4.4T-2	M12, 4 Pin Female, PVC, 2m
PKG 3M-4/S90	M8, 3 Pin Female, PUR, 4M, flying lead



HB 18mm Valve

Valve - 5599-2 Plug-in, Size H1 & H2

H1 E VX B G 0 B9 D

Basic Series 5599-2	
ISO 5599-2 Size 1	H1
ISO 5599-2 Size 2	H2

5599-2 Engineering Level	
D	Current

5599-2 Operator / Function	
Single Solenoid, 2-Position - Air Return	1
Double Solenoid, 2-Position	2
Double Solenoid, 3-Position - APB	5
Double Solenoid, 3-Position - CE	6
Double Solenoid, 3-Position - PC	7
Single Solenoid, 2-Position - Air Return, Spring Assist	E

5599-2 Voltage & Frequency				
	AC		DC	Light & Surge Suppression
	60Hz	50Hz		
42	24			
45			12	
B9			24	LED & Suppression, 3.2 Watt
F9			24	LED & Suppression, 1.3 Watt
23	120	115		LED & Suppression
57*	240			

* Single subbase only. Not available for 5599-2 manifold mount.

5599-2 Mounting	
5599-2 Valve Less Base	VX

5599-2 Enclosure / Lead length	
0	None, valve less base

5599-2 Pilot Source / Pilot Exhaust	
B	Internal Pilot, Port #1 / Vented
X*	External Pilot, Port #12 Or #14 / Vented

5599-2 Overrides / Lights		
	Voltage code	
B	42, 45, 57	Non-Locking, Flush, Push - w/o Light
C	42, 45, 57	Locking, Flush, Push / Turn - w/o Light
G	B9, F9, 23	Non-Locking, Flush, Push - w/ Light
H	B9, 23	Locking, Flush, Push / Turn - w/ Light

* Must be specified when using Sandwich Regulators.



H1 Valve shown

Most popular.



For inventory, lead times, and kit lookup, visit www.pdnplu.com

D83

Parker Hannifin Corporation
 Pneumatic Division
 Richland, Michigan
www.parker.com/pneumatics

D

Subbase & Manual Valves

H Series Micro

Moduflex Series

H Series ISO

Network Connectivity

DX ISOMAX Series

Valvair II Series

Manifold Kit - Universal Plug-in

PSHU1153 J 1 P

Mounting Style / Port Size	
HB Manifold with 1/8 NPT End Ports	PSHU1151
HB Manifold with 1/8 BSPP End Ports	PSHU1152*
HA Manifold with 1/4 NPT End Ports	PSHU1153
HA Manifold with 1/4 BSPP End Ports	PSHU1154*
H1 Manifold with 3/8 NPT End Ports	PSHU1155
H1 Manifold with 3/8 BSPP End Ports	PSHU1156*
H2 Manifold with 1/2 NPT End Ports	PSHU1157
H2 Manifold with 1/2 BSPP End Ports	PSHU1158*

* BSPP conforms to ISO 1179-1 w 228-1 threads.

Gasket Options	
1	1,3,5 Ports Open And Pilots Open
2	1,3,5 Ports Closed And Pilots Open
3	1 Closed, 3,5 Ports Open And Pilots Open
4	1 Port Open, 3,5 Ports Closed And Pilots Open
5	1,3,5 Ports Open And Pilots Closed
6	1,3,5 Ports Closed And Pilots Closed
7	1 Closed, 3,5 Ports Open And Pilots Closed
8	1 Port Open, 3,5 Ports Closed And Pilots Closed

Circuit Board Address Configuration	
J	Interconnect, Single Address
M	Interconnect, Double Address



HA manifold shown

Intermediate Air Supply - Universal Plug-in

PSHU115A T 1 P

Mounting Style / Port Size	
Intermediate Air Supply, NPT / Internal Pilot	PSHU115A
Intermediate Air Supply, BSPP / Internal Pilot	PSHU115B*
Intermediate Air Supply, NPT / External Pilot	PSHU115C
Intermediate Air Supply, BSPP / External Pilot	PSHU115D*

* BSPP conforms to ISO 1179-1 w 228-1 threads.

Gasket Options	
1	1,3,5 Ports Open And Pilots Open
2	1,3,5 Ports Closed And Pilots Open
3	1 Closed, 3,5 Ports Open And Pilots Open
4	1 Port Open, 3,5 Ports Closed And Pilots Open
5	1,3,5 Ports Open And Pilots Closed
6	1,3,5 Ports Closed And Pilots Closed
7	1 Closed, 3,5 Ports Open And Pilots Closed
8	1 Port Open, 3,5 Ports Closed And Pilots Closed

Circuit Board Address Configuration	
T	With Electrical Pass Through
E	With Electrical Expansion To 25th Address



Intermediate air supply module shown

- D
- Subbase & Manual Valves
- H Series Micro
- Modulflex Series
- H Series ISO
- Network Connectivity
- DX ISOMAX Series
- Valvair II Series



For inventory, lead times, and kit lookup, visit www.pdnplu.com

Pneumatic Zoning

Multiple pressure zones can be created by selecting alternative gaskets between individual manifold segments or an intermediate air supply module. These zones can be designed to meet different application and safety requirements on the machine. Inserting the PXM Pilot Exhaust Module into one of these zones allows control of pilot pressure for the entire zone.

Gasket Kit - Universal Manifold to Manifold

Description		Part Number
 1 – Supply & Exhaust & Pilots Open  5 – Supply & Exhaust Open, Pilots Closed  2 – Supply Closed, Exhaust & Pilots Open  6 – Supply & Pilots Closed, Exhaust Open  3 – Supply & Exhaust Closed, Pilots Open  7 – Supply & Exhaust & Pilots Closed  4 – Supply & Pilots Open, Exhaust Closed  8 – Supply Open, Exhaust & Pilots Closed	Pilots opened Pilots blocked	1 – Supply & Exhaust & Pilots Open PSHU11P 2 – Supply Closed, Exhaust & Pilots Open PSHU12P 3 – Supply & Exhaust Closed, Pilots Open PSHU13P 4 – Supply & Pilots Open, Exhaust Closed PSHU14P 5 – Supply & Exhaust Open, Pilots Closed PSHU15P 6 – Supply & Pilots Closed, Exhaust Open PSHU16P 7 – Supply & Exhaust & Pilots Closed PSHU17P 8 – Supply Open, Exhaust & Pilots Closed PSHU18P

Pilot Exhaust Module / HA Spool Sensing

PXM Pilot Exhaust Module enables an H Series HA Single Solenoid valve to control the pilot pressure to other externally piloted H Series ISO valves in the same manifold zone. The HA valve in conjunction with the PXM will remove pilot pressure to all externally piloted valves in the manifold zone when solenoid 14 is de-energized (off). Control of all externally piloted valves in the zone is disabled for both solenoid actuation and manual override until solenoid 14 of the HA valve on the PXM is energized again (on).

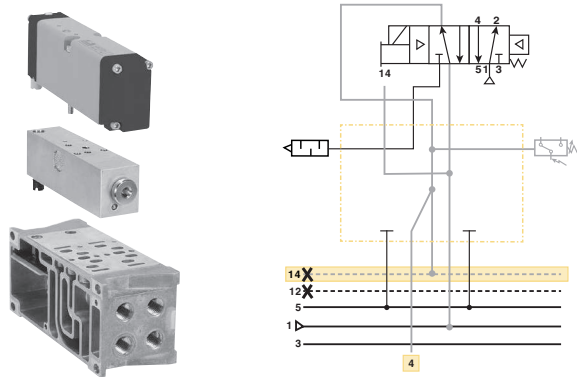

Alternatively, the HA Single Solenoid spool sensing valve can be used in place of the standard HA Valve. The spool sensing option mounts on top of the PXM and provides the added benefit of solid-state sensing of spool position to the PLC via an M8 or M12 connection. The spool sensing can be used without the PXM module for sensing only.

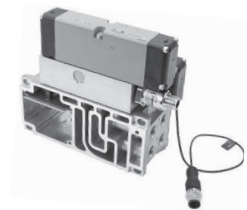
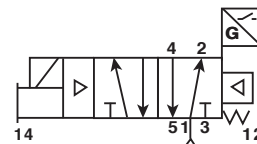

Gaskets blocking pilot pressure are required at the start of the zone the PXM is controlling. Special zoning gaskets (shown below) are available to meet any application requirement. In the example below, main pressure and exhaust pass through to the second zone, but pilot pressure is blocked. This results in the PXM providing pilot pressure for the zone after this gasket.

Part Number	Sensor Type
PS55XA0P	No sensing
PS55XM0P	Mechanical pressure switch
PS55XE0P	Solid state pressure switch

Part Number	Cable Type
RKC 4.4T-2	M12, 4 Pin Female, PVC, 2m

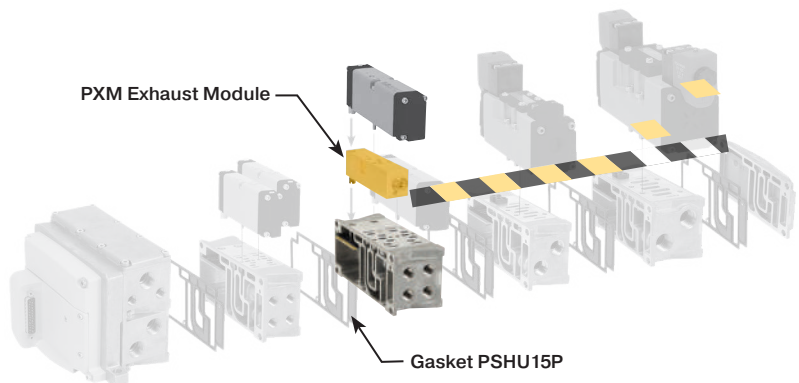

For inventory, lead times, and kit lookup, visit www.pdnplu.com

D85

Parker Hannifin Corporation
 Pneumatic Division
 Richland, Michigan
www.parker.com/pneumatics

D

Subbase & Manual Valves

H Series Micro

Modulflex Series

H Series ISO

Network Connectivity

DX ISOMAX Series

Valvair II Series

Sandwich Regulator - 15407-2, Plug-in

PS5638 1 6 6 P

Basic Series	
HB 15407-2, 18mm, Plug-in	PS5638
HA 15407-2, 26mm, Plug-in	PS5538

Regulator Function	
Common Pressure Regulator	1
Independent Pressure Regulator	2

#2 Port Regulator / Gauge*	
5	2-60 PSIG w/Gauge
6	5-125 PSIG w/Gauge

* For Common Pressure Regulator Option, Regulator Gauge callout must be the same number for both Port #4 and Port #2. (Example: 166)

#4 Port Regulator / Gauge*	
5	2-60 PSIG w/Gauge
6	5-125 PSIG w/Gauge

* For Common Pressure Regulator Option, Regulator Gauge callout must be the same number for both Port #4 and Port #2. (Example: 166)

Ordering Components

- Sandwich Regulator Kit configured for Internal Pilot as standard.
- Order valve as External Pilot.



HB - 18mm
 (Independent Dual Port Regulator shown)



HA - 26mm
 (Common Port Regulator shown)

How to Configure Sandwich Regulator / Valve Combinations

Internal Pilot Configuration of Sandwich Regulator HA, HB

Pressure in Base Port 1 feeds regulator configured for Internal Pilot which feeds valve configured for External Pilot.

Accessories	Description	Part Number
 Gauge adapter kit	Includes 1/8" coupling, long nipple, and gauge	PS5651160P

Sandwich Regulator Cv Flow Chart*

	Common Pressure Code 166				Dual Pressure Code 266			
	1-2	1-4	2-3	4-5	1-2	1-4	2-3	4-5*
HB	0.20	0.20	0.41	0.34	0.23	0.19	0.28	0.27
HA	0.41	0.43	0.87	0.89	0.42	0.45	0.68	0.66

* Regulator Port exhaust through Base Port 3.
 Note: All Cv's calculated with regulator adjusted full open.

 Most popular.

D
 Subbase & Manual Valves
 H Series Micro
 Modulflex Series
 H Series ISO
 Network Connectivity
 DX ISOMAX Series
 Valvair II Series



For inventory, lead times, and kit lookup, visit www.pdnplu.com

D86

Parker Hannifin Corporation
 Pneumatic Division
 Richland, Michigan
www.parker.com/pneumatics

Sandwich Regulator - 5599-2, Plug-in

PS4038 1 6 6 C P

Basic Series	
H1 5599-2, Plug-in	PS4038
H2 5599-2, Plug-in	PS4138

Regulator Function	
Common Pressure Regulator	1
Independent Pressure Regulator	2

#2 Port Regulator / Gauge*	
0**	Line By-Pass Plate
4	1-30 PSIG w/Gauge
5	2-60 PSIG w/Gauge
6	5-125 PSIG w/Gauge
D	Remote Pilot ISO 2 & 3 only

* For Common Pressure Regulator Option, Regulator Gauge callout must be the same number for both Port #4 and Port #2. (Example: 166)
 ** Pressure Line By-Pass Option can only be used with Independent Pressure Regulators.

#4 Port Regulator / Gauge*	
0**	Line By-Pass Plate
4	1-30 PSIG w/Gauge
5	2-60 PSIG w/Gauge
6	5-125 PSIG w/Gauge
D	Remote Pilot ISO 2 & 3 only

* For Common Pressure Regulator Option, Regulator Gauge callout must be the same number for both Port #4 and Port #2. (Example: 166)
 ** Pressure Line By-Pass Option can only be used with Independent Pressure Regulators.

Ordering Components

- Sandwich Regulator Kit configured for Internal Pilot as standard.
- Order valve as External Pilot.



H1 - Size 1
 (Independent Dual Port Regulator shown)

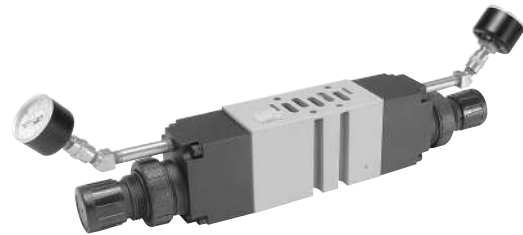

H2 - Size 2
 (Independent Dual Port Regulator shown)

How to Configure Sandwich Regulator / Valve Combinations

Internal Pilot Configuration of Sandwich Regulator H1, H2

Pressure in Base Port 1 feeds regulator configured for Internal Pilot which feeds valve configured for External Pilot.

External Pilot Configuration of Sandwich Regulator H1, H2

An External Pilot pressure in Port 12 or 14 of the base feeds thru the Sandwich Regulator 12 or 14 galley directly to the 12/14 pilot of the valve. This configuration takes an External Pilot from the 12 port of the base and passes it thru the regulator to feed the 12 galley of the valve.

Sandwich Regulator Cv Flow Chart*

	Common Pressure Code 166				Single Pressure 2 Code 206				Single Pressure 4 Code 260				Dual Pressure Code 266			
	1-2	1-4	2-3	4-5	1-2	1-4	2-3	4-5*	1-2	1-4	2-3	4-5*	1-2	1-4	2-3	4-5*
H1	0.62	0.61	1.28	1.18	0.73	0.96	0.96	0.93	0.34	0.70	0.94	0.98	0.52	0.48	0.86	0.88
H2	1.47	1.60	2.41	2.33	1.71	1.90	1.52	1.75	1.74	1.67	1.73	1.79	1.61	1.62	1.50	1.67

* Regulator Port exhaust through Base Port 3.

Note: All Cv's calculated with regulator adjusted full open.



For inventory, lead times, and kit lookup, visit www.pdnplu.com

D87

Parker Hannifin Corporation
 Pneumatic Division
 Richland, Michigan
www.parker.com/pneumatics

D

Subbase & Manual Valves

H Series Micro

Moduflex Series

H Series ISO

Network Connectivity

DX ISOMAX Series

Valvair II Series

Online Configuration

Navigate to the landing page
www.parker.com/pdn/HSeriesISO

Customize your manifold assembly

Create and save a unique assembled part number

Generate a CAD model



Add-A-Fold - Universal Plug-in

AA HU20 L1 0 0 P 04

Valve Type	
Plug-in (internal)	AAHU20
Plug-in (external)	AAHU2X

Number of Segments	
01	↓
32	

Left Hand End Plate Type * †	
25-Pin, D-Sub (side)	L1
25-Pin, D-Sub (top)	L2
19-Pin, Round, Brad Harrison	L3
12-Pin, M23	L4
32-Point Terminal Strip	L5
19-Pin, M23	M2
P2H IO Link Class B, 24 Address, Standard Version	N2
P2H IO Link Class B, 24 Address, Safe Version	S2
P2H IO Link Class A, 24 Address, 4-Pin, Safe Version	S4
P2H IO Link Class A, 24 Address, 5-Pin, Safe Version	S5
Turck Network with valve driver module - 16 outputs ‡	T1
Turck Network with valve driver module - 32 outputs ‡	T2
-----For P2H Ethernet Node and PCH Network Portal, see next pages -----	

Thread Type	
0	NPT
1*	BSPP "G"

* BSPP Conforms to ISO 1179-1 w 228-1 Threads

Right Hand End Plate Type / Port	
0	Low profile (no ports)
1	1/2 Exhaust and inlet port
2	3/4 Exhaust and inlet port
3*	H3 Transition plate, 1" exhaust and inlet, (electrical pass through)
4*	H3 Transition plate, 1" exhaust and inlet, (expansion to 25th address)

* 1, 3 & 5 manifold galley blocked at transition plate. 12 & 14 pass through.

* 120VAC is not CSA certified. Not available with 240VAC coils.
 ‡ Turck Network communication modules must be ordered separately. See Network Connectivity section for more information.
 † PSHU11P gaskets included in each end plate kit, galley ports 1, 2, 3, 12 & 14 Open.

Example

Application required a 5 segment manifold

Item	Part No.	Location
01	AAHUL200P05	
02	HB2VXBG0G9A	Valve Station 1
03	HB2VXBG0G9A	Segment 1 Valve Station 2
04	PSHU1151M1P	Manifold Base
05	HA1VXBG0G9A	Valve Station 3
06	HA2VXBG0G9A	Segment 2 Valve Station 4
07	PSHU1153M1P	Manifold Base
08	HA1VXBG0G9A	Valve Station 5
09	HA2VXBG0G9A	Segment 3 Valve Station 6
10	PSHU1153M1P	Manifold Base
11	H12VXBG0B9A	Segment 4 Valve Station 7
12	PSHU1155M1P	Manifold Base
13	H22VXBG0B9A	Segment 5 Valve Station 8
14	PSHU1157M1P	Manifold Base

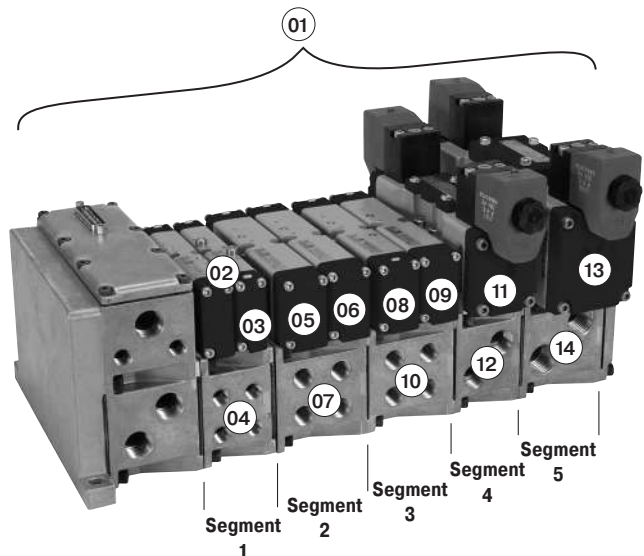

Example:
 5 segment manifold with (2) HB, (4) HA, (1) H1, and (1) H2 valve on manifold bases with 25-pin, D-Sub end plate.



For inventory, lead times, and kit lookup, visit www.pdnplu.com

Add-A-Fold – Universal Plug-in – P2H Ethernet Node

The P2H Industrial EtherNet node is a control unit capable of controlling up to 32 digital outputs (pilot solenoids), through the most popular Industrial Ethernet protocols. The P2H Ethernet is as a low-cost network connection with easy integration and simple to use diagnostics all housed in a robust IP65 weld-resistant housing.

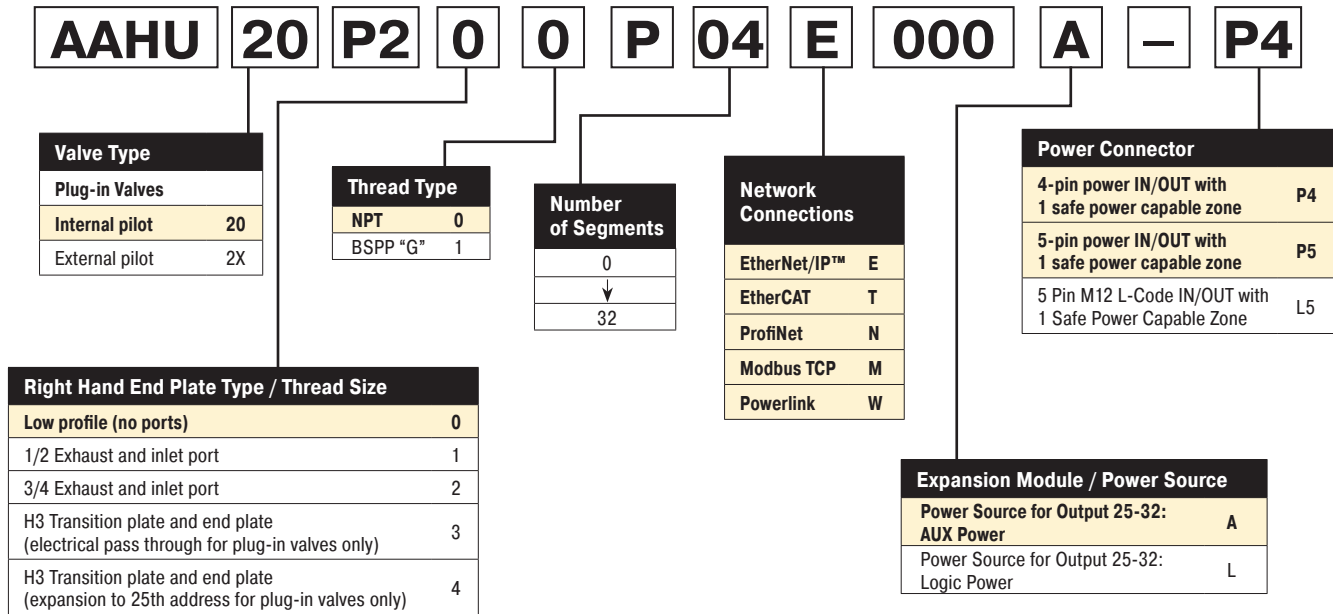

Example

Application required a 4 segment manifold

Item	Part No.	Location
01	AAHU20P200P04E000A-P4	
02	HB2VXBG0G9A	Valve Station 1
03	HB2VXBG0G9A	Segment 1 Valve Station 2
04	PSHU1151M1P	Manifold Base
05	HA1VXBG0G9A	Valve Station 3
06	HA2VXBG0G9A	Segment 2 Valve Station 4
07	PSHU1153M1P	Manifold Base
08	H12VXBG0B9A	Valve Station 5
09	PSHU1155M1P	Segment 3 Manifold Base
10	H2222VXBG0B9A	Valve Station 6
11	PSHU1157M1P	Segment 4 Manifold Base

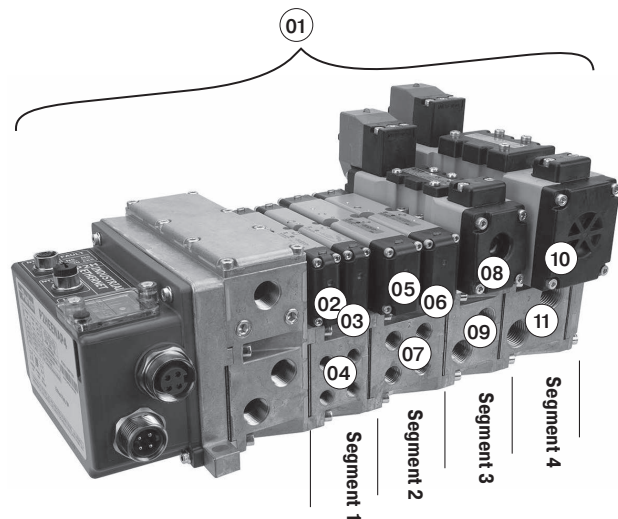

Example:
 5 segment manifold with (2) HB, (2) HA, (1) H1, and (1) H2 valve on manifold bases with P2H Ethernet Node end plate.



For inventory, lead times, and kit lookup, visit www.pdnplu.com

D89

Parker Hannifin Corporation
 Pneumatic Division
 Richland, Michigan
www.parker.com/pneumatics

D

Subbase & Manual Valves

H Series Micro

Modulflex Series

H Series ISO

Network Connectivity

DX ISOMAX Series

Valvair II Series

Add-A-Fold – Universal Plug-in – PCH Network Portal

The PCH Network Portal redefines and revolutionizes machine I/O (Inputs and Outputs). The PCH Portal was engineered for the open protocol IO-Link A and IO-Link B devices as well as configurable inputs/outputs with true PNP/NPN circuitry switching on each port for easy machine design changes. The integrated configurability gives the user flexibility in designing I/O architecture. The PCH Network Portal is designed for general pneumatic control of industrial machinery on an Ethernet network for all types of automated industrial equipment.



AAHU 20 P3 0 0 P 04 E AAA 0 - P4

Valve Type	
Plug-in Valves	
Internal pilot	20
External pilot	2X

Thread Type	
NPT	0
BSPP "G"	1

Number of Segments	
	0
	↓
	32

Network Connections	
EtherNet/IP™	E
EtherCAT	T
ProfiNet	N
Modbus TCP	M

Module Combinations		
Module Position 1	Module Position 2	Module Position 3
A	A	A
A	A	B
A	A	C
A	A	N
A	B	B
A	B	C
A	B	N
A	C	C
A	C	N
B	B	B
B	B	C
B	B	N
B	C	C
B	C	N
C	C	C
C	C	N

Power Connector	
4-pin power IN/OUT with 1 safe power capable zone	P4
5-pin power IN/OUT with 1 safe power capable zone	P5
4-pin power IN/IN with 2 safe power zones	S4
5-pin power IN/IN with 2 safe power zones	S5

Right Hand End Plate Type / Thread Size	
Low profile (no ports)	0
1/2 Exhaust and inlet port	1
3/4 Exhaust and inlet port	2
H3 Transition plate and end plate (electrical pass through for plug-in valves only)	3
H3 Transition plate and end plate (expansion to 25th address for plug-in valves only)	4

For any module configurations not listed, consult factory.

Example

Application required a 4 segment manifold

Item	Part No.	Location
01	AAHU20P300P04EAAA0-P4	
02	HB2VXBG0G9A	Valve Station 1
03	HB2VXBG0G9A	Segment 1 Valve Station 2
04	PSHU1151M1P	Manifold Base
05	HA1VXBG0G9A	Valve Station 3
06	HA2VXBG0G9A	Segment 2 Valve Station 4
07	PSHU1153M1P	Manifold Base
08	H12VXBG0B9A	Segment 3 Valve Station 5
09	PSHU1155M1P	Manifold Base
10	H2222VXBG0B9A	Segment 4 Valve Station 6
11	PSHU1157M1P	Manifold Base

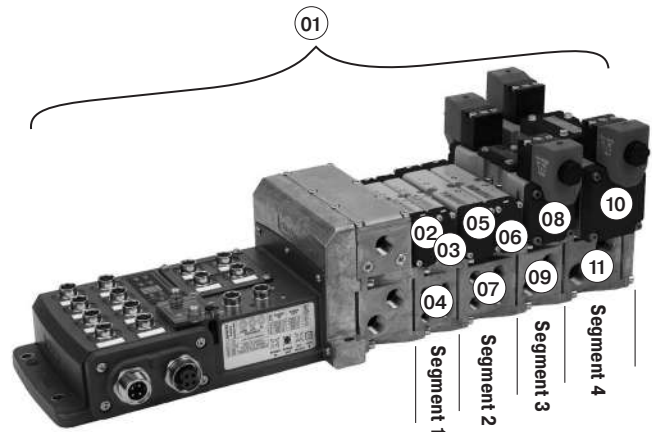

Example:
 5 segment manifold with (2) HB, (2) HA, (1) H1, and (1) H2 valve on manifold bases with PCH Network Portal end plate.

D
 Subbase & Manual Valves
 H Series Micro
 Modflex Series
 H Series ISO
 Network Connectivity
 DX ISOMAX Series
 Valvair II Series



For inventory, lead times, and kit lookup, visit www.pdnplu.com

D90

Parker Hannifin Corporation
 Pneumatic Division
 Richland, Michigan
www.parker.com/pneumatics

Subbase Kit - Plug-in

PS55 **1113** **C** **P**

Series	
HA Subbase	PS55
H1 Subbase	PS40
H2 Subbase	PS41

Engineering Level	
Blank	HA Series
D	H1 Series
C	H2 Series

Mounting Style / Port Size	
HA Series	
1/4 NPT side ports	1113
1/4 BSPP side ports	1114*
1/4 NPT bottom / side ports	1123
1/4 BSPP bottom / side ports	1124*
H1 Series	
3/8 NPT side ports	1115
3/8 BSPP side ports	1116*
H2 Series	
1/2 NPT side ports	1117
1/2 BSPP side ports	1118*

Wiring Options	
Blank	None
C †	Chrysler
F †	SAE / Ford
G †	General Motors

† Not available on HA series.

Enclosures / Lead Length	
Individually Wired Base*	
7 †	3-Pin mini connector in base
8 †	4-Pin M12 micro connector in base
9 †	5-Pin mini connector in base
A †	6" Leads
C	Terminal block

* Use plate with no connection.

† Must specify valve auto wiring option "C", "F", or "G".

‡ Not available on HA series.

* BSPP conforms to ISO 1179-1 w 228-1 threads.



HA subbase shown

D

Subbase & Manual Valves

H Series Micro

Moduflex Series

H Series ISO

Network Connectivity

DX ISOMAX Series

Valvair II Series













For inventory, lead times, and kit lookup, visit www.pdnplu.com

D91

Parker Hannifin Corporation
 Pneumatic Division
 Richland, Michigan
www.parker.com/pneumatics

End Plate Kit - Plug-in, 5599-2, Size 3 (H3) * Not compatible with H Universal

Electrical Option	NPT Port	BSP Port
 No connector - use with individually wired base	PS4231010DP	PS4231011DP
 25-pin, D-sub	PS4220L20DP	PS4220L21DP
 19-pin, round, Brad Harrison	PS4220L30DP	PS4220L31DP
 12-pin, M23	PS4220L40DP	PS4220L41DP
 19-pin, M23	PS4220M20DP	PS4220M21DP
 Turck Network with valve driver module - 16 address	PS4220T10DP	PS4220T11DP
 Turck Network with valve driver module - 24 address	PS4220T20DP	PS4220T21DP
 P2H IO Link Class B, standard version, 24 address	PS4220N20DP	PS4220N21DP
 P2H IO Link Class B, safe version, 24 address	PS4220S20DP	PS4220S21DP
 P2H IO Link Class A, 4-pin safe version, 24 address	PS4220S40DP	PS4220S41DP
 P2H IO Link Class A, 5-pin safe version, 24 address	PS4220S50DP	PS4220S51DP

Turck Network Node communication modules must be ordered separately. See Network Connectivity Section for more information.
 Note: For cable part numbers and pin out information see Network Connectivity Accessories.

D

Subbase & Manual Valves

H Series Micro

Modulflex Series

H Series ISO

Network Connectivity

DX ISOMAX Series

Valvair II Series

 Most popular.



For inventory, lead times, and kit lookup, visit www.pdnplu.com

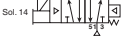
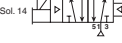
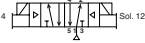
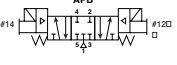
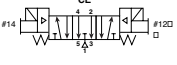
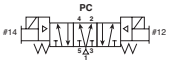

Valve - 5599-2, Plug-in, Size 3 (H3)

Symbol	Type	Cv	Operator	Voltage	Pilot	Non-locking	Locking
	4-way, 2-position, spring return	6.0	Single solenoid	24 VDC	Internal	H3EVXBG0B9D	H3EVXBH0B9D
					External	H3EVXXG0B9D	H3EVXXH0B9D
				120 VAC	Internal	H3EVXBG023D	H3EVXBH023D
					External	H3EVXXG023D	H3EVXXH023D
	4-way, 2-position, air return	6.0	Single solenoid	24 VDC	Internal	H31VXBG0B9D	H31VXBH0B9D
					External	H31VXXG0B9D	H31VXXH0B9D
				120 VAC	Internal	H31VXBG023D	H31VXBH023D
					External	H31VXXG023D	H31VXXH023D
	4-way, 2-position	6.0	Double solenoid	24 VDC	Internal	H32VXBG0B9D	H32VXBH0B9D
					External	H32VXXG0B9D	H32VXXH0B9D
				120 VAC	Internal	H32VXBG023D	H32VXBH023D
					External	H32VXXG023D	H32VXXH023D
	4-way, 3-position, all ports blocked	5.0	Double solenoid	24 VDC	Internal	H35VXBG0B9D	H35VXBH0B9D
					External	H35VXXG0B9D	H35VXXH0B9D
				120 VAC	Internal	H35VXBG023D	H35VXBH023D
					External	H35VXXG023D	H35VXXH023D
	4-way, 3-position, center exhaust	5.0	Double solenoid	24 VDC	Internal	H36VXBG0B9D	H36VXBH0B9D
					External	H36VXXG0B9D	H36VXXH0B9D
				120 VAC	Internal	H36VXBG023D	H36VXBH023D
					External	H36VXXG023D	H36VXXH023D
	4-way, 3-position, pressure center	5.0	Double solenoid	24 VDC	Internal	H37VXBG0B9D	H37VXBH0B9D
					External	H37VXXG0B9D	H37VXXH0B9D
				120 VAC	Internal	H37VXBG023D	H37VXBH023D
					External	H37VXXG023D	H37VXXH023D

Subbase - Single 5599-2, Plug-in, Size 3 (H3)

Side Ported Base	Enclosure / Lead Length	Solenoid Addresses	3/4" NPT	3/4" BSPP
	Terminal strip in base	Double solenoid - 2 address	PS42119CCP	PS421110CCP
	6" flying leads	Double solenoid - 2 addresses	PS421119ACP	PS421110ACP

Manifold Base - 5599-2, Plug-in, Size 3 (H3)

Bottom / End Ported Bases	Enclosure / Lead Length	Solenoid Addresses	3/4" NPT	3/4" BSPP
	Circuit board	Double solenoid - 2 addresses	PS421169MCP	PS421160MCP
	Terminal strip in base	Double solenoid - 2 address	PS421169CCP	PS421160CCP
	6" flying leads	Double solenoid - 2 addresses	PS421169ACP	PS421160ACP
	Circuit board	Double solenoid - 2 addresses	PS421159MCP	PS421150MCP
	Terminal strip in base	Double solenoid - 2 address	PS421159CCP	PS421150CCP
	6" flying leads	Double solenoid - 2 addresses	PS421159ACP	PS421150ACP

 Most popular.



For inventory, lead times, and kit lookup, visit www.pdnplu.com

D93

Parker Hannifin Corporation
 Pneumatic Division
 Richland, Michigan
www.parker.com/pneumatics

D

Subbase & Manual Valves

H Series Micro

Modulflex Series





H Series ISO

Network Connectivity

DX ISOMAX Series

Valvair II Series

Accessories - 5599-2, Size 3 (H3)

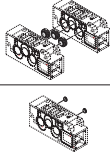
Accessory	Description	Part Number
 <p>Sandwich regulator</p>	Common pressure 5-125 PSIG w/ gauge	PS4238166CP
	Independent pressure 5-125 PSIG w/ gauge	PS4238266CP
 <p>Blanking plate kit</p>		PS4234CP
 <p>Sandwich flow control</p> <p>A Sandwich Flow Control and Common Port Sandwich Regulator may be used together on a manifold or subbase. The Sandwich Flow Control MUST be located between the manifold/subbase and the Common Port Sandwich Regulator. Do not use with Independent Port Sandwich Regulators.</p>		PS4235CP
 <p>Manifold to manifold gasket kits</p>		PS4213P
 <p>Manifold isolation kit</p>	Main galley (1, 3, 5)	PS4232CP
	Pilot galley	PS4033CP

D

Subbase & Manual
 Valves

H Series
 Micro

Modulflex
 Series

H Series
 ISO

Network
 Connectivity

DX ISOMAX
 Series

Valvair II
 Series

 Most popular.



For inventory, lead times, and kit lookup, visit www.pdnplu.com

D94

Parker Hannifin Corporation
 Pneumatic Division
 Richland, Michigan
www.parker.com/pneumatics

End Plate Kit - Plug-in, 5599-2, Size 3 (H3) * Not compatible with H Universal

PS42 20L2 0 D P

Basic Series	
ISO 5599, Size 3	PS42

Engineering Level	
D	Current

Options †	
25-Pin, D-Sub	20L2*
19-Pin, Round, Brad Harrison	20L3
12-Pin, M23	20L4
19-Pin, M23	20M2
P2H IO Link Class B, 24 Address, Standard Version	20N2
P2H IO Link Class B, 24 Address, Safe Version	20S2
P2H IO Link Class A, 24 Address, 4-Pin, Safe Version	20S4
P2H IO Link Class A, 24 Address, 5-Pin, Safe Version	20S5
Turck Network with Valve Driver Module - 16 Outputs	20T1
Turck Network with Valve Driver Module - 24 Outputs	20T2

Thread Type	
0	NPT
1*	BSPP "G"

* BSPP Conforms to ISO 1179-1 w 228-1 Threads

* 120VAC is Not CSA Rated.
 † Manifold bases must have a circuit board.
 Turck Network, communication modules must be ordered separately.
 See Network Connectivity Section for more information.

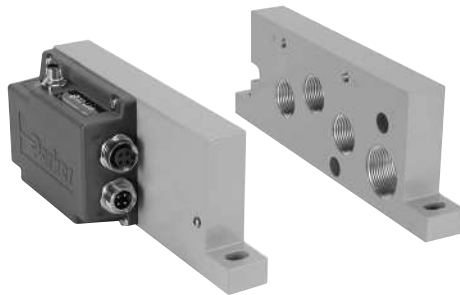

H3 P2H Class A end plate shown

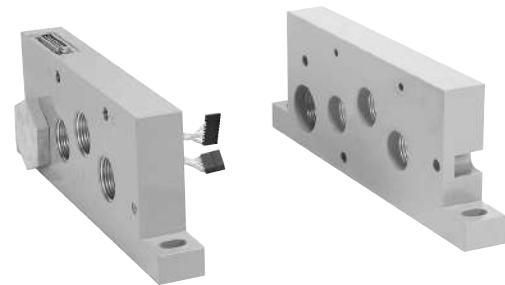

H3 25-pin D-Sub end plate shown

 Most popular.



For inventory, lead times, and kit lookup, visit www.pdnplu.com

D95

Parker Hannifin Corporation
 Pneumatic Division
 Richland, Michigan
www.parker.com/pneumatics

D

Subbase & Manual Valves

H Series Micro

Moduflex Series

H Series ISO

Network Connectivity

DX ISOMAX Series

Valvair II Series

Valve - Plug-in, 5599-2, Size 3

H3 E VX B G O B9 D

Basic Series 5599-2
 ISO 5599-2 Size 3 H3

5599-2 Engineering Level
 D Current

5599-2 Operator / Function

Single solenoid, 2-position - air return	1
Double solenoid, 2-position	2
Double solenoid, 3-position - APB	5
Double solenoid, 3-position - CE	6
Double solenoid, 3-position - PC	7
Single solenoid, 2-position - air return, spring assist	E

5599-2 Voltage & Frequency

	AC		DC	Light & surge suppression
	60Hz	50Hz		
42	24			
45			12	
B9			24	LED & suppression, 3.2 watt
F9			24	LED & suppression, 1.3 watt
23	120	115		LED & suppression
57	240			

5599-2 Mounting
 5599-2 Valve less base VX

5599-2 Pilot source / Pilot exhaust
 Internal pilot, port #1 / vented B
 External pilot, port #12 or #14 / vented X*

* Must be specified when using Sandwich Regulators.

5599-2 Enclosure / Lead length
 0 None, valve less base

5599-2 Overrides / Lights

	Voltage code	
B	42, 45, 57	Non-locking, flush, push - w/o light
C	42, 45, 57	Locking, flush, push / turn - w/o light
G	B9, F9, 23	Non-locking, flush, push - w/ light
H	B9, 23	Locking, flush, push / turn - w/ light

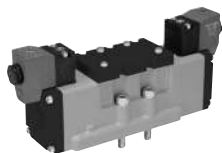

H3 Valve shown

- D
- Subbase & Manual Valves
- H Series Micro
- Modulflex Series
- H Series ISO
- Network Connectivity
- DX ISOMAX Series
- Valvair II Series

 Most popular.



For inventory, lead times, and kit lookup, visit www.pdnplu.com

D96

Parker Hannifin Corporation
 Pneumatic Division
 Richland, Michigan
www.parker.com/pneumatics

Manifold / Subbase Kit - Plug-in, 5599-2, Size 3

PS421159 **M** **C** **P**

Mounting Base Style / Port Size	
Subbase: 3/4 NPT side port	PS421119
Subbase: 3/4 BSPP side port	PS421110*
Manifold: 3/4 NPT end port	PS421159
Manifold: 3/4 BSPP end port	PS421150*
Manifold: 3/4 NPT bottom / end port	PS421169
Manifold: 3/4 BSPP bottom / end port	PS421160*

* BSPP conforms to ISO 1179-1 w 228-1 threads.

Engineering Level	
C	H3

Wiring Options	
Blank	None
C	Chrysler
F	SAE / Ford
G	General Motors

Enclosures / Lead Length	
Individually Wired Base**	
7†	3-pin mini connector in base
8†	4-pin M12 micro connector in base
9†	5-pin mini connector in base
A	6" Leads
C	Terminal block
Collective Wired Base	
M*	Circuit board, double address

* Not available with subbase kits.

** Use plate with no connection.

† Must specify valve auto wiring option "C", "F", or "G".

Note: When using the enclosure / lead length "M" option:

12VDC - Maximum number of coils energized simultaneously is 13

24VDC - Maximum number of coils energized simultaneously is 21, B9 coil
 Maximum number of coils energized simultaneously is 24, F9 coil

120VAC - Coils limited by the number of pins available in the connector
 (25-pin D-Sub = 24 coils, 19-pin Brad Harrison = 16, 12-pin M23 = 8)

240VAC - Must use "A" or "C" option, lead wires or terminal blocks



Subbase Kit

- Automotive Connectors
 Mounted in 1/2" Conduit Port
- 3-Pin - Wired for Single Solenoid
 - 4-Pin / 5-Pin - Wired for Double Solenoid



Manifold Kit

- Automotive Connectors
 Mounted in Individual Manifold Conduit Cover
- 3-Pin - Wired for Single Solenoid
 - 4-Pin / 5-Pin - Wired for Double Solenoid

Most popular.



For inventory, lead times, and kit lookup, visit www.pdnplu.com

D97

Parker Hannifin Corporation
 Pneumatic Division
 Richland, Michigan
www.parker.com/pneumatics

D

Subbase & Manual Valves

H Series Micro

Modulflex Series

H Series ISO

Network Connectivity

DX ISOMAX Series

Valvair II Series

Sandwich Regulator - Plug-in, 5599-2

PS4038 1 6 6 C P

Basic Series	
H3 5599-2, Plug-in	PS4238

Regulator Function	
Common Pressure Regulator	1
Independent Pressure Regulator	2

#2 Port Regulator / Gauge*	
0**	Line By-Pass Plate
4	1-30 PSIG w/Gauge
5	2-60 PSIG w/Gauge
6	5-125 PSIG w/Gauge
D	Remote Pilot ISO 2 & 3 only

* For Common Pressure Regulator Option, Regulator Gauge callout must be the same number for both Port #4 and Port #2. (Example: 166)
** Pressure Line By-Pass Option can only be used with Independent Pressure Regulators.

#4 Port Regulator / Gauge*	
0**	Line By-Pass Plate
4	1-30 PSIG w/Gauge
5	2-60 PSIG w/Gauge
6	5-125 PSIG w/Gauge
D	Remote Pilot ISO 2 & 3 only

Ordering Components

- Sandwich Regulator Kit configured for Internal Pilot as standard.
- Order valve as External Pilot.

D

How to Configure Sandwich Regulator / Valve Combinations

Internal Pilot Configuration of Sandwich Regulator H3
Pressure in Base Port 1 feeds regulator configured for Internal Pilot which feeds valve configured for External Pilot.

External Pilot Configuration of Sandwich Regulator H3
An External Pilot pressure in Port 12 or 14 of the base feeds thru the Sandwich Regulator 12 or 14 galley directly to the 12/14 pilot of the valve. This configuration takes an External Pilot from the 12 port of the base and passes it thru the regulator to feed the 12 galley of the valve.

Sandwich Regulator Cv Flow Chart*

	Common Pressure Code 166				Single Pressure 2 Code 206				Single Pressure 4 Code 260				Dual Pressure Code 266			
	1-2	1-4	2-3	4-5	1-2	1-4	2-3	4-5*	1-2	1-4	2-3	4-5*	1-2	1-4	2-3	4-5*
H3	2.37	2.39	4.30	4.47	2.37	2.81	2.75	3.01	2.65	2.59	2.68	2.74	2.43	2.41	3.16	3.04

* Regulator Port exhaust through Base Port 3.
Note: All Cv's calculated with regulator adjusted full open.

Subbase & Manual Valves

H Series Micro

Modulflex Series

H Series ISO

Network Connectivity

DX ISOMAX Series

Valvair II Series

Most popular.



For inventory, lead times, and kit lookup, visit www.pdnplu.com

D98

Parker Hannifin Corporation
Pneumatic Division
Richland, Michigan
www.parker.com/pneumatics

Add-A-Fold Assembly - Plug-in, 5599-2, Size 3 * Not compatible with H Universal

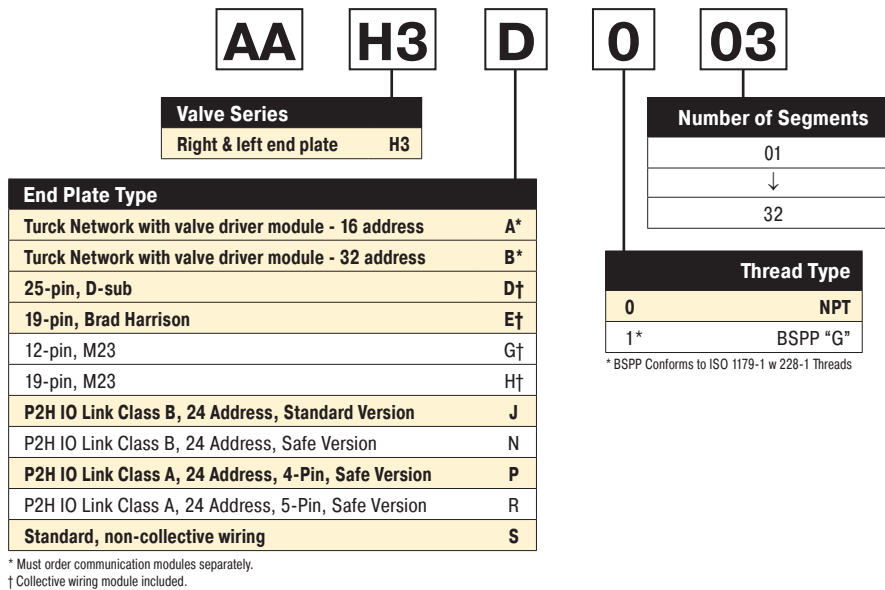

How To Order Plug-in Add-A-Fold Assemblies

- List Add-A-Fold Assembly call out. This automatically includes the end plate kit assembly.
- List complete valve, regulator, flow control and manifold base kit. List left to right, looking at the cylinder ports on the #12 end of the manifold. The left most segment is segment 1. (If a blank station is needed, list the blanking plate part number and the individual manifold part numbers for the required segment.)

Example

Application requires a 3 segment manifold and regulator on segment 3.

Item	Part No.	Location	
01	AAH3D003		
02	H31VXBG0B9D	Segment 1	Valve Station 1
03	PS421159MCP		Manifold Base
04	H32VXBG0B9D	Segment 2	Valve Station 2
05	PS421159MCP		Manifold Base
06	H32VXXG0B9D	Segment 3	Valve Station 3
07	PS4238166CP		Sandwich regulator
08	PS421159MCP		Manifold Base

NOTE:
 Construct manifold assemblies from left to right while looking at the cylinder ports. Valves must be ordered as External Pilot when using Sandwich Regulator.

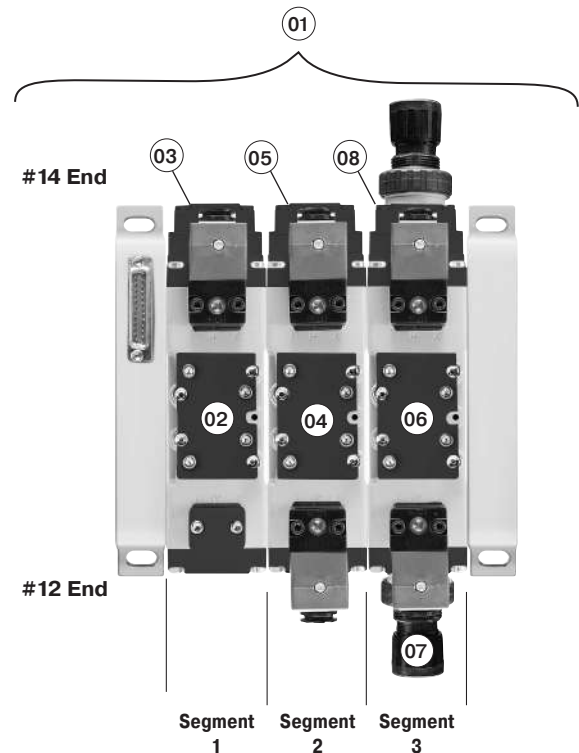

Example:
 3 segment manifold with (3) H3 valves on manifold bases and regulator at segment 3.

Most popular.





For inventory, lead times, and kit lookup, visit www.pdnplu.com

D99

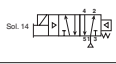
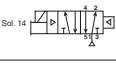
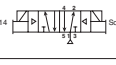
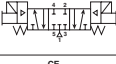
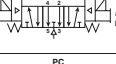

Parker Hannifin Corporation
 Pneumatic Division
 Richland, Michigan
www.parker.com/pneumatics

D
Subbase & Manual Valves
H Series Micro
Modulflex Series
H Series ISO
Network Connectivity
DX ISOMAX Series
Valvair II Series

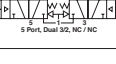
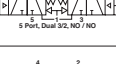
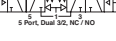





Valve - 15407-1, Non Plug-in, Size 18mm (HB)

Symbol	Type	Cv	Operator	Voltage	Pilot	Non-locking	Locking
	4-way, 2-position, spring return	0.55	Single solenoid	24 VDC	Internal	HBEXWBG2G9000FA	HBEXWBH2G9000FA
					External	HBEXWLG2G9000FA	HBEXWLH2G9000FA
	4-way, 2-position, air return	0.55	Single solenoid	24 VDC	Internal	HB1WXBG2G9000FA	HB1WXBH2G9000FA
					External	HB1WXLG2G9000FA	HB1WXLH2G9000FA
	4-way, 2-position	0.55	Double solenoid	24 VDC	Internal	HB2WXBG2G9000FA	HB2WXBH2G9000FA
					External	HB2WXLG2G9000FA	HB2WXLH2G9000FA
	4-way, 3-position, all ports blocked	0.5	Double solenoid	24 VDC	Internal	HB5WXBG2G9000FA	HB5WXBH2G9000FA
					External	HB5WXLG2G9000FA	HB5WXLH2G9000FA
	4-way, 3-position, center exhaust	0.5	Double solenoid	24 VDC	Internal	HB6WXBG2G9000FA	HB6WXBH2G9000FA
					External	HB6WXLG2G9000FA	HB6WXLH2G9000FA
	4-way, 3-position, pressure center	0.5	Double solenoid	24 VDC	Internal	HB7WXBG2G9000FA	HB7WXBH2G9000FA
					External	HB7WXLG2G9000FA	HB7WXLH2G9000FA
	3-way, 2-position, dual valve, NC/NC	0.45	Double solenoid	24 VDC	Internal	HBNWXBG2G9000FA	HBNWXBH2G9000FA
					External	HBNWXLG2G9000FA	HBNWXLH2G9000FA
	3-way, 2-position, dual valve, NO/NO	0.45	Double solenoid	24 VDC	Internal	HBPWXBG2G9000FA	HBPWXBH2G9000FA
					External	HBPWXLG2G9000FA	HBPWXLH2G9000FA
	3-way, 2-position, dual valve, NC/NO	0.45	Double solenoid	24 VDC	Internal	HBQWXBG2G9000FA	NA
					External	HBQWXLG2G9000FA	NA

Base / End Plate - 15407-1, Non Plug-in, Size 18mm (HB)

Description	NPT	BSP
 Universal manifold base 2 station, end ported	PSHU115101P	PSHU115201P
 Universal end plate Non-collective wiring	PSHU31L000P	PSHU31L001P

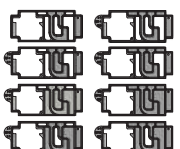
Accessories - 15407-1, Non plug-in, Size 18mm (HB)

Accessories	Description	Part Number
 Gauge adapter kit	Includes 1/8" coupling and long nipple	PS5651160P
 Blanking plate kit		PS5634P
 Sandwich flow control	Do not use with Independent Port Sandwich Regulators.	PS5642P
 Sandwich supply module	1/8" NPT	PS562600P
	1/8" BSP	PS562601P
 Sandwich regulator	2-60 PSIG w/ gauge	PS5637155P
	5-125 PSIG w/ gauge	PS5637166P
 Manifold to manifold gasket kits	Pilot Open	PSHU11P
	#1, 3, 5 ports open	PSHU15P
	Blocked #1 port	PSHU12P
	Blocked #1, 3, 5, ports	PSHU13P
 Manifold to manifold gasket kits	Blocked #3, 5 ports	PSHU14P
		PSHU18P

D

Subbase & Manual
Valves

H Series
Micro

Modulflex
Series

H Series
ISO

Network
Connectivity

DX ISOMAX
Series

Valvair II
Series







For inventory, lead times, and kit lookup, visit www.pdnplu.com

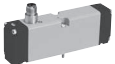
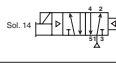
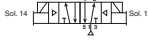

D100

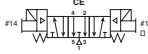
Parker Hannifin Corporation
 Pneumatic Division
 Richland, Michigan
www.parker.com/pneumatics





Valve - 15407-1, Non Plug-in, Size 26mm (HA)

Symbol	Type	Cv	Operator	Voltage	Pilot	Non-locking	Locking
	4-way, 2-position, spring return	1.1	Single solenoid	24 VDC	Internal	HAEWXBG2G9000FA	HAEWXBH2G9000FA
					External	HAEWXLG2G9000FA	HAEWXLH2G9000FA
	4-way, 2-position, air return	1.1	Single solenoid	24 VDC	Internal	HA1WXBG2G9000FA	HA1WXBH2G9000FA
					External	HA1WXLG2G9000FA	HA1WXLH2G9000FA
	4-way, 2-position	1.1	Double solenoid	24 VDC	Internal	HA2WXBG2G9000FA	HA2WXBH2G9000FA
					External	HA2WXLG2G9000FA	HA2WXLH2G9000FA
	4-way, 3-position, all ports blocked	1.0	Double solenoid	24 VDC	Internal	HA5WXBG2G9000FA	HA5WXBH2G9000FA
					External	HA5WXLG2G9000FA	HA5WXLH2G9000FA
	4-way, 3-position, center exhaust	1.0	Double solenoid	24 VDC	Internal	HA6WXBG2G9000FA	HA6WXBH2G9000FA
					External	HA6WXLG2G9000FA	HA6WXLH2G9000FA
	4-way, 3-position, pressure center	1.0	Double solenoid	24 VDC	Internal	HA7WXBG2G9000FA	HA7WXBH2G9000FA
					External	HA7WXLG2G9000FA	HA7WXLH2G9000FA

Base / End Plate - 15407-1, Non Plug-in, Size 26mm (HA)

	Description	NPT	BSPP	
	Single subbase	Side ported base, 1/4" port	PS551130P	PS551140P
	Universal manifold base	2 station, end ported	PSHU115301P	PSHU115401P
	Universal end plate	Non-collective wiring	PSHU31L000P	PSHU31L001P

Accessories - 15407-1, Non Plug-in, Size 26mm (HA)

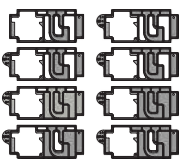
Accessories	Description	Part Number		
	Blanking plate kit	PS5534P		
	Sandwich flow control	PS5542P		
	Sandwich Flow Control and Common Port Sandwich Regulator may be sandwiched together on a manifold or subbase. The Sandwich Flow Control MUST be located between the manifold/subbase and the Common Port Sandwich Regulator. Do not use with Independent Port Sandwich Regulators.			
	Pilot pressure control, without sensor, 1/8" BSPP	PS55XXA0P		
	Sandwich supply module	1/4" NPT	PS552600P	
		1/4" BSPP	PS552601P	
	Sandwich regulator	Common Pressure	Independent Pressure	
		2-60 PSIG w/ gauge	PS5537155P	PS5537255P
	5-125 PSIG w/ gauge	PS5537166P	PS5537266P	
	Manifold to manifold gasket kits	Pilot Open	Pilot Blocked	
		#1, 3, 5 ports open	PSHU11P	PSHU15P
		Blocked #1 port	PSHU12P	PSHU16P
		Blocked #1, 3, 5, ports	PSHU13P	PSHU17P
	Blocked #3, 5 ports	PSHU14P	PSHU18P	



For inventory, lead times, and kit lookup, visit www.pdnplu.com

D101

Parker Hannifin Corporation
Pneumatic Division
Richland, Michigan
www.parker.com/pneumatics

D

Subbase & Manual Valves

H Series Micro

Modulflex Series









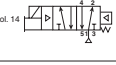

H Series ISO

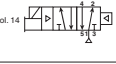
Network Connectivity

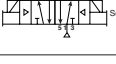

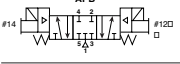



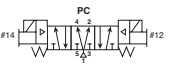

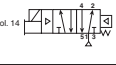

DX ISOMAX Series

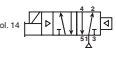
Valvair II Series

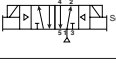

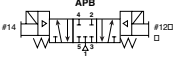

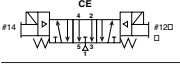
Valve with Central Connector - 5599-1, Non Plug-in, Size 1 (H1)

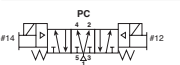
Symbol	Type	Cv	Operator	Voltage	Pilot	Non-locking	Locking	
4-Pin Central M12 Connector, 24 VDC								
		4-way, 2-position, spring return	1.5	Single solenoid	24 VDC	Internal	H1EWXBG2B9000FD	H1EWXBH2B9000FD
						External	H1EWXXG2B9000FD	H1EWXXH2B9000FD
		4-way, 2-position, air return	1.5	Single solenoid	24 VDC	Internal	H11WXBG2B9000FD	H11WXBH2B9000FD
						External	H11WXXG2B9000FD	H11WXXH2B9000FD
		4-way, 2-position	1.5	Double solenoid	24 VDC	Internal	H12WXBG2B9000FD	H12WXBH2B9000FD
						External	H12WXXG2B9000FD	H12WXXH2B9000FD
		4-way, 3-position, all ports blocked	1.2	Double solenoid	24 VDC	Internal	H15WXBG2B9000FD	H15WXBH2B9000FD
						External	H15WXXG2B9000FD	H15WXXH2B9000FD
		4-way, 3-position, center exhaust	1.2	Double solenoid	24 VDC	Internal	H16WXBG2B9000FD	H16WXBH2B9000FD
						External	H16WXXG2B9000FD	H16WXXH2B9000FD
		4-way, 3-position, pressure center	1.2	Double solenoid	24 VDC	Internal	H17WXBG2B9000FD	H17WXBH2B9000FD
						External	H17WXXG2B9000FD	H17WXXH2B9000FD

5-Pin Central 7/8" Mini Connector, 120 VAC

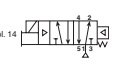
		4-way, 2-position, spring return	1.5	Single solenoid	120 VAC	Internal	H1EWXBG323000FD	H1EWXBH323000FD
						External	H1EWXXG323000FD	H1EWXXH323000FD
		4-way, 2-position, air return	1.5	Single solenoid	120 VAC	Internal	H11WXBG323000FD	H11WXBH323000FD
						External	H11WXXG323000FD	H11WXXH323000FD
		4-way, 2-position	1.5	Double solenoid	120 VAC	Internal	H12WXBG323000FD	H12WXBH323000FD
						External	H12WXXG323000FD	H12WXXH323000FD
		4-way, 3-position, all ports blocked	1.2	Double solenoid	120 VAC	Internal	H15WXBG323000FD	H15WXBH323000FD
						External	H15WXXG323000FD	H15WXXH323000FD
		4-way, 3-position, center exhaust	1.2	Double solenoid	120 VAC	Internal	H16WXBG323000FD	H16WXBH323000FD
						External	H16WXXG323000FD	H16WXXH323000FD
		4-way, 3-position, pressure center	1.2	Double solenoid	120 VAC	Internal	H17WXBG323000FD	H17WXBH323000FD
						External	H17WXXG323000FD	H17WXXH323000FD

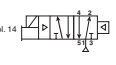
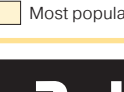
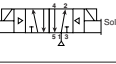
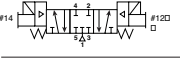
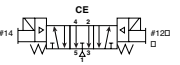
Valve with 3-Pin DIN Connector - 5599-1, Non Plug-in, Size 1 (H1)

Symbol	Type	Cv	Operator	Voltage	Pilot	Non-locking	Locking	
3-Pin DIN Connector, 24 VDC								
		4-way, 2-position, spring return	1.5	Single solenoid	24 VDC	Internal	H1EWXBBL49D	H1EWXBCL49D
						External	H1EWXXBL49D	H1EWXXCL49D
		4-way, 2-position, air return	1.5	Single solenoid	24 VDC	Internal	H11WXBBL49D	H11WXBCL49D
						External	H11WXXBL49D	H11WXXCL49D
		4-way, 2-position	1.5	Double solenoid	24 VDC	Internal	H12WXBBL49D	H12WXBCL49D
						External	H12WXXBL49D	H12WXXCL49D
		4-way, 3-position, all ports blocked	1.2	Double solenoid	24 VDC	Internal	H15WXBBL49D	H15WXBCL49D
						External	H15WXXBL49D	H15WXXCL49D
		4-way, 3-position, center exhaust	1.2	Double solenoid	24 VDC	Internal	H16WXBBL49D	H16WXBCL49D
						External	H16WXXBL49D	H16WXXCL49D
		4-way, 3-position, pressure center	1.2	Double solenoid	24 VDC	Internal	H17WXBBL49D	H17WXBCL49D
						External	H17WXXBL49D	H17WXXCL49D

 Most popular.

D
Subbase & Manual Valves
H Series Micro
Modulflex Series
H Series ISO
Network Connectivity
DX ISOMAX Series
Valvair II Series









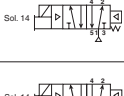
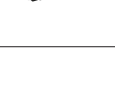
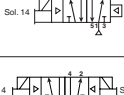

For inventory, lead times, and kit lookup, visit www.pdnplu.com

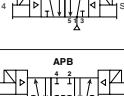

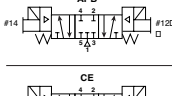
D102

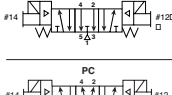
Parker Hannifin Corporation
Pneumatic Division
Richland, Michigan
www.parker.com/pneumatics



Valve with 3-Pin DIN Connector - 5599-1, Non Plug-in, Size 1 (H1) (continued)

Symbol	Type	Cv	Operator	Voltage	Pilot	Non-locking	Locking	
3-Pin DIN Connector, 120 VAC								
		4-way, 2-position, spring return	1.5	Single solenoid	120 VAC	Internal	H1EWXBBL53D	H1EWXBCL53D
						External	H1EWXXBL53D	H1EWXXCL53D
		4-way, 2-position, air return	1.5	Single solenoid	120 VAC	Internal	H11WXBBL53D	H11WXBCL53D
						External	H11WXXBL53D	H11WXXCL53D
		4-way, 2-position	1.5	Double solenoid	120 VAC	Internal	H12WXBBL53D	H12WXBCL53D
						External	H12WXXBL53D	H12WXXCL53D
		4-way, 3-position, all ports blocked	1.2	Double solenoid	120 VAC	Internal	H15WXBBL53D	H15WXBCL53D
						External	H15WXXBL53D	H15WXXCL53D
		4-way, 3-position, center exhaust	1.2	Double solenoid	120 VAC	Internal	H16WXBBL53D	H16WXBCL53D
						External	H16WXXBL53D	H16WXXCL53D
		4-way, 3-position, pressure center	1.2	Double solenoid	120 VAC	Internal	H17WXBBL53D	H17WXBCL53D
						External	H17WXXBL53D	H17WXXCL53D

Base / End Plate - 5599-1, Non Plug-in, Size 1 (H1)

	Description	NPT	BSPP
	Single subbase	Side ported, 3/8" port	PS4011150DP
	Universal manifold base	End ported	PSHU115501P
	Universal end plate	Non-collective wiring	PSHU31L000P

Accessories - 5599-1, Non Plug-in, Size 1 (H1)

Accessory	Description	Part Number
	Common pressure	PS4037166CP
	Independent pressure	PS4037266CP
	Blanking plate kit	PS4034CP
	Sandwich flow control	PS4042CP

Sandwich Flow Control and Common Port Sandwich Regulator may be sandwiched together on a manifold or subbase. The Sandwich Flow Control MUST be located between the manifold/subbase and the Common Port Sandwich Regulator. Do not use with Independent Port Sandwich Regulators.

 Most popular.



For inventory, lead times, and kit lookup, visit www.pdnplu.com

Valve with Central Connector - 5599-1, Non Plug-in, Size 2 (H2)

Symbol	Type	Cv	Operator	Voltage	Pilot	Non-locking	Locking
4-Pin Central M12 Connector, 24 VDC							
		3.0	Single solenoid	24 VDC	Internal	H2EWXBG2B9000FD	H2EWXBH2B9000FD
						External	H2EWXXG2B9000FD
		3.0	Single solenoid	24 VDC	Internal	H21WXBG2B9000FD	H21WXBH2B9000FD
						External	H21WXXG2B9000FD
		3.0	Double solenoid	24 VDC	Internal	H22WXBG2B9000FD	H22WXBH2B9000FD
						External	H22WXXG2B9000FD
		2.8	Double solenoid	24 VDC	Internal	H25WXBG2B9000FD	H25WXBH2B9000FD
						External	H25WXXG2B9000FD
		2.8	Double solenoid	24 VDC	Internal	H26WXBG2B9000FD	H26WXBH2B9000FD
						External	H26WXXG2B9000FD
		2.8	Double solenoid	24 VDC	Internal	H27WXBG2B9000FD	H27WXBH2B9000FD
						External	H27WXXG2B9000FD

5-Pin Central 7/8" Connector, 120 VAC

		3.0	Single solenoid	120 VAC	Internal	H2EWXBG323000FD	H2EWXBH323000FD
						External	H2EWXXG323000FD
		3.0	Single solenoid	120 VAC	Internal	H21WXBG323000FD	H21WXBH323000FD
						External	H21WXXG323000FD
		3.0	Double solenoid	120 VAC	Internal	H22WXBG323000FD	H22WXBH323000FD
						External	H22WXXG323000FD
		2.8	Double solenoid	120 VAC	Internal	H25WXBG323000FD	H25WXBH323000FD
						External	H25WXXG323000FD
		2.8	Double solenoid	120 VAC	Internal	H26WXBG323000FD	H26WXBH323000FD
						External	H26WXXG323000FD
		2.8	Double solenoid	120 VAC	Internal	H27WXBG323000FD	H27WXBH323000FD
						External	H27WXXG323000FD

Valve with 3-Pin DIN Connector - 5599-1, Non Plug-in, Size 2 (H2)

Symbol	Type	Cv	Operator	Voltage	Pilot	Non-locking	Locking
3-Pin DIN Connector on Coil, 24 VDC							
		3.0	Single solenoid	24 VDC	Internal	H2EWXBBL49D	H2EWXBCL49D
						External	H2EWXXBL49D
		3.0	Single solenoid	24 VDC	Internal	H21WXBBL49D	H21WXBCL49D
						External	H21WXXBL49D
		3.0	Double solenoid	24 VDC	Internal	H22WXBBL49D	H22WXBCL49D
						External	H22WXXBL49D
		2.8	Double solenoid	24 VDC	Internal	H25WXBBL49D	H25WXBCL49D
						External	H25WXXBL49D
		2.8	Double solenoid	24 VDC	Internal	H26WXBBL49D	H26WXBCL49D
						External	H26WXXBL49D
		2.8	Double solenoid	24 VDC	Internal	H27WXBBL49D	H27WXBCL49D
						External	H27WXXBL49D





Most popular.





For inventory, lead times, and kit lookup, visit www.pdnplu.com

D
 Subbase & Manual Valves
 H Series Micro
 Modulflex Series
 H Series ISO
 Network Connectivity
 DX ISOMAX Series
 Valvair II Series

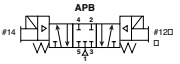
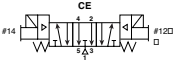
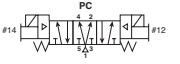

Valve with 3-Pin DIN Connector - 5599-1, Non Plug-in, Size 2 (H2) (continued)

Symbol	Type	Cv	Operator	Voltage	Pilot	Non-locking	Locking	
3-Pin DIN connector on coil, 120 VAC								
	Sol. 14 	4-way, 2-position, spring return	3.0	Single solenoid	120 VAC	Internal	H2EWXBBL53D	H2EWXBCL53D
						External	H2EWXXBL53D	H2EWXXCL53D
	Sol. 14 	4-way, 2-position, air return	3.0	Single solenoid	120 VAC	Internal	H21WXBBL53D	H21WXBCL53D
						External	H21WXXBL53D	H21WXXCL53D
	Sol. 14 	4-way, 2-position	3.0	Double solenoid	120 VAC	Internal	H22WXBBL53D	H22WXBCL53D
						External	H22WXXBL53D	H22WXXCL53D
	#14 	4-way, 3-position, all ports blocked	2.8	Double solenoid	120 VAC	Internal	H25WXBBL53D	H25WXBCL53D
						External	H25WXXBL53D	H25WXXCL53D
	#14 	4-way, 3-position, center exhaust	2.8	Double solenoid	120 VAC	Internal	H26WXBBL53D	H26WXBCL53D
						External	H26WXXBL53D	H26WXXCL53D
	#14 	4-way, 3-position, pressure center	2.8	Double solenoid	120 VAC	Internal	H27WXBBL53D	H27WXBCL53D
						External	H27WXXBL53D	H27WXXCL53D

Base / End Plate - 5599-1, Non Plug-in, Size 2 (H2)

	Description	1/2" NPT	1/2" BSPP
 Single subbase	Side ported, 1/2" port	PS4111170CP	PS4111180CP
 Universal manifold base	End ported	PSHU115701P	PSHU115801P
 Universal end plate	Non-collective wiring	PSHU31L000P	PSHU31L001P

Accessories - 5599-1, Non Plug-in, Size 2 (H2)

Accessory	Description	Part number
 Sandwich regulator	Common pressure	5-125 PSIG w/ gauge PS4137166CP
	Independent pressure	5-125 PSIG w/ gauge PS4137266CP
 Blanking plate kit		PS4134CP
 Sandwich flow control		PS4142CP

Sandwich Flow Control and Common Port Sandwich Regulator may be sandwiched together on a manifold or subbase. The Sandwich Flow Control MUST be located between the manifold/subbase and the Common Port Sandwich Regulator. Do not use with Independent Port Sandwich Regulators.

 Most popular.



For inventory, lead times, and kit lookup, visit www.pdnplu.com

D105

Parker Hannifin Corporation
Pneumatic Division
Richland, Michigan
www.parker.com/pneumatics

D

Subbase & Manual Valves

H Series Micro

Modulflex Series

H Series ISO

Network Connectivity

DX ISOMAX Series

Valvair II Series

End Plate Kit - Universal Non Plug-in



Left hand end plate

PSHU31 L0 0 0 P

Valve Type	
Non Plug-in (internal pilot)	PSHU31
Non Plug-in (external pilot)	PSHU3X

Thread Type	
0	NPT
1*	BSPG "G"

* BSPG Conforms to ISO 1179-1 w 228-1 Threads

Left Hand End Plate Type	
Non Plug-in	L0

Right Hand End Plate Type / Port	
0	Low profile (no ports)
1	1/2 Exhaust and inlet port
2	3/4 Exhaust and inlet port
5*	H3 Transition plate, 1" exhaust and inlet

* 1, 3 & 5 manifold galley blocked at transition plate. 12 & 14 pass through.

Note: PSHU31 valve type: Supply port 1 is internally connected to manifold pilot galley 12 and 14. With valve minimum operating pressure at port 1 of the left end plate, both 12 and 14 manifold pilot galley ways can be used for piloting externally piloted valves without pressure connected to port 12 or 14.
PSHU3X valve type: Supply port 1 is isolated from manifold pilot galley 12 and 14. Pilot pressure port 14 is connected to both manifold pilot galley 12 and 14.
 Port 14 is the primary pilot port for all externally piloted H Series ISO Valves.

Right Hand End Plate



Low Profile



High Flow

Description	NPT Port	BSPG Port
Right hand end plate only, low profile	PSHU4000P	
Right hand end plate only, high flow 1/2" ports	PSHU4100P	PSHU4101P
Right hand end plate only, high flow 3/4" ports	PSHU4200P	PSHU4201P

H3 Transition Kit



H3 transition, H3 right hand end plate, 1" ports (includes gaskets & bolts)

PSU7300P PSHU7301P

Valve - Non Plug-in, 15407-1, Size 18mm (HB) & 26mm (HA)

HB E WX B G 2 G9 000F A 8P

Basic Series 15407-1	
ISO 15407-1 18mm	HB
ISO 15407-1 26mm	HA

15407-1 Operator / Function	
Single solenoid, 2-position - air return	1
Double solenoid, 2-position	2
Double solenoid, 3-position - APB	5
Double solenoid, 3-position - CE	6
Double solenoid, 3-position - PC	7
Single solenoid, 2-position - air return, spring assist	E
Double solenoid, dual 3/2, NC/NC	N†
Double solenoid, dual 3/2, NO/NO	P†
Double solenoid, dual 3/2, 14 end NC - 12 end NO	Q†

† Available on HB Only, must use Internal Pilot Source Option "B".

15407-1 Mounting	
Valve less base	WX

15407-1 Pilot Source / Pilot Exhaust	
B	Internal pilot, port #1 / vented
L*	External pilot, port #14 / vented

* Must be specified when using Sandwich Regulators.

15407-1 Enclosure / Lead length	
2	4-pin, M12 micro, straight connector

15407-1 Overrides / Lights	
G	Non-locking, flush, push - w/ light
H	Locking, flush, push / turn - w/ light

15407-1 Central Connector Wiring Options	
000F	SAE / Ford, ISO 20401

15407-1 Engineering level	
A	Current

* Available on HA series with operator functions 1, 2, E only

Options	
Blank	No Options
8P	M8, PNP, Spool Sensing
8N	M8, NPN, Spool Sensing
2P	M12, PNP, Spool Sensing

Part Number	Cable Type
RKC 4.4T-2	M12, 4 Pin Female, PVC, 2m
PKG 3M-4/S90	M8, 3 Pin Female, PUR, 4M, flying lead

Most popular.



For inventory, lead times, and kit lookup, visit www.pdnplu.com

D106

Parker Hannifin Corporation
 Pneumatic Division
 Richland, Michigan
www.parker.com/pneumatics

D
 Subbase & Manual Valves
 H Series Micro
 Modflex Series
 H Series ISO
 Network Connectivity
 DX ISOMAX Series
 Valvair II Series

Valve - Non Plug-in, 5599-1, Central Connector - Size 1 & 2

H1 E WX B G 2B9 000F D

Basic Series 5599-1	
ISO 5599-1 Size 1	H1
ISO 5599-1 Size 2	H2

5599-1 Operator / Function	
Single solenoid, 2-position - air return	1
Double solenoid, 2-position	2
Double solenoid, 3-position - APB	5
Double solenoid, 3-position - CE	6
Double solenoid, 3-position - PC	7
Single solenoid, 2-position - air return, spring assist	E

5599-1 Mounting	
Valve less base	WX

5599-1 Pilot Source / Pilot Exhaust	
Internal pilot, port #1 / vented	B
External pilot, port #12 or #14 / vented	X*

* Must be specified when using Sandwich Regulators.

5599-1 Overrides / Lights	
Non-locking, flush, with light	G
Locking, flush, with light	H

5599-1 Engineering Level	
D	Current

5599-1 Central Connector Wiring Options		
000C	Chrysler	
000F*	SAE / Ford, ISO 20401	
000G	General Motors	

* Complies to ISO 20401 with Enclosure Lead Length *2*.

Enclosure / Lead Length / Voltage*				
	AC		DC	
	60Hz	50Hz		
1B9†			24	3-pin, central mini connector, 3.2 watt
1F9†+			24	3-pin, central mini connector, 1.3 watt
123†	120	115		3-pin, central mini connector
2B9			24	4-pin, central M12 micro connector, 3.2 watt
2F9+			24	4-pin, central M12 micro connector, 1.3 watt
3B9			24	5-pin, central mini connector, 3.2 watt
3F9+			24	5-pin, central mini connector, 1.3 watt
323	120	115		5-pin, central mini connector
619‡			24	2-pin, M12 micro connector on coil

* All coils include LED & suppression
† Operator function "1" or "E"
‡ Only available with wiring option "000F"
+ Override "G" only.

Valve - Non Plug-in, 5599-1, CNOMO - Size 1 & 2

H1 E WX G B L53 D

Basic Series 5599-1	
ISO 5599-1 Size 1	H1
ISO 5599-1 Size 2	H2

5599-1 Operator / Function	
Single solenoid, 2-position - air return	1
Double solenoid, 2-position	2
Double solenoid, 3-position - APB	5
Double solenoid, 3-position - CE	6
Double solenoid, 3-position - PC	7
Single solenoid, 2-position - air return, spring assist	E

5599-1 Mounting	
Valve less base	WX

5599-1 Pilot Source / Pilot Exhaust	
Internal pilot, port #1 / vented	B
External pilot, port #12 or #14 / vented	X*

* Must be specified when using Sandwich Regulators.

5599-1 Overrides / Lights	
B	Non-locking, flush, push - no light
C	Locking, flush, push / turn - no light

5599-1 Engineering Level	
D	Current

Enclosure / Lead length / Voltage				
	AC		DC	
	60Hz	50Hz		
L42	24			3-pin, 30mm DIN 43650A with CNOMO connector
L45			12	3-pin, 30mm DIN 43650A with CNOMO connector
L49			24	3-pin, 30mm DIN 43650A with CNOMO connector
L53	120	115		3-pin, 30mm DIN 43650A with CNOMO connector
L57	240			3-pin, 30mm DIN 43650A with CNOMO connector
NXX				Valve less coil

Most popular.



For inventory, lead times, and kit lookup, visit www.pdnplu.com

D107

Parker Hannifin Corporation
Pneumatic Division
Richland, Michigan
www.parker.com/pneumatics

D
Subbase & Manual Valves
H Series Micro
Modulflex Series
H Series ISO
Network Connectivity
DX ISOMAX Series
Valvair II Series

Remote Pilot - Size 18mm (HB), Size 26mm (HA), Size 1 (H1) & Size 2 (H2)

H1 **4** **WX000XX** **D**

Basic Series	
ISO 15407-1 18mm	HB
ISO 15407-1 26mm	HA*
ISO 5599-1 Size 1	H1*
ISO 5599-1 Size 2	H2*

* Must order remote pilot access plates for manifolds.

Engineering Level	
A	15407 Current
D	5599 Current

Remote Pilot Valve	
WX000XX	Remote pilot valve

15407-1 Operator / Function	
Single remote pilot, 2-position - air return	3
Double remote pilot, 2-position	4
Double remote pilot, 3-position - APB	8
Double remote pilot, 3-position - CE	9
Double remote pilot, 3-position - PC	0
Single remote pilot, 2-position - air return, spring assist	F

Note: For manifolds, end plates, and accessories, see 15407-1 & 5599-1 Non Plug-in valve section.

Note: HB 18mm Valve Remote Pilot Option only available with PL02 Individual Subbase Kits.

D

Subbase & Manual Valves

H Series Micro

Modulflex Series

H Series ISO

Network Connectivity

DX ISOMAX Series

Valvair II Series

Remote Pilot Access Plate Kit

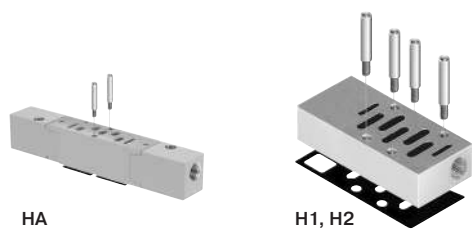

Size	Port Size	NPT	BSPP "G"
HA	1/4"	PS551500P	PS551501P
H1	1/8"	PS401500CP	PS401501CP
H2	1/8"	PS411500CP	PS411501CP

Kit includes: Pilot port access plate, gasket and mounting studs.

Most popular.



For inventory, lead times, and kit lookup, visit www.pdnplu.com

D108

Parker Hannifin Corporation
 Pneumatic Division
 Richland, Michigan
www.parker.com/pneumatics

Manifold Kit - Universal Non Plug-in

PSHU1153 **0** **1** **P**

Mounting Style / Port Size	
HB manifold with 1/8 NPT end ports	PSHU1151
HB manifold with 1/8 BSPP end ports	PSHU1152*
HA manifold with 1/4 NPT end ports	PSHU1153
HA manifold with 1/4 BSPP end ports	PSHU1154*
H1 manifold with 3/8 NPT end ports	PSHU1155
H1 manifold with 3/8 BSPP end ports	PSHU1156*
H2 manifold with 1/2 NPT end ports	PSHU1157
H2 manifold with 1/2 BSPP end ports	PSHU1158*

* BSPP conforms to ISO 1179-1 w 228-1 threads.

Gasket Options	
1	1,3,5 ports open and pilots open
2	1,3,5 ports closed and pilots open
3	1 closed, 3,5 ports open and pilots closed
4	1 port open, 3,5 ports closed and pilots open
5	1,3,5 ports open and pilots closed
6	1,3,5 ports closed and pilots closed
7	1 closed, 3,5 ports open and pilots closed
8	1 port open, 3,5 ports closed and pilots open

Circuit Board Address Configuration	
0	No interconnect



HA manifold

Intermediate Air Supply - Universal Non Plug-in

PSHU115A **0** **1** **P**

Mounting Style / Port Size	
Intermediate air supply, NPT / internal pilot	PSHU115A
Intermediate air supply, BSPP / internal pilot	PSHU115B*
Intermediate air supply, NPT / external pilot	PSHU115C
Intermediate air supply, BSPP / external pilot	PSHU115D*

* BSPP Conforms to ISO 1179-1 w 228-1 Threads.

Gasket Options	
1	1,3,5 ports open and pilots open
2	1,3,5 ports closed and pilots open
3	1 closed, 3,5 ports open and pilots closed
4	1 port open, 3,5 ports closed and pilots open
5	1,3,5 ports open and pilots closed
6	1,3,5 ports closed and pilots closed
7	1 closed, 3,5 ports open and pilots closed
8	1 port open, 3,5 ports closed and pilots open

Circuit Board Address Configuration	
0	No electrical



Intermediate air supply

 Most popular.



For inventory, lead times, and kit lookup, visit www.pdnplu.com

D109

Parker Hannifin Corporation
 Pneumatic Division
 Richland, Michigan
www.parker.com/pneumatics

D

Subbase & Manual Valves

H Series Micro

Moduflex Series

H Series ISO

Network Connectivity

DX ISOMAX Series

Valvair II Series

Pneumatic Zoning

Multiple pressure zones can be created by selecting alternative gaskets between individual manifold segments or an intermediate air supply module. These zones can be designed to meet different application and safety requirements on the machine. Inserting the PXM Pilot Exhaust Module into a one of these zones allows control of pilot pressure for the entire zone.

Gasket Kit - Universal Manifold to Manifold

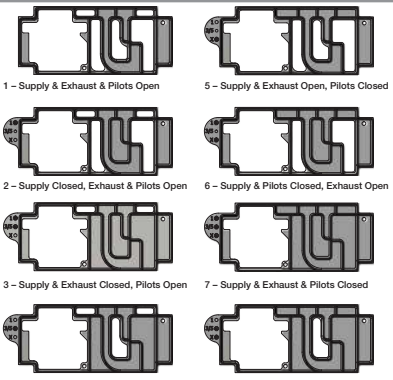
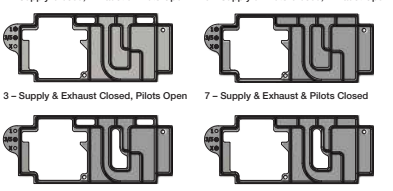
Description		Part Number
 <p>1 – Supply & Exhaust & Pilots Open 2 – Supply Closed, Exhaust & Pilots Open 3 – Supply & Exhaust Closed, Pilots Open 4 – Supply & Pilots Open, Exhaust Closed</p>	Pilots opened	PSHU11P
		PSHU12P
		PSHU13P
		PSHU14P
 <p>5 – Supply & Exhaust Open, Pilots Closed 6 – Supply & Pilots Closed, Exhaust Open 7 – Supply & Exhaust & Pilots Closed 8 – Supply Open, Exhaust & Pilots Closed</p>	Pilots blocked	PSHU15P
		PSHU16P
		PSHU17P
		PSHU18P

Pilot Exhaust Module

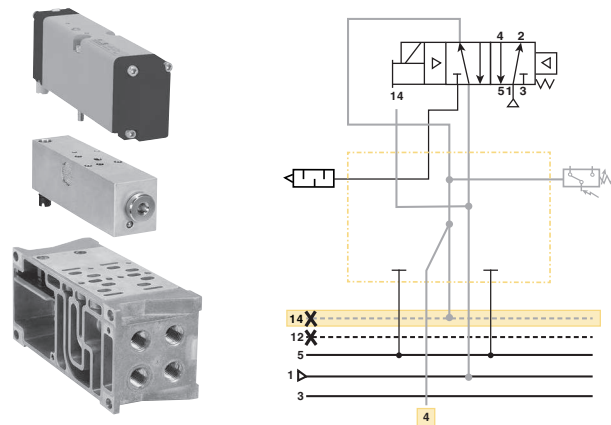

PXM Pilot Exhaust Module enables an H Series HA Single Solenoid valve to control the pilot pressure to other externally piloted H Series ISO valves in the same manifold zone. The HA valve in conjunction with the PXM will remove pilot pressure to all externally piloted valves in the manifold zone when solenoid 14 is de-energized (off). Control of all externally piloted valves in the zone is disabled for both solenoid actuation and manual override until solenoid 14 of the HA valve on the PXM is energized again (on).

Gaskets blocking pilot pressure are required at the start of the zone the PXM is controlling. Special zoning gaskets (shown below) are available to meet any application requirement. In the example below, main pressure and exhaust pass through to the second zone, but pilot pressure is blocked. This results in the PXM providing pilot pressure for the zone after this gasket.

Part Number	Sensor Type
PS55XA0P	No sensing
PS55XM0P	Mechanical pressure switch
PS55XE0P	Solid state pressure switch

Part Number	Cable Type
RKC4.4T-2	M12 cable, PVC, 2m

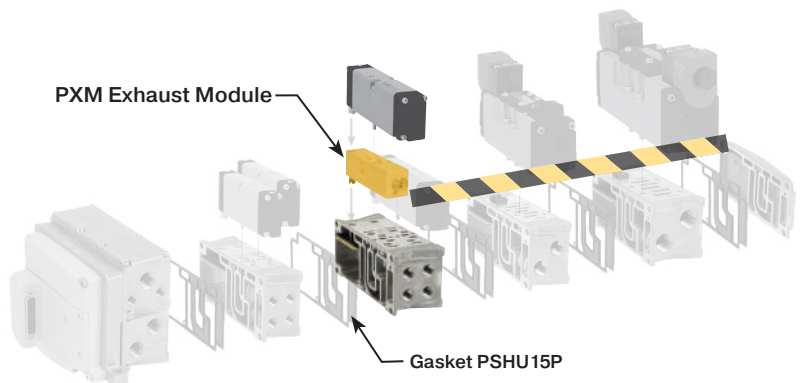

Sandwich Regulator - Non Plug-in, 15407-1

PS5637 1 6 6 P

Basic Series	
HB 15407-1, 18mm, Non Plug-In	PS5637
HA 15407-1, 26mm, Non Plug-In	PS5537

#2 Port Regulator / Gauge*	
5	2-60 PSIG w/Gauge
6	5-125 PSIG w/Gauge

* For Common Pressure Regulator Option, Regulator Gauge callout must be the same number for both Port #4 and Port #2. (Example: 166)

Regulator Function	
Common Pressure Regulator	1
Independent Pressure Regulator	2

#4 Port Regulator / Gauge*	
5	2-60 PSIG w/Gauge
6	5-125 PSIG w/Gauge

* For Common Pressure Regulator Option, Regulator Gauge callout must be the same number for both Port #4 and Port #2. (Example: 166)



HB - 18mm
 (Independent Dual Port Regulator shown)



HA - 26mm
 (Common Port Regulator shown)

Ordering Components

- Manifold or Subbase Kit required.
- Sandwich Regulator Kit configured for Internal Pilot as standard.
- Order valve as External Pilot.

How to Configure Sandwich Regulator / Valve Combinations

Internal Pilot Configuration of Sandwich Regulator HA, HB

Pressure in Base Port 1 feeds regulator configured for Internal Pilot which feeds valve configured for External Pilot.

Accessories	Description	Part Number
	Gauge adapter kit Includes 1/8" coupling, long nipple, and gauge	PS5651160P

Sandwich Regulator Cv Flow Chart*

	Common Pressure Code 166				Dual Pressure Code 266			
	1-2	1-4	2-3	4-5	1-2	1-4	2-3	4-5*
HB	0.20	0.20	0.41	0.34	0.23	0.19	0.28	0.27
HA	0.41	0.43	0.87	0.89	0.42	0.45	0.68	0.66

* Regulator Port exhaust through Base Port 3.
 Note: All Cv's calculated with regulator adjusted full open.



For inventory, lead times, and kit lookup, visit www.pdnplu.com

D111

Parker Hannifin Corporation
 Pneumatic Division
 Richland, Michigan
www.parker.com/pneumatics

D

Subbase & Manual Valves

H Series Micro

Modulflex Series

H Series ISO

Network Connectivity

DX ISOMAX Series

Valvair II Series

Sandwich Regulator - Non Plug-in, 5599-1

PS4037 1 6 6 C P

Basic Series	
H1 5599-1, Non Plug-in	PS4037
H2 5599-1, Non Plug-in	PS4137

Regulator Function	
Common Pressure Regulator	1
Independent Pressure Regulator	2

#2 Port Regulator / Gauge*	
0**	Line By-Pass Plate
4	1-30 PSIG w/Gauge
5	2-60 PSIG w/Gauge
6	5-125 PSIG w/Gauge
D	Remote Pilot ISO 2 & 3 only

* For common pressure regulator option, regulator gauge callout must be the same number for both Port #4 and Port #2. (Example: 166)

** Pressure Line by-pass option can only be used with independent pressure regulators.

#4 Port Regulator / Gauge*	
0**	Line By-Pass Plate
4	1-30 PSIG w/Gauge
5	2-60 PSIG w/Gauge
6	5-125 PSIG w/Gauge
D	Remote Pilot ISO 2 & 3 only

* For common pressure regulator option, regulator gauge callout must be the same number for both Port #4 and Port #2. (Example: 166)

** Pressure Line by-pass option can only be used with independent pressure regulators.

Ordering Components

- Sandwich regulator kit configured for internal pilot as standard.
- Order valve as external pilot.



H1 - Size 1
(Independent Dual Port Regulator shown)

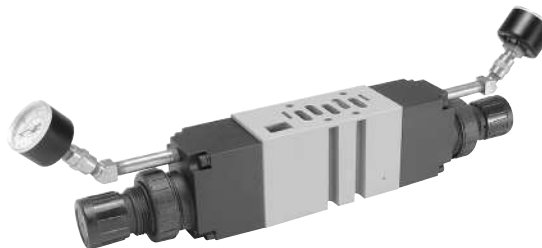

H2 - Size 2
(Independent Dual Port Regulator shown)

How to Configure Sandwich Regulator / Valve Combinations

Internal Pilot Configuration of Sandwich Regulator H1 & H2

Pressure in Base Port 1 feeds regulator configured for Internal Pilot which feeds valve configured for External Pilot.

External Pilot Configuration of Sandwich Regulator H1 & H2

An External Pilot pressure in Port 12 or 14 of the base feeds thru the Sandwich Regulator 12 or 14 galley directly to the 12/14 pilot of the valve. This configuration takes an External Pilot from the 12 port of the base and passes it thru the regulator to feed the 12 galley of the valve.

Sandwich Regulator Cv Flow Chart*

	Common Pressure Code 166				Single Pressure 2 Code 206				Single Pressure 4 Code 260				Dual Pressure Code 266			
	1-2	1-4	2-3	4-5	1-2	1-4	2-3	4-5*	1-2	1-4	2-3	4-5*	1-2	1-4	2-3	4-5*
H1	0.62	0.61	1.28	1.18	0.73	0.96	0.96	0.93	0.34	0.70	0.94	0.98	0.52	0.48	0.86	0.88
H2	1.47	1.60	2.41	2.33	1.71	1.90	1.52	1.75	1.74	1.67	1.73	1.79	1.61	1.62	1.50	1.67

* Regulator Port exhaust through Base Port 3.

Note: All Cv's calculated with regulator adjusted full open.

Most popular.



For inventory, lead times, and kit lookup, visit www.pdnplu.com

D112

Parker Hannifin Corporation
 Pneumatic Division
 Richland, Michigan
www.parker.com/pneumatics

D
 Subbase & Manual Valves
 H Series Micro
 Modflex Series
 H Series ISO
 Network Connectivity
 DX ISOMAX Series
 Valvair II Series

Online Configuration

Navigate to the landing page
www.parker.com/pdn/HSeriesISO
 Customize your manifold assembly
 Create and save a unique assembled part number
 Generate a CAD model



Add-A-Fold - Universal Non Plug-in

AAHU31 L0 0 0 P 06

Valve Type	
Non plug-in (internal)	AAHU31
Non plug-in (external)	AAHU3X

Left Hand End Plate Type	
No connector, non plug-in	L0

Right Hand End Plate Type / Port	
Low profile (no ports)	0
1/2 Exhaust and inlet port	1
3/4 Exhaust and inlet port	2
H3 Transition plate, 1" exhaust and inlet	5*

* 1, 3 & 5 manifold galley blocked at transition plate. 12 & 14 pass through.

Number of Segments	
01	
↓	
32	

Thread Type	
0	NPT
1*	BSPP "G"

* BSPP conforms to ISO 1179-1 w 228-1 threads

How To Order Plug-in Add-A-Fold Assemblies

- List Add-A-Fold Assembly call out. This automatically includes the end plate kit assembly.
- List complete valve, regulator, flow control and manifold base kit. List left to right, looking at the cylinder ports on the # 12 end of the manifold. The left most segment is segment 1. (If a blanking plate is needed, list the blanking plate part number and the individual manifold part numbers for the required segment.)

Example

Application requires a 4 segment manifold.

Item	Part No.	Location
01	AAHU31L000P04	
02	HB2WXBG2G9000FA	Segment 1
03	HB2WXBG2G9000FA	
04	PSHU115101P	Manifold base
05	HA1WXBG2G9000FA	Segment 2
06	HA2WXBG2G9000FA	
07	PSHU115301P	Manifold base
08	H12WXBG2B9000FD	Segment 3
09	PSHU115501P	
10	22WXBG2B9000FD	Segment 4
11	PSHU115701P	Manifold base

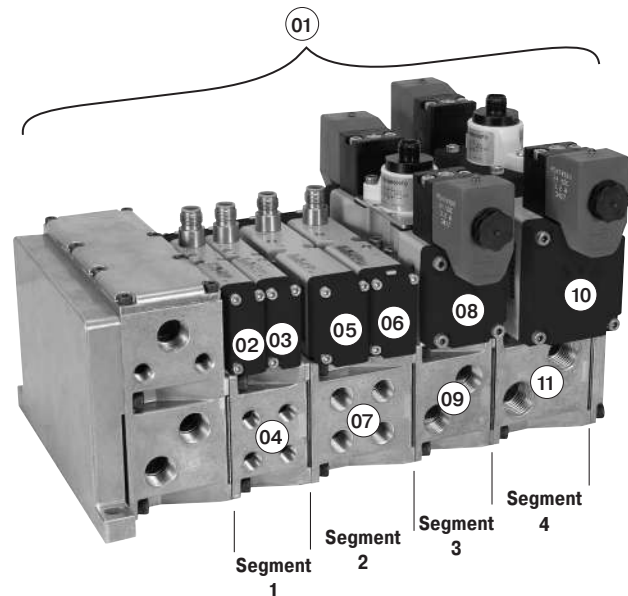

Example:
 4 segment manifold with (2) HB, (2) HA, (1) H1, and (1) H2 valve on manifold bases with low profile, NPT end plate.

Most popular.



For inventory, lead times, and kit lookup, visit www.pdnplu.com

Subbase Kit - Non Plug-in



HA non plug-in subbase shown

PS55 **1113** **0** **P**

Series	
HA Subbase	PS55
H1 Subbase	PS40
H2 Subbase	PS41

Engineering Level	
Blank	HA Series
D	H1 Series
C	H2 Series

Mounting Style / Port Size	
HA Series	
1/4 NPT side ports	1113
1/4 BSPP side ports	1114*
1/4 NPT bottom / side ports	1123
1/4 BSPP bottom / side ports	1124*
H1 Series	
3/8 NPT side ports	1115
3/8 BSPP side ports	1116*
H2 Series	
1/2 NPT side ports	1117
1/2 BSPP side ports	1118*

Enclosures / Lead Length	
0	None, No Electrical Plug

* BSPP conforms to ISO 1179-1 w 228-1 threads.

HB Series ISO 15407-1 Size 18mm (HB) Single Subbase

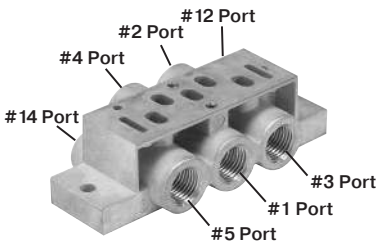

Side ported base
18mm DX02 / HB

1/8" NPT 1/8" BSPP

PL02-01-80 **PL02-01-70**

Note: Can be used for external, single, or double remote pilot.

D

Subbase & Manual Valves

H Series Micro

Modulflex Series

H Series ISO

Network Connectivity





DX ISOMAX Series

Valvair II Series





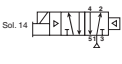

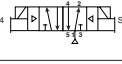
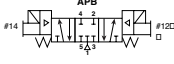
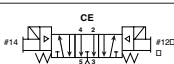
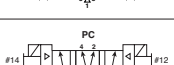
For inventory, lead times, and kit lookup, visit www.pdnplu.com

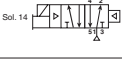

Valve with Central Connectors - 5599-1, Non Plug-in, Size 3 (H3)

Symbol	Type	Cv	Operator	Voltage	Pilot	Non-locking	Locking
4-Pin Central M12 Connector, 24 VDC							
		6.0	Single solenoid	24 VDC	Internal	H3EWXBG2B9000FD	H3EWXBH2B9000FD
						External	H3EWWXG2B9000FD
		6.0	Single solenoid	24 VDC	Internal	H31WXBG2B9000FD	H31WXBH2B9000FD
						External	H31WXXG2B9000FD
		6.0	Double solenoid	24 VDC	Internal	H32WXBG2B9000FD	H32WXBH2B9000FD
						External	H32WXXG2B9000FD
		5.0	Double solenoid	24 VDC	Internal	H35WXBG2B9000FD	H35WXBH2B9000FD
						External	H35WXXG2B9000FD
		5.0	Double solenoid	24 VDC	Internal	H36WXBG2B9000FD	H36WXBH2B9000FD
						External	H36WXXG2B9000FD
		5.0	Double solenoid	24 VDC	Internal	H37WXBG2B9000FD	H37WXBH2B9000FD
						External	H37WXXG2B9000FD

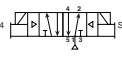
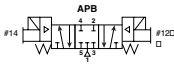
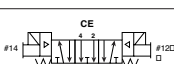
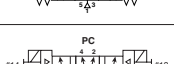
5-Pin, Central 7/8" Mini Connector, 120 VAC

		6.0	Single solenoid	120 VAC	Internal	H3EWXBG323000FD	H3EWXBH323000FD
						External	H3EWWXG323000FD
		6.0	Single solenoid	120 VAC	Internal	H31WXBG323000FD	H31WXBH323000FD
						External	H31WXXG323000FD
		6.0	Double solenoid	120 VAC	Internal	H32WXBG323000FD	H32WXBH323000FD
						External	H32WXXG323000FD
		5.0	Double solenoid	120 VAC	Internal	H35WXBG323000FD	H35WXBH323000FD
						External	H35WXXG323000FD
		5.0	Double solenoid	120 VAC	Internal	H36WXBG323000FD	H36WXBH323000FD
						External	H36WXXG323000FD
		5.0	Double solenoid	120 VAC	Internal	H37WXBG323000FD	H37WXBH323000FD
						External	H37WXXG323000FD

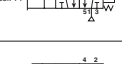
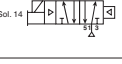
Valve with 3-Pin DIN Connectors - 5599-1, Non Plug-in, Size 3 (H3)

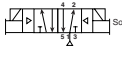
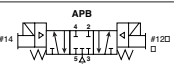
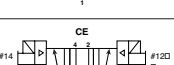
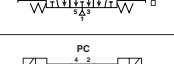
Symbol	Type	Cv	Operator	Voltage	Pilot	Non-locking	Locking
3-Pin DIN Connector on Coil, 24 VDC							
		6.0	Single solenoid	24 VDC	Internal	H3EWXBBL49D	H3EWXBCL49D
						External	H3EWWXBL49D
		6.0	Single solenoid	24 VDC	Internal	H31WXBBL49D	H31WXBCL49D
						External	H31WXXBL49D
		6.0	Double solenoid	24 VDC	Internal	H32WXBBL49D	H32WXBCL49D
						External	H32WXXBL49D
		5.0	Double solenoid	24 VDC	Internal	H35WXBBL49D	H35WXBCL49D
						External	H35WXXBL49D
		5.0	Double solenoid	24 VDC	Internal	H36WXBBL49D	H36WXBCL49D
						External	H36WXXBL49D
		5.0	Double solenoid	24 VDC	Internal	H37WXBBL49D	H37WXBCL49D
						External	H37WXXBL49D

 Most popular.



For inventory, lead times, and kit lookup, visit www.pdnplu.com

D115

Parker Hannifin Corporation
Pneumatic Division
Richland, Michigan
www.parker.com/pneumatics

D

Subbase & Manual Valves

H Series Micro

Modulux Series





H Series ISO

Network Connectivity

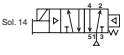

DX ISOMAX Series

Valvair II Series

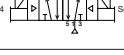
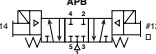
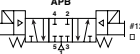
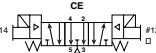
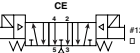
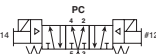
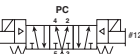





Valve with 3-Pin DIN Connectors - 5599-1, Non Plug-in, Size 3 (H3)

Symbol	Type	Cv	Operator	Voltage	Pilot	Non-locking	Locking		
3-Pin DIN Connector on Coil, 120 VDC									
	Sol. 14 	4-way, 2-position, spring return	6.0	Single solenoid	120 VAC	Internal	H3EWXBBL53D	H3EWXBCL53D	
						External	H3EWXXBL53D	H3EWXXCL53D	
	Sol. 14 	4-way, 2-position, air return	6.0	Single solenoid	120 VAC	Internal	H31WXBBL53D	H31WXBCL53D	
						External	H31WXXBL53D	H31WXXCL53D	
	Sol. 14 	4-way, 2-position	6.0	Double solenoid	120 VAC	Internal	H32WXBBL53D	H32WXBCL53D	
						External	H32WXXBL53D	H32WXXCL53D	
	#14 	APB 	4-way, 3-position, all ports blocked	5.0	Double solenoid	120 VAC	Internal	H35WXBBL53D	H35WXBCL53D
							External	H35WXXBL53D	H35WXXCL53D
	#14 	CE 	4-way, 3-position, center exhaust	5.0	Double solenoid	120 VAC	Internal	H36WXBBL53D	H36WXBCL53D
							External	H36WXXBL53D	H36WXXCL53D
#14 	PC 	4-way, 3-position, pressure center	5.0	Double solenoid	120 VAC	Internal	H37WXBBL53D	H37WXBCL53D	
						External	H37WXXBL53D	H37WXXCL53D	

Base / End Plate - 5599-1, Non Plug-in, Size 3 (H3) * Not compatible with H Universal

	Description	NPT	BSPP
	Single subbase Side ported base, 3/4" port	PS4211190CP	PS4211100CP
	End ported bases	PS4211590CP	PS4211500CP
	Bottom / end ported bases	PS4211690CP	PS4211600CP
Note: Manifolds include 2 pipe plugs			
	End plate - non-collective wiring	PS4231010DP	PS4231011DP

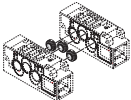
Accessories - 5599-1, Non Plug-in, Size 3 (H3)

Accessory	Description	Part number
	Common pressure	5-125 PSIG w/ gauge PS4237166CP
	Independent pressure	5-125 PSIG w/ gauge PS4237266CP
	Blanking plate kit	PS4234CP
	Sandwich flow control	PS4242CP
	Sandwich Flow Control and Common Port Sandwich Regulator may be sandwiched together on a manifold or subbase. The Sandwich Flow Control MUST be located between the manifold/subbase and the Common Port Sandwich Regulators. Do not use with Independent Port Sandwich Regulators.	
	Manifold to manifold gasket kits	PS4213P
	Manifold port isolation kit Main galley (1, 3, 5)	PS4232CP
	Manifold port isolation kit Pilot galley (12, 14)	PS4033CP

 Most popular.

D
Subbase & Manual Valves
H Series Micro
Modulflex Series
H Series ISO
Network Connectivity
DX ISOMAX Series
Valvair II Series



For inventory, lead times, and kit lookup, visit www.pdnplu.com

D116

Parker Hannifin Corporation
Pneumatic Division
Richland, Michigan
www.parker.com/pneumatics

Valve Central Connector - Non Plug-in, 5599-1, Size 3 (H3)

H3 **E** **WX** **B** **G** **2B9** **000F** **D**

Basic Series 5599-1
ISO 5599-1 Size 3 **H3**

5599-1 Operator / Function

Single solenoid, 2-position - air return	1
Double solenoid, 2-position	2
Double solenoid, 3-position - APB	5
Double solenoid, 3-position - CE	6
Double solenoid, 3-position - PC	7
Single solenoid, 2-position - air return, spring assist	E

5599-1 Mounting
Valve less base **WX**

5599-1 Pilot Source / Pilot Exhaust

Internal pilot, port #1 / vented	B
External pilot, port #12 or #14 / vented	X*

* Must be specified when using Sandwich Regulators.

5599-1 Overrides / Lights

Non-locking, flush, with light	G
Locking, flush, with light	H

5599-1 Engineering Level
D Current

5599-1 Central Connector Wiring Options

000C	Chrysler
000F*	SAE / Ford, ISO 20401
000G	General Motors

* Complies to ISO 20401 with Enclosure Lead Length "2".

Enclosure / Lead length / Voltage*

	AC		DC	
	60Hz	50Hz		
1B9†			24	3-pin, central mini connector, 3.2 watt
1F9†+			24	3-pin, central mini connector, 1.3 watt
123†	120	115		3-pin, central mini connector
2B9			24	4-pin, central M12 connector, 3.2 watt
2F9+			24	4-pin, central M12 connector, 1.3 watt
3B9			24	5-pin, central mini connector, 3.2 watt
3F9+			24	5-pin, central mini connector, 1.3 watt
323	120	115		5-pin, central mini connector
619‡			24	2-pin, M12 connector on coil

* All coils include LED & suppression
† Operator function "1" or "E"
‡ Only available with wiring option "000F"
+ Override "G" only.

Valve CNOMO - Non Plug-in, 5599-1 Size 3 (H3)

H3 **E** **WX** **B** **G** **L53** **D**

Basic Series 5599-1
ISO 5599-1 Size 3 **H3**

5599-1 Operator / Function

Single solenoid, 2-position - air return	1
Double solenoid, 2-position	2
Double solenoid, 3-position - APB	5
Double solenoid, 3-position - CE	6
Double solenoid, 3-position - PC	7
Single solenoid, 2-position - air return, spring assist	E

5599-1 Mounting
Valve less base **WX**

5599-1 Pilot Source / Pilot Exhaust

Internal pilot, port #1 / vented	B
External pilot, port #12 or #14 / vented	X*

* Must be specified when using Sandwich Regulators.

5599-1 Overrides / Lights

B	Non-locking, flush, push - no light
C	Locking, flush, push / turn - no light

5599-1 Engineering Level
D Current

Enclosure / Lead Length / Voltage

	AC		DC	
	60Hz	50Hz		
L42	24			3-pin, 30mm DIN 43650A with CNOMO connector
L45			12	3-pin, 30mm DIN 43650A with CNOMO connector
L49			24	3-pin, 30mm DIN 43650A with CNOMO connector
L53	120	115		3-pin, 30mm DIN 43650A with CNOMO connector
L57	240			3-pin, 30mm DIN 43650A with CNOMO connector
NXX				Valve less coil

 Most popular.



For inventory, lead times, and kit lookup, visit www.pdnplu.com

D117

Parker Hannifin Corporation
Pneumatic Division
Richland, Michigan
www.parker.com/pneumatics

D
Subbase & Manual Valves
H Series Micro
Modulflex Series
H Series ISO
Network Connectivity
DX ISOMAX Series
Valvair II Series

Remote Pilot - Size 3 (H3)

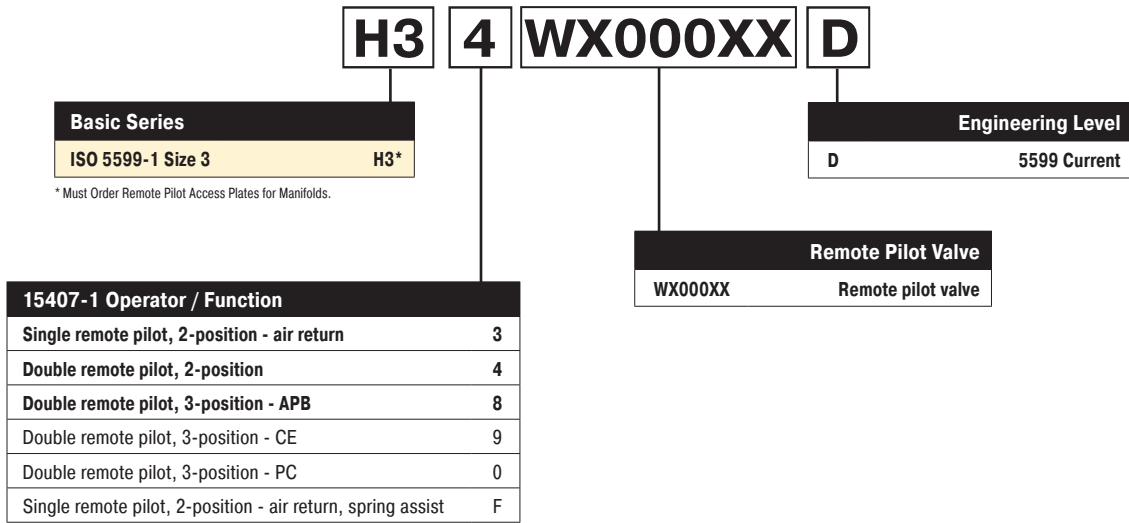

Note: For manifolds, end plates, and accessories, see 5599-1 Non Plug-in valve section.

Remote Pilot Access Plate Kits

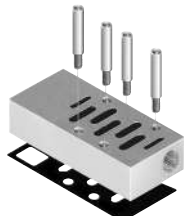

Size	Port Size	NPT	BSPP "G"
H3	1/8"	PS421500CP	PS421501CP

Kit includes: Pilot Port Access Plate, Gasket and Mounting Studs.

Most popular.



For inventory, lead times, and kit lookup, visit www.pdnplu.com

D118

Parker Hannifin Corporation
 Pneumatic Division
 Richland, Michigan
www.parker.com/pneumatics

D
 Subbase & Manual Valves
 H Series Micro
 Modulflex Series
 H Series ISO
 Network Connectivity
 DX ISOMAX Series
 Valvair II Series

Manifold / Subbase Kit - Non Plug-in, 5599-1, Size 3 (H3)

PS421159 **0** **C** **P**

Mounting Base Style / Port Size	
Subbase: 3/4 NPT side ports	PS421119
Subbase: 3/4 BSPP side port	PS421110*
Manifold: 3/4 NPT End port	PS421159
Manifold: 3/4 BSPP end port	PS421150*
Manifold: 3/4 NPT bottom / end port	PS421169
Manifold: 3/4 BSPP bottom / end port	PS421160*

* BSPP conforms to ISO 1179-1 w 228-1 threads.

Engineering Level	
C	H3

Enclosures / Lead Length	
0	None, No Electrical Plug - 5599-1



H3 Subbase shown



H3 Manifold shown

End Plate Kit - Non plug-in, 5599-1 * Not compatible with H Universal

PS423101 **0** **D** **P**

Basic Series	
ISO 5599, Size 3	PS423101

Thread Type	
0	NPT
1*	BSPP "G"

* BSPP conforms to ISO 1179-1 w 228-1 threads.

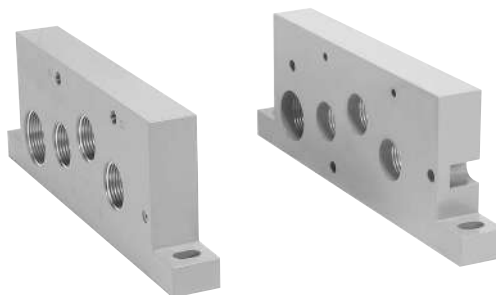

H3 Non-Collective Wiring End Plates

Most popular.



For inventory, lead times, and kit lookup, visit www.pdnplu.com

D119

Parker Hannifin Corporation
 Pneumatic Division
 Richland, Michigan
www.parker.com/pneumatics

D

Subbase & Manual Valves

H Series Micro

Moduflex Series

H Series ISO

Network Connectivity

DX ISOMAX Series

Valvair II Series

Add-A-Fold Assembly - Non Plug-in, 5599-1, Size 3 (H3) * Not compatible with H Universal

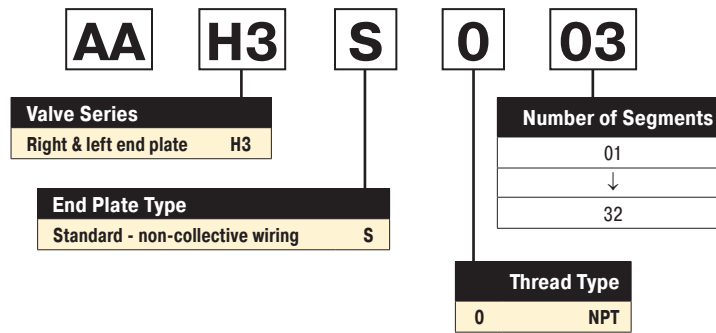

How To Order Non Plug-in Add-A-Fold Assemblies

- List Add-A-Fold Assembly call out. This automatically includes the end plate kit assembly.
- List complete valve, regulator, flow control and manifold base kit. List left to right, looking at the cylinder ports on the # 12 end of the manifold. The left most segment is segment 1. (If a blank station is needed, list the blanking plate part number and the individual manifold part numbers for the required segment.)

Example

Application requires a 3 segment manifold and regulator on segment 3.

Item	Part No.	Location	
01	AAH3S003		
02	H31WXBG2B9000FD	Segment 1	Valve station 1
03	PS4211590CP		Manifold base
04	H32WXBG2B9000FD	Segment 2	Valve station 2
05	PS4211590CP		Manifold base
06	H32WXXG2B9000FD	Segment 3	Valve station 3
07	PS4237166CP		Sandwich regulator
08	PS4211590CP		Manifold base

NOTE: Construct manifold assemblies from left to right while looking at the cylinder ports. Valves must be ordered as External Pilot when using Sandwich Regulator.

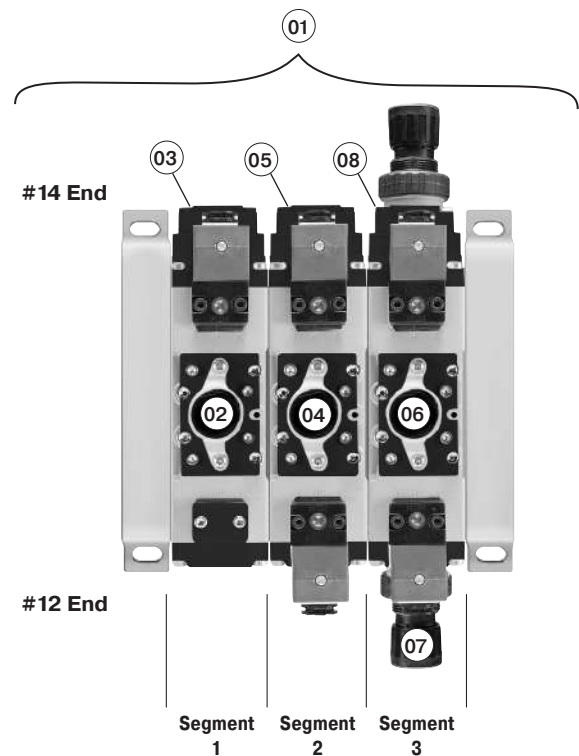

Example:
 3 segment manifold with (3) H3 valves on manifold bases and regulator at segment 3.

D
 Subbase & Manual Valves
 H Series Micro
 Modulflex Series
 H Series ISO
 Network Connectivity
 DX ISOMAX Series
 Valvair II Series

Most popular.



For inventory, lead times, and kit lookup, visit www.pdnplu.com

Sandwich Regulator - Non Plug-in, 5599-1, Size 3 (H3)

Basic Series	
H3 5599-1, Non Plug-in	PS4237

Regulator Function	
Common Pressure Regulator	1
Independent Pressure Regulator	2

#2 Port Regulator / Gauge*	
0**	Line By-Pass Plate
4	1-30 PSIG w/Gauge
5	2-60 PSIG w/Gauge
6	5-125 PSIG w/Gauge
D	Remote Pilot ISO 2 & 3 only

* For common pressure regulator option, regulator gauge callout must be the same number for both Port #4 and Port #2. (Example: 166)
 ** Pressure line by-pass option can only be used with independent pressure regulators.

#4 Port Regulator / Gauge*	
0**	Line By-Pass Plate
4	1-30 PSIG w/Gauge
5	2-60 PSIG w/Gauge
6	5-125 PSIG w/Gauge
D	Remote Pilot ISO 2 & 3 only

* For common pressure regulator option, regulator gauge callout must be the same number for both Port #4 and Port #2. (Example: 166)
 ** Pressure line by-pass option can only be used with independent pressure regulators.

Ordering Components

- Sandwich regulator kit configured for internal pilot as standard.
- Order valve as external pilot.

How to Configure Sandwich Regulator / Valve Combinations

Internal Pilot Configuration of Sandwich Regulator H3
 Pressure in Base Port 1 feeds regulator configured for Internal Pilot which feeds valve configured for External Pilot.

External Pilot Configuration of Sandwich Regulator H3
 An External Pilot pressure in Port 12 or 14 of the base feeds thru the Sandwich Regulator 12 or 14 galley directly to the 12/14 pilot of the valve. This configuration takes an External Pilot from the 12 port of the base and passes it thru the regulator to feed the 12 galley of the valve.

Note: Do not use Independent Port Sandwich Regulators with Sandwich Flow Controls.
 Independent Port Sandwich Port Regulators combine the #3 and #5 valve exhaust ports into the #5 exhaust at the manifold/subbase interface. The #3 port flow control will control both #3 and #5 exhaust. #5 port flow control is ineffective.

Sandwich Regulator Cv Flow Chart*

	Common Pressure Code 166				Single Pressure 2 Code 206				Single Pressure 4 Code 260				Dual Pressure Code 266			
	1-2	1-4	2-3	4-5	1-2	1-4	2-3	4-5*	1-2	1-4	2-3	4-5*	1-2	1-4	2-3	4-5*
H3	2.37	2.39	4.30	4.47	2.37	2.81	2.75	3.01	2.65	2.59	2.68	2.74	2.43	2.41	3.16	3.04

* Regulator Port exhaust through Base Port 3.
 Note: All Cv's calculated with regulator adjusted full open.

Most popular.



For inventory, lead times, and kit lookup, visit www.pdnplu.com

D121

Parker Hannifin Corporation
 Pneumatic Division
 Richland, Michigan
www.parker.com/pneumatics

D

Subbase & Manual Valves

H Series Micro

Modulflex Series

H Series ISO

Network Connectivity

DX ISOMAX Series

Valvair II Series

ISO Pneumatic Valve Standard Definitions

15407-1: Non-Plug-in Standards for Size 01 (26mm) & Size 02 (18mm) Wide Valves

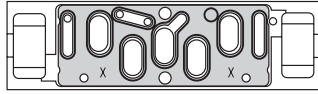

15407-2: Plug-in Standards for Size 01 (26mm) & Size 02 (18mm) Wide Valves

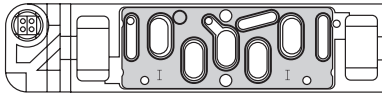

5599-1: Non-Plug-in Standards for Sizes 1, 2, 3

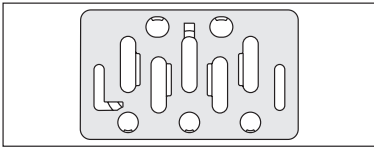

5599-2: Plug-in Standards for Size 1, 2, 3

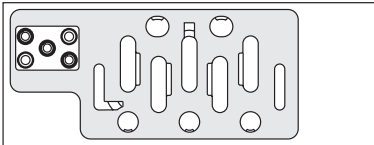

HB / HA Series

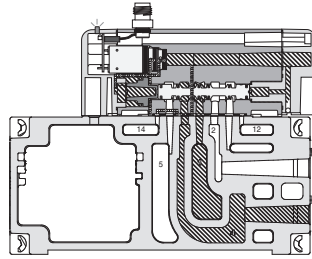

15407-1: 18mm Single Solenoid Internal Pilot Manifold Mounted

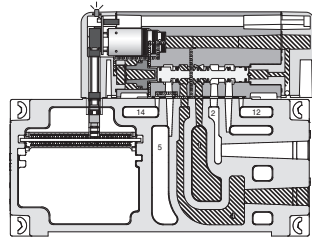

15407-2: 18mm Single Solenoid Internal Pilot Manifold Mounted

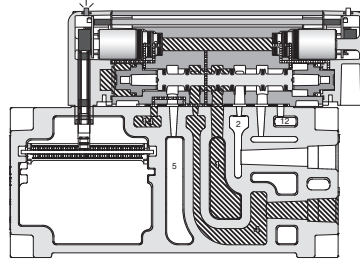

15407-2: 26mm Double Solenoid External Pilot Manifold Mounted

▨ Pressure □ Exhaust

H1, H2, H3 Series

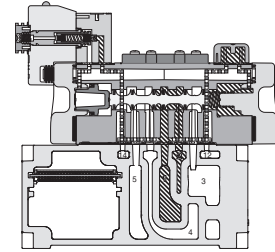

H1 5599-2: Single Solenoid Internal Pilot Manifold Mounted

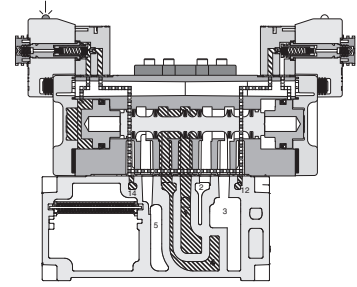

H2 5599-2: Double Solenoid External Pilot Manifold Mounted

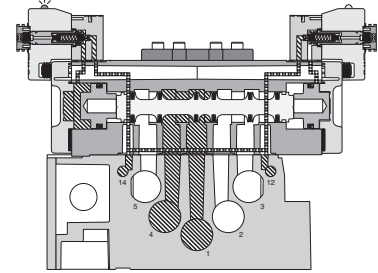

H3 5599-2: Double Solenoid External Pilot Subbase Mounted

▨ Pressure □ Exhaust

Wear Compensation System

- Maximum Performance
 - Low Friction
 - Lower Operating Pressures
 - Fast Response
 - Less Wear
- Long Cycle Life - Under pressure, radial expansion of the seal occurs to maintain sealing contact with the valve bore.
- Non-Lube Service - No lubrication required for continuous valve shifting.
- Bi-Directional Spool Seals - Common spool used for any pressure, including vacuum.

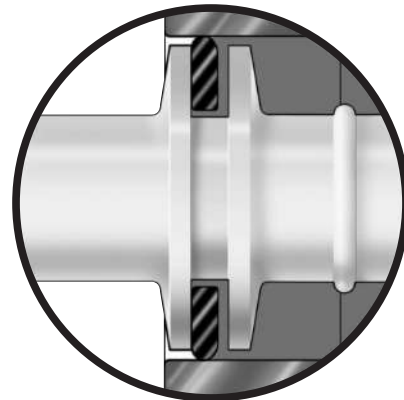

D	Subbase & Manual Valves
	H Series Micro
	Modurflex Series
	H Series ISO
	Network Connectivity
	DX ISOMAX Series
	Valvair II Series



For inventory, lead times, and kit lookup, visit www.pdnplu.com

Flow Rating (Cv)

Valve Size	Port Size	2-Position	3-Position
HB	1/8"	0.55 Cv, C = 1.5 NI/s x bar, b = 0.25, Qn = 390 l/min, Qmax = 648 l/min	0.50 Cv, C = 1.4 NI/s x bar, b = 0.25, Qn = 360 l/min, Qmax = 595 l/min
HA	1/4"	1.1 Cv, C = 3.6 NI/s x bar, b = 0.30, Qn = 918 l/min, Qmax = 1518 l/min	1.0 Cv, C = 3.3 NI/s x bar, b = 0.30, Qn = 845 l/min, Qmax = 1395 l/min
H1	3/8"	1.5 Cv, C = 5.0 NI/s x bar, b = 0.30, Qn = 1248 l/min, Qmax = 2070 l/min	1.2 Cv, C = 4.1 NI/s x bar, b = 0.30, Qn = 1000 l/min, Qmax = 1660 l/min
H2	1/2"	3.0 Cv, C = 9.7 NI/s x bar, b = 0.35, Qn = 2520 l/min, Qmax = 4140 l/min	2.8 Cv, C = 9.0 NI/s x bar, b = 0.35, Qn = 2340 l/min, Qmax = 3860 l/min
H3	3/4"	6.0 Cv, C = 18.7 NI/s x bar, b = 0.35, Qn = 5022 l/min, Qmax = 7848 l/min	5.0 Cv, C = 15.4 NI/s x bar, b = 0.35, Qn = 4185 l/min, Qmax = 6545 l/min

Cv tested per ANSI / (NFPA) T3.21.3 Flow tested According to ISO 6358.

Response Time (ms)**

Valve Size	Port Size	0 Cu. In. Chamber		# Cu. In. Chamber	
		Fill	Exhaust	Fill	Exhaust
Single Solenoid 2-Position - Air Return / Spring Assist					
HB	1/8"	28	30	141	154
HA	1/4"	24	26	77	124
H1	3/8"	28	39	124	198
H2	1/2"	38	76	149	295
H3	3/4"	56	70	163	235

F9, 1.3 W Coil Only

Single Solenoid 2-Position - Air Return / Spring Assist

Valve Size	Port Size	Fill	Exhaust	Fill	Exhaust
H1	3/8"	55	84	188	270
H2	1/2"	91	146	245	349
H3	3/4"	126	127	256	328

HB (12), HA (25), H1 (50), H2 (100), H3 (200)

** With 100 PSIG supply, time (ms) required to fill from 0 to 90 PSIG and Exhaust from 100 PSIG to 10 PSIG measured from the instant of energizing or de-energizing 24VDC solenoid.

Tested per ANSI / (NFPA) T3.21.8

Left End Plate Field Conversion

End plate kits and manifold assemblies are ordered as internal or single external pilot however field conversion is possible.

End Plate Configuration - Internal Pilot *

Insert 2 pipe plugs in locations A & B (1/8" NPT or G 1/8) as shown

Blocking off the pilot supply ports will configure the left end plate as internally piloted. Pilot pressure required to operate the H Series valves will be drawn from the supply or #1 port and no additional connections are required. Port locations C & D must be left unplugged for this option to function properly.

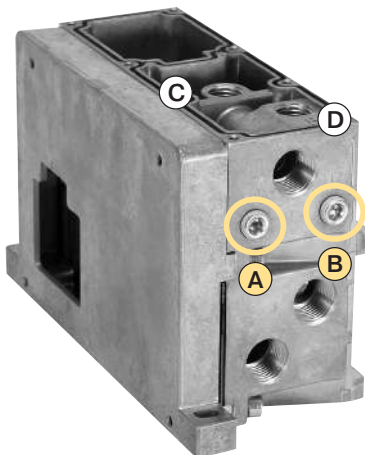

End Plate Configuration - Single External Pilot *

Insert 1 pipe plug into location C (1/4" NPT) as shown to configure the left end plate as single externally piloted.

Pilot pressure required to operate the H Series valves must be supplied to the 14 port only at location A which is internally connected to the 12 pilot.

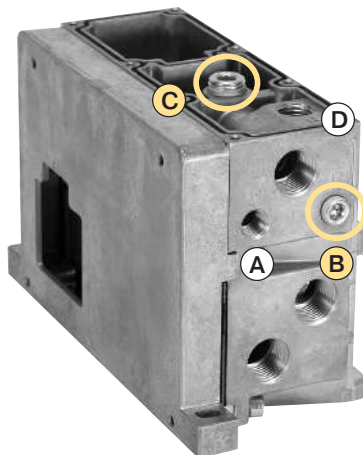

End Plate Configuration - Double External Pilot

Insert 2 pipe plugs in locations C & D (1/4" NPT) as shown to configure the left end plate as double externally piloted.

Pilot pressure required to operate the H Series valves must be supplied separately to both ports 14 and 12 (locations A and B).

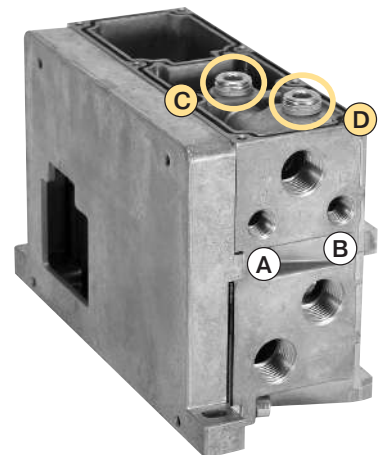

* Standard in catalog

Note: Left end plate shown with cover removed.



For inventory, lead times, and kit lookup, visit www.pdnplu.com

D123

Parker Hannifin Corporation
 Pneumatic Division
 Richland, Michigan
www.parker.com/pneumatics

D

Subbase & Manual Valves

H Series Micro

Modulflex Series

H Series ISO

Network Connectivity

DX ISOMAX Series

Valvair II Series

Common Port Regulation - Plug-in, HB & HA

Provides adjustable regulated air pressure to the valve's #1 port which gives the same pressure to both the #2 and #4 port of the manifold or subbase. The regulator is always on the 14 end of the valve.

HB Common Port Regulator Shown - Single Solenoid, 14 Energized

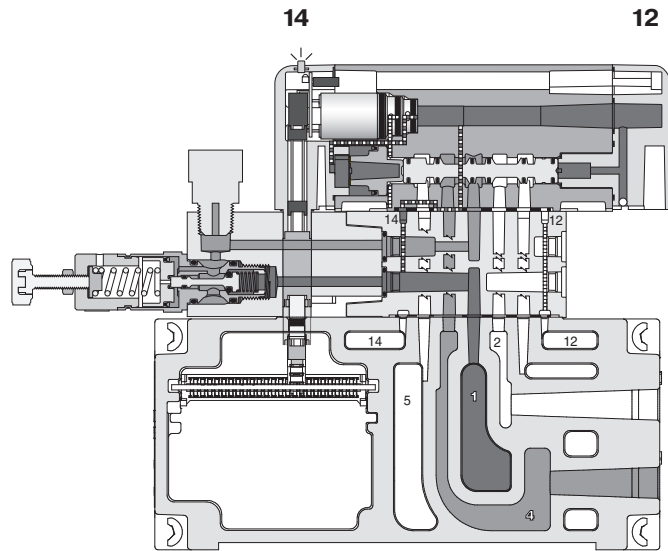
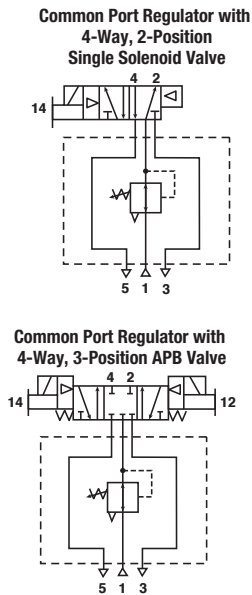

Independent Dual Port Regulation - Plug-in, HB & HA

Dual Port Regulator

Provides regulated pressure to both ports. Pressure regulation can occur out of the #2 or #4 port of the valve.

HB Independent Dual Port Regulator Shown - Double Solenoid, 14 Energized

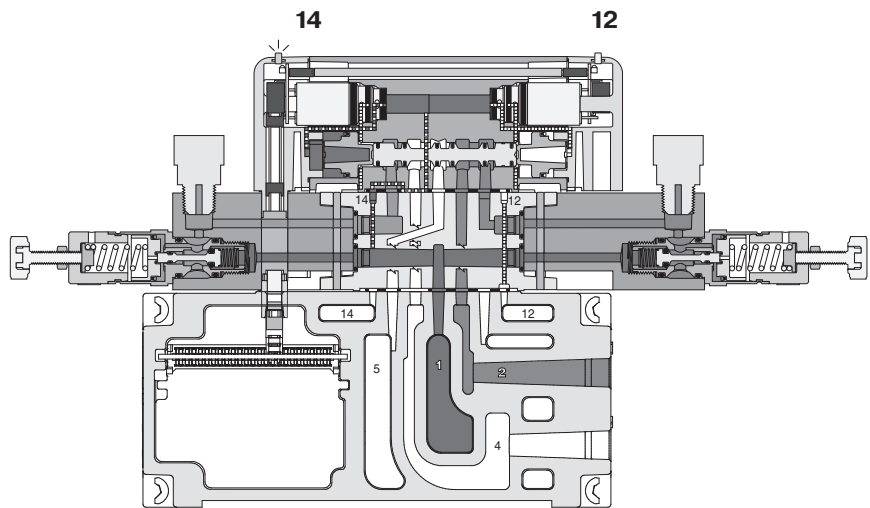
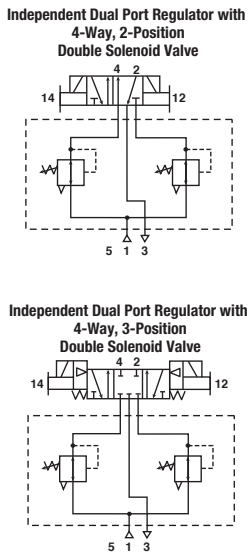

When using an Independent Pressure Sandwich Regulator, the cylinder outlet ports are reversed. The 12 end energizes the #4 port and the 14 end energizes the #2 port. The 3-Position CE and PC functions are also reversed. Do not use with Sandwich Flow Controls. Independent Port Sandwich Port Regulators combine the #3 and #5 valve exhaust ports into the #5 exhaust at the manifold/subbase interface. The #3 port flow control will control both #3 and #5 exhaust. #5 port flow control is ineffective. (See schematics above.)

D	Subbase & Manual
	Valves
H Series	Micro
Modulflex	Series
H Series	ISO
Network	Connectivity
DX ISOMAX	Series
Valvair II	Series



For inventory, lead times, and kit lookup, visit www.pdnplu.com

D124

Parker Hannifin Corporation
 Pneumatic Division
 Richland, Michigan
www.parker.com/pneumatics

Common Port Regulation - Non Plug-in, HB & HA

Provides adjustable regulated air pressure to the valve's #1 port which gives the same pressure to both the #2 and #4 port of the manifold or subbase. The regulator is always on the 14 end of the valve.

HB Common Port Regulator Shown - Single Solenoid, 14 Energized

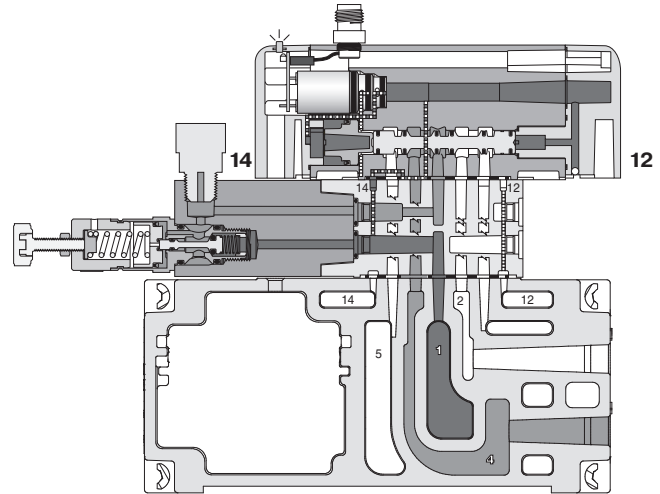
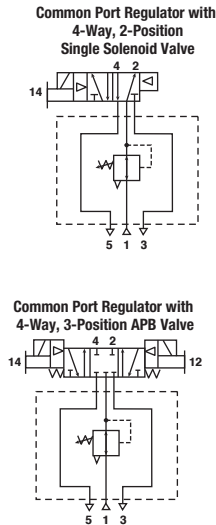

Independent Dual Port Regulation - Non Plug-in, HB & HA

Dual Port Regulator

Provides regulated pressure to both ports. Pressure regulation can occur out of the #2 or #4 port of the valve.

HB Independent Dual Port Regulator Shown - Double Solenoid, 14 Energized

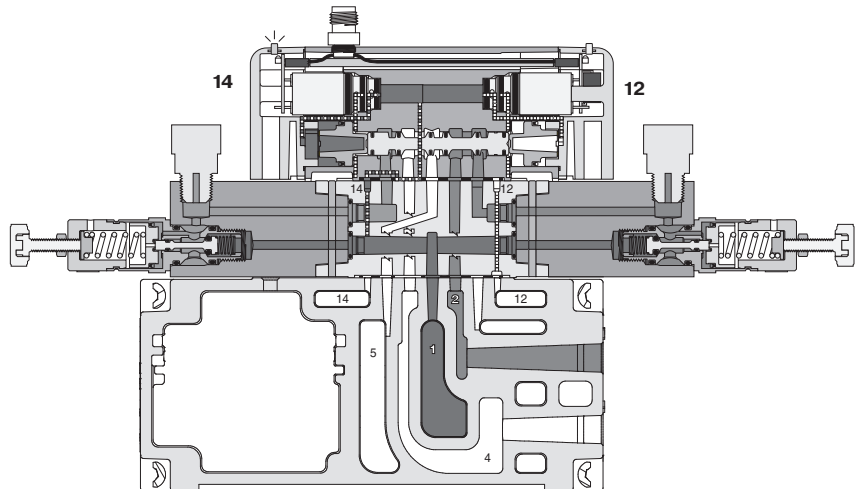
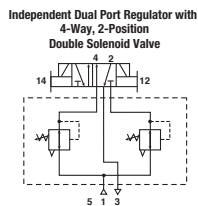

When using an Independent Pressure Sandwich Regulator, the cylinder outlet ports are reversed. The 12 end energizes the #4 port and the 14 end energizes the #2 port. The 3-Position CE and PC functions are also reversed. Do not use with Sandwich Flow Controls. Independent Port Sandwich Port Regulators combine the #3 and #5 valve exhaust ports into the #5 exhaust at the manifold/subbase interface. The #3 port flow control will control both #3 and #5 exhaust. #5 port flow control is ineffective. (See schematics on above.)

Most popular.



For inventory, lead times, and kit lookup, visit www.pdnplu.com

D125

Parker Hannifin Corporation
 Pneumatic Division
 Richland, Michigan
www.parker.com/pneumatics

D	Subbase & Manual Valves
	H Series Micro
	Moduflex Series
	H Series ISO
Network Connectivity	
DX ISOMAX Series	
Valvair II Series	

Common Port Regulation - Plug-in, H1, H2, H3

Provides adjustable regulated air pressure to the valve's #1 port which gives the same regulated pressure to both the #2 and #4 port of the manifold or subbase. The regulator is always on the 14 end of the valve.

H2 Common Port Regulator Shown - Double Solenoid, 14 Energized, Internal Pilot

Common Port Regulator with 4-Way, 2-Position Single Solenoid Valve

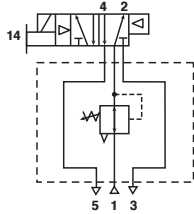

Common Port Regulator with 4-Way, 3-Position APB Valve

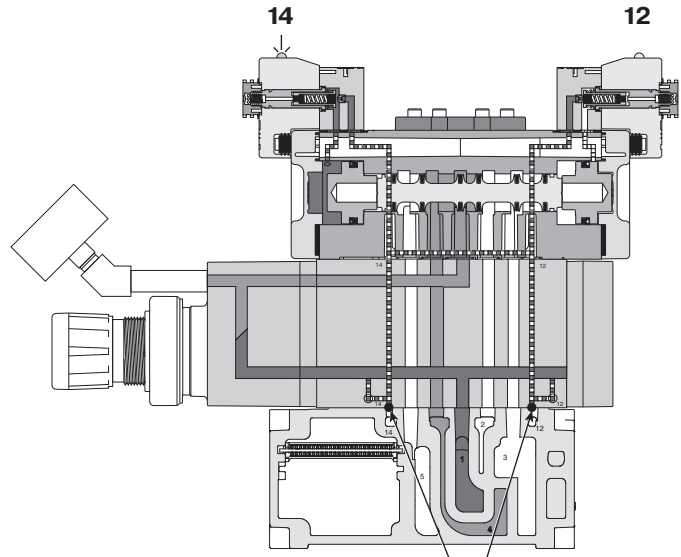
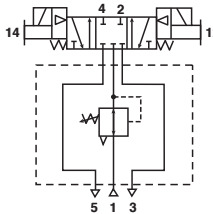

Sandwich Regulator has standard configuration of internal Pilot with the Pilot Plug in the bottom of the I & E Pilot Holes which prevents line pressure from escaping through the manifold.

Independent Port Regulation - Plug-in, H1, H2, H3

Single Port Regulator

Provides regulated pressure to one of the ports and full line pressure to the other by use of the Line Pressure By-Pass Plate. Pressure regulation can occur out of the #4 port of the valve.

H1 Independent Port Regulator Shown - Double Solenoid, De-energized, Internal Pilot

Independent Port Regulator with 4-Way, 3-Position All Ports Blocked Valve

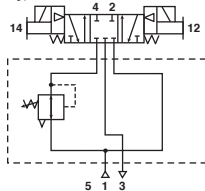

Independent Port Regulator with 4-Way, 3-Position, Inlet to Cylinder Function

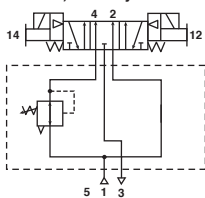

Independent Port Regulator with 4-Way, 3-Position, Cylinder to Exhaust Function

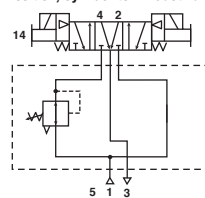

⚠ CAUTION: Requires 4-Way, 3-Position, Cylinder to Exhaust Valve

⚠ CAUTION: Requires 4-Way, 3-Position, Inlet to Cylinder Valve

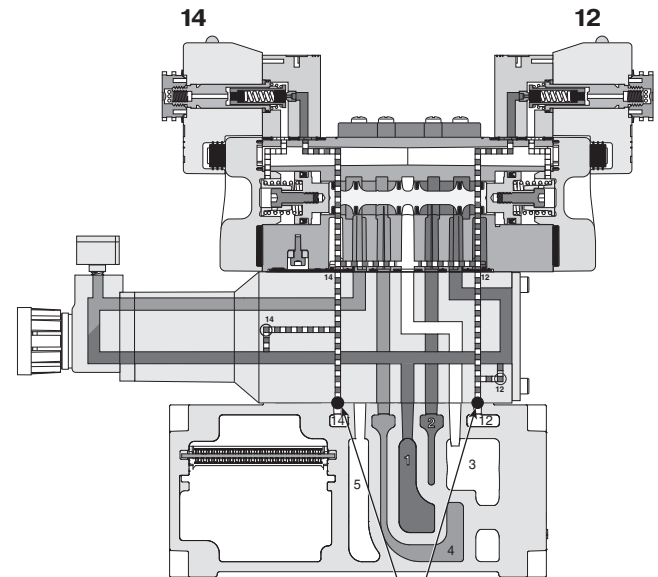

Sandwich Regulator has standard configuration of internal Pilot with the Pilot Plug in the bottom #12 and #14 Pilot Hole which prevents line pressure from escaping through the manifold.

When using an Independent Pressure Sandwich Regulator, the cylinder outlet ports are reversed. The 12 end energizes the #4 port and the 14 end energizes the #2 port. The 3-Position CE and PC functions are also reversed. Do not use with Sandwich Flow Controls. Independent Port Sandwich Port Regulators combine the #3 and #5 valve exhaust ports into the #5 exhaust at the manifold/subbase interface. The #3 port flow control will control both #3 and #5 exhaust. #5 port flow control is ineffective. (See schematics above.)

D	Subbase & Manual Valves
H Series Micro	
Modulflex Series	
H Series ISO	
Network Connectivity	
DX ISOMAX Series	
Valvair II Series	



For inventory, lead times, and kit lookup, visit www.pdnplu.com

Independent Dual Port Regulation - Plug-in, H1, H2, H3

Dual Port Regulator

Provides regulated pressure to both ports. Pressure regulation can occur out of the #2 or #4 port of the valve.

H1 Independent Dual Port Regulator Shown - Double Solenoid, 14 Energized, Internal Pilot

Independent Dual Port Regulator with 4-Way, 2-Position Double Solenoid Valve

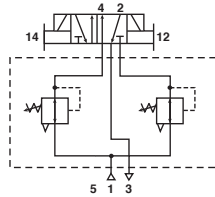

Independent Dual Port Regulator with 4-Way, 3-Position Double Solenoid Valve

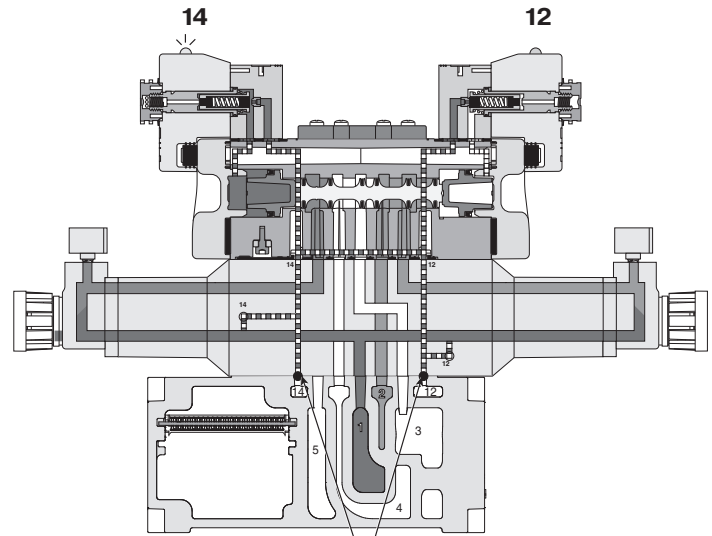
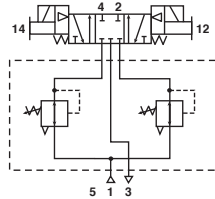

Sandwich Regulator has standard configuration of Internal Pilot with the Pilot Plug in the bottom #12 and #14 Pilot Hole which prevents line pressure from escaping through the manifold.

When using an Independent Pressure Sandwich Regulator, the cylinder outlet ports are reversed. The 12 end energizes the #4 port and the 14 end energizes the #2 port. The 3-Position CE and PC functions are also reversed. Do not use with Sandwich Flow Controls. Independent Port Sandwich Port Regulators combine the #3 and #5 valve exhaust ports into the #5 exhaust at the manifold/subbase interface. The #3 port flow control will control both #3 and #5 exhaust. #5 port flow control is ineffective. (See schematics on above.)

D

Subbase & Manual Valves

H Series Micro

Modulflex Series

H Series ISO

Network Connectivity

DX ISOMAX Series

Valvair II Series



For inventory, lead times, and kit lookup, visit www.pdnplu.com

D127

Parker Hannifin Corporation
 Pneumatic Division
 Richland, Michigan
www.parker.com/pneumatics

Common Port Regulation - Non Plug-in, H1, H2, H3

Provides adjustable regulated air pressure to the valve's #1 port which gives the same regulated pressure to both the #2 and #4 port of the manifold or subbase. The regulator is always on the 14 end of the valve.

H2 Common Port Regulator Shown - Double Solenoid, 14 Energized, Internal Pilot

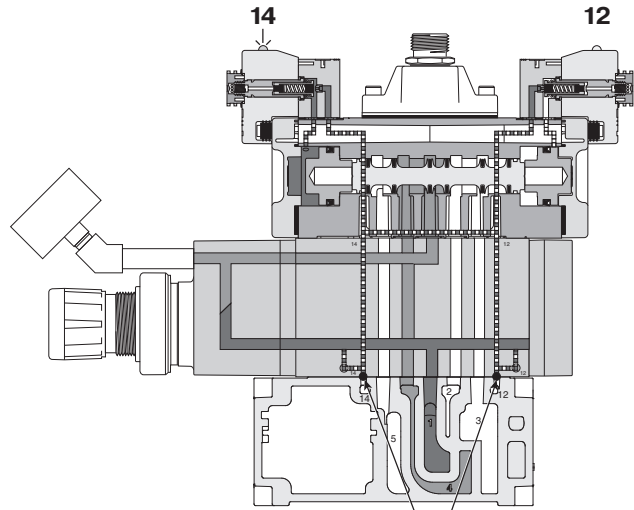
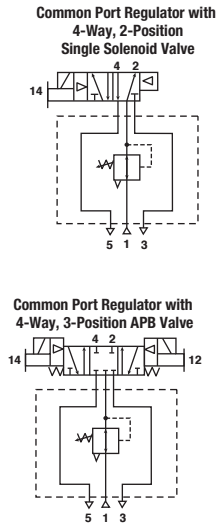

Sandwich Regulator has standard configuration of Internal Pilot with the Pilot Plug in the bottom of the I & E Pilot Holes which prevents line pressure from escaping through the manifold.

Independent Port Regulation - Non Plug-in, H1, H2, H3

Single Port Regulator

Provides regulated pressure to one of the ports and full line pressure to the other by use of the Line Pressure By-Pass Plate. Pressure regulation can occur out of the #4 port of the valve.

H1 Independent Port Regulator Shown - Double Solenoid, De-energized, Internal Pilot

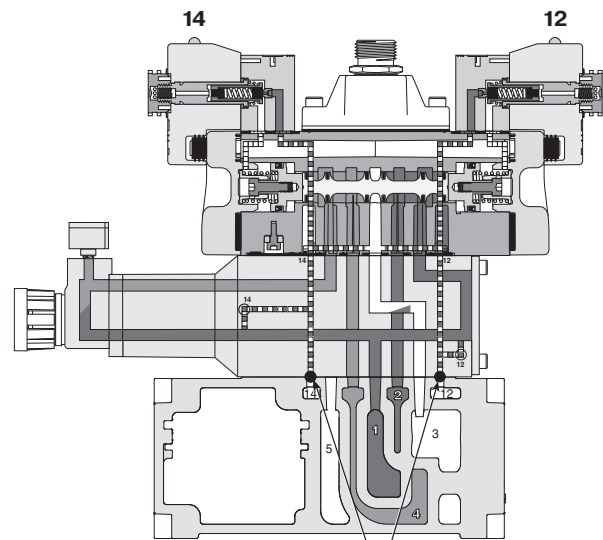
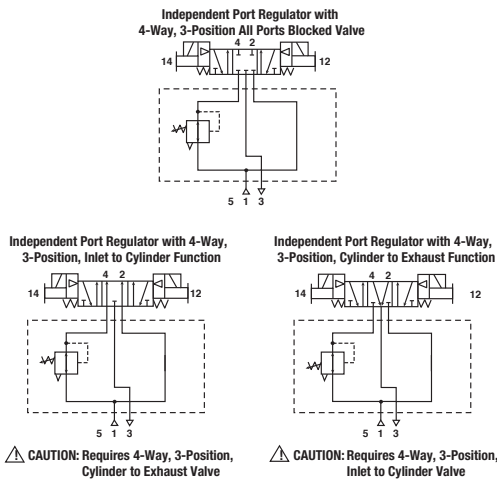

Sandwich Regulator has standard configuration of Internal Pilot with the Pilot Plug in the bottom #12 and #14 Pilot Hole which prevents line pressure from escaping through the manifold.

When using an Independent Pressure Sandwich Regulator, the cylinder outlet ports are reversed. The 12 end energizes the #4 port and the 14 end energizes the #2 port. The 3-Position CE and PC functions are also reversed. Do not use with Sandwich Flow Controls. Independent Port Sandwich Port Regulators combine the #3 and #5 valve exhaust ports into the #5 exhaust at the manifold/subbase interface. The #3 port flow control will control both #3 and #5 exhaust. #5 port flow control is ineffective. (See schematics on above.)

D	Subbase & Manual Valves
	H Series Micro
D	Modulflex Series
	H Series ISO
D	Network Connectivity
	DX ISOMAX Series
D	Valvair II Series



For inventory, lead times, and kit lookup, visit www.pdnplu.com

Independent Dual Port Regulation - Non Plug-in, H1, H2, H3

Dual Port Regulator

Provides regulated pressure to both ports. Pressure regulation can occur out of the #2 or #4 port of the valve.

H1 Independent Dual Port Regulator Shown - Double Solenoid, 14 Energized, Internal Pilot

Independent Dual Port Regulator with 4-Way, 2-Position Double Solenoid Valve

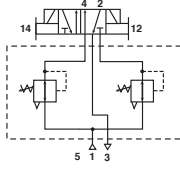

Independent Dual Port Regulator with 4-Way, 3-Position Double Solenoid Valve

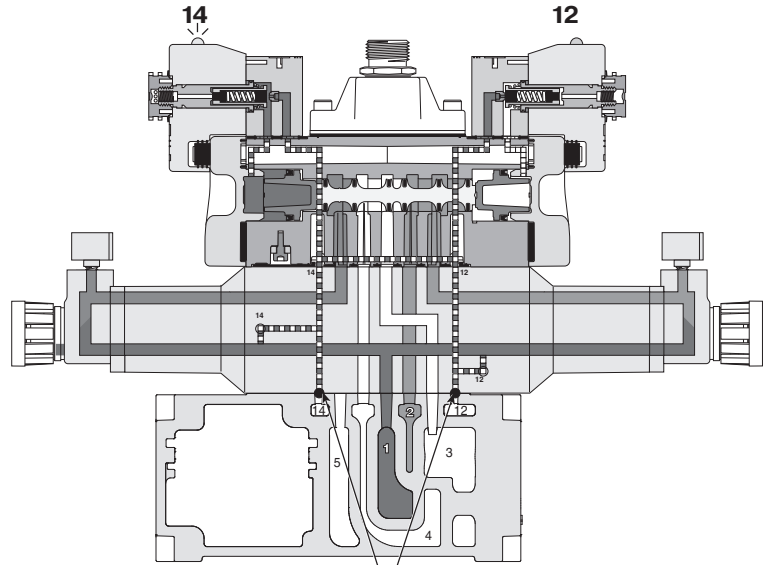
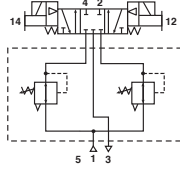

Sandwich Regulator has standard configuration of Internal Pilot with the Pilot Plug in the bottom #12 and #14 Pilot Hole which prevents line pressure from escaping through the manifold.

When using an Independent Pressure Sandwich Regulator, the cylinder outlet ports are reversed. The 12 end energizes the #4 port and the 14 end energizes the #2 port. The 3-Position CE and PC functions are also reversed. Do not use with Sandwich Flow Controls. Independent Port Sandwich Port Regulators combine the #3 and #5 valve exhaust ports into the #5 exhaust at the manifold/subbase interface. The #3 port flow control will control both #3 and #5 exhaust. #5 port flow control is ineffective. (See schematics on above.)

D	Subbase & Manual Valves
H Series Micro	Modulflex Series
H Series ISO	Network Connectivity
DX ISOMAX Series	Valvair II Series



For inventory, lead times, and kit lookup, visit www.pdnplu.com

D129

Parker Hannifin Corporation
 Pneumatic Division
 Richland, Michigan
www.parker.com/pneumatics

Minimum Operating Voltage

	HB	HA	H1	H2	H3
MOV (24VDC)	20.4	20.4	20.4	20.4	20.4
MOV (120VAC)	102*	102*	102	102	102

* 120VAC coils have a dropout voltage of 10VAC when used with solid state relays. A pull-down resistor may be necessary.

P2H IO-Link

Class B, M12 pin

Pin Number	Address
1	L+
2	AUX+
3	L-
4	C/Q
5	AUX-

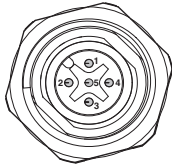

Class A, M12 pin

Pin Number	Address
1	L+
2	L-
3	L-
4	C/Q
5	L-

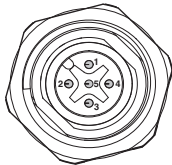

Class A, Power IN / OUT 7/8 pin

Class A, 5-Pin

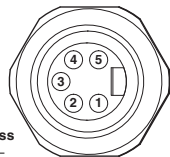

Pin Number	Address
1	AUX-
2	*L-
3	Earth
4	*L+
5	AUX+

Class A, 4-Pin

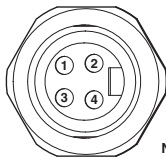

Pin Number	Address
1	AUX+
2	*L+
3	*L-
4	AUX-

*7/8" logic power has no connection to internal P2H unit but does carryover to OUT 7/8" connector (for jumper logic power only). Logic power for P2H unit will be supplied from M12 (pin 1 & 3).

19-Pin Connector, Round Brad Harrison

Male, face view

Pin Number	Address
1	0
2	1
3	2
4	3
5	N/A
6	4
7	Common
8	5
9	6
10	7

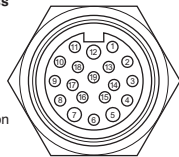

Pin Number	Address
11	8
12	Ground
13	9
14	10
15	11
16	12
17	13
18	14
19	15

19-Pin Round Cable Specifications

Common Pin "7" is rated for 8 amps. Cable common wire must be greater than total amperage of solenoids on Add-A-Fold assembly.

Example: 8 segment manifold, 16 solenoids, 120VAC - 16 x .039 amps = .63 total amp rating.

NEMA 4 rated with properly assembled NEMA 4 rated cable.

M23, Round Connector

Male 12-pin connector, face view

Pin Number	Address
1	0
2	1
3	2
4	3
5	4
6	5

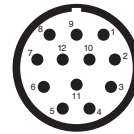

Pin Number	Address
7	6
8	7
9	Ret (Common)
10	Ret (Common)
11	Not Used
12	Ground

Male 19-pin connector, view into end plate

Pin Number	Address
1	0
2	1
3	2
4	3
5	4
6	Common
7	5
8	6
9	7

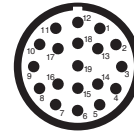

Pin Number	Address
10	8
11	9
12	Not Used
13	10
14	11
15	12
16	13
17	14
18	15
19	Not Used

25-Pin, D-Sub Connector

Male, view into end plate connector

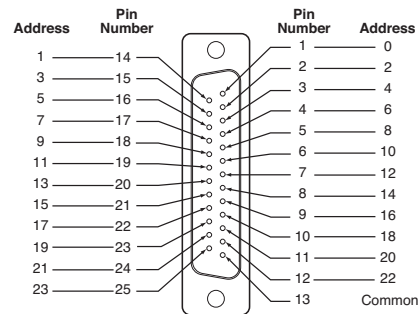

Female, view into cable connector

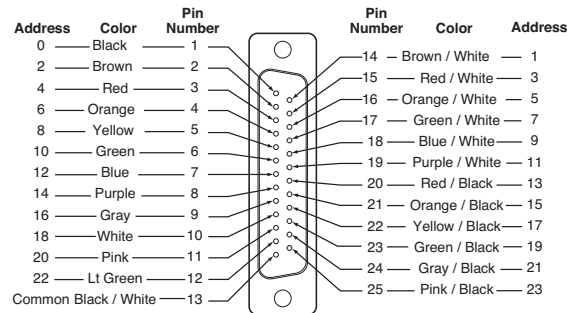

Description	Length	Part Number
25-pin, D-sub cable, IP20	3 Meters	P8LMH25M3A
25-pin, D-sub cable, IP20	9 Meters	SCD259D
25-pin, D-sub cable, IP65	3 Meters	SCD253W
25-pin, D-sub cable, IP65	9 Meters	SCD259WE



D
 Subbase & Manual Valves
 H Series Micro
 Modulflex Series
 H Series ISO
 Network Connectivity
 DX ISOMAX Series
 Valvaire II Series



For inventory, lead times, and kit lookup, visit www.pdnplu.com

Subbase Wiring

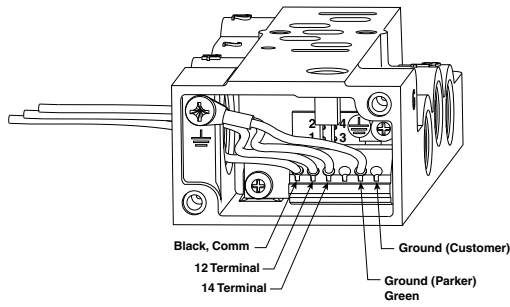

All commons internally connected on terminal strip

Connections	14 Solenoid	12 Solenoid
Valves with Wires	Black Wires	Red Wires
Valves with Terminal Block (Will accept 18 to 24 Gauge Wires)	14 and Com Terminals	12 and Com Terminals

Manifold Wiring - Size 3

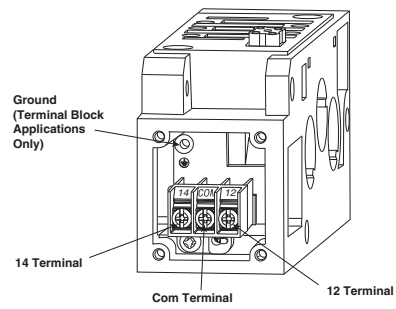

Terminal Box Wiring (H Universal)

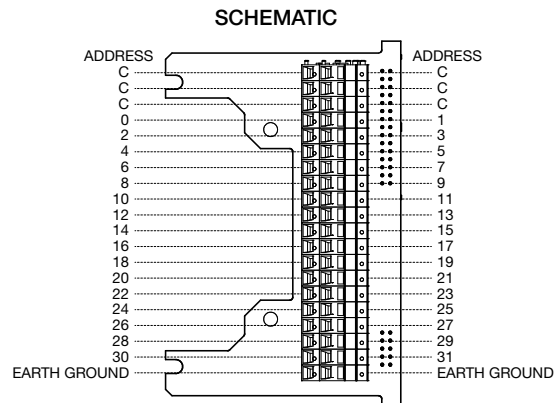
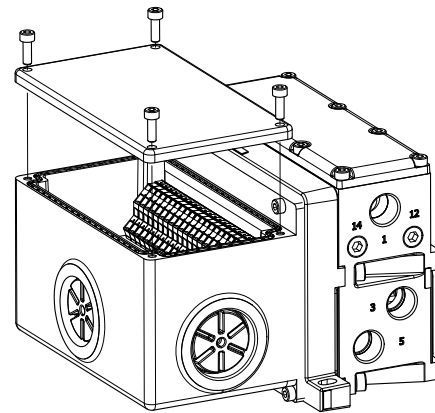
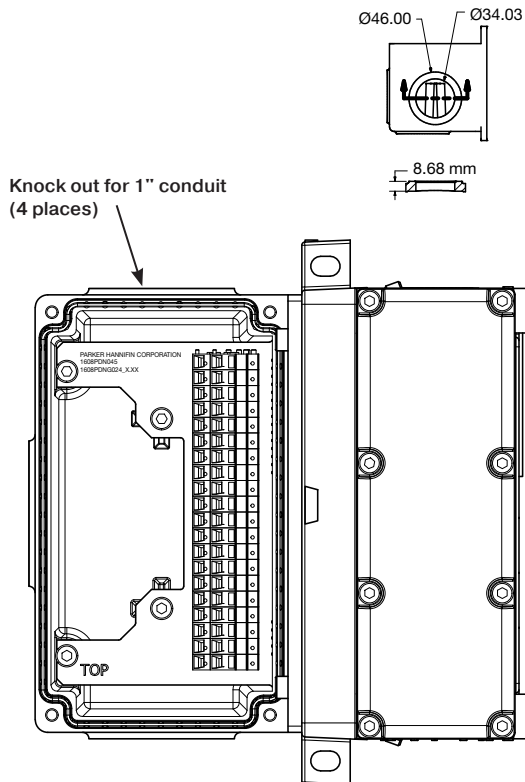

All commons internally connected on terminal strip

D

Subbase & Manual Valves

H Series Micro

Moduflex Series

H Series ISO

Network Connectivity

DX ISOMAX Series

Valvair II Series



For inventory, lead times, and kit lookup, visit www.pdnplu.com

D131

Parker Hannifin Corporation
 Pneumatic Division
 Richland, Michigan
www.parker.com/pneumatics

Electrical Connectors - Size 1, 2 & 3

5599-1 CNOMO

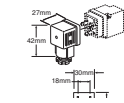

30mm 3-Pin ISO 4400
(DIN 43650A)

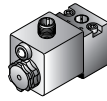

2-Pin M12 Euro

5599-2

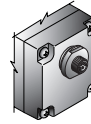

Manifold Auto Connector
(H3 Only)

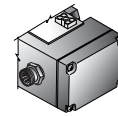

Subbase Auto Connector

5599-1 AUTO

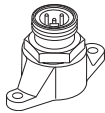

3-Pin Mini

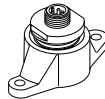

4-Pin Micro

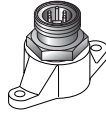

5-Pin Mini

30mm Square 3-Pin – ISO 4400, DIN 43650A (Use with Enclosure “A”)

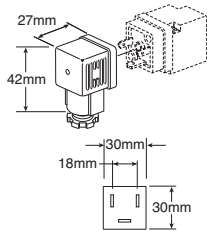

Description	Connector with 6' (2m) Cord	Connector
Unlighted	PS2028JCP	PS2028BP
Light – 6-48V. 50/60Hz. 6-48VDC	PS2032J79CP*	PS203279BP
Light – 120V/60Hz	PS2032J83CP*	PS203283BP

* LED with surge suppression.

Note: Max ø6.5mm cable size required for connector w/o 6' (2m) cord. IP65 rated when properly installed.

Engineering data: Conductors: 2 poles plus ground; cable range (connector only): 8 to 10mm (0.31 To 0.39 Inch); contact spacing: 18mm

D
 Subbase & Manual Valves
 H Series Micro
 Modulflex Series
 H Series ISO
 Network Connectivity
 DX ISOMAX Series
 Valvair II Series

7/8" Mini Power Cables - use with 5-pin mini connector

Description	Part Number
RKM Female Socket 4-pin female to flying lead cable, 5 meters, TPE	RKM 46-5M/S1587
RKM Female Socket 5-pin female to flying lead cable, 5 meters, TPE	RKM 56-5M/S1587
RSM Male Pins 4-pin male to female cable, TPE	RSM RKM 46-x/S1587
RSM Male Pins 5-pin male to female cable, TPE	RSM RKM 56-x/S1587
WKM Female Socket 4-pin right angle female to flying lead cable, 5 meters, TPE	WKM 46-5M/S1587
WKM Female Socket 5-pin right angle female to flying lead cable, TPE	WKM 56-5M/S1587

Where x = 2, 4, 5, 6, 8, 10 meter standard lengths

M12 A-code Cables - use with 4-pin micro, 2-pin micro

Description	Part Number
RKC Female Sockets 4-pin female to flying lead cable, PVC	RKC 4.4T-1
RKC Female Sockets 4-pin male to flying lead cable, PVC	RSC 4.4T-*
RKC Female Sockets 4-pin male to female cable, PVC	RKC 4.4T-*/RSC 4.4T
RKC Female Sockets 5-pin female to flying lead cable, TPE	RKC 4.5T-*/S1587
RKC Female Sockets 5-pin male to flying lead cable, TPE	RSC 4.5T-4/S1587
RKC Female Sockets 5-pin male to female cable, TPE	RKC 4.5T-*/RSC 4.5T/S1587

Where * = 1, 2, 3, 4 meter standard lengths



For inventory, lead times, and kit lookup, visit www.pdnplu.com

Automotive Connection – Wiring Options

‘C’ Chrysler Connection

5-Pin Male / Single Solenoid
 (Encl. Option 3, Auto Option C)

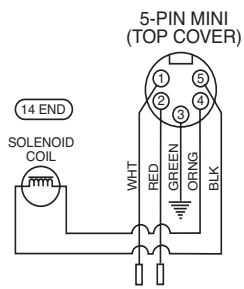

5-Pin Male / Double Solenoid
 (Encl. Option 3, Auto Option C)

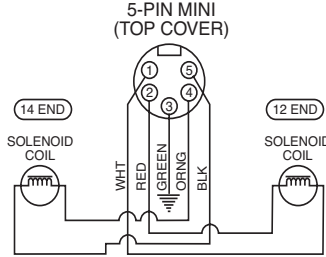

4-Pin Male / Single Solenoid
 (Encl. Option 2, Auto Option C)

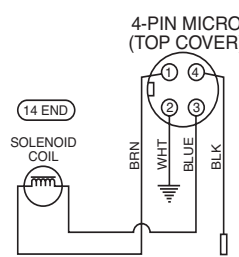

4-Pin Male / Double Solenoid
 (Encl. Option 2, Auto Option C)

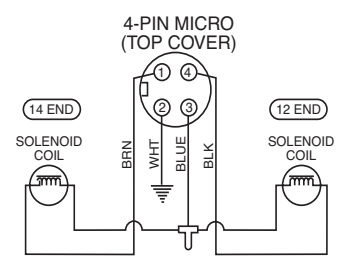

‘F’ SAE / Ford Wiring

5-Pin Male / Single Solenoid
 (Encl. Option 3, Auto Option F)

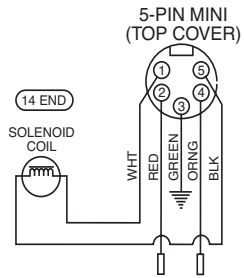

5-Pin Male / Double Solenoid
 (Encl. Option 3, Auto Option F)

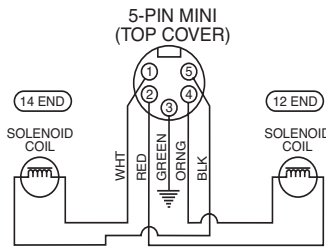

ISO 20401
4-Pin Male / Single Solenoid
 (Encl. Option 2, Auto Option F)

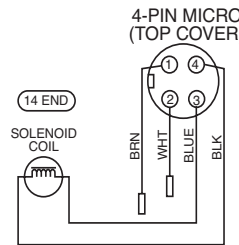

ISO 20401
4-Pin Male / Double Solenoid
 (Encl. Option 2, Auto Option F)

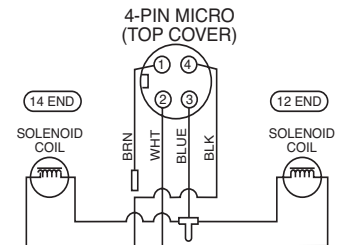

‘G’ GM Wiring

5-Pin Male / Single Solenoid
 (Encl. Option 3, Auto Option G)

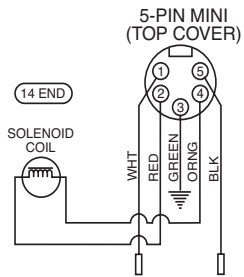

5-Pin Male / Double Solenoid
 (Encl. Option 3, Auto Option G)

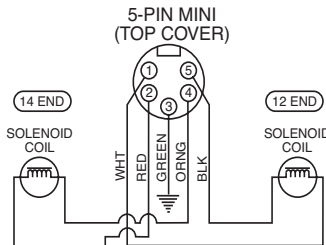

4-Pin Male / Single Solenoid
 (Encl. Option 2, Auto Option G)

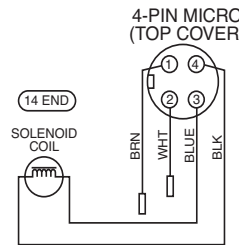

4-Pin Male / Double Solenoid
 (Encl. Option 2, Auto Option G)

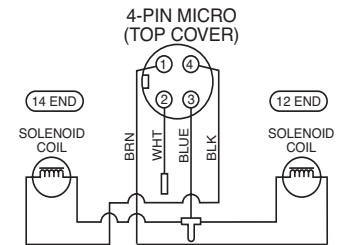

CNOMO Connection - Wiring Options

2-Pin Male / Single Solenoid
 (Encl. Option 6, Auto Option F)

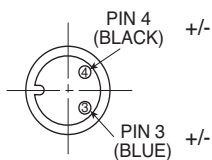

3-Pin Male / Single Solenoid
 (Encl. Option 1, Auto Options C, F & G)

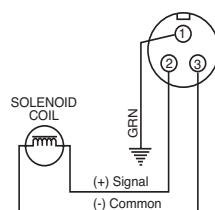

**Maximum Number of Solenoids
(Maximum energized simultaneously)**

	Voltage Code	25-pin D-sub	19-pin Brad Harrison	12-Pin M23	19-pin M23	P2H IO-Link Node	P2H Ethernet Node	PCH Portal	Turck Network Portal	
									16 Outputs	32 Outputs
HA & HB										
24VDC	G9 (1.0 watt)	24 (24)	16 (16)	8 (8)	16 (16)	24 (24)	32 (32)	32 (32)	16 (16)	32 (32)
120VAC*	23 (1.0 VA)	24 (24)	16 (16)	8 (8)	16 (16)	N/A	N/A	N/A	N/A	N/A
H1, H2										
12VDC	45 (2.4 watt)	24 (13)	16 (13)	8 (8)	16 (13)	N/A	N/A	N/A	N/A	N/A
24VAC*	42 (4.0 VA)	24 (24)	16 (16)	8 (8)	16 (16)	N/A	N/A	N/A	N/A	N/A
24VDC	B9 (3.2 watt)	24 (24)	16 (16)	8 (8)	16 (16)	24 (24)†	32 (32)	32 (32)	16 (16)	32 (32)
24VDC	F9 (1.3 watt)	24 (24)	16 (16)	8 (8)	16 (16)	24 (24)†	32 (32)	32 (32)	16 (16)	32 (32)
120VAC*	23 (4.5 VA)	24 (24)	16 (16)	8 (8)	16 (16)	N/A	N/A	N/A	N/A	N/A
H3 Only										
12VDC	45 (2.4 watt)	24 (13)	16 (13)	8 (8)	16 (13)	N/A	N/A	N/A	N/A	N/A
24VAC*	42 (4.0 VA)	24 (24)	16 (16)	8 (8)	16 (16)	N/A	N/A	N/A	N/A	N/A
24VDC	B9 (3.2 watt)	24 (20)	16 (16)	8 (8)	16 (16)	24 (24)†	32 (32)**	N/A	16 (16)	24 (21)
24VDC	F9 (1.3 watt)	24 (24)	16 (16)	8 (8)	16 (16)	24 (24)†	32 (32)**	N/A	16 (16)	24 (24)
120VAC*	23 (4.5 VA)	24 (24)	16 (16)	8 (8)	16 (16)	N/A	N/A	N/A	N/A	N/A

* Not CSA certified for 25-pin, D-sub option.

** Must use H Universal manifold end plate kit with transition kit to H3 manifold segments.

† Use Type A IO-Link module for 24 outputs simultaneously.

D
 Subbase & Manual Valves
 H Series Micro
 Modflex Series
 H Series ISO
 Network Connectivity
 DX ISOMAX Series
 Valvair II Series

I/O Addressing Examples

HB, HA, H1, H2 - Five Segment Manifold Example

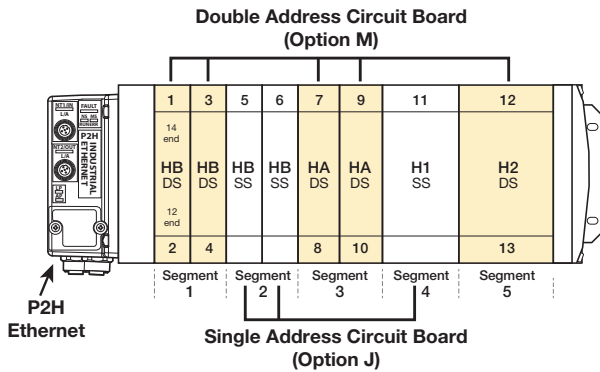

HB, HA, H1, H2 - Nine Segment Manifold with Intermediate Supply Example

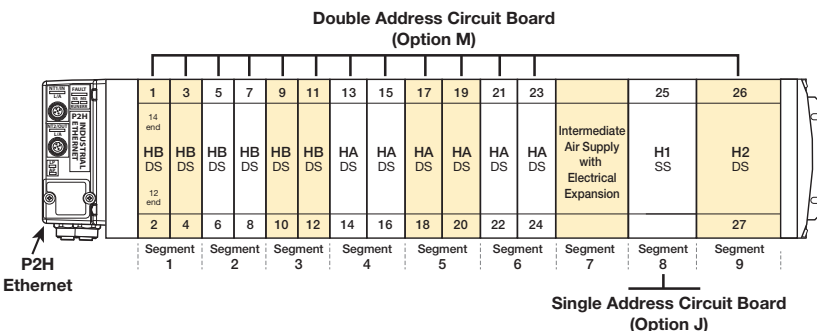

Notes: SS = Single Solenoid Valve
DS = Double Solenoid Valve
First output address is the #14 end of the valve closest to the valve driver module.

Intermediate Module with Electrical Expansion to 25th address required for manifolds with greater than 24 solenoid addresses.



For inventory, lead times, and kit lookup, visit www.pdnplu.com

Accessories

5599-2 & 5599-1 AUTO Solenoid Kits

Valve Size	Voltage Code	Coil Kit Number
H1, H2 & H3	42 (24VAC)	PS404142P
	45 (12VDC)	PS404145P
	B9 (24VDC), 3.2 watt	PS4041B9P
	F9 (24VDC), 1.3 watt	PS4041F9P
	23 (120VAC)	PS404123P
	57 (240VAC)	PS404157P

Quantity 1

Pilot Operator - CNOMO

Valve Size		Kit Number
H1, H2 & H3	Locking	PS4052CP
	Non-locking	PS4053CP
	Non-locking †	PS4054CP

† F9 (1.3 watt) coil option only.

Manifold Hardware Kits

Valve Size	Kit Number
HB, HA, H1, H2 *	PSHU10P
H3 **	PS4212P

* Quantity 20

** Quantity 12

Valve Bolt Kits

Valve Size	Kit Number
HB	PS5687P
HA	PS5587P
H1	PS4087DP
H2	PS4187DP
H3	PS4287DP

Quantity 12

Valve to Base Gasket Kits

Valve Size	Standard	Remote Pilot	Dual Pressure #3	Dual Pressure #5
HB	PS5605P*	—	—	—
HA	PS5505P*	—	—	—
H1	PS4005DP	PS4006DP	PS40D3DP	—
H2	PS4105DP	PS4106DP	PS41D3DP	PS41D5DP
H3	PS4205DP	PS4206DP	PS42D3DP	PS42D5DP

Quantity 1

* Quantity 10

H Series ISO & Network Connectivity H Series ISO 15407 & 5599

5599-1 CNOMO Solenoid Kits

Voltage Code	3-pin, 30mm 'L' Coil Kit	2-pin, M12 Euro '6' Coil Kit
19	—	PS2828619P
42	P2FCA442	—
45	P2FCA445	—
49	P2FCA449	—
53	P2FCA453	—
57	P2FCA457	—

Quantity 1

Body Service Kits



Valve Size	2-Position	3-Position		
		APB	CE	PC
HB	PS5601P	PS5602P	PS5603P	PS5604P
HA	PS5501P	PS5502P	PS5503P	PS5504P
H1	PS4001CP	PS4002CP	PS4003CP	PS4004CP
H2	PS4101CP	PS4102CP	PS4103CP	PS4104CP
H3	PS4201CP	PS4202CP	PS4203CP	PS4204CP

HB / HA Kit Includes: Spool assembly with seals.

H1, H2, H3 Kit Includes: Spool assembly with seals, all piston seals, return spring, pilot selector gasket, coil to end cap gasket.

Quantity 1

Pilot Select Gasket Kits

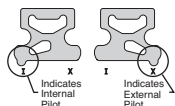
	Valve Size	Part Number
	HB	PS5605P
	HA	PS5505P
	H1, H2 & H3	PS4007P

Quantity 10

Regulator Kits

Valve Size	Part Number
H1	PS4039P
H2, H3	PS4139P

D

Subbase & Manual Valves

H Series Micro

Modulflex Series

H Series ISO

Network Connectivity

DX ISOMAX Series

Valvair II Series



For inventory, lead times, and kit lookup, visit www.pdnplu.com

Accessories

**H Series ISO & Network Connectivity
H Series ISO 15407 & 5599**

Regulator & Flow Control Mounting Studs

Valve Type	Type	Part Number
HB	Flow Control & Regulator	PS5636P
HA	Flow Control & Regulator	PS5536P
H1	Flow Control	PS4036P
	Regulator	PS4040P
H2	Flow Control	PS4136P
	Regulator	PS4140P
H3	Flow Control	PS4236P
	Regulator	PS4240P

Quantity 12

Regulator Gauge Kits – Size H1, H2 & H3

Gauge Type	Part Number
1" Face Air - Standard	
0 to 60 PSIG	PS4051060BP
0 to 160 PSIG	PS4051160BP
1-1/2" Face Air - Large*	
0 to 60 PSIG	PS4053060BP
0 to 160 PSIG	PS4053160BP
1-1/2" Face Liquid*	
0 to 160 PSIG	PS4052160BP

* Includes brass pipe fitting extensions
Quantity 1

Pilot By-Pass Plate

Valve Size	Part Number
H1, H2, H3	PS4051CP

Quantity 10

Installation Bracket

Bracket	Part Number
Bracket and Bolt (Quantity 2)	PSHU60P

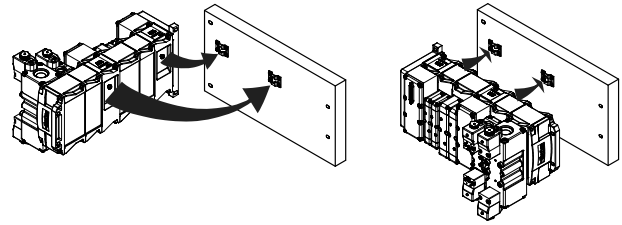

D

Subbase & Manual
Valves

H Series
Micro

Modulflex
Series

H Series
ISO

Network
Connectivity

DX ISOMAX
Series

Valvair II
Series



For inventory, lead times, and kit lookup, visit www.pdnplu.com

H Series ISO 15407-2, Plug-in, Size 18mm (HB)

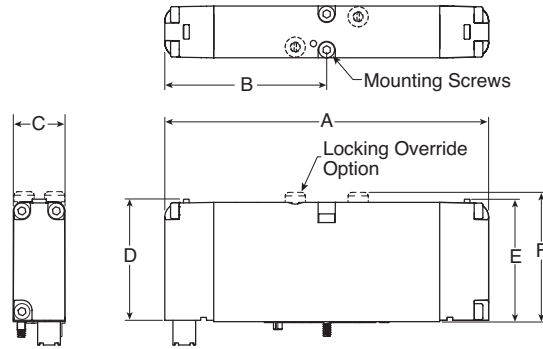

18mm Dimensions

A	B	C	D
4.43 (113)	2.22 (56)	.72 (18)	1.98 (50)
E	F		
1.68 (43)	1.77 (45)		
Inches (mm)			

H Series ISO 15407-2, Plug-in, Size 26mm (HA)

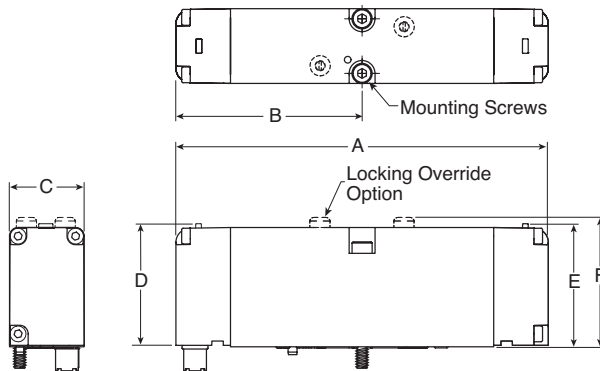

26mm Dimensions

A	B	C	D
5.10 (130)	2.55 (65)	1.02 (26)	1.98 (50)
E	F		
1.68 (43)	1.77 (45)		
Inches (mm)			

H Series ISO 15407-1, Non Plug-in, Size 18mm (HB)

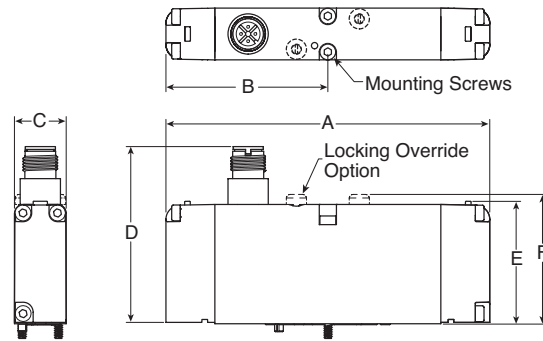

18mm Dimensions

A	B	C	D
4.43 (113)	2.22 (56)	.72 (18)	2.40 (61)
E	F		
1.68 (43)	1.77 (45)		
Inches (mm)			

H Series ISO 15407-1, Non Plug-in, Size 26mm (HA)

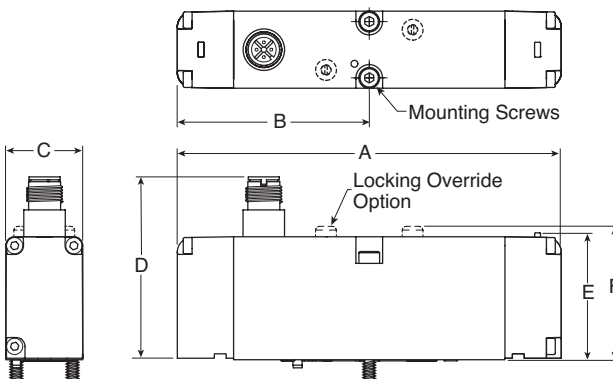

26mm Dimensions

A	B	C	D
5.10 (130)	2.55 (65)	1.02 (26)	2.40 (61)
E	F		
1.68 (43)	1.77 (45)		
Inches (mm)			



For inventory, lead times, and kit lookup, visit www.pdnplu.com

D137

Parker Hannifin Corporation
 Pneumatic Division
 Richland, Michigan
www.parker.com/pneumatics

D

Subbase & Manual Valves

H Series Micro

Moduflex Series

H Series ISO

Network Connectivity

DX ISOMAX Series

Valvair II Series

H Series ISO 5599-2

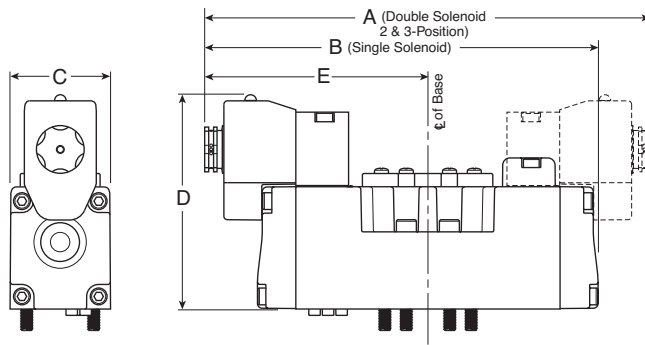

H1 Valves Shown

H1 Dimensions

A	A1	B	C
7.32 (186)	5.59 (142)	6.46 (164)	1.65 (42)

D	D1	D2	D3
3.54 (90)	4.29 (109)	4.29 (109)	2.50 (63.5)

D4	E	E1
2.48 (63)	3.66 (93)	2.80 (71)

Inches
(mm)

H Series ISO 5599-1 Auto

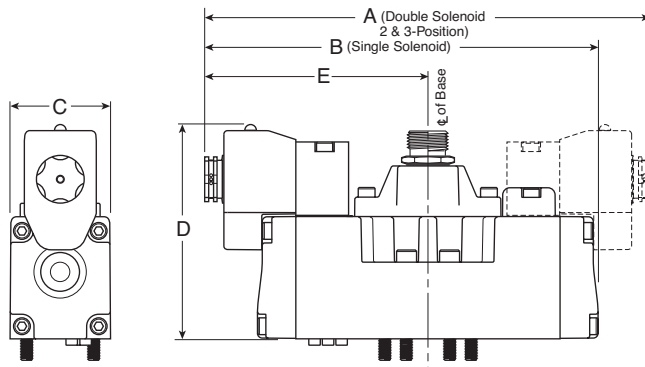

H2 Dimensions

A	A1	B	C
8.35 (212)	6.62 (168)	7.48 (190)	2.17 (55)

D	D1	D2	D3
4.05 (103)	4.80 (122)	4.57 (116)	2.99 (76)

E	E1
4.17 (106)	3.31 (84)

Inches
(mm)

H Series ISO 5599-1 CNOMO

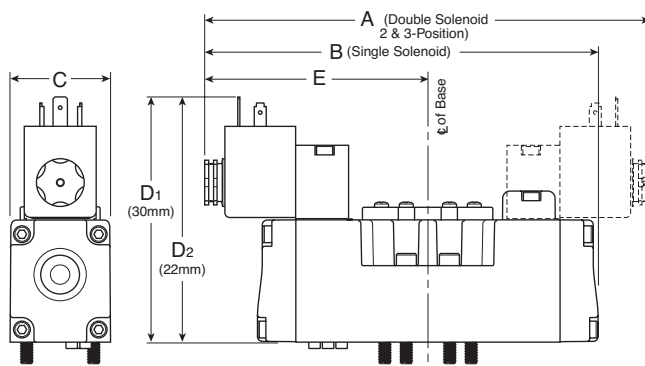

H3 Dimensions

A	A1	B	C
9.68 (246)	6.98 (196.7)	8.68 (220)	2.17 (65.5)

D	D1	D2	D3
4.05 (103)	4.80 (122)	4.57 (116)	2.99 (76)

E	E1
4.74 (121)	3.49 (89)

Inches
(mm)

H Series ISO 5599-2 / 5599-1 Remote Pilot

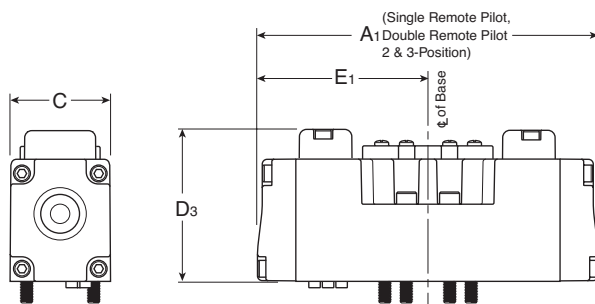

HB Series ISO 15407-1, Size 18mm (HB) Single Subbase

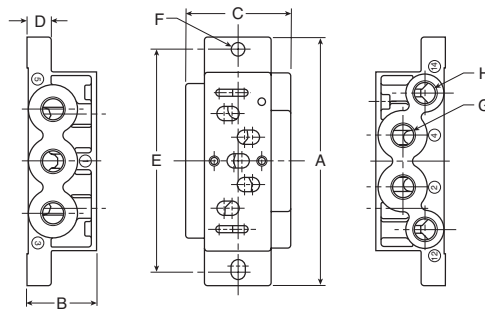

HB Dimensions (PL02)

A	B	C	D
3.15 (80)	.87 (22)	1.06 (27)	.31 (8)
E	F	G	H
2.76 (70)	.216 Dia. (Ø 5.5)	1/8	M5

Inches
(mm)

H Series ISO 15407-2 & 15407-1 Size 26mm (HA), Plug-in Subbases

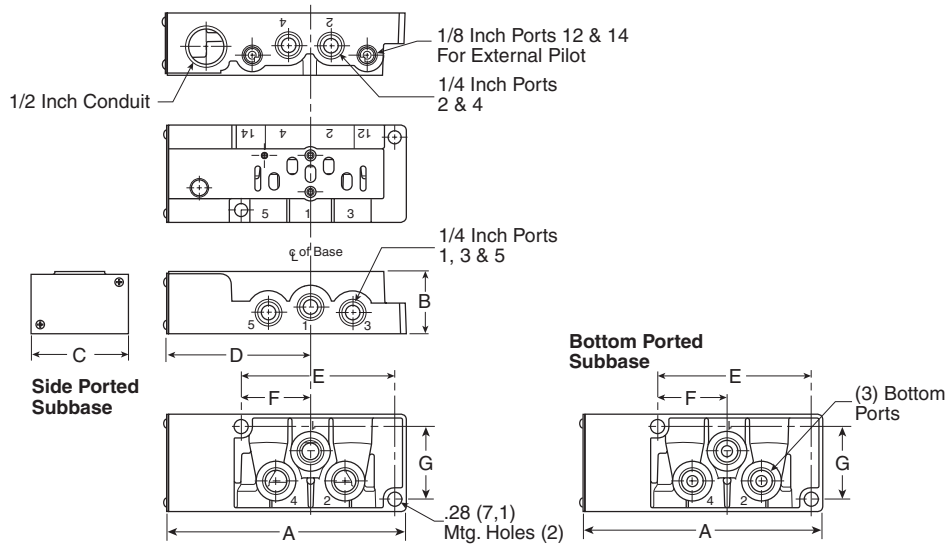

HA Dimensions

A	B	C	D
4.88 (124)	1.28 (32.5)	2.00 (50.8)	2.91 (74)
E	F	G	
1.43 (36.2)	3.16 (80.2)	1.49 (37.9)	

Inches
(mm)

D

Subbase & Manual
Valves

H Series
Micro

Modulflex
Series

H Series
ISO

Network
Connectivity

DX ISOMAX
Series

Valvair II
Series



H Series ISO 5599-1 Size H1, PS4011 Subbase

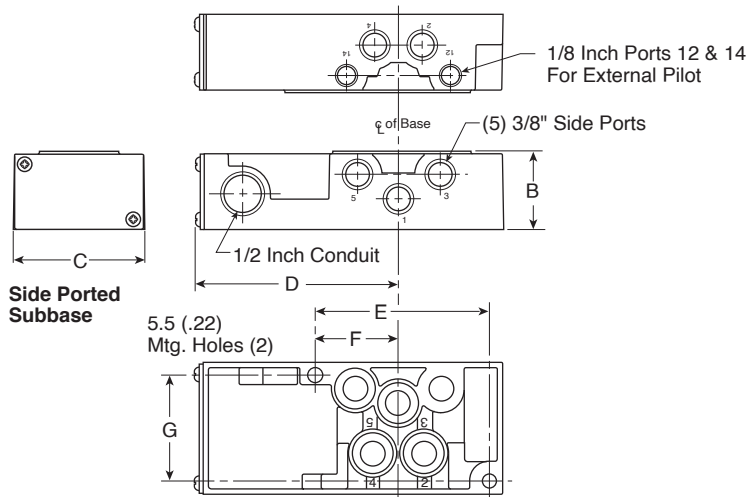

PS4011 Subbase Dimensions

A	B	C	D
5.83 (148)	1.48 (38)	2.50 (64)	3.86 (98)
E	F	G	
3.29 (84)	1.57 (40)	2.00 (51)	

Inches
(mm)

H Series ISO 5599-1 Size H2, PS4111 Subbase

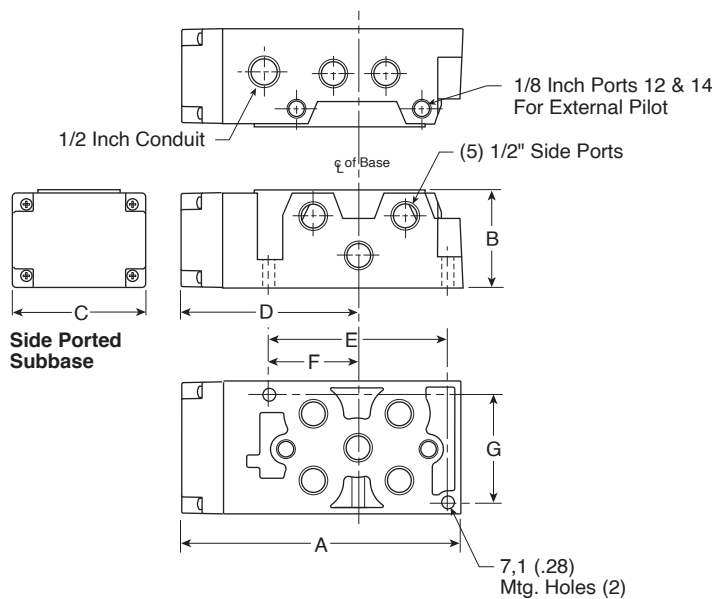

PS4111 Subbase Dimensions

A	B	C	D
6.69 (170)	2.33 (59)	3.15 (80)	4.25 (108)
E	F	G	
4.21 (107)	2.07 (52)	2.56 (65)	

Inches
(mm)

D

Subbase & Manual
Valves

H Series
Micro

Modulflex
Series

H Series
ISO

Network
Connectivity

DX ISOMAX
Series

Valvair II
Series



For inventory, lead times, and kit lookup, visit www.pdnplu.com

H Series ISO 5599-1 Size H3, PS4211 Subbase

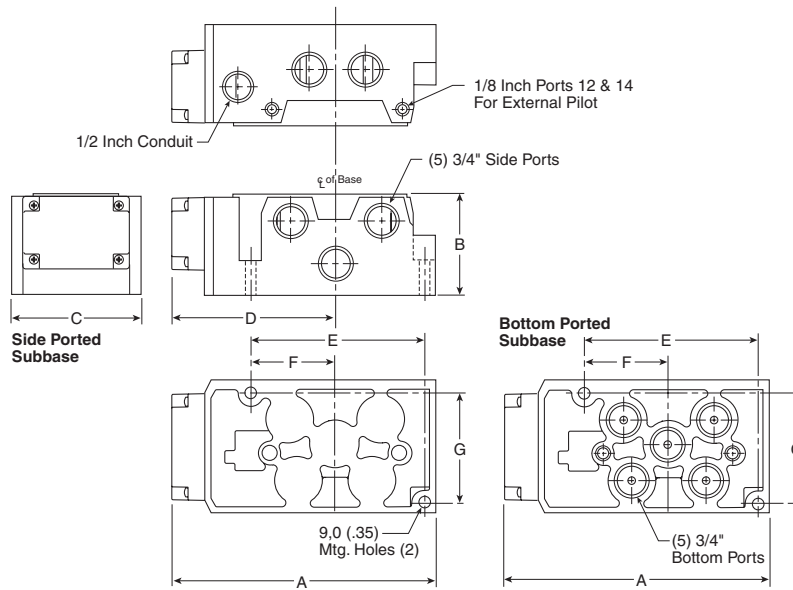

PS4211 Subbase Dimensions

A	B	C	D
7.90 (201)	2.96 (75)	3.90 (99)	4.92 (125)
E	F	G	
5.14 (131)	2.50 (64)	3.24 (82)	

Inches
(mm)

H Series ISO 5599 Size H3, PS4211 Manifold

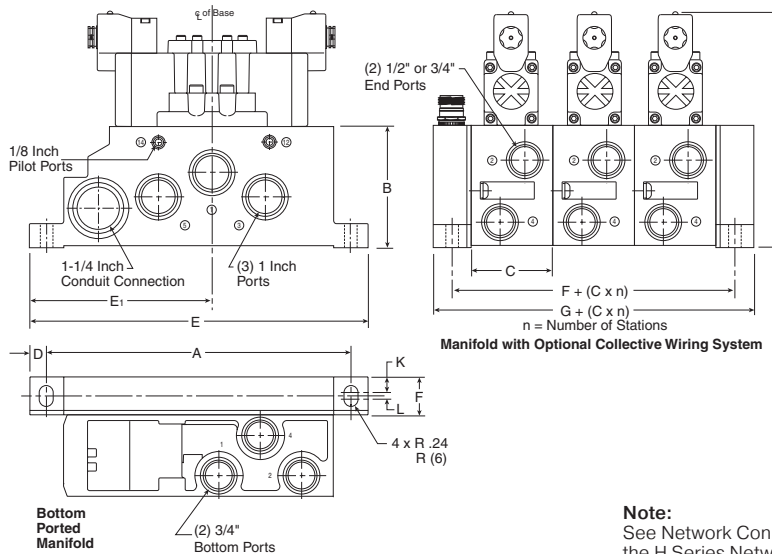

PS4211 Manifold Dimensions

A	B	C	D	E
10.41 (265)	4.13 (105)	2.80 (71)	.59 (15)	11.61 (295)
E1	F	G	H	
6.26 (159)	1.30 (33)	2.60 (63)	8.19 (208)	
K	L			
.53 (13.5)	.24 (6)			

Inches
(mm)

Note:
 See Network Connectivity Section for the dimensions of manifolds utilizing the H Series Network, Turck Network, or P2M Network Node end plate type.

H Series ISO Universal Manifold

Network Connectivity dimensions (P2H, Turck, H Net, and P2M) are located at the end of the Network Connectivity Section.

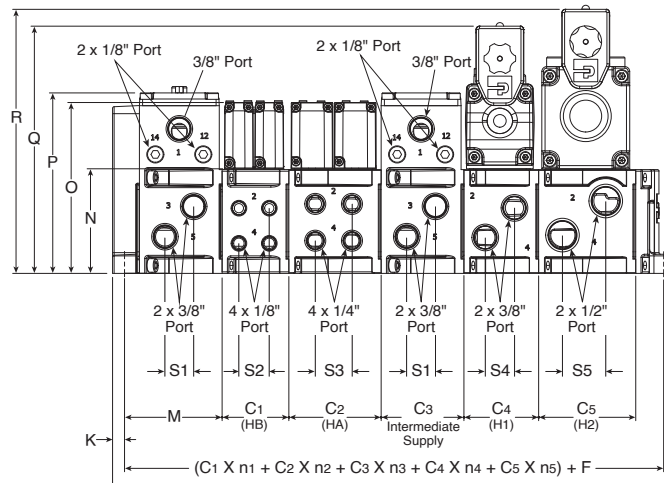
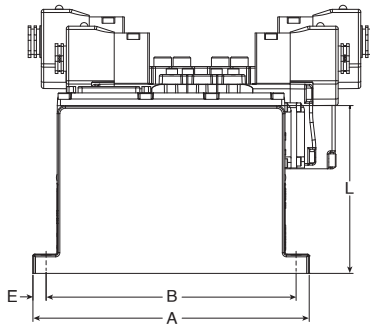
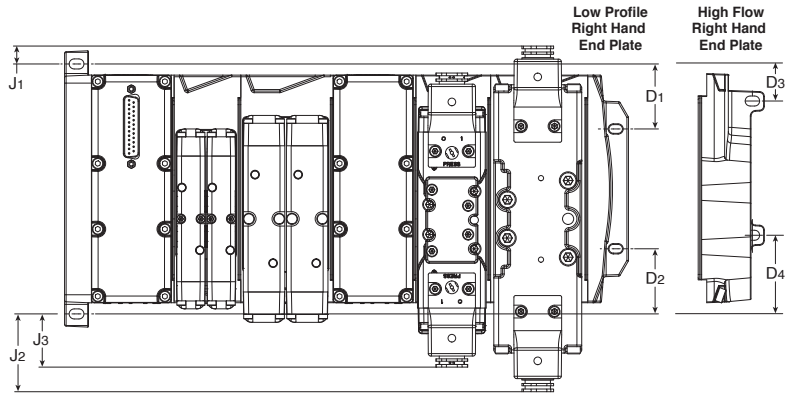

A	B	C1	C2	C3	C4	C5
6.81 (172.95)	6.16 (156.5)	1.65 (41.79)	2.28 (57.79)	2.04 (51.79)	1.84 (46.79)	2.39 (60.79)
D1	D2	D3	D4	E	F	G
1.60 (40.71)	1.60 (40.71)	0.96 (24.3)	1.92 (48.8)	0.32 (8.0)	3.09 (78.58)	4.39 (111.58)
J1	J2	J3	K	L	M	N
0.44 (11.2)	1.92 (48.7)	1.31 (33.3)	0.30 (7.5)	4.14 (105.08)	2.40 (61.08)	1.92 (48.7)
O	P	Q	R	S1	S2	S3
4.21 (107)	4.45 (113)	6.09 (154.77)	6.51 (165.32)	0.71 (18)	0.75 (19)	0.91 (23)
S4	S5					
0.72 (18.3)	1.07 (27.1)					

Inches
(mm)

D

Subbase & Manual Valves

H Series Micro

Modulflex Series

H Series ISO

Network Connectivity

DX ISOMAX Series

Valvair II Series



For inventory, lead times, and kit lookup, visit www.pdnplu.com

D142

Parker Hannifin Corporation
 Pneumatic Division
 Richland, Michigan
www.parker.com/pneumatics

H Series ISO Universal Manifold with H3 Transition

Network Connectivity dimensions (P2H, PCH and Turck Network) are located at the end of the Network Connectivity Section.

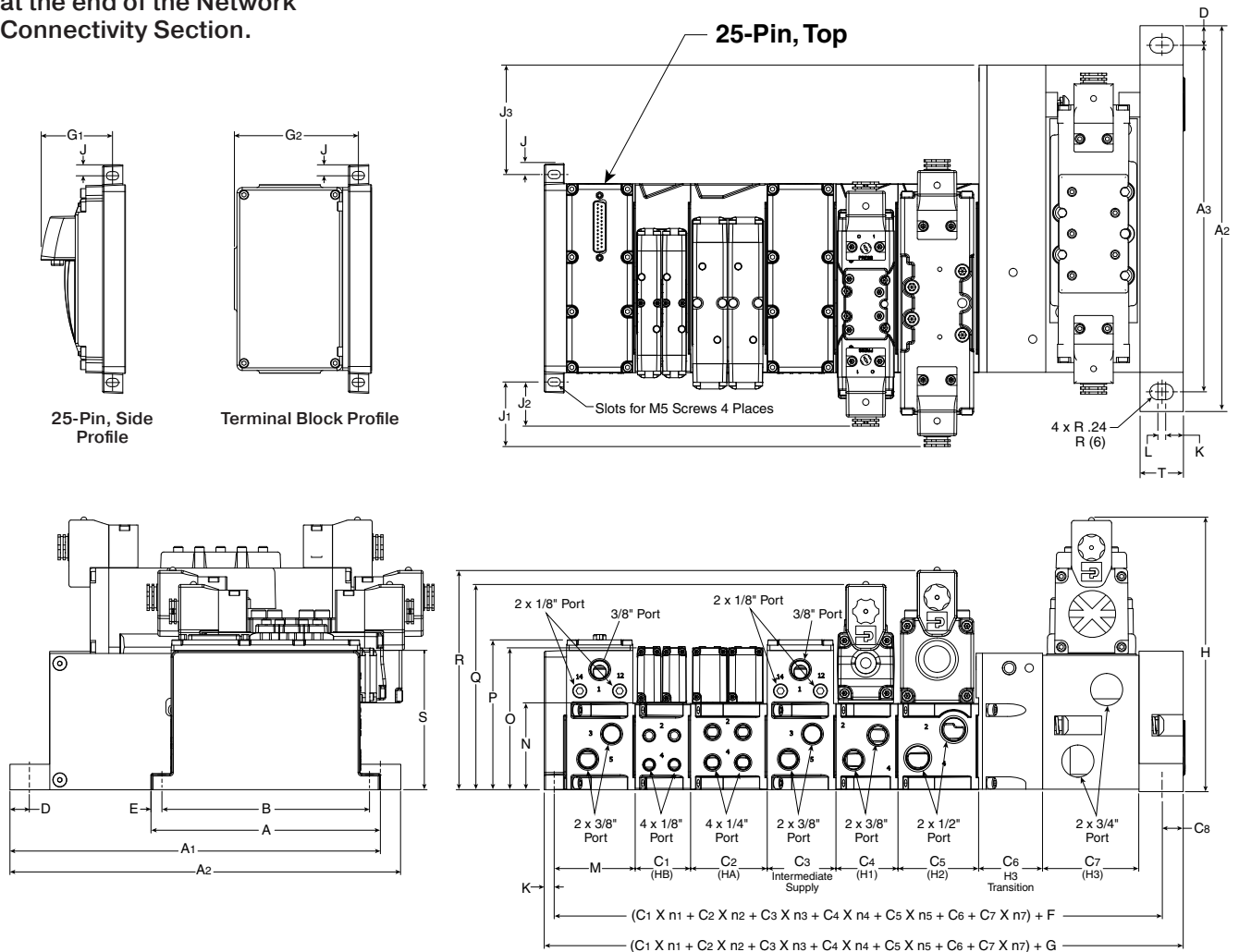

A	A1	A2	A3	B	C1	C2	C3	C4	C5	C6	C7
6.81 (172.95)	12.34 (313.43)	14.0 (365.3)	10.41 (265)	6.16 (156.5)	1.65 (41.79)	2.28 (57.79)	2.04 (51.79)	1.84 (46.79)	2.39 (60.79)	2.00 (51.0)	2.80 (71.0)
C8	D	E	F	G	G1	G2	H	J	J1	J2	J3
0.95 (16.5)	0.59 (15.0)	0.32 (8.0)	3.05 (77.58)	4.00 (101.6)	2.13 (54.0)	3.69 (93.8)	8.19 (208)	0.33 (8.3)	1.92 (48.7)	1.31 (33.3)	3.47 (88.25)
K	L	M	N	O	P	Q	R	S	T		
0.30 (7.5)	0.24 (6.0)	2.40 (61.08)	1.92 (48.7)	4.21 (107)	4.45 (113)	6.09 (154.77)	6.51 (165.32)	4.14 (105.08)	1.30 (33.0)		

Inches
(mm)

D
 Subbase & Manual Valves
 H Series Micro
 Moduflex Series
 H Series ISO
 Network Connectivity
 DX ISOMAX Series
 Valvair II Series



For inventory, lead times, and kit lookup, visit www.pdnplu.com

D143

Parker Hannifin Corporation
 Pneumatic Division
 Richland, Michigan
www.parker.com/pneumatics

25-Pin Side with H Series ISO Valves

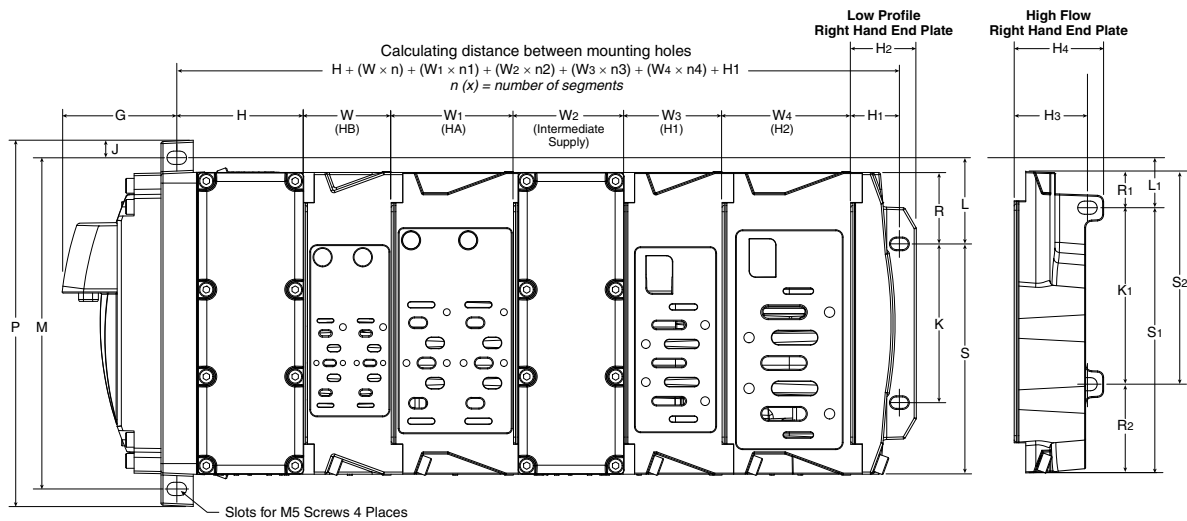

n (x) = number of segments

G	H	H1	H2	H3	H4	J	K	K1	L	L1	M
2.13 (54.0)	2.36 (60.0)	0.90 (23.0)	1.22 (31.0)	1.36 (34.6)	1.66 (42.3)	0.33 (8.3)	2.95 (75.0)	3.28 (83.4)	1.60 (40.7)	0.96 (24.3)	6.16 (156.5)
P	S	S1	S2	R	R1	R2	W	W1	W2	W3	W4
6.81 (173.1)	4.28 (108.8)	4.93 (125.2)	3.96 (100.7)	1.33 (33.7)	0.68 (17.3)	1.6 (41.8)	1.63 (41.3)	2.28 (57.8)	2.06 (52.3)	1.82 (46.3)	2.39 (60.8)

Inches
(mm)

Hi-Flow Right Hand End Plate

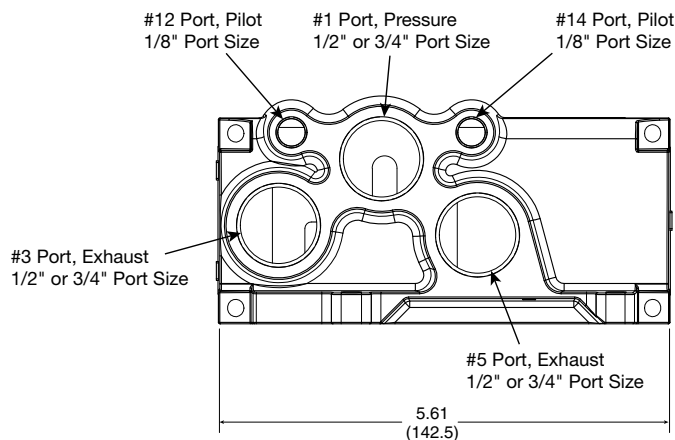

Hi-Flow Right Hand End Plate

PSHU41 1/2" port size

PSHU42 3/4" port size

Inches (mm)

Terminal Block with H Series ISO Valves

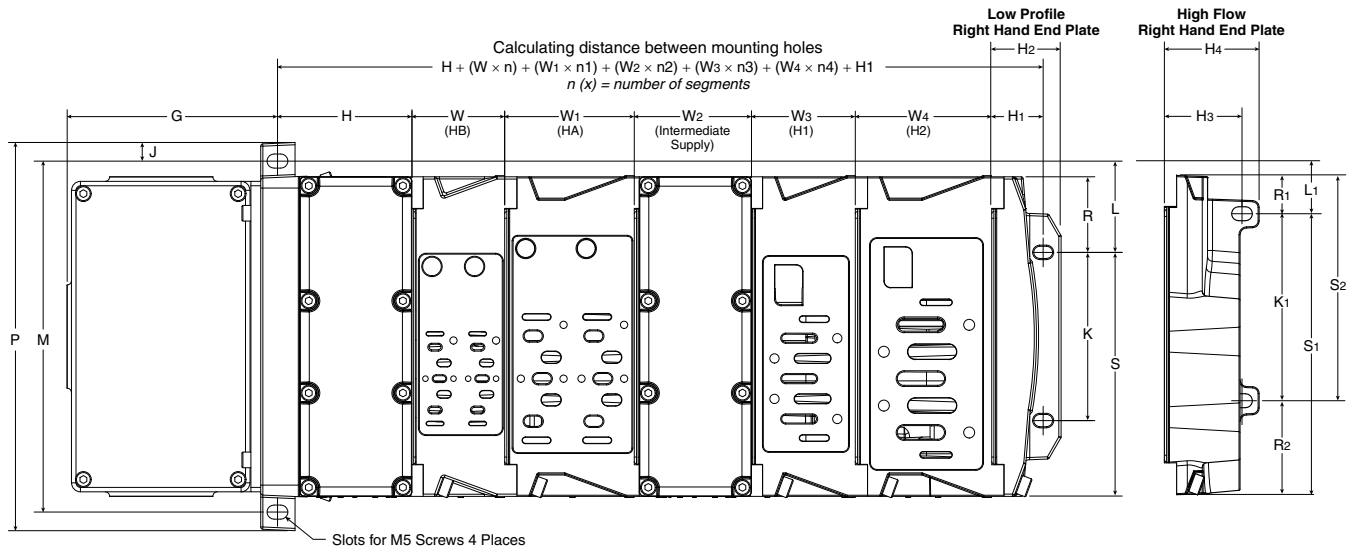

n (x) = number of segments

G	H	H1	H2	H3	H4	J	K	K1	L	L1	M
3.69 (93.8)	2.36 (60.0)	0.90 (23.0)	1.22 (31.0)	1.36 (34.6)	1.66 (42.3)	0.33 (8.3)	2.95 (75.0)	3.28 (83.4)	1.60 (40.7)	0.96 (24.3)	6.16 (156.5)
P	S	S1	S2	R	R1	R2	W	W1	W2	W3	W4
6.81 (173.1)	4.28 (108.8)	4.93 (125.2)	3.96 (100.7)	1.33 (33.7)	0.68 (17.3)	1.65 (41.8)	1.63 (41.3)	2.28 (57.8)	2.06 (52.3)	1.82 (46.3)	2.39 (60.8)

Inches
(mm)

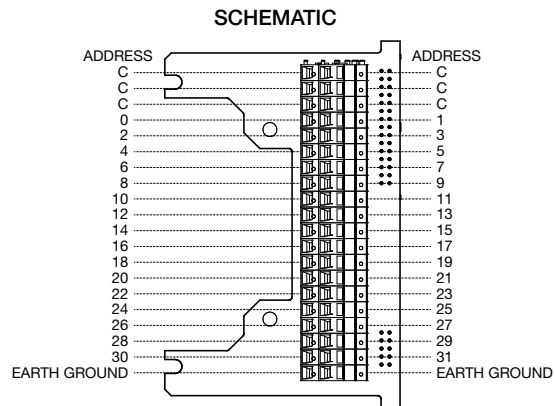
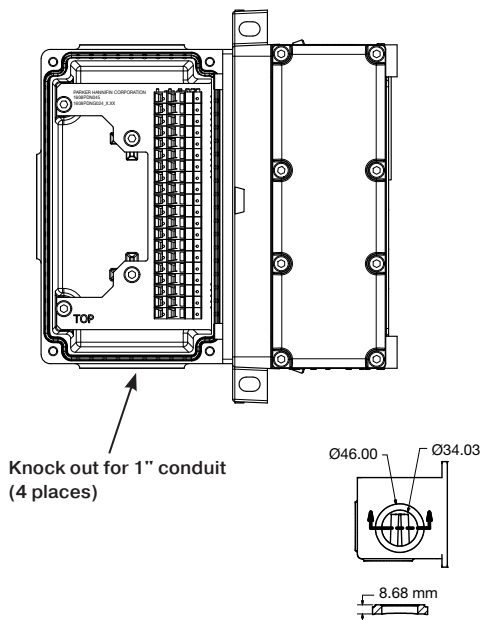

All commons internally
connected on terminal strip



For inventory, lead times, and kit
lookup, visit www.pdnplu.com

D145

Parker Hannifin Corporation
 Pneumatic Division
 Richland, Michigan
www.parker.com/pneumatics

D

Subbase & Manual
Valves

H Series
Micro

Moduflex
Series

H Series
ISO

Network
Connectivity

DX ISOMAX
Series

Valvair II
Series

H Series ISO 15407, HB / HA Sandwich Regulator

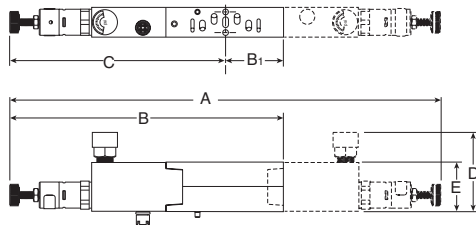

HB / HA Series Sandwich Regulator, Dimensions

	A	B	B1	C	D	E
HB (PS5637)	10.28 (261)	6.14 (156)	1.02 (26)	5.13 (130)	2.60 (66)	1.18 (30)
HA (PS5537)	10.00 (254)	6.42 (163)	1.42 (36)	5.00 (127)	2.72 (69)	1.18 (30)

Inches
(mm)

H Series ISO 5599, Size H1 Sandwich Regulator

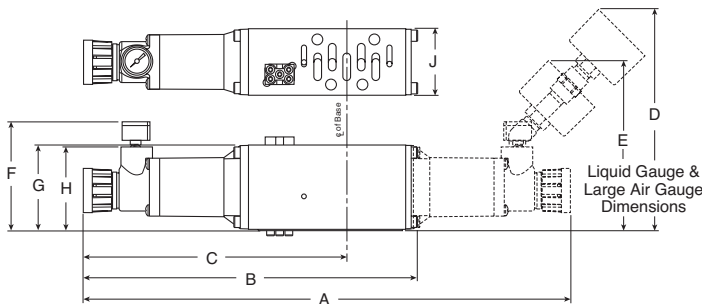

H1 Series Sandwich Regulator, Dimensions

	A	B	C	D	E	F
H1 (PS4037)	11.84 (301)	8.13 (207)	6.40 (163)	5.45 (138)	4.25 (108)	2.85 (72)
(PS4038)						
	G	H	J			
	2.09 (53)	2.05 (52)	1.63 (41)			

Inches
(mm)

H Series ISO 5599, Size H2 & H3 Sandwich Regulator

H2 Sandwich Regulator shown

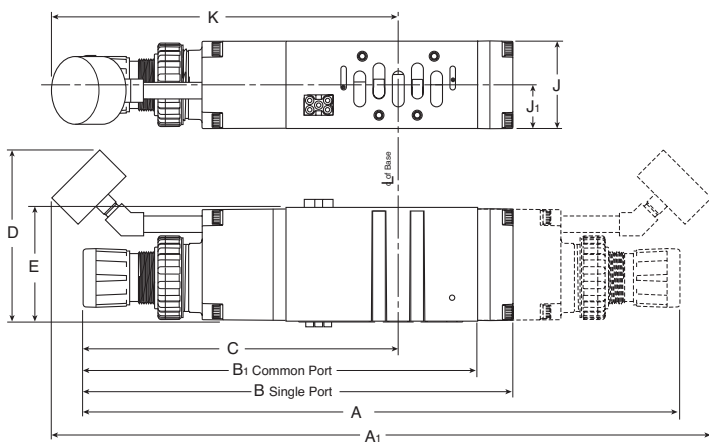

H2 & H3 Series Sandwich Regulator, Dimensions

	A	A1	B	B1	C	D
H2 (PS4137)	14.65 (372)	16.18 (411)	10.56 (268)	9.84 (250)	7.71 (196)	4.20 (107)
(PS4138)						
	E	J	J1	K		
	2.80 (71)	2.15 (55)	1.07 (27)	8.50 (216)		
H3 (PS4237)	A	A1	B	B1	C	D
(PS4238)	15.67 (398)	17.15 (436)	11.53 (293)	10.67 (271)	8.37 (213)	4.20 (107)
	E	J	J1	K		
	2.93 (75)	2.50 (64)	1.25 (32)	9.10 (231)		

Inches
(mm)

- D
- Subbase & Manual Valves
- H Series Micro
- Modulflex Series
- H Series ISO
- Network Connectivity
- DX ISOMAX Series
- Valvair II Series



For inventory, lead times, and kit lookup, visit www.pdnplu.com

H Series ISO 15407, Size 18mm (HB) & 26mm (HA), Flow Control

HA Flow Control

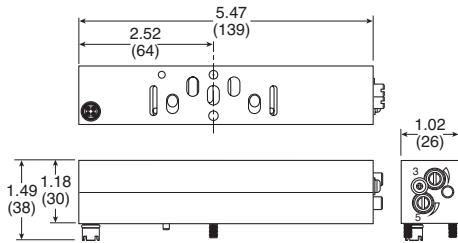

HB Flow Control

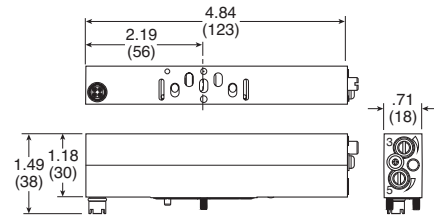

H Series ISO 5599, Size H1, H2 & H3, Flow Control

H1 Flow Control

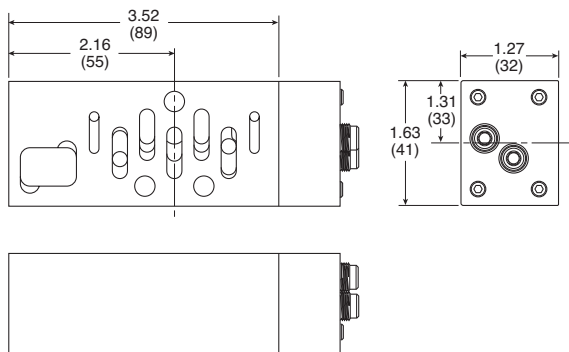

H2 Flow Control

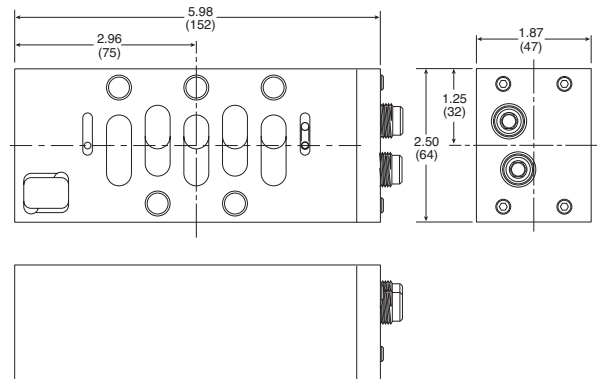

H3 Flow Control

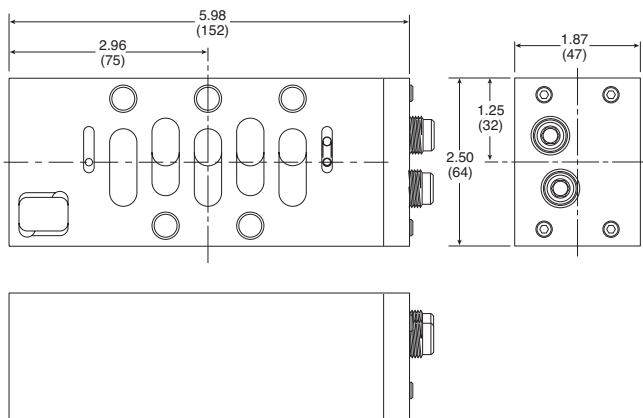

D	Subbase & Manual Valves
	H Series Micro
	Moduflex Series
	H Series ISO
	Network Connectivity
DX ISOMAX Series	
Valvair II Series	



For inventory, lead times, and kit lookup, visit www.pdnplu.com

D147

Parker Hannifin Corporation
 Pneumatic Division
 Richland, Michigan
www.parker.com/pneumatics

D

Subbase & Manual
Valves

H Series
Micro

Modulflex
Series

H Series
ISO

Network
Connectivity

DX ISOMAX
Series

Valvair II
Series



For inventory, lead times, and kit
lookup, visit www.pdnplu.com

D148

Parker Hannifin Corporation
Pneumatic Division
Richland, Michigan
www.parker.com/pneumatics

Network Connectivity

Offering

Valve series	P2M	P2H IO-Link	P2H Ethernet	PCH	Turck BL67
Moduflex	X				
H Series Micro	X				X
H Series ISO		X	X	X	X

Protocol	P2M	P2H IO-Link	P2H Ethernet	PCH	Turck BL67
IO-Link	X	X		X	
DeviceNet					X
EtherNet/IP™	X		X	X	X
Profibus-DP					X
Profinet	X		X	X	X
Modbus/TCP	X		X	X	X
EtherCAT	X		X	X	
PowerLink	X		X		
CANopen					X

Options	P2M	P2H IO-Link	P2H Ethernet	PCH	Turck BL67
24 Solenoid control	X*	X			X
32 Solenoid control			X	X	X
Digital inputs / outputs				X	X
Analog inputs / outputs					X
Class A IO-Link master module				X	X
Class B IO-Link Master module				X	
Short circuit protection on inputs				X	X
Current sensing outputs				X	X
DeviceNet subnet					X
Power over DeviceNet / CANopen					X
CANopen expansion					X

* Only 19 usable when used with Moduflex Valve

P2M Network Nodes (shown on H Micro & Moduflex)



Moduflex

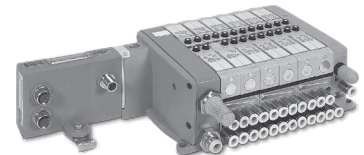

H Micro

P2H Network Node: IO-Link (shown on H Series ISO)

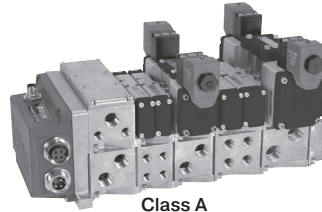

Class A

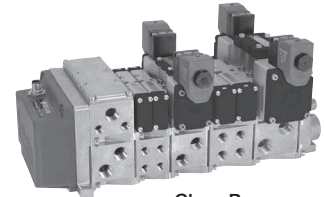

Class B

P2H Network Node: Industrial Ethernet (shown on H Series ISO)

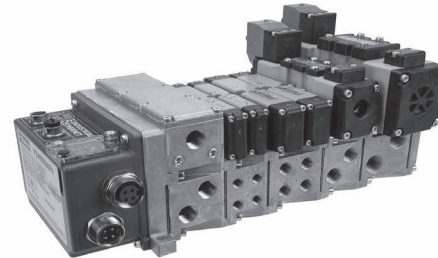

PCH Network Portal (shown on H Series ISO)

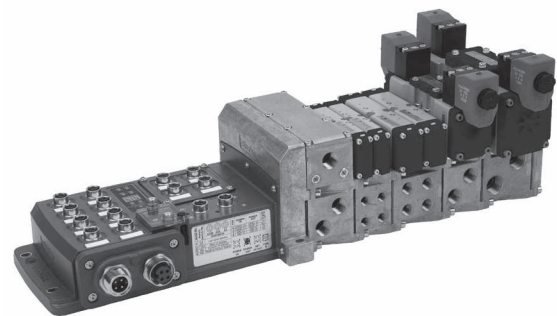

Turck Network Portal (shown on H Series ISO)

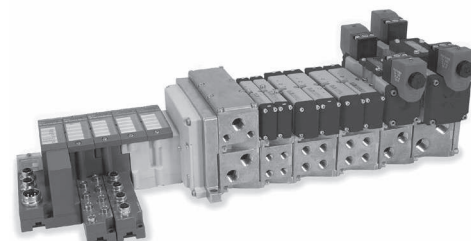

D

Subbase & Manual Valves

H Series Micro

Moduflex Series

H Series ISO

Network Connectivity

DX ISOMAX Series

Valvair II Series

Industrial Ethernet

Parker's extensive Network Connectivity portfolio can help lower cost of I/O in any control architecture.

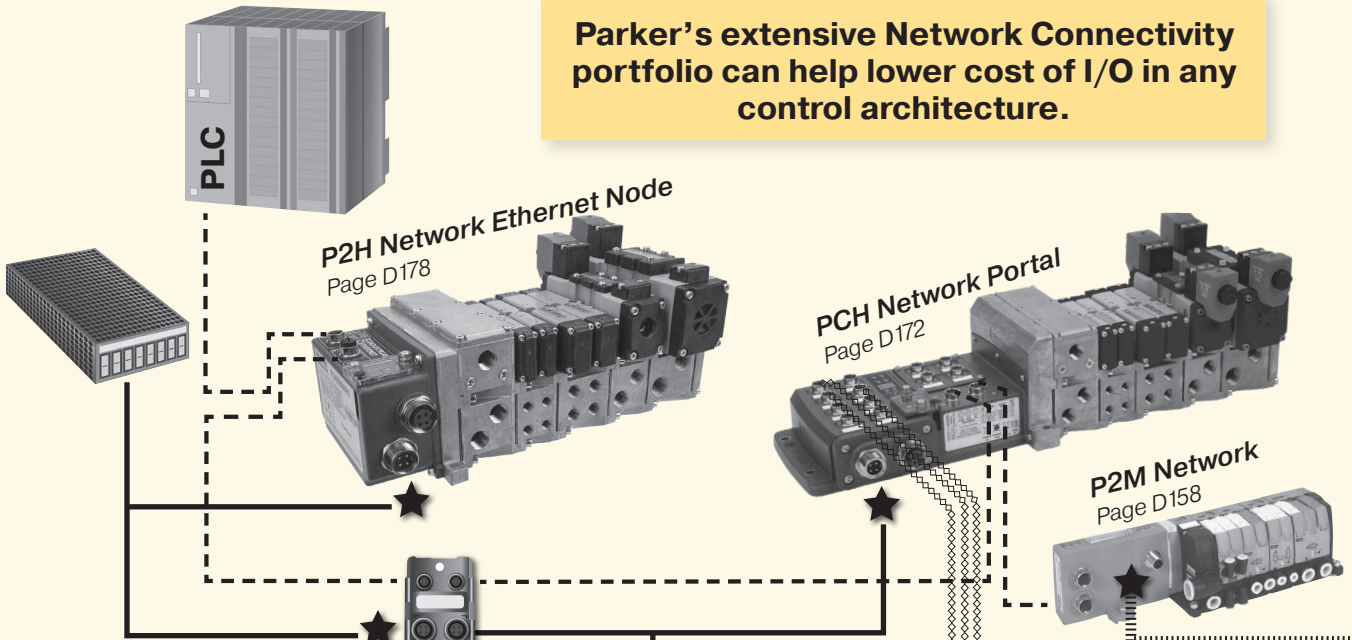

IO-Link

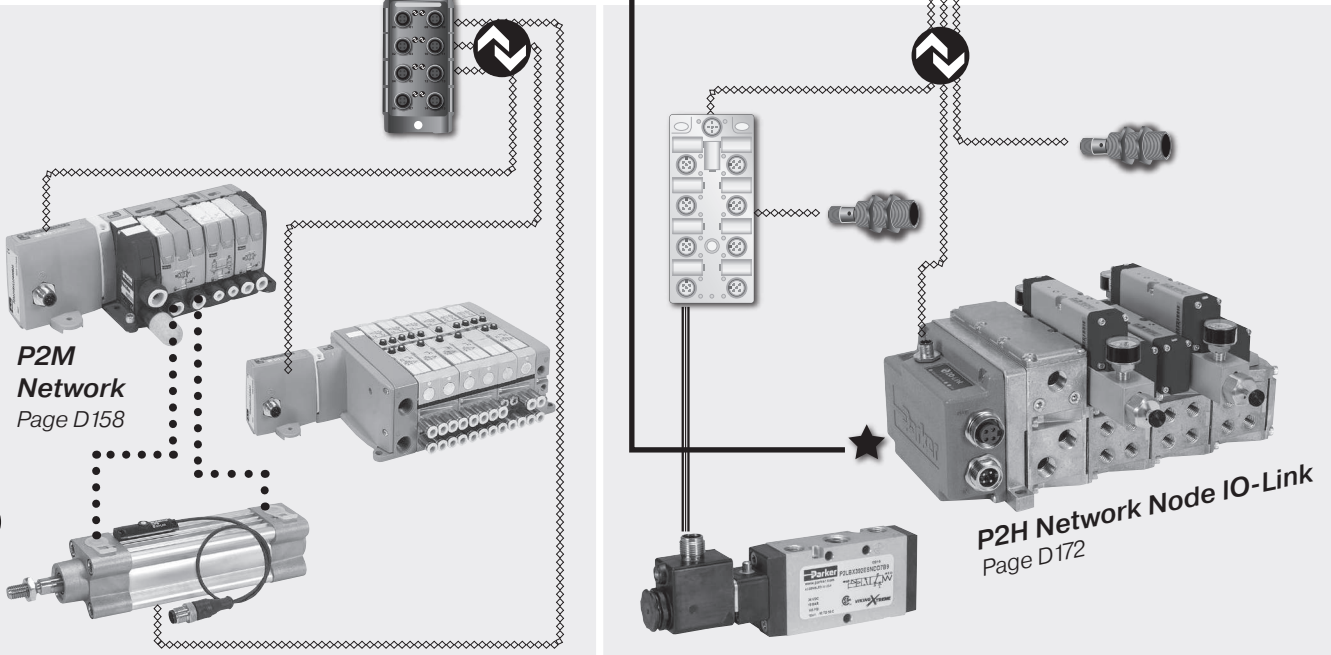

Network to Remote IO-Link Master
 Reduce cabinet size by using a de-centralized "on-machine" IO-Link Master

- * Control all local I/O with IO-Link Masters
 - Discrete I/O
 - "Smart" I/O
 - P2M IO-Link Class B & CPS pictured
 see www.parker.com/pdn/CPS
 and www.parker.com/pdn/P2M_IOL

Node Expansion Using IO-Link
 Reduce node count by adding an IO-Link Master module onto Turck Network manifold

- * 20m max length for I/O-Link cables
- * Control all "smart I/O" on 1 node
- * Reduce cost of secondary valve manifold
 - P2H IO-Link Class A pictured
 see www.parker.com/pdn/P2H_IOL

D	Subbase & Manual Valves
H Series Micro	Modulflex Series
H Series ISO	Network Connectivity
DX ISOMAX Series	Valvair II Series



For inventory, lead times, and kit lookup, visit www.pdnplu.com

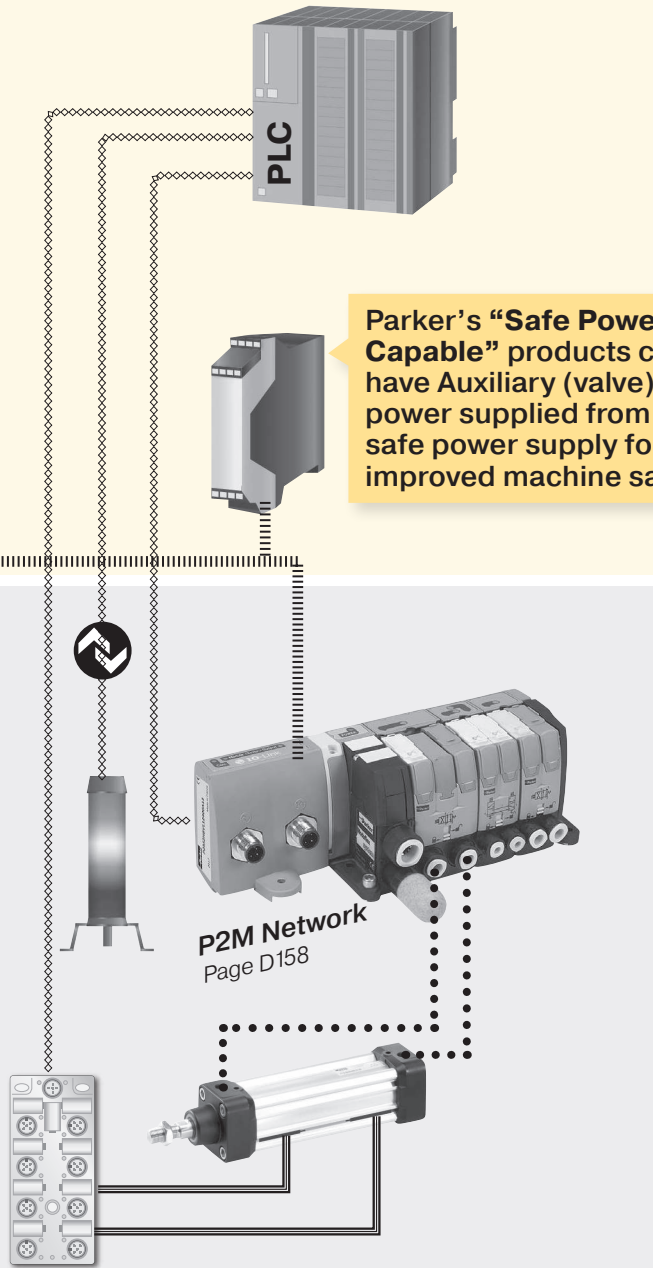

Parker's "Safe Power Capable" products can have Auxiliary (valve) power supplied from a safe power supply for improved machine safety.

---	Industrial Network
⋈⋈⋈⋈⋈	IO-Link
====	Discrete Wired Input / Output
—★	24 VDC Power
⋈⋈⋈⋈⋈★	24 VDC SAFE Power
•••••	Pneumatic

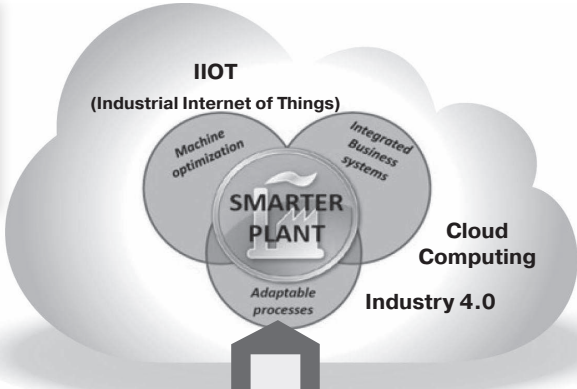

IO-Link is another step towards the smarter plant by lowering the cost for gathering component level prognostics and diagnostics.

Out of Tolerance Warnings

- * Voltage
- * Temperature

Error Descriptors

- * Solenoid short circuit
- * IO-Link communication error cycle count for each valve

Non-Network I/O Control Using IO-Link
 Use PLC with integrated IO-Link Master for machines with smaller I/O counts

- * 20m max length for I/O-Link cables
- * Control all local I/O with IO-Link
 - Discrete I/O
 - "Smart" I/O
 - P2M IO-Link Class A pictured

- THIS IS EASIER** → Faster installation than discrete wiring
Standard IP67 M12 cable
- THIS IS SAVINGS** → Fewer network nodes
Easy expandability
- THIS IS VALUE** → Easy access diagnostics
Prognostics to prevent downtime

D	Subbase & Manual Valves
H Series	Micro
Moduflex	Series
H Series	ISO
Network	Connectivity
DX ISOMAX	Series
Valvair II	Series



For inventory, lead times, and kit lookup, visit www.pdnplu.com

System Overview - Discrete Wiring

- Up to 24 solenoids per manifold (19 when used with Moduflex Valve)
- Discretely wired solenoids - optimized for PLCs with onboard inputs and outputs
- 25-Pin D-Sub, 19-Pin Brad Harrison or M23, or 12-Pin M23 connectors available

Centralized Application

Valves Inside Control Cabinet

- Valves located near machine control
- Applications with caustic wash down, hazardous areas, or extreme temperatures

Disadvantages

- Difficult to troubleshoot
- Difficult to maintain
- Expensive bulkhead fittings
- Long wiring time in cabinet

De-centralized Application

Valves Outside Control Cabinet

- Valves located near application - ready for machine mounting
- IP65 rating suitable for dusty and wet environments

Disadvantages

- Difficult to troubleshoot
- Difficult to maintain
- Long wiring time in cabinet
- Long wiring time in junction box

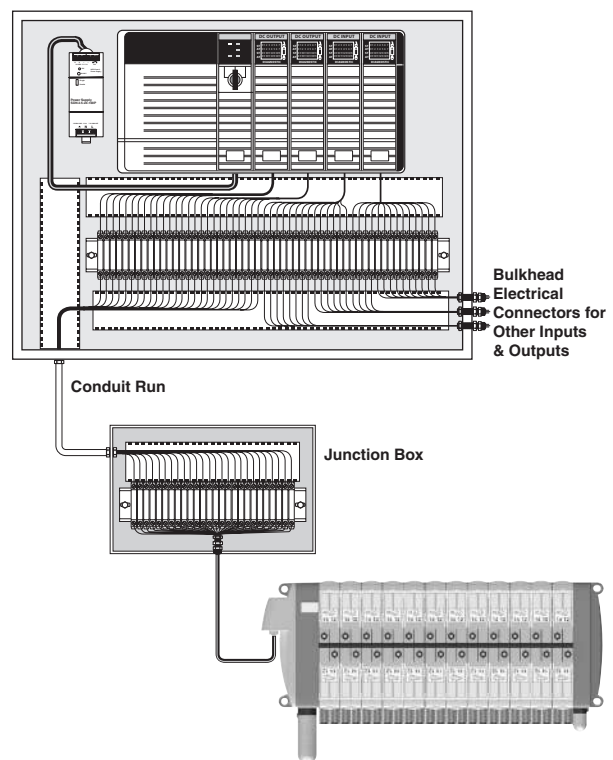
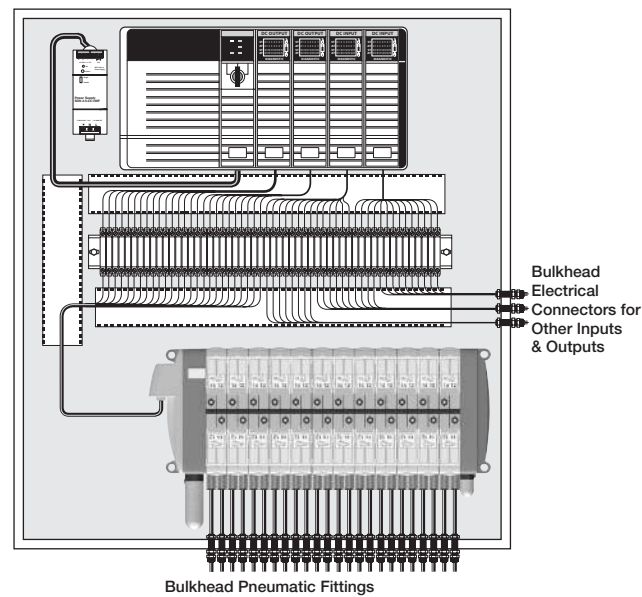

D	Subbase & Manual Valves
H Series Micro	Moduflex Series
H Series ISO	Network Connectivity
DX ISOMAX Series	Valvair II Series



For inventory, lead times, and kit lookup, visit www.pdnplu.com

System Overview - P2M Network Node

- Up to 24 solenoids per manifold (19 when used with Moduflex Valve)
- Optimized for PLCs with network capability
- Routinely used on medium sized machines
- Connectivity to Moduflex, H Series Micro and H Series ISO valves

Centralized Application

Valves Inside Control Cabinet

- Valves located near machine control
- Applications with caustic wash down, hazardous areas, or extreme temperatures
- Additional inputs and outputs are not directly attached to valve manifold

Advantages

- Highest degree of environmental protection
- One location for all control devices
- Small size requires minimal cabinet space
- Eliminates terminal strips and wire ways for valves
- Greatly reduces wiring time
- Eliminates junction boxes for valves
- Eliminates conduit runs for valves

De-centralized Application

H Series Micro Outside Control Cabinet

- Valves located near application - ready for machine mounting
- IP65 rating suitable for dusty and wet environments
- Additional inputs and outputs are not directly attached to valve manifold

Advantages

- Smallest control cabinet
- Reduces tubing length and improves pneumatic response time
- Eliminates pneumatic bulk fittings on control cabinet
- Many network nodes can be attached to the network with little incremental cost – valve manifolds, inputs, outputs and other devices
- Eliminates terminal strips and wire ways for valves
- Greatly reduces wiring time
- Eliminates junction boxes for valves
- Eliminates conduit runs for valves

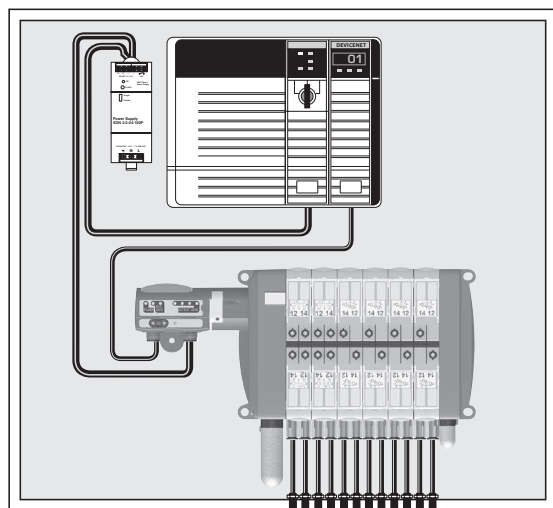

Bulkhead Pneumatic Fittings

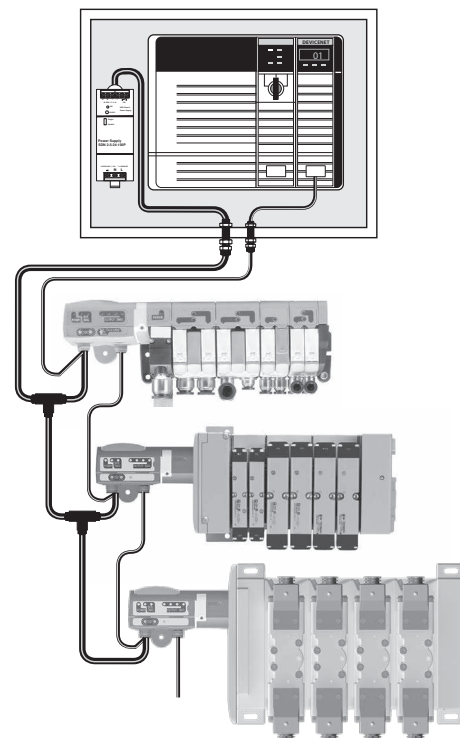

For inventory, lead times, and kit lookup, visit www.pdnplu.com

D	Subbase & Manual Valves
	H Series Micro
	Moduflex Series
	H Series ISO
	Network Connectivity
	DX ISOMAX Series
	Valvair II Series

System Overview - Turck Network Portal

General Product Features

- Turck Network Portal with up to 256 inputs / outputs and up to 16 or 32 solenoids per manifold
- Digital inputs / outputs, IO-Link Class A Master analog inputs / outputs, serial interface, counter modules, and RFID modules available
- Connectivity to H Series Micro and H Series ISO valve series

Advantages

- Handle all I/O from one node; eliminate PLC input / output cards
- Optimized for PLC's with network capability
- Eliminates junction boxes, terminal strips, and conduit runs for all inputs and outputs, greatly reducing wiring time

Centralized Application

Valves Inside Control Cabinet

- Valves located near machine control
- Applications with caustic wash down, hazardous areas, or extreme temperatures

Advantages

- Highest degree of environmental protection
- One location for all control devices
- Small size requires minimal cabinet space

De-centralized Application

Valves Outside Control Cabinet

- Valves located near application - ready for machine mounting
- IP65 rating suitable for dusty and wet environments

Advantages

- Smallest control cabinet
- Reduces tubing length and improves response time
- Eliminates pneumatic bulk fittings on control cabinet

D

Subbase & Manual
Valves

H Series
Micro

Modulflex
Series

H Series
ISO

Network
Connectivity

DX ISOMAX
Series

Valvair II
Series

EtherNet/IP™



Modbus/TCP™

DeviceNet™



CANopen

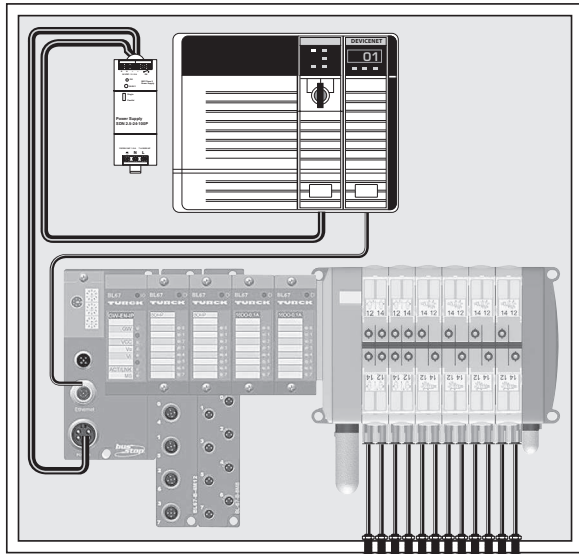

Bulkhead Pneumatic Fittings

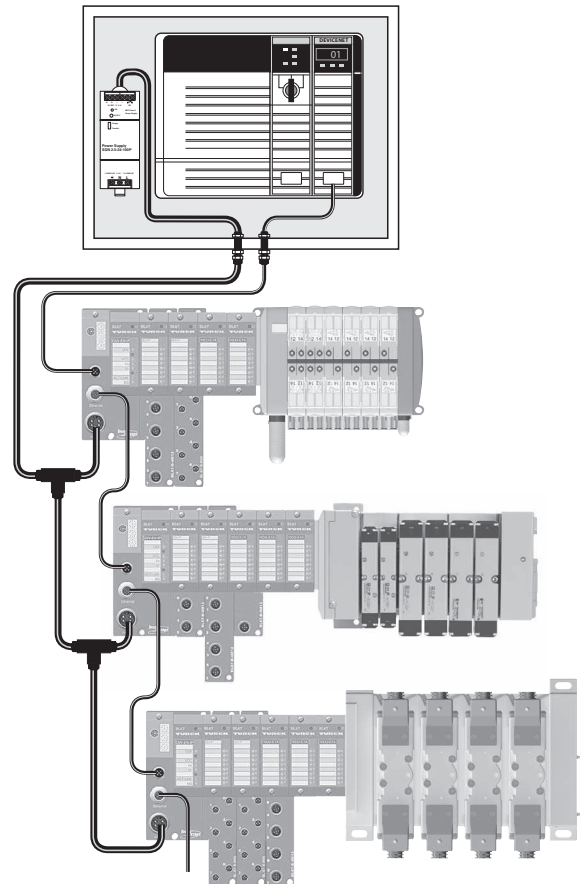

For inventory, lead times, and kit lookup, visit www.pdnplu.com

System Overview - Turck Network Portal with CANopen Expansion

General Product Features

- Turck Network Portal with up to 256 inputs / outputs and up to 16 or 32 solenoids per manifold
- Digital inputs / outputs, IO-Link Class A Master analog inputs / outputs, serial interface, counter modules, and RFID modules available
- Connectivity to H Series Micro and H Series ISO valves

CANopen Expansion Features

- Using a CANopen interface module, a CANopen subnet is created within the Turck Network Portal, controlling an additional 64 inputs, outputs, or solenoids
- The CANopen subnet is independent of the main network, and is not visible to the master PLC
- Additional P2M CANopen modules can be attached to the CANopen subnet to provide a connection for 16 solenoids each
- Other 3rd party CANopen devices can also be used on this network, within the 64 bit CANopen expansion limit

System Advantages

- Handle all I/O from one node; eliminate PLC input / output cards
- Optimized for PLC's with network capability
- Several CANopen nodes can be attached to the network – valve manifolds, inputs, outputs or other devices
- CANopen expansion allows additional devices to be attached to the system without a CANopen scanner card
- Eliminates junction boxes, terminal strips, and conduit runs for all inputs and outputs, greatly reducing wiring time

Centralized Application

Valves Inside Control Cabinet

- Valves located near machine control
- Applications with caustic wash down, hazardous areas, or extreme temperatures

Advantages

- Highest degree of environmental protection
- One location for all control devices
- Small size requires minimal cabinet space

De-centralized Application

Valves Outside Control Cabinet

- Valves located near application - ready for machine mounting
- IP65 rating suitable for dusty and wet environments

Advantages

- Smallest control cabinet
- Reduces tubing length and improves response time
- Eliminates pneumatic bulk fittings on control cabinet

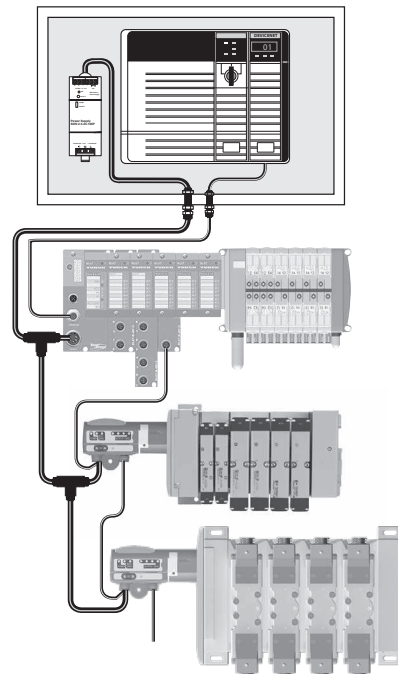
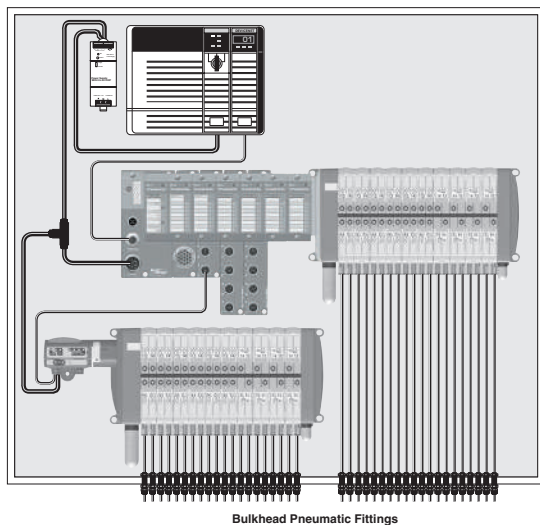
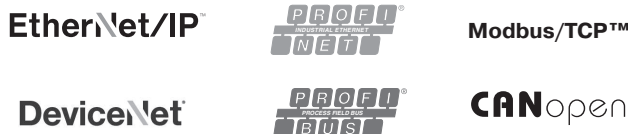

For inventory, lead times, and kit lookup, visit www.pdnplu.com

D155

Parker Hannifin Corporation
Pneumatic Division
Richland, Michigan
www.parker.com/pneumatics

D

Subbase & Manual Valves

H Series Micro

Moduflex Series

H Series ISO

Network Connectivity

DX ISOMAX Series

Valvair II Series

System Overview - Turck Network Portal with BL Remote DeviceNet Subnet

General Product Features

- Turck Network Portal with up to 256 inputs / outputs and up to 16 or 32 solenoids per manifold
- Digital inputs / outputs, IO-Link Class A Master analog inputs / outputs, serial interface, counter modules, and RFID modules available
- Connectivity to H Series Micro and H Series ISO valves

BL Remote DeviceNet Subnet Features

- With BL remote DeviceNet subnet functionality, each communication module has its own DeviceNet master which provides a connection for 63 DeviceNet nodes with additional inputs, outputs, and solenoid control
- BL remote DeviceNet subnet is independent of the main network, and is not visible to the master PLC
- P2M DeviceNet modules can be attached to the subnet to provide a connection for 16 solenoids each
- Turck DeviceNet modules can be attached to the subnet to provide a connection for 16 or 32 solenoids each and inputs and outputs up to the 256 input and output limitation

System Advantages

- Handle all I/O from one node; eliminate PLC input / output cards
- Optimized for PLC's with network capability
- Many DeviceNet nodes can be attached to the network – valve manifolds, inputs, outputs or other devices
- Eliminates junction boxes, terminal strips, and conduit runs for all inputs and outputs, greatly reducing wiring time

D	Subbase & Manual Valves
	H Series Micro
Modulflex Series	H Series ISO
	Network Connectivity
DX ISOMAX Series	Valvair II Series

Centralized Application

Valves Inside Control Cabinet

- Valves located near machine control
- Applications with caustic wash down, hazardous areas or extreme temperatures

Advantages

- Highest degree of environmental protection
- One location for all control devices
- Small size requires minimal cabinet space

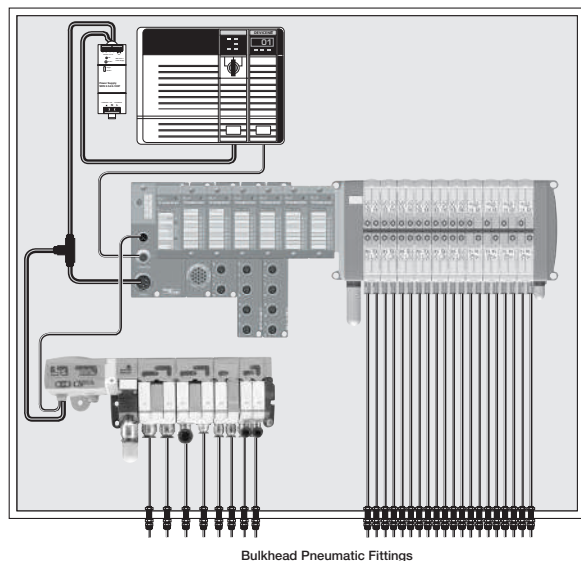

De-centralized Application

Valves Outside Control Cabinet

- Valves located near application - ready for machine mounting
- IP65 rating suitable for dusty and wet environments

Advantages

- Smallest control cabinet
- Reduces tubing length and improves response time
- Eliminates pneumatic bulk fittings on control cabinet

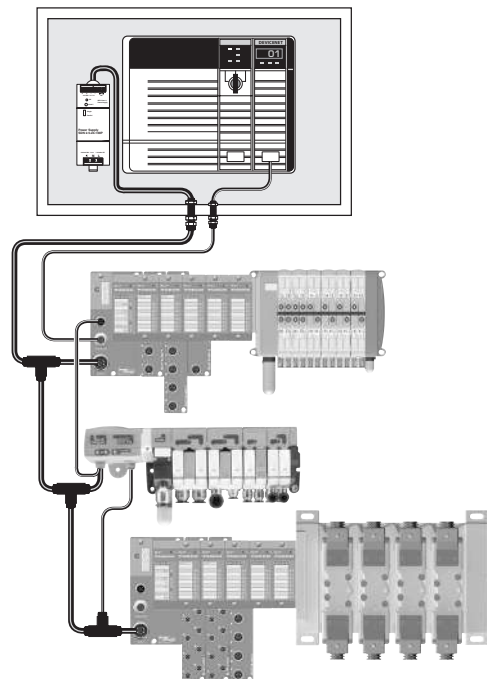

For inventory, lead times, and kit lookup, visit www.pdnplu.com

System Overview - Turck Network Portal with Stand Alone Control using CoDeSys

General Product Features

- Turck Network Portal with up to 256 inputs / outputs and 32 solenoids per manifold
- Digital inputs / outputs, analog inputs / outputs, serial interface, counter modules, and RFID modules available
- Connectivity to H Series Micro and H Series ISO valves

Stand Alone Control Features

- Communication modules equipped with standalone control – programmed according to IEC61131-3 with CoDeSys
- 512KB program memory with 32 bit RISC processor
- Run 1000 instructions in less than 1 ms
- Optimized for PLC’s with network capability or standalone controllers that need to interface with other devices

System Advantages

- Handle all I/O and control with one system; eliminate the PLC when used as the main controller for smaller machines
- Reduces programming and bandwidth requirements on large machines with a master PLC controller by handling local I/O and interfacing with the PLC over the network
- Eliminates junction boxes, terminal strips, and conduit runs for all inputs and outputs, greatly reducing wiring time

Centralized Application Valves

Inside Control Cabinet

- Valves attached to the machine control
- Applications with caustic wash down, hazardous areas, or extreme temperatures

Advantages

- Highest degree of environmental protection
- One location for all control devices

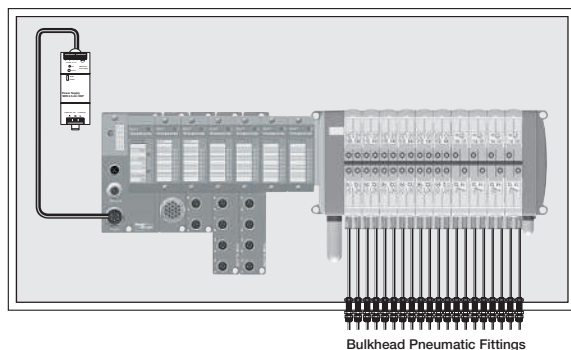

De-centralized Application

Valves Outside Control Cabinet

- Valves and machine control located near application - ready for machine mounting
- IP65 rating suitable for dusty and wet environments

Advantages

- No control cabinet needed when used as the main controller
- Reduces tubing length and improves response time
- Eliminates pneumatic bulk fittings on control cabinet

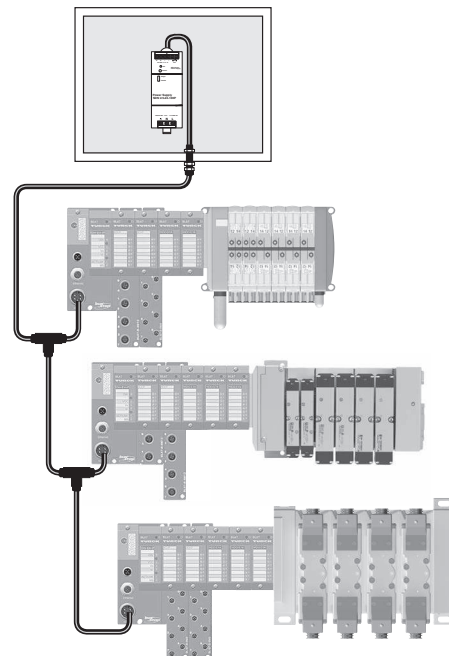

D

Subbase & Manual
Valves

H Series
Micro

Modulflex
Series

H Series
ISO

Network
Connectivity

DX ISOMAX
Series

Valvair II
Series



For inventory, lead times, and kit
lookup, visit www.pdnplu.com

D158

Parker Hannifin Corporation
Pneumatic Division
Richland, Michigan
www.parker.com/pneumatics

P2M Network Nodes

P2M communication modules directly attach to the Moduflex valve series as well as the P2M endplates of the H Series Micro. It offers a compact and low cost network solution.

Features

- Small, compact product design
- IO-Link Class A & Class B nodes
- Ethernet Communications
 - EtherNet/IP™
 - Profinet
 - EtherCat
 - Powerlink
 - ModbusTCP
- Channel-level diagnostics (LED and Electronic)
- Horizontal and vertical mounting without derating
- 5g vibration
- Quick-disconnects for I/O and network connectivity
- Built-in panel grounding
- CE certification



D

Subbase & Manual Valves

H Series Micro

Moduflex Series

H Series ISO

Network Connectivity

DX ISOMAX Series

Valvair II Series



For inventory, lead times, and kit lookup, visit www.pdnplu.com

D159

Parker Hannifin Corporation
Pneumatic Division
Richland, Michigan
www.parker.com/pneumatics

P2M Network Nodes

P2M communication module attaches directly to the end plate. It offers a compact and low cost network solution.

Features

- Small, compact product design
- IO-Link Class A & Class B nodes
- Broad protocol offering
- Built-in panel grounding
- CE certification

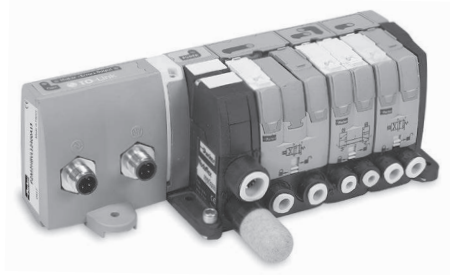

P2M2HBVL12400A13
(Class A IO-Link)

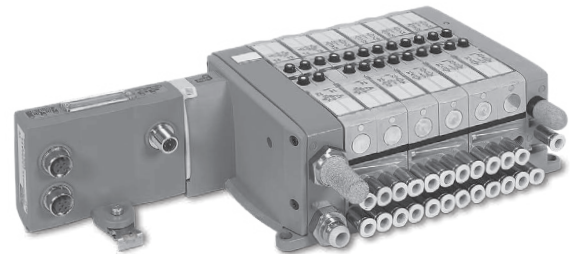

P2M2HBVE12400
(EtherNet/IP™)



D

Subbase & Manual Valves

	Industrial Ethernet Protocol	Maximum Addresses †	Part Number
	EtherNet/IP™ (Safe Power Capable)	24 †	P2M2HBVE12400
	PROFINET (Safe Power Capable)	24 †	P2M2HBVN12400
	EtherCAT (Safe Power Capable)	24 †	P2M2HBVT12400
	Modbus/TCP (Safe Power Capable)	24 †	P2M2HBVM12400
	PowerLink (Safe Power Capable)	24 †	P2M2HBVW12400

H Series Micro



Modulflex Series

H Series ISO

Network Connectivity

DX ISOMAX Series

Valvair II Series

	IO-Link Class		Aux. Power	Aux. Power Pinout	Maximum Addresses †	Part Number	
						Standard	Safe Power Capable *
	Class A	3 Pins	3 Pins	1 & 3	24 †	P2M2HBVL12400A13	P2M2HBVL12400A13-SPC
		3 Pins	3 Pins	4 & 3	24 †	P2M2HBVL12400A43	P2M2HBVL12400A43-SPC
		3 Pins	5 Pins	4 & 2	24 †	P2M2HBVL12400A42	P2M2HBVL12400A42-SPC
	Class B	5 Pins		2 & 5	24 †	P2M2HBVL12400B25	P2M2HBVL12400B25-SPC

* Safe Power Capable (-SPC) version is suitable for connection to an OSSD (test pulsed) SAFE output source.

† If using with Modulflex valves, maximum solenoid addresses limit is 19.

Further details: www.parker.com/pdn/P2M_IOL

 Most popular.



For inventory, lead times, and kit lookup, visit www.pdnplu.com

D160

Parker Hannifin Corporation
Pneumatic Division
Richland, Michigan
www.parker.com/pneumatics

P2M Industrial Ethernet Node

The P2M Industrial Ethernet 24 DO node allows a very simple and cost efficient connection to the most popular Industrial Ethernet networks.

Designed with isolated auxiliary power, it can easily be adapted to all power supply architectures and follow any required machine directives as Safe Power Capable.



Simple Product Set-Up

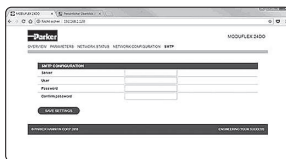

The P2M Industrial Ethernet Node offers IP addressing through 3 rotary switches located on the top side.

The 3 rotary switches also allow for Factory Reset, IP address storage, and DHCP addressing.

If supported by the protocol used, the IP address can be modified through the embedded web page.

For an application requiring a regular disconnection / reconnection of communication & power, Profinet and EtherNet/IP™ protocols allow respectively a Fast Start-Up (FSU) and Quick Connect mode. This mode can be enabled or disabled.

Topology / Integrated Ethernet Switch



The P2M Industrial Ethernet 24 DO Node offers 2 Ethernet ports allowing a line topology without external switch. The Ring topology can also be supported (enable/disable) for Profinet, EtherNet/IP™ and Modbus TCP/IP.

The integrated Ethernet switch supports Class C services allowing use in an isochronous real time (IRT) structure.

Easy Diagnostics – Local LEDs, Process (cyclic) data, Parameter (acyclic) data

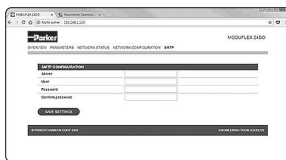

The P2M Industrial Ethernet 24 DO Node offers local diagnostics through 7 LED's located on the visible top side, showing:

- Logic status
- Ethernet activity on both ports
- Standard status due to protocol
- Output error / Auxiliary power

This local information as well as configuration and predictive maintenance diagnostics (Power monitoring, Solenoid cycle counting, etc) are available via both Process Data (cyclic) and Parameter Data (acyclic) via the PLC through the network and also easily viewable from the embedded web page.

When the PLC is NOT in control, the web page allows the user to force ON/OFF the solenoids state. This function has password protection.

Safe Power Capable

Auxiliary power of P2M Industrial Ethernet 24 DO Node can be supplied from a safe output device following machinery directives. This includes:

- Output Signal Switch Device (OSSD) test pulse compatible
- Galvanic isolation between 0 VDC Logic and Auxiliary power
- PP or PM cabling modes

For more details, refer to the user manuals located at www.parker.com/pdn/P2M_IE

D	Subbase & Manual Valves
	H Series Micro
Modulflex Series	
H Series ISO	
Network Connectivity	
DX ISOMAX Series	
Valvair II Series	



For inventory, lead times, and kit lookup, visit www.pdnplu.com

P2M Industrial Ethernet Connections & Configuration

Ethernet ports and Auxiliary power connection

Ethernet ports: 2 x Standard Female M12 D-Coded – 5 pins
 Auxiliary Power: Standard Male M12 A-Coded – 4 pins

Configuration file

The configuration files (.EDS, .GDS, etc) can be download from the product web page.

Add on Instructions & Function Blocks

Add on Instructions & Function Blocks to assist in the configuration and programming of the P2M Node are available on the product web page – www.parker.com/pdn/P2M_IE

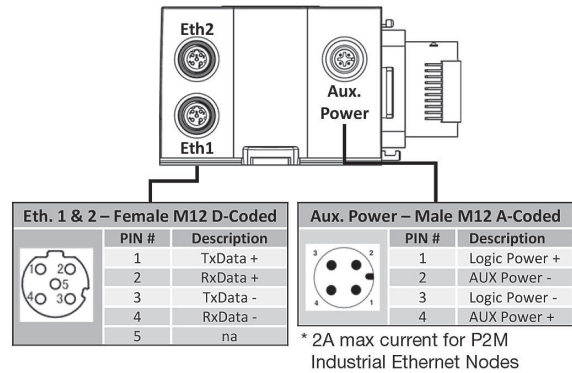

IP Address Setting

Can be done via Rotary Switches, DHCP, Web page, Ipconfig Tool or TCP/IP Interface Object, depending on protocol:

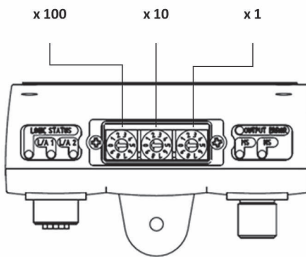

Description	EtherNet/IP™ Profinet IO Modbus TCP/IP	Ethernet PowerLink	EtherCAT
IP-Address setting stored into the NV-memory of the P2M node	000	000	N/A
IP-Address setting determined by the 3 rotary switches:			
• IP Address: 192.168.1.xxx	001 – 254	001 – 239	N/A
• Subnet Mask: 255.255.255.0			
• Default Gateway for 001: 192.168.1.2			
• Default Gateway for 002 - 254: 192.168.1.1			
The device will obtains its address via DHCP	888	N/A	N/A
Reset to factory status	999	999	999
Invalid, the module will not start	All others	All others	All others

P2M Industrial Ethernet Valve Control

All P2M Industrial Ethernet Modules can easily connect to and control pneumatic valves sizes ranging from 0.18 Cv to 6.0 Cv utilizing the Moduflex, H Micro, or H ISO valve series including the new H ISO Universal manifold which can mix ISO sizes 15407 (sizes 02 & 01) and 5599 (sizes 1 & 2) without transition plates.

P2M on Moduflex



P2M on H Series Micro

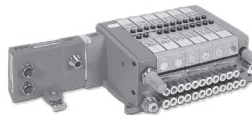

P2M Industrial Ethernet Node Output (Solenoid) data mapping - shown on Moduflex valve series

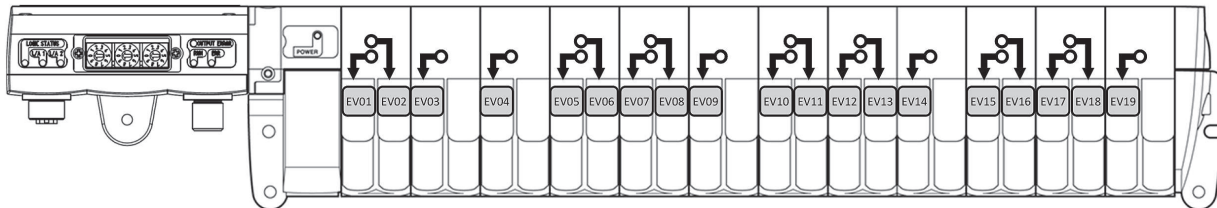

	7 3	2 0
Byte 0	EV08 EV01	
Byte 1	EV16 EV09	
Byte 2*	EV24 EV20	EV19 EV17

* Byte 2 / Bits 3 to 7 are only available when connected to H Series Micro or H Series ISO valve manifolds. The Moduflex valve series is limited to 19.

Process (Cyclic) Diagnostic through network via ADI #9 – “Module Error Input”

Easy to access diagnostic data transmitted to the PLC as Application Device Instance (ADI) #9

- Voltage warning, short circuit condition, module error, etc
- For more details refer to user manual on product web page – www.parker.com/pdn/P2M_IE

ADI	Instance Name	Data Type	Access
#9	Module error input	Unit 16	Read
Byte 0	Diag 7	Diag 0	
Byte 1	Reserved		



For inventory, lead times, and kit lookup, visit www.pdnplu.com

D
 Subbase & Manual Valves
 H Series Micro
 Moduflex Series
 H Series ISO
 Network Connectivity
 DX ISOMAX Series
 Valvaire II Series

Valve Island V Series with Industrial Ethernet connection

The P2M Industrial Ethernet Lite node 24DO allows a very simple and cost efficient connection to the most popular Industrial Ethernet networks.

In its compact IP40 version equipped with two RJ45 Ethernet ports, it saves size in cabinet applications and offers an easy connection to the network in a line topology.

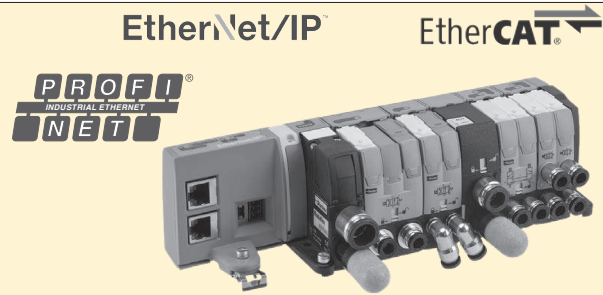

Industrial Ethernet Protocol	Part Number
Profinet IO	P2M2HBVE12400RJ
EtherNet/IP™	P2M2HBVN12400RJ
EtherCAT	P2M2HBVT12400RJ

Product Set-Up



The P2M Lite Node 24DO is by default in DHCP mode. The module must be assigned to a static IP-Address in order to be controlled via the network.

The Network Configuration settings can be done through the embedded web server of the node as well as "IPconfig", "TIA Portal" or similar methods.

For an application requiring a regular disconnection / reconnection of the node, Profinet and EtherNet/IP™ protocols allow respectively a Fast Start- Up (FSU) and Quick Connect mode. This mode can be enable or disable .

Technology / Integrated Ethernet Switch



The P2M Industrial Ethernet Lite node 24DO offers 2 RJ45 ports allowing a line topology without external switch. The Ring topology can also be supported (enable/disable) for Profinet and EtherNet/IP™.

The integrated Ethernet switch support Class C Services allowing used in an isochronous real time (IRT) structure.

Diagnostic



The P2M Industrial Ethernet Lite node 24DO offers a local diagnostic through 5 LED's located on the visible top side and 4 additional on both Ethernet connectors showing:

- Logic status
- Ethernet activity on both ports
- Standard Status due to protocol
- Output error / Power Supply

This local information as well as trouble shooting and predictive maintenance diagnostics (Power monitoring, Life cycle counting, ...) are available in PLC through the network and reported on imbedded web page.

When PLC is in "STOP", the web page allows to force ON/OFF solenoids state. This function has a password protection.

Save 1.31 inches with P2M Lite Node compared to P2M Ethernet Node

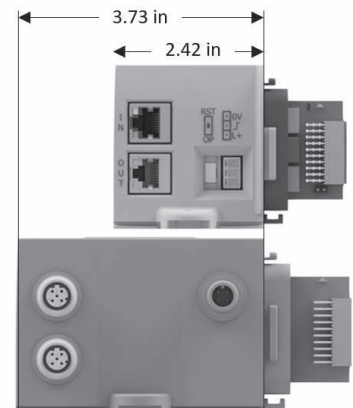

Industrial Ethernet Lite Node Connections and Diagnostic Functions

Ethernet and Power Connections

Network Communication Ports:

2 x Standard RJ45 Female connectors

Usage of standard manufactured cables available from your usual electrical supplier is recommended.

Power Supply:

Standard 3-Pin Male Connector - 3,81 mm pitch

Working mode selector:

DIP-switch

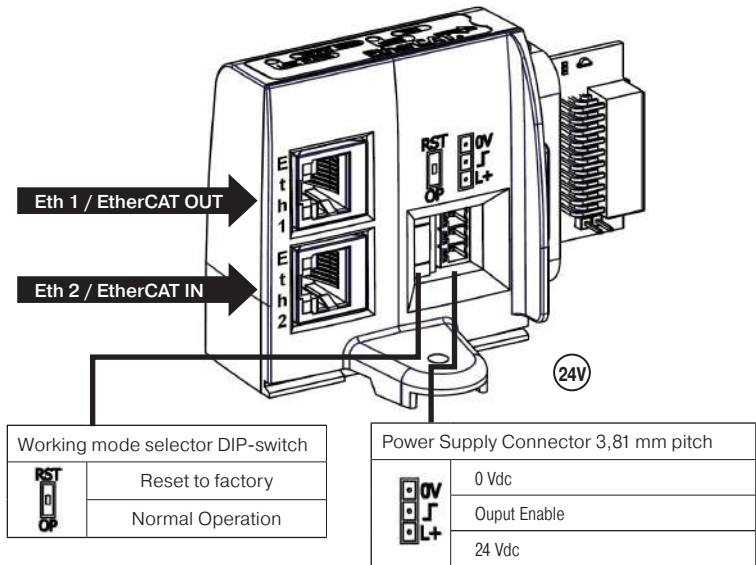

Configuration Files

The configuration files can be download from the product web page: www.parker.com/pde/P2M_IE

IP Address Setting

For both Profinet IO and EtherNet/IP™ protocols, the P2M Lite 24DO Node is by default in DHCP mode. The module must be assigned to a static IP-Address in order to be controlled via network. Please, refer to the user manual for IP-Address assignment process.

Local and Network Diagnostic Functions

Local Diagnostic

The P2M Lite 24DO node offers a local diagnostic via 9 LED's. Please refer to user manual with interpretation table.

Network Diagnostic

The P2M Lite 24DO Node offers additional useful module status information:

- Pilot overload or short circuit
- Power Voltage out of tolerance
- Cycle counter for every pilot
- Module temperature

For detailed technical information on the P2M Lite 24DO Node and a complete interpretation of node's diagnostic functionalities, please refer to the User Manual available from the product web page: www.parker.com/pde/P2M_IE

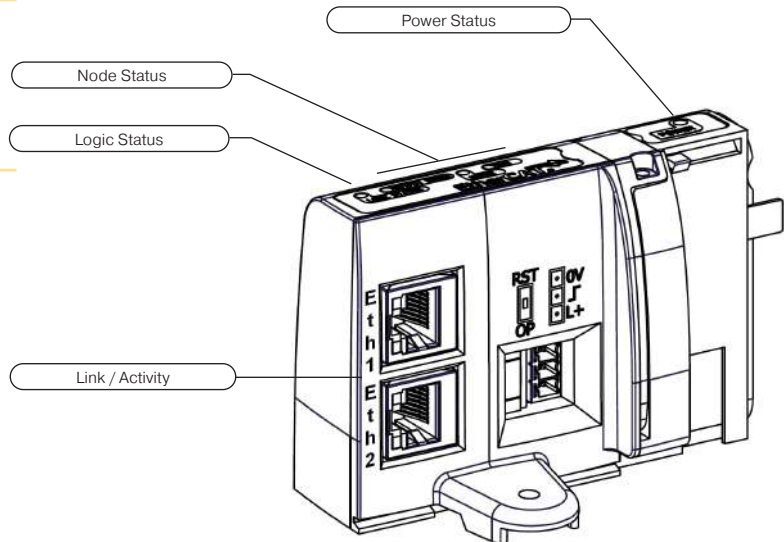

EtherNet/IP™



EtherCAT®

D
 Subbase & Manual Valves
 H Series Micro
 Modulflex Series
 H Series ISO
 Network Connectivity
 DX ISOMAX Series
 Valvair II Series



For inventory, lead times, and kit lookup, visit www.pdnplu.com

Valve Island V Series with IO-Link connection

The P2M Moduflex IO-Link 24 DO node allows a very simple and cost efficient connection to any IO-Link master, centralised into the PLC or decentralised through an industrial Ethernet network.

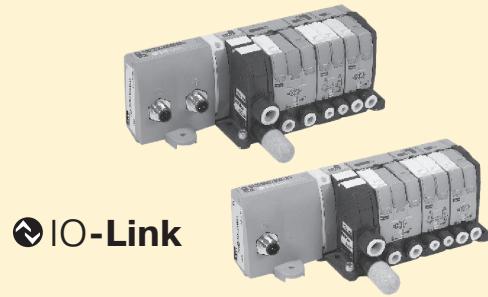

Designed in both Class A and Class B versions with an isolated auxiliary power, it can easily be adapted to all power supply architectures and follow machine directives.



“V” Series Valve Island - P2M head module for IO-Link

Electrical Module for 24 outputs
 (The last 5 outputs of this 24 DO module can not be used with Moduflex Valve)

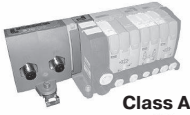

		M12 A Coded Connector Connection					Part Number	
	Description	IO-Link Class	IO-Link	Aux. Power	Aux. Power Pinout	Weight (g)	Standard	Safe Power Capable
 Class A	P2M IO-Link communication module	Class A	3 Pin's	3 Pin's	1 & 3	160	P2M2HBVL12400A13	P2M2HBVL12400A13-SPC
			3 Pin's	3 Pin's	4 & 3	160	P2M2HBVL12400A43	P2M2HBVL12400A43-SPC
			3 Pin's	5 Pin's	4 & 2	160	P2M2HBVL12400A42	P2M2HBVL12400A42-SPC
 Class B		Class B	5 Pin's		2 & 5	140	P2M2HBVL12400B25	P2M2HBVL12400B25-SPC
Power & communication cable							RKC 4.5T-* -RSC 4.5T/S1587	

IODD file can be downloaded from IODD Finder or the Moduflex web site:
<https://ioddfinder.io-link.com> or www.parker.com/pdn/io-link

Where * = 1, 2, 3, 4, 5, 10, 20 meter standard lengths

P2M Class A Module with Independent Auxiliary Power Supply

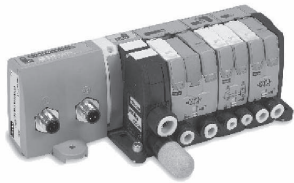

The P2M IO-Link Class A module can handle a Moduflex valve manifold having up to 19 solenoid outputs, or H Series Micro / ISO up to 24 solenoid outputs.

Thanks to its 2 x M12 A coded male connectors, the P2M node can be connected to any IO-Link Class A master and separately receive its auxiliary power supply for valves from an independent source.

The P2M IO-Link Class A module exists in 3 versions with the auxiliary power M12 connector pin out adapted to any sourcing through a standard M12 cable:

- P2M2HBVL12400A13 version: 24VDC / 0VDC on pins 1 & 3 – Standard version
- P2M2HBVL12400A43 version: 24VDC / 0VDC on pins 4 & 3 – Compatible with Siemens wiring
- P2M2HBVL12400A42 version: 24VDC / 0VDC on pins 4 & 2 – Compatible with Rockwell wiring and Turck wiring

P2M Class B Module

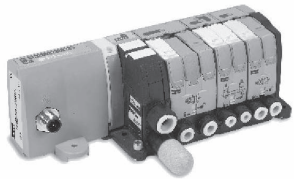

The P2M IO-Link Class B module can handle a Moduflex valve manifold having up to 19 solenoid outputs, or H Series Micro / ISO up to 24 solenoid outputs.

Thanks to its single M12 A coded male connectors, P2M node can be connected to any IO-Link Class B master receiving its auxiliary power supply for valves on pins 2 & 5 from the only cable simplifying the connection.

- P2M2HBVL12400B25 version: 24VDC / 0VDC on pins 2 & 5

Valve Series

Check the total maximum solenoid current consumption against the limit of the power supply and P2M module (standard version 4A, SPC version 2A).



Moduflex Valve
 Cv: .18 - 0.80
 19 Solenoids
 42mA per Sol.

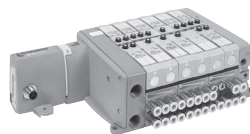

H Micro
 Cv: 0.35
 24 Solenoids
 42mA per Sol.



For inventory, lead times, and kit lookup, visit www.pdnplu.com

D165

Parker Hannifin Corporation
 Pneumatic Division
 Richland, Michigan
www.parker.com/pneumatics

D

Subbase & Manual Valves

H Series Micro

Moduflex Series

H Series ISO

Network Connectivity

DX ISOMAX Series

Valvair II Series

IO-Link Module Connection and Diagnostic Functions



IO-Link Module Connection

Standard male M12 – type A
 Usage of standard manufactured cables available from your usual electrical supplier is recommended.

Note: Auxiliary power for solenoids can be wired allowing the user to turn outputs off while the communications remains on.

Configuration

IODD file can be downloaded from IODD Finder or the P2M web site:

<https://ioddfinder.io-link.com>

www.parker.com/pdn/P2M_IOL

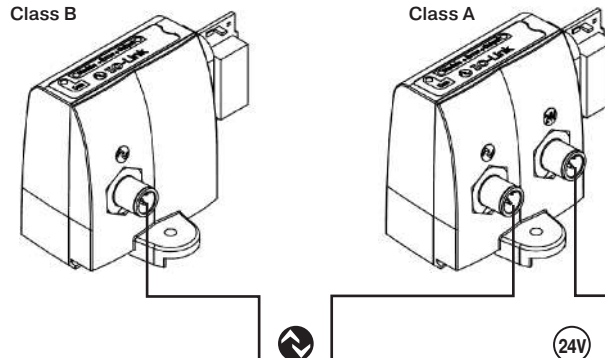

Legend

Symbol	Description
L+	IO-Link power supply "+"
L-	IO-Link power supply "-"
C/Q	IO-Link communication
Aux +	Auxiliary power supply 24 VDC
Aux -	Auxiliary power supply 0 VDC

M12 pin's	Class A		
	3 pin's	5 pin's	5 pin's
	P2M...A13	P2M...A43	P2M...A42
1	Aux +	Not used	Not used
2	-	-	Aux -
3	Aux -	Aux -	Not used
4	n.c.	Aux +	Aux +
5	-	-	Not used

Auxiliary Power Supply Compatibility

The P2M IO-Link Node can be powered from a 24VDC auxiliary source in PP or PM mode as grounds are isolated.

The P2M Safe Power Capable (-SPC) versions can be connected from a SAFE OSSD test pulsed power source.

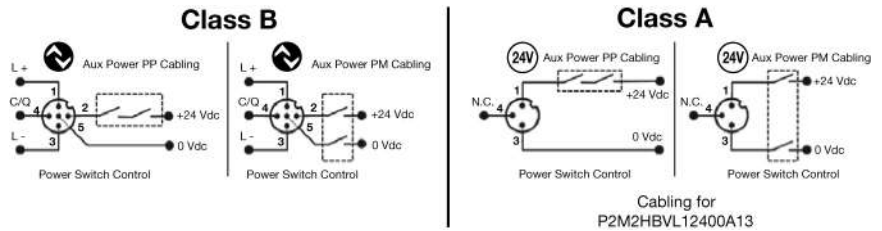

IO-Link Module Diagnostic Functions

The P2M IO-Link module offers additional useful module status information:

- Solenoid overload or short circuit
- Auxiliary voltage out of tolerance
- Cycle counter for each solenoid
- Module temperature

For more information on product technical information and module diagnostic functionalities, please refer to the user manual available from the product web page:
www.parker.com/pdn/P2M_IOL

COM Green LED			Module-Error Red LED			Error-Output Red LED			POWER Green LED		
LED Status	Description	Solving	LED Status	Description	Solving	LED Status	Description	Solving	LED Status	Description	Solving
OFF	IO-Link L+ / L- not powered	Check connection	OFF	Standard mode	NA	OFF	Standard mode	NA	OFF	AUX power failure	Check Auxiliary Power Supply
ON	IO L+ / L- powered IO mode	Set IO-Link mode in IO-Link master	ON	24 VDC AUX power missing or any active malfunction	Check power supply or change module	ON	Any driver error (overload, over temperature, etc.)	Fix solenoid issue then acknowledge error	ON	Standard	NA
Blinking	IO-Link communication active	NA							Blinking	Aux Power is out of range, alarm level	Check Auxiliary Power Supply

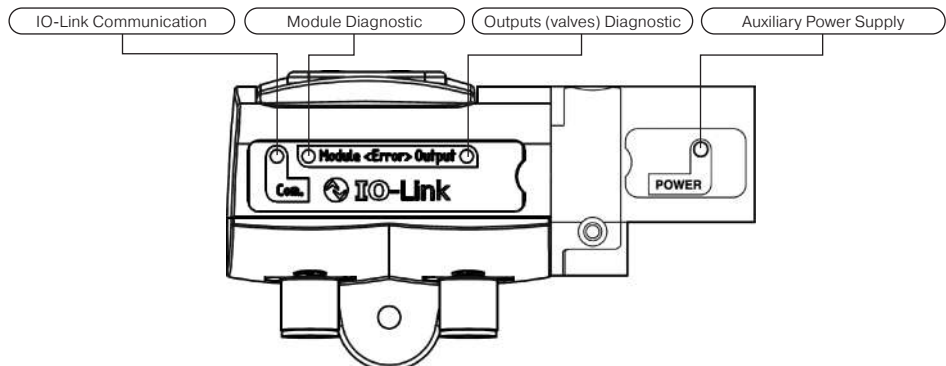

D Subbase & Manual Valves
 H Series Micro
 Modulflex Series
 H Series ISO
 Network Connectivity
 DX ISOMAX Series
 Valvaire II Series



For inventory, lead times, and kit lookup, visit www.pdnplu.com

Input Data

One byte of diagnostic input data is transferred from P2M IO-Link to the IO-Link Master.

Process Input Data

7	6	5	4	3	2	1	0
Output driver SPI error	Output driver channel error	Polyfuse tripped	Temperature warning	SPI error	AUX voltage error	AUX voltage warning	Acknowledge Required

Output Data

Three bytes of process data are received by P2M IO-Link from the IO-Link Master for control of solenoids.

Process Output Data (Byte 0)

7	6	5	4	3	2	1	0
EV8	EV7	EV6	EV5	EV4	EV3	EV2	EV1

Process Output Data (Byte 1)

7	6	5	4	3	2	1	0
EV16	EV15	EV14	EV13	EV12	EV11	EV10	EV9

Process Output Data (Byte 2)

7	6	5	4	3	2	1	0
EV24	EV23	EV22	EV21	EV20	EV19	EV18	EV17

Solenoid Pilots Addressing and Process Mapping

P2M IO-Link node addressing used with Moduflex Valve System

The P2M IO-Link node, when used with Moduflex Valve System can handle up to 19 pilot solenoid valves. Addressing will be done as shown below.

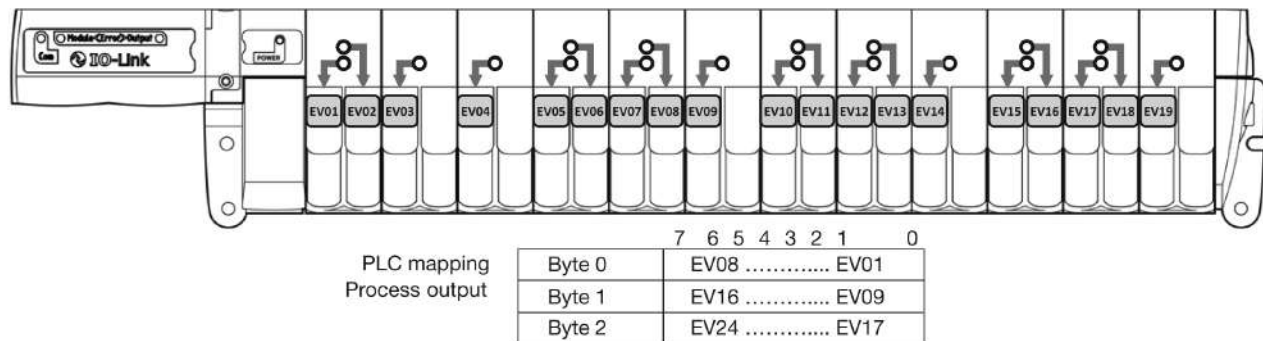

P2M IO-Link Module Electrical Specifications

IO-Link power supply	According to IO-Link standard V1.1.2
Speed communication	Com 2 - 38 kBd
Auxiliary power supply	20.4 VDC to 26.4 VDC
Current limit per channel	150 mA
Max current limit	4 A
Polarity inversion	YES
Short circuit protection	YES
Operating temperature	0°C to 55°C
Storage temperature	-25°C to 70°C
Shock according to IEC	60068-2-27:2008
Vibration according to IEC	60068-2-6:2007
EMC according to IEC	61000-4-2 up to -4-6

Network Diagnostic Through Process Mapping:

The P2M IO-Link module offers diagnostic data transmitted to the PLC through the master:

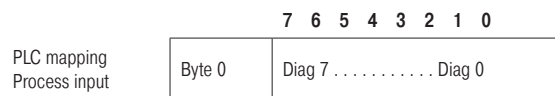

Diag bit Error message Detail

- Diag 0 Fail-safe status Acknowledgement required
- Diag 1 Auxiliary voltage warning Check auxiliary power
- Diag 2 Auxiliary voltage failure Check auxiliary power
- Diag 3 Module failure Module HS. must be replaced
- Diag 4 Module over-temperature
- Diag 5 Module over-load
- Diag 6 Pilot solenoid(s) short circuit .. Solenoid must be replaced
- Diag 7 Outputs stage failure

For further details, refer to the user manual: can be downloaded from www.parker.com/pdn/P2M_IOL



For inventory, lead times, and kit lookup, visit www.pdnplu.com

Solenoid Pilot Diagnostic Common to All P2M Nodes

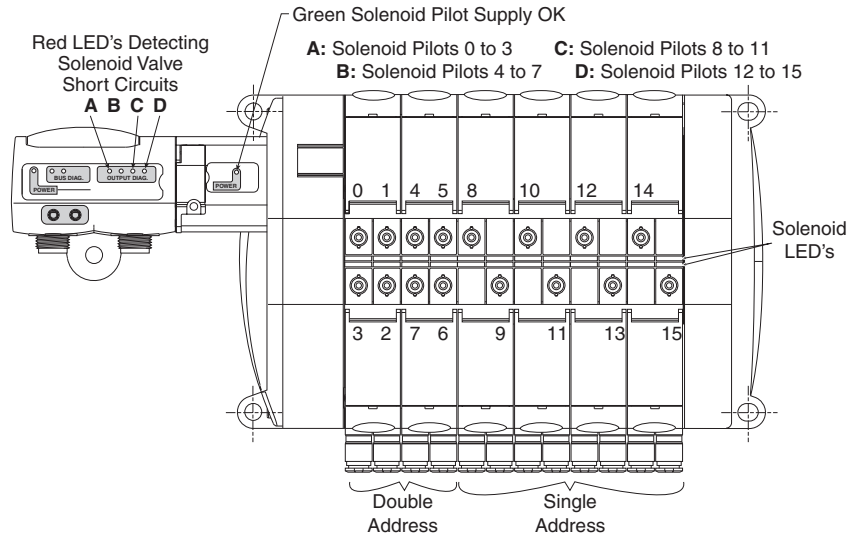

Inside the communication module, solenoid valve control is protected against short-circuits with the following visual indication provided:

- The red LEDs with code, shown above, detect solenoid valve short-circuits
- Supply is OK when the solenoid pilot power supply indicator is green

D

Subbase & Manual
 Valves

H Series
 Micro

Modulflex
 Series

H Series
 ISO

Network
 Connectivity

DX ISOMAX
 Series

Valvair II
 Series



For inventory, lead times, and kit lookup, visit www.pdnplu.com

D168

Parker Hannifin Corporation
 Pneumatic Division
 Richland, Michigan
www.parker.com/pneumatics

P2H IO-Link Node 24 DO

The P2H Network Node is available with IO-Link connectivity for the industries first connection of ISO valves (5599 & 15407) to the low cost IO-Link network.

Features

- Compact, robust product design
- Weld splatter resistant housing material
- Simple connection to IO-Link Class A or Class B masters
- Industries first power in & out capability for Class A version
- Industries first 7/8" power connectors on Class A version
- IO-Link connection to new H Series ISO Universal Manifold, capable of mixing valve sizes from 0.5 Cv – 3 Cv
- Safe Power Capable for supplying valve power from a safety device (i.e., safe relay)
- Diagnostics made SIMPLE! Useful diagnostic flags in process (cyclic) data for easy access and use for preventative maintenance
- Certified to IP65 ingress protection
- CE certification

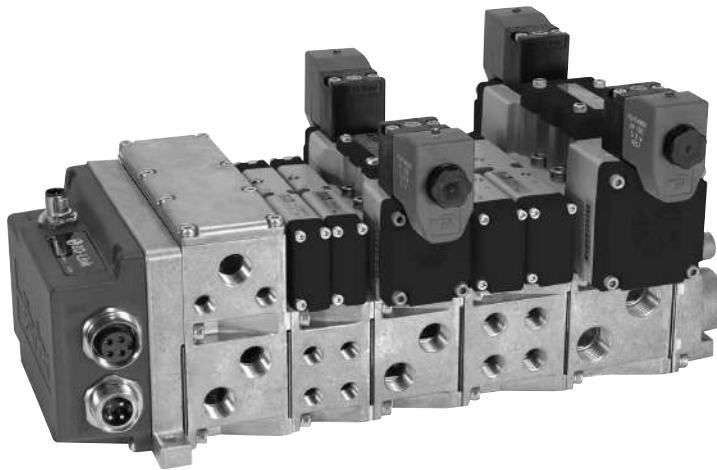

Class A Node

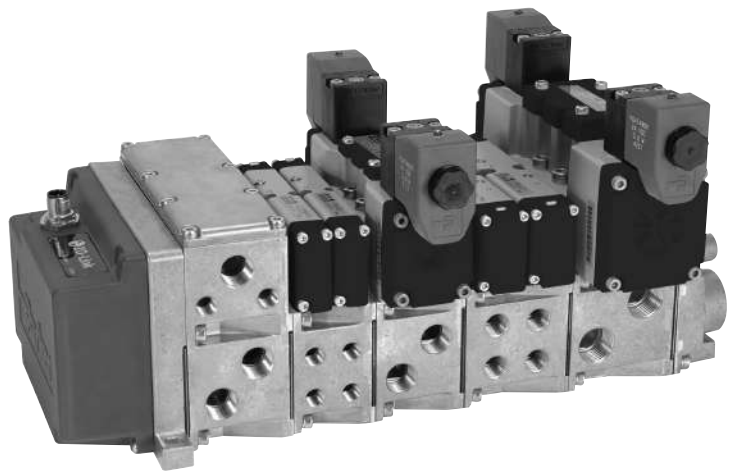

Class B Node

D

Subbase & Manual Valves

H Series Micro

Modulflex Series

H Series ISO

Network Connectivity

DX ISOMAX Series

Valvair II Series



For inventory, lead times, and kit lookup, visit www.pdnplu.com

D169

Parker Hannifin Corporation
Pneumatic Division
Richland, Michigan
www.parker.com/pneumatics

Overview - P2H IO-Link Node 24 DO

Designed to integrate directly with all H Series ISO valve sizes, the P2H IO-Link Network Node provides a compact, robust and cost efficient solution for IO-Link capability. The P2H IO-Link network node is offered as an end plate kit on the H Series valve for five sizes (HB, HA, H1, H2 and H3). The P2H node is suitable for use on a valve manifold with up to 24 solenoid outputs.

Connection Types and Power:

Class A Node

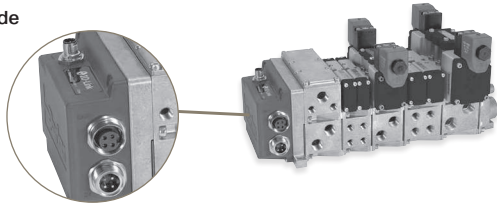

The Class A node has (1) 3 pin M12 connector for communication and logic power from any class A IO-Link master, and (2) 7/8" connectors for auxiliary valve power IN and OUT.

Class B Node

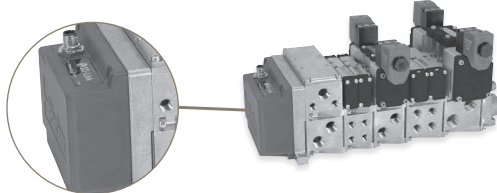

The Class B node has (1) 5 pin M12 connector to connect IO-Link for communication to a Class B IO-Link master, logic power and auxiliary power for the valve solenoids (up to the limit of the Class B node output*).

*It is recommended to use the Class A node with auxiliary power if the Class B master cannot provide enough power.

Left and Right Hand End Plate

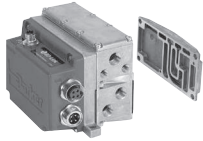
	IO-Link Class / Type	Current	HB, HA, H1, H2 Valves		H3 Valves	
			NPT Port	BSPP Port	NPT Port	BSPP Port
 Class B	P2H IO-Link Class B, standard version, 24 address	3.2A max	PSHU20N200P	PSHU20N201P	PS4220N20DP	PS4220N21DP
	P2H IO-Link Class B, Safe Power Capable, 24 address	2.0A max	PSHU20S200P	PSHU20S201P	PS4220S20DP	PS4220S21DP
 Class A	P2H IO-Link Class A, 4-pin Safe Power Capable, 24 address	3.2A max	PSHU20S400P	PSHU20S401P	PS4220S40DP	PS4220S41DP
	P2H IO-Link Class A, 5-pin Safe Power Capable, 24 address	3.2A max	PSHU20S500P	PSHU20S501P	PS4220S50DP	PS4220S51DP

www.parker.com/pdn/P2H_IOL

Description	Standard version	- Safe power capable versions
IO-Link power supply	According to IO-Link standard V1.1.2	
Speed communication	Com 2 – 38 kBd	
Auxiliary power supply	voltage	20,4 VDC to 26,4 VDC
OSSD compatibility	No	Yes
Short circuit protection	Yes	
Operating temperature	0°C to +55°C	
Shock	According to IEC 60068-2-27:2008	
Vibration	According to IEC 60068-2-6:2007	
EMC	According to EN 55011 & EN 61000-4-2 to -4-6	
Ingress protection	Certified to IP65	

D
 Subbase & Manual Valves
 H Series Micro Series
 Modulflex Series
 H Series ISO
 Network Connectivity
 DX ISOMAX Series
 Valvair II Series



For inventory, lead times, and kit lookup, visit www.pdnplu.com

D170

Parker Hannifin Corporation
 Pneumatic Division
 Richland, Michigan
www.parker.com/pneumatics

P2H IO-Link Node 24 DO – Connections and LED Diagnostics

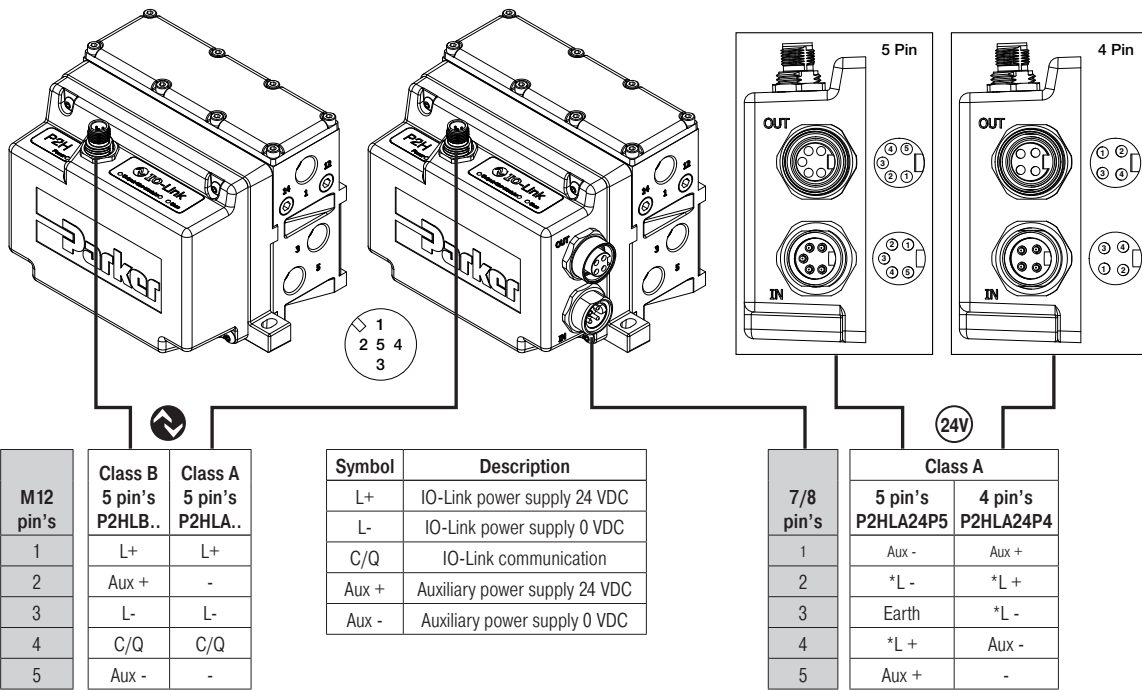

Note: * 7/8" logic power has no connection to internal P2H unit but does carryover to OUT 7/8" connector (for jumper logic power only). Logic power for P2H unit will be supplied from M12 (pin 1 & 3)

Local diagnostic through LED:

The P2H IO-Link Node offers a local diagnostic through 4 LED's status with interpretation described in the table below:

Power <input type="radio"/> Green LED			<input type="radio"/> Output<Err> Red LED			<Err>Module <input type="radio"/> Red LED			<input type="radio"/> Com Green LED		
LED Status	Description	Solving	LED Status	Description	Solving	LED Status	Description	Solving	LED Status	Description	Solving
OFF <input type="radio"/>	Auxiliary power failure < 18V or > 28.5V	Check auxiliary power supply	OFF <input type="radio"/>	Standard mode (No error active)	N/A	OFF <input type="radio"/>	Standard mode (No error active)	N/A	OFF <input type="radio"/>	IO-Link L+ / L- line not powered	Check IO-Link power supply from IO-Link Master (pin's 1 & 3)
ON <input checked="" type="radio"/>	Standard mode (auxiliary power within normal range 20.4V* to 26.4V*)	N/A	ON <input checked="" type="radio"/>	Any outputs driver error (auxiliary power error, overload, short circuit, over temperature, ...)	If auxiliary power OK (see Power LED status), check error messages and related troubleshooting	ON <input checked="" type="radio"/>	24 VDC auxiliary power missing or any active malfunction	Check Auxiliary power supply. If auxiliary power supply OK, module must be replaced	ON <input checked="" type="radio"/>	IO-Link L+ / L- line powered IO-Link master port set as SIO mode	Set IO-Link master channel in IO-Link mode
Blinking	Auxiliary power out of range (warning level*)	Check auxiliary power supply, check/reset adjusted values							Blinking	IO-Link communication active	N/A

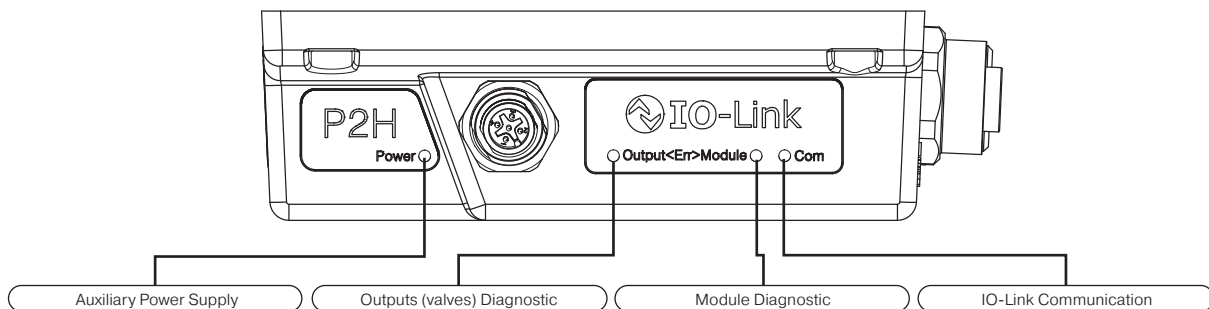

P2H IO-Link Node 24 DO – Connections and LED Diagnostics

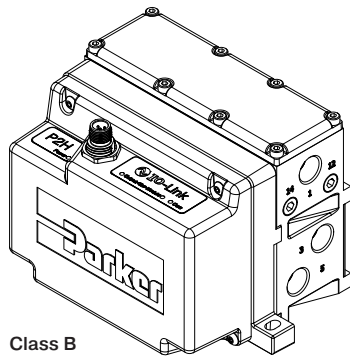

Class B

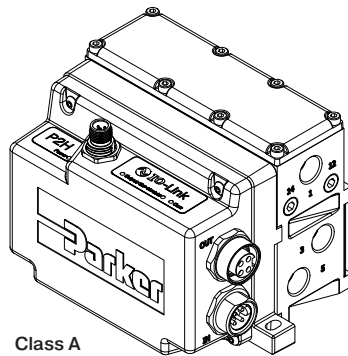

Class A

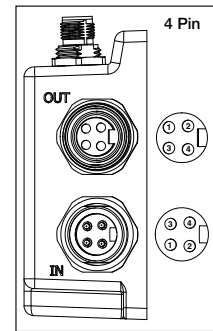
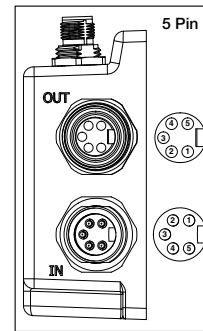

P2H IO-Link 24DO Node connection to SAFE Power PP / PM mode for valve control

The P2H IO-Link 24DO node can be powered from a SAFE 24 VDC auxiliary source in PP or PM mode as grounds are isolated. Auxiliary power for solenoids can be wired allowing the functionality to turn outputs OFF while communications remain active.

Class A – 5 Pin

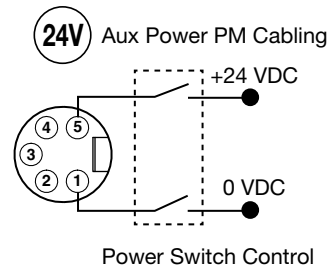
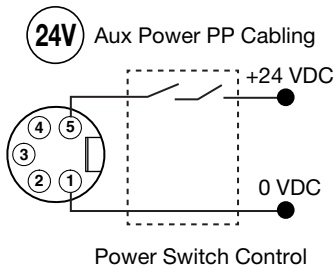

Pin Number	Address
1	AUX-
2	*L-
3	Earth
4	*L+
5	AUX+

Class A – 4 Pin

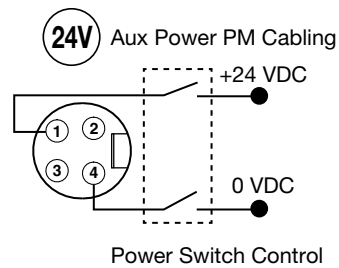
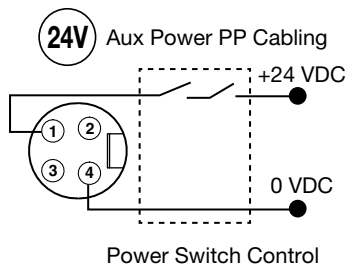

Pin Number	Address
1	AUX+
2	*L+
3	*L-
4	AUX-

Class B

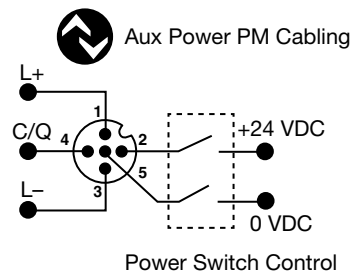
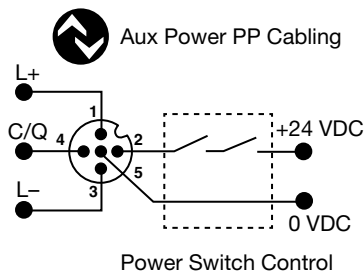

Pin Number	Address
1	L+
2	AUX+
3	L-
4	C/Q
5	AUX-

* 7/8" logic power has no connection to internal P2H unit but does carry over to OUT 7/8" connector (for jumper logic power only). Logic power for P2H unit will be supplied from M12 (pin 1 & 3).

D
 Subbase & Manual Valves
 H Series Micro
 Modulflex Series
 H Series ISO
 Network Connectivity
 DX ISOMAX Series
 Valvair II Series



For inventory, lead times, and kit lookup, visit www.pdnplu.com

P2H IO-Link Node 24 DO – Input / Output Data Mapping

Input Data

One byte of diagnostic input data is transferred from Moduflex to the IO-Link Master.

Process Input Data

7	6	5	4	3	2	1	0
Output driver SPI error	Output driver channel error	Polyfuse tripped	Temperature warning	SPI error	Aux voltage error	Aux voltage warning	Acknowledge required

Diag bit	Error Message	Detail
Diag 0	Fail-safe status	Acknowledgment required
Diag 1	Auxiliary voltage warning	Auxiliary voltage out of range, check auxiliary power line
Diag 2	Auxiliary voltage failure	Auxiliary voltage out of order, check auxiliary power source
Diag 3	Module failure	Switch OFF / ON auxiliary power, if error message persists, replace the module
Diag 4	Module over-temperature	Switch OFF / ON auxiliary power, if error message persists, replace the module
Diag 5	Module over-load	Check overall pilot solenoid valves, if error message persists, replace the module
Diag 6	Pilot solenoid(s) short circuit	Check faulty pilot solenoid valve(s), replace if necessary
Diag 7	Outputs stage not available	Auxiliary power is OFF

Output Data

Three bytes of process data are received by Moduflex from the IO-Link Master for control of solenoids.

Process Output Data (Byte 0)

7	6	5	4	3	2	1	0
EV8	EV7	EV6	EV5	EV4	EV3	EV2	EV1

Process Output Data (Byte 1)

7	6	5	4	3	2	1	0
EV16	EV15	EV14	EV13	EV12	EV11	EV10	EV9

Process Output Data (Byte 2)

7	6	5	4	3	2	1	0
EV24	EV23	EV22	EV21	EV20	EV19	EV18	EV17

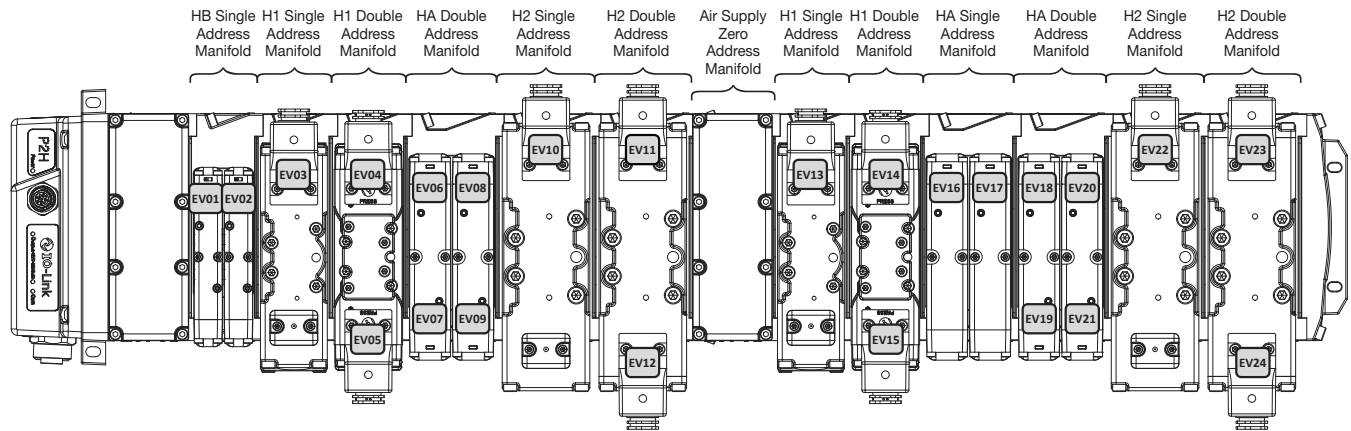

PLC Process outputs data mapping

	7	0
Byte 0	EV08	EV01
Byte 1	EV16	EV09
Byte 2	EV24	EV17

Configuration IODD File

IODD file can be downloaded from IODD Finder or the P2H IO-Link web site:

- <https://ioddfinder.io-link.com>
- www.parker.com/pdn/P2H_IOL



For inventory, lead times, and kit lookup, visit www.pdnplu.com

Features

P2H Ethernet Node 32 DO

The P2H Ethernet Node has been designed to be connected to a many popular Ethernet Networks. It can be used with Parker's H-Universal ISO 15407-2 (size 02 & 01) and 5599-2 (sizes 1, 2 & 3) valve series. It can control up to 32 pilot solenoid addresses with different power configuration options available and provides local visual and remote diagnostics through the Network. Designed for industrial environments, the P2H Ethernet Node is constructed of PBT material, which is glass-filled and offers weld splatter resistance, UV stability and has significant flame-retardant properties making it suitable for the durability required in industrial applications with high heat and welding applications.

Features

Industrial Ethernet Protocols:

- EtherNet/IP
- Profinet
- EtherCAT
- Modbus TCP
- Powerlink

Power Options:

- Power IN/OUT Connection
- 7/8 4 pin
- 7/8 5 pin
- L- Code M12 5 pin
- Safe Power Capable
- OSSD Compatible

Environment:

- IP65
- Weld Spatter Resistant
- Weld Noise Immune

Diagnostics:

- PLC
- Web Interface
- Network Specific LED's

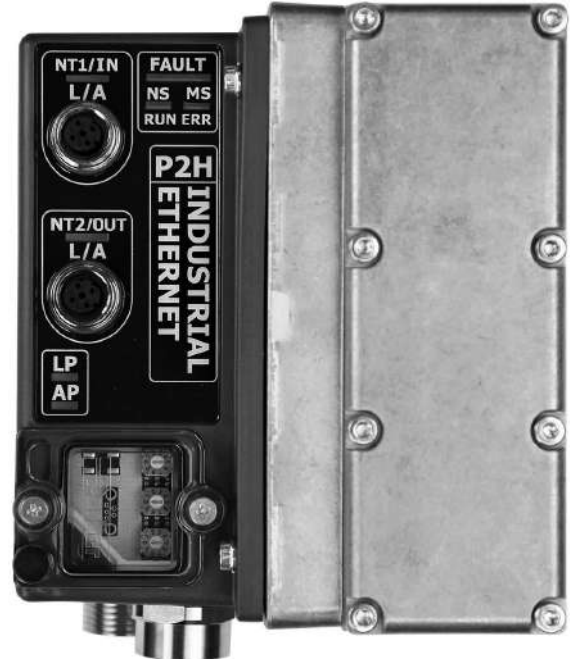
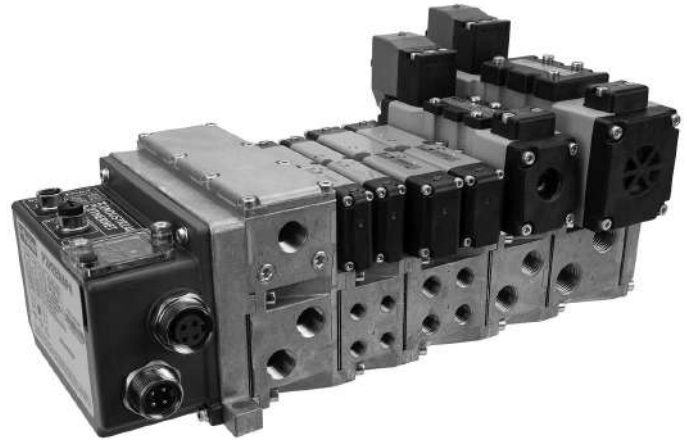

D	Subbase & Manual Valves
	H Series Micro
	Modulflex Series
	H Series ISO
	Network Connectivity
	DX ISOMAX Series
	Valvair II Series



For inventory, lead times, and kit lookup, visit www.pdnplu.com

D174

Parker Hannifin Corporation
 Pneumatic Division
 Richland, Michigan
www.parker.com/pneumatics

P2H Ethernet Node 32 DO - Popular Module Combinations

- Listed below are popular module configurations
- For full model number structure, please refer to next page

EtherNet/IP™

Popular Part Number Configurations

Pilot Type	Thread Type	Power Source for Output 25-32	Power Connector	End Plate Part Number
Internal	NPT	Aux Power	7/8" 4-pin power IN/OUT with 1 safe power capable zone	PSHU20P200PE000A-P4
Internal	NPT	Logic Power Isolated from Aux Power	7/8" 4-pin power IN/OUT with 1 safe power capable zone	PSHU20P200PE000L-P4
Internal	NPT	Aux Power	7/8" 5-pin power IN/OUT with 1 safe power capable zone	PSHU20P200PE000A-P5
Internal	NPT	Logic Power Isolated from Aux Power	7/8" 5-pin power IN/OUT with 1 safe power capable zone	PSHU20P200PE000L-P5
Internal	NPT	Aux Power	M12 L-Coded, 5-pin power IN/OUT with 1 safe power capable zone	PSHU20P200PE000A-L5
Internal	NPT	Logic Power Isolated from Aux Power	M12 L-Coded, 5-pin power IN/OUT with 1 safe power capable zone	PSHU20P200PE000L-L5



Popular Part Number Configurations

Pilot Type	Thread Type	Power Source for Output 25-32	Power Connector	End Plate Part Number
Internal	NPT	Aux Power	7/8" 4-pin power IN/OUT with 1 safe power capable zone	PSHU20P200PN000A-P4
Internal	NPT	Logic Power Isolated from Aux Power	7/8" 4-pin power IN/OUT with 1 safe power capable zone	PSHU20P200PN000L-P4
Internal	NPT	Aux Power	7/8" 5-pin power IN/OUT with 1 safe power capable zone	PSHU20P200PN000A-P5
Internal	NPT	Logic Power Isolated from Aux Power	7/8" 5-pin power IN/OUT with 1 safe power capable zone	PSHU20P200PN000L-P5
Internal	NPT	Aux Power	M12 L-Coded, 5-pin power IN/OUT with 1 safe power capable zone	PSHU20P200PN000A-L5
Internal	NPT	Logic Power Isolated from Aux Power	M12 L-Coded, 5-pin power IN/OUT with 1 safe power capable zone	PSHU20P200PN000L-L5

EtherCAT®

Popular Part Number Configurations

Pilot Type	Thread Type	Power Source for Output 25-32	Power Connector	End Plate Part Number
Internal	NPT	Aux Power	7/8" 4-pin power IN/OUT with 1 safe power capable zone	PSHU20P200PT000A-P4
Internal	NPT	Logic Power Isolated from Aux Power	7/8" 4-pin power IN/OUT with 1 safe power capable zone	PSHU20P200PT000L-P4
Internal	NPT	Aux Power	7/8" 5-pin power IN/OUT with 1 safe power capable zone	PSHU20P200PT000A-P5
Internal	NPT	Logic Power Isolated from Aux Power	7/8" 5-pin power IN/OUT with 1 safe power capable zone	PSHU20P200PT000L-P5
Internal	NPT	Aux Power	M12 L-Coded, 5-pin power IN/OUT with 1 safe power capable zone	PSHU20P200PT000A-L5
Internal	NPT	Logic Power Isolated from Aux Power	M12 L-Coded, 5-pin power IN/OUT with 1 safe power capable zone	PSHU20P200PT000L-L5

D

Subbase & Manual Valves

H Series Micro

Modulflex Series

H Series ISO

Network Connectivity

DX ISOMAX Series

Valvair II Series



For inventory, lead times, and kit lookup, visit www.pdnplu.com

D175

Parker Hannifin Corporation
 Pneumatic Division
 Richland, Michigan
www.parker.com/pneumatics

Ordering Information

P2H Ethernet Node 32 DO - Overview

Designed to integrate directly with all H Series ISO valve sizes, the P2H Ethernet Network Node provides a compact, robust and cost-efficient solution for industrial ethernet connectivity to a PLC or other controls device that supports industrial ethernet protocols. The P2H Ethernet Network Node is offered as an end plate kit on the H Series valve for five sizes (HB, HA, H1, H2 and H3). The P2H Ethernet Network Node is suitable for use on a valve manifold with up to 32 solenoid outputs. P2H Ethernet Node connects to a network with two standard M12 D-coded connections. These two connections function as a switch to enable the network to be connected to another network device.

Power connectors are available in three styles:

- 7/8 4-pin
- 7/8 5-pin
- M12 L-Code 5-pin

The power connectors are arranged in an IN/OUT design, and this allows the flexibility to connect power to another down stream device, instead of running two separate cables from a power supply. Each power connector can supply up to 12 A of current on both Logic and Auxiliary power pins. All power connections support (OSSD) test pulsing if the P2H Ethernet Node is connected to a safety rated output device that uses test pulses to detect faults in a safety system.

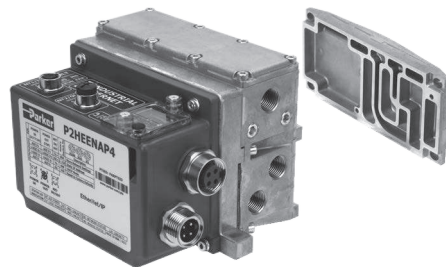

PSHU20 P2 0 0 P E 000 A - P4

Valve Type	
Plug-in (Internal pilot)	PSHU20
Plug-in (External pilot)	PSHU2X

Thread Type	
NPT	0
BSPP "G"	1

Network Connections	
EtherNet/IP™	E
EtherCAT	T
PROFINET	N
Modbus TCP	M
Powerlink	W

Power Connector	
7/8 4-pin Power IN/OUT with 1 Safe Power Capable Zone	P4
7/8 5-pin Power IN/OUT with 1 Safe Power Capable Zone	P5
M12 L-Code 5-pin IN/OUT with 1 Safe Power Capable Zone	L5

Right Hand End Plate Type / Thread Size	
Low profile (no ports)	0
1/2 Exhaust and Inlet Port	1
3/4 Exhaust and Inlet Port	2
H3 Transition Plate and End Plate (electrical pass through for plug-in valves only)	3
H3 Transition Plate and End Plate (expansion to 25th address for plug-in valves only)	4

Expansion Module / Power Source	
Power Source for Output 25-32: AUX Power	A
Power Source for Output 25-32: Logic Power	L

D
 Subbase & Manual Valves
 H Series Micro
 Modulflex Series
 H Series ISO
 Network Connectivity
 DX ISOMAX Series
 Valvair II Series



For inventory, lead times, and kit lookup, visit www.pdnplu.com

D176

Parker Hannifin Corporation
 Pneumatic Division
 Richland, Michigan
www.parker.com/pneumatics

P2H Ethernet Node 32 DO - Expansion Module

Note: An optional intermediate air supply module must be installed to the manifold for expansion from 25 – 32 solenoids, 24 to 31 addresses.

PSHU115A E 1 P

Mounting Style / Port Size	
Intermediate Air Supply, NPT / Internal Pilot	PSHU115A
Intermediate Air Supply, BSPP / Internal Pilot	PSHU115B*
Intermediate Air Supply, NPT / External Pilot	PSHU115C
Intermediate Air Supply, BSPP / External Pilot	PSHU115D*

* BSPP conforms to ISO 1179-1 w 228-1 threads.

Gasket Options	
1	1,3,5 Ports Open And Pilots Open
2	1,3,5 Ports Closed And Pilots Open
3	1 Closed, 3,5 Ports Open And Pilots Open
4	1 Port Open, 3,5 Ports Closed And Pilots Open
5	1,3,5 Ports Open And Pilots Closed
6	1,3,5 Ports Closed And Pilots Closed
7	1 Closed, 3,5 Ports Open And Pilots Closed
8	1 Port Open, 3,5 Ports Closed And Pilots Closed

Circuit Board Address Configuration	
E	With Electrical Expansion To 24th Address



Intermediate air supply module shown

Address Numbers

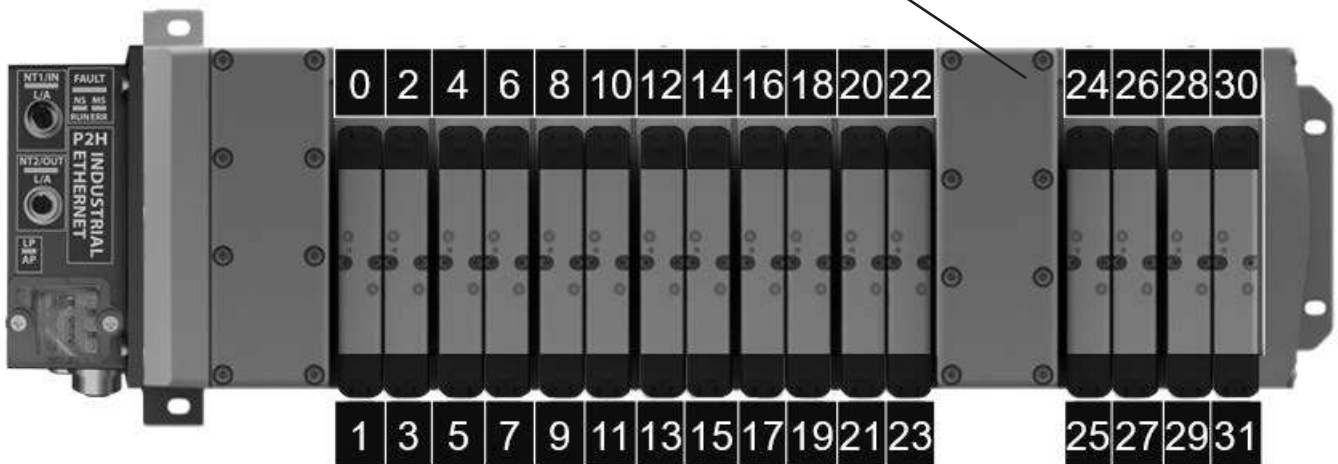

D
Subbase & Manual Valves
H Series Micro
Modulflex Series
H Series ISO
Network Connectivity
DX ISOMAX Series
Valvair II Series



For inventory, lead times, and kit lookup, visit www.pdnplu.com

D177

Parker Hannifin Corporation
 Pneumatic Division
 Richland, Michigan
www.parker.com/pneumatics

Ordering Information

P2H Ethernet Node 32 DO - Network Interface

The P2H Node 32DO allows connection to an industrial Ethernet Network via two M-12 D-Coded connectors (NT1 and NT2). An embedded switch allows for daisy-chaining ethernet communications. The connectors pin assignments are as follows:

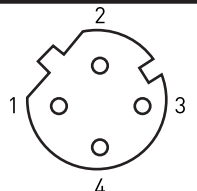
M12, D-coded, Female	Pin No.	Function
	1	Tx+
	2	Rx+
	3	Tx-
	4	Rx-

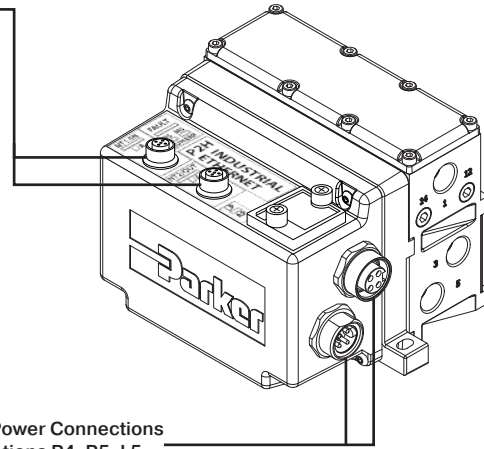

7/8 Power Connections
Options P4, P5, L5

D

Industrial Ethernet Options



Network Connections	
EtherNet/IP™	E
EtherCAT	T
PROFINET	N
Modbus TCP	M
Powerlink	W

Subbase & Manual
Valves

H Series
Micro

Modurflex
Series

H Series
ISO

Network
Connectivity

DX ISOMAX
Series

Valvair II
Series



For inventory, lead times, and kit lookup, visit www.pdnplu.com

D178

Parker Hannifin Corporation
 Pneumatic Division
 Richland, Michigan
www.parker.com/pneumatics

P2H Ethernet Node 32 DO - Power Options

- The P2H Ethernet Network Node has 3 available power connectors
- There are two power schemes that can be achieved detailed below
- H ISO Universal manifold valves draw power from the AUX power pins of the power connector

Consumption @ 24 VDC

AUX power max consumption	12A
Logic power max consumption	12A

Left over power that is not used by the P2H Ethernet Node can be passed on to other devices in the system through the power OUT connector



Power Connector *	
7/8 4-pin power in/out with 1 safe power capable zone	P4
7/8 5-pin power in/out with 1 safe power capable zone	P5
M12 L-Code 5-Pin in/out with 1 Safe Power Capable zone	L5

Power Connection Layout

The following three types of power connectors are available based on the end user's requirement. Current considerations should be used in the power connection selection process. Each power connection type can support a maximum of 12 A of current on each channel (VAUX and VLOG). When daisy chaining power is used, care must be taken in knowing the downstream current draw in order not to overload the maximum current rating of the pins.

	P4 - 7/8", 4-pin	P5 - 7/8", 5-pin	L5 - L-Coded, M12																																																			
TOP CONNECTOR	Power OUT	Power OUT	Power OUT																																																			
	<table border="1"> <thead> <tr> <th>Pin</th> <th>Function</th> <th>Description</th> </tr> </thead> <tbody> <tr> <td>1</td> <td>+ 24 V</td> <td>V2 (VAUX)</td> </tr> <tr> <td>2</td> <td>+ 24 V</td> <td>V1 (VLOG)</td> </tr> <tr> <td>3</td> <td>0 V</td> <td>GND V1 (VLOG)</td> </tr> <tr> <td>4</td> <td>0 V</td> <td>GND V2 (VAUX)</td> </tr> </tbody> </table>	Pin	Function	Description	1	+ 24 V	V2 (VAUX)	2	+ 24 V	V1 (VLOG)	3	0 V	GND V1 (VLOG)	4	0 V	GND V2 (VAUX)	<table border="1"> <thead> <tr> <th>Pin</th> <th>Function</th> <th>Description</th> </tr> </thead> <tbody> <tr> <td>1</td> <td>0 V</td> <td>GND V2 (VAUX)</td> </tr> <tr> <td>2</td> <td>0 V</td> <td>GND V1 (VLOG)</td> </tr> <tr> <td>3</td> <td>PE</td> <td>Protective Earth</td> </tr> <tr> <td>4</td> <td>+ 24 V</td> <td>V1 (VLOG)</td> </tr> <tr> <td>5</td> <td>+ 24 V</td> <td>V2 (VAUX)</td> </tr> </tbody> </table>	Pin	Function	Description	1	0 V	GND V2 (VAUX)	2	0 V	GND V1 (VLOG)	3	PE	Protective Earth	4	+ 24 V	V1 (VLOG)	5	+ 24 V	V2 (VAUX)	<table border="1"> <thead> <tr> <th>Pin</th> <th>Function</th> <th>Description</th> </tr> </thead> <tbody> <tr> <td>1</td> <td>+ 24 V</td> <td>V1 (VLOG)</td> </tr> <tr> <td>2</td> <td>0 V</td> <td>GND V2 (VAUX)</td> </tr> <tr> <td>3</td> <td>0 V</td> <td>GND V1 (VLOG)</td> </tr> <tr> <td>4</td> <td>+ 24 V</td> <td>V2 (VAUX)</td> </tr> <tr> <td>5</td> <td>PE</td> <td>Protective Earth</td> </tr> </tbody> </table>	Pin	Function	Description	1	+ 24 V	V1 (VLOG)	2	0 V	GND V2 (VAUX)	3	0 V	GND V1 (VLOG)	4	+ 24 V	V2 (VAUX)	5	PE	Protective Earth
	Pin	Function	Description																																																			
	1	+ 24 V	V2 (VAUX)																																																			
2	+ 24 V	V1 (VLOG)																																																				
3	0 V	GND V1 (VLOG)																																																				
4	0 V	GND V2 (VAUX)																																																				
Pin	Function	Description																																																				
1	0 V	GND V2 (VAUX)																																																				
2	0 V	GND V1 (VLOG)																																																				
3	PE	Protective Earth																																																				
4	+ 24 V	V1 (VLOG)																																																				
5	+ 24 V	V2 (VAUX)																																																				
Pin	Function	Description																																																				
1	+ 24 V	V1 (VLOG)																																																				
2	0 V	GND V2 (VAUX)																																																				
3	0 V	GND V1 (VLOG)																																																				
4	+ 24 V	V2 (VAUX)																																																				
5	PE	Protective Earth																																																				
BOTTOM CONNECTOR	Power IN	Power IN	Power IN																																																			
	<table border="1"> <thead> <tr> <th>Pin</th> <th>Function</th> <th>Description</th> </tr> </thead> <tbody> <tr> <td>1</td> <td>+ 24 V</td> <td>V2 (VAUX)</td> </tr> <tr> <td>2</td> <td>+ 24 V</td> <td>V1 (VLOG)</td> </tr> <tr> <td>3</td> <td>0 V</td> <td>GND V1 (VLOG)</td> </tr> <tr> <td>4</td> <td>0 V</td> <td>GND V2 (VAUX)</td> </tr> </tbody> </table>	Pin	Function	Description	1	+ 24 V	V2 (VAUX)	2	+ 24 V	V1 (VLOG)	3	0 V	GND V1 (VLOG)	4	0 V	GND V2 (VAUX)	<table border="1"> <thead> <tr> <th>Pin</th> <th>Function</th> <th>Description</th> </tr> </thead> <tbody> <tr> <td>1</td> <td>0 V</td> <td>GND V2 (VAUX)</td> </tr> <tr> <td>2</td> <td>0 V</td> <td>GND V1 (VLOG)</td> </tr> <tr> <td>3</td> <td>PE</td> <td>Protective Earth</td> </tr> <tr> <td>4</td> <td>+ 24 V</td> <td>V1 (VLOG)</td> </tr> <tr> <td>5</td> <td>+ 24 V</td> <td>V2 (VAUX)</td> </tr> </tbody> </table>	Pin	Function	Description	1	0 V	GND V2 (VAUX)	2	0 V	GND V1 (VLOG)	3	PE	Protective Earth	4	+ 24 V	V1 (VLOG)	5	+ 24 V	V2 (VAUX)	<table border="1"> <thead> <tr> <th>Pin</th> <th>Function</th> <th>Description</th> </tr> </thead> <tbody> <tr> <td>1</td> <td>+ 24 V</td> <td>V1 (VLOG)</td> </tr> <tr> <td>2</td> <td>0 V</td> <td>GND V2 (VAUX)</td> </tr> <tr> <td>3</td> <td>0 V</td> <td>GND V1 (VLOG)</td> </tr> <tr> <td>4</td> <td>+ 24 V</td> <td>V2 (VAUX)</td> </tr> <tr> <td>5</td> <td>PE</td> <td>Protective Earth</td> </tr> </tbody> </table>	Pin	Function	Description	1	+ 24 V	V1 (VLOG)	2	0 V	GND V2 (VAUX)	3	0 V	GND V1 (VLOG)	4	+ 24 V	V2 (VAUX)	5	PE	Protective Earth
	Pin	Function	Description																																																			
	1	+ 24 V	V2 (VAUX)																																																			
2	+ 24 V	V1 (VLOG)																																																				
3	0 V	GND V1 (VLOG)																																																				
4	0 V	GND V2 (VAUX)																																																				
Pin	Function	Description																																																				
1	0 V	GND V2 (VAUX)																																																				
2	0 V	GND V1 (VLOG)																																																				
3	PE	Protective Earth																																																				
4	+ 24 V	V1 (VLOG)																																																				
5	+ 24 V	V2 (VAUX)																																																				
Pin	Function	Description																																																				
1	+ 24 V	V1 (VLOG)																																																				
2	0 V	GND V2 (VAUX)																																																				
3	0 V	GND V1 (VLOG)																																																				
4	+ 24 V	V2 (VAUX)																																																				
5	PE	Protective Earth																																																				

*PE – Protective Earth



For inventory, lead times, and kit lookup, visit www.pdnplu.com

D179

Parker Hannifin Corporation
 Pneumatic Division
 Richland, Michigan
www.parker.com/pneumatics

D

Subbase & Manual Valves

H Series Micro

Moduflex Series

H Series ISO

Network Connectivity

DX ISOMAX Series

Valvair II Series

Ordering Information

P2H Ethernet Node 32 DO - Power Scheme 1 Option "A"

- All 32 addresses are controlled in the same power zone
- Safety zoning is possible for valve solenoids and, with the H ISO Universal valves, pneumatic pressure
- Power zone is safe power capable

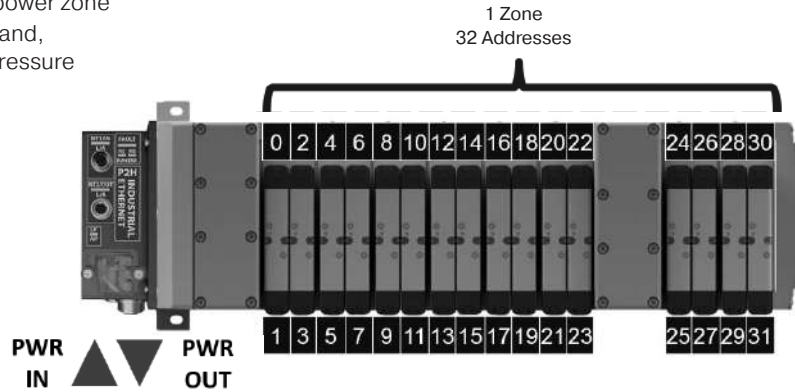

Power Scheme 2 Option "L"

- The 1st 24 addresses are supplied by auxiliary voltage power. The last 8 addresses are supplied by the logic voltage power.
- Each zone has an isolated safe ground pin so each can be powered by a SAFE 24 VDC auxiliary source in PP or PM mode. NOTE: You can treat each zone as a separate power zone/safe zone. Be aware that the last 8 addresses will be supplied by logic power. If power is shut down to this zone the P2H Ethernet module loses power and communication. This may cause extra time to reconnect to the network when power is restored.

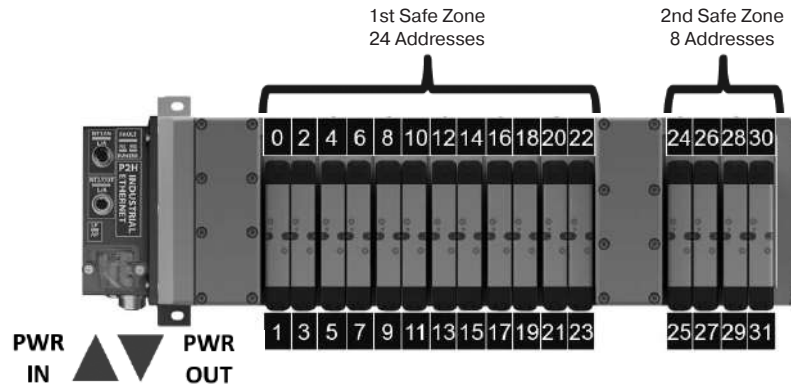

Industrial Ethernet Options



Expansion Module / Power Source	
Power Source for Output 25-32: AUX Power	A
Power Source for Output 25-32: Logic Power	L

D	Subbase & Manual Valves
	H Series Micro
	Modulflex Series
	H Series ISO
	Network Connectivity
	DX ISOMAX Series
	Valvair II Series



For inventory, lead times, and kit lookup, visit www.pdnplu.com

P2H Ethernet Node 32 DO - Safe Power Connectivity



P2H Ethernet Node connection to SAFE Power PP / PM mode for valve control

The P2H Ethernet Node 32DO Auxiliary Power for valves can be supplied from an OSSD (Output Signal Switching Device) 24 VDC safe output power source in PP (plus plus) or PM (plus minus) configurations. The connection diagram below represents power option "A". For power option "L" valve driver number 4 power would be supplied from the logic pins of the connection selected (please reference the power pinout diagram).

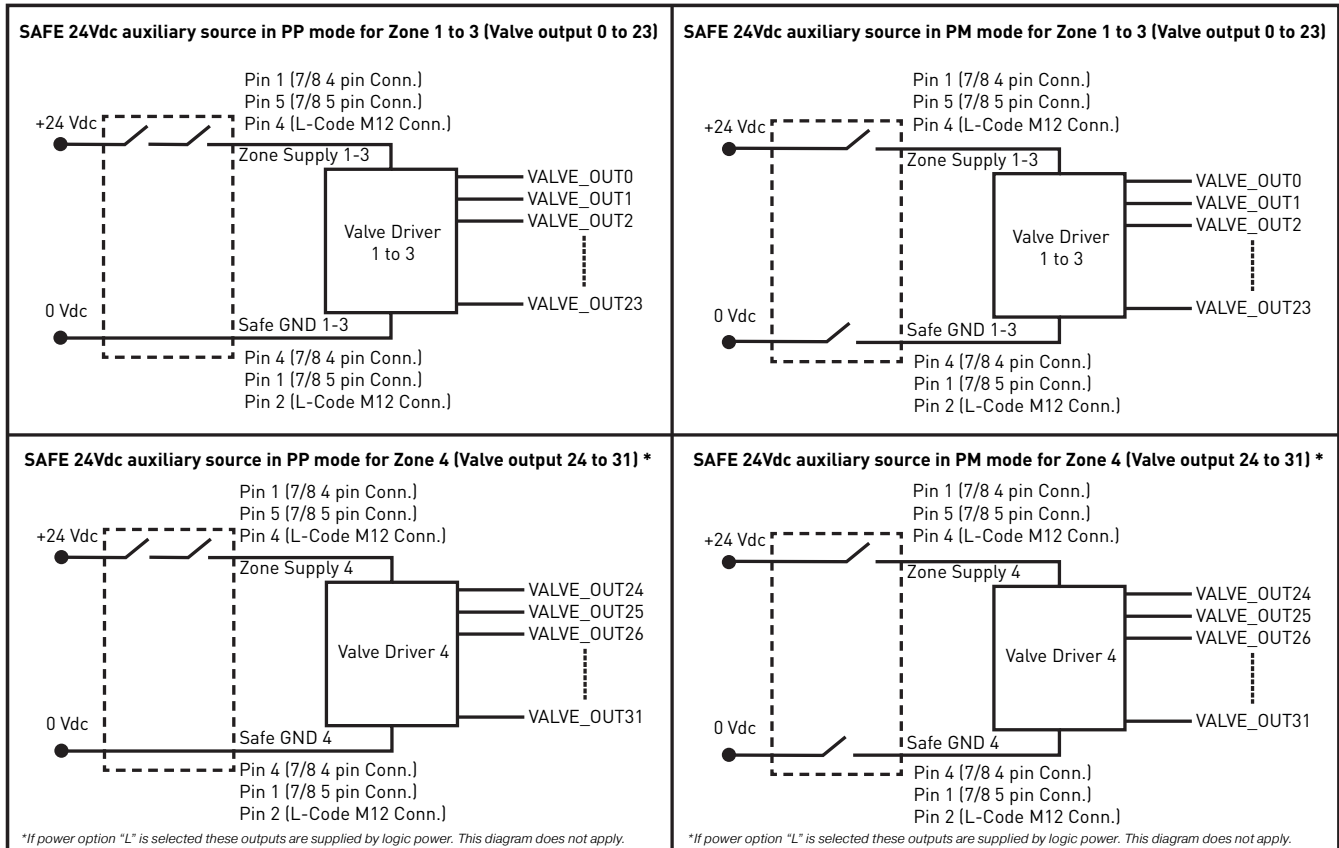

Note: Please check max. power available from the source. Refer to the ["Auxiliary power consumption calculation"](#) section.

* 7/8" logic power has no connection to internal P2H unit but does carryover to OUT 7/8" connector (for jumper logic power only). Logic power for P2H unit will be supplied from M12 (pin 1 & 3).

D
Subbase & Manual Valves
H Series Micro
Modulflex Series
H Series ISO
Network Connectivity
DX ISOMAX Series
Valvair II Series



For inventory, lead times, and kit lookup, visit www.pdnplu.com

P2H Ethernet Node 32 DO - Auxiliary Power Consumption Calculation

The P2H Node 32DO auxiliary power consumption calculation depends on the combination of the valves selected and the number of coils used. The table below can be used for power consumption calculation by valve type and the number of each type used. Take note that there are two types of coils for sizes 1,2,3. An energy efficient coil and standard coil.

Valve Range	Number of Pilots Simultaneously powered	Power	Total
H ISO - 15407-2 - Sizes 02 & 01	___	x 40 mA	= ___ mA
H ISO - 5599-2 - Sizes 1, 2 & 3 (Energy Efficiency Coils) *	___	x 54 mA	= ___ mA
H ISO - 5599-2 - Sizes 1, 2 & 3 (Standard Coils) **	___	x 133 mA	= ___ mA
		Total :	___ mA

* F9 Valve Voltage Code

** B9 Valve Voltage Code

Power Supply Diagnostics

Power Supply Diagnostics through LED

The P2H Node 32DO monitors the logic and auxiliary power supply voltages and manages two levels of diagnostics: warning and error range. Status is indicated via LEDs located on the device. The range limits can be modified through parameter data.

To restore default value (factory setting), refer to "Factory Reset Section" in the manual.

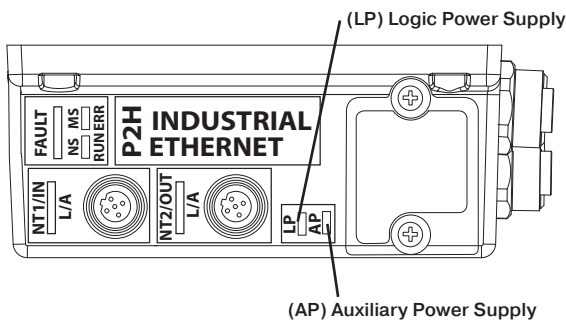

LP and AP (Green / Yellow) LEDs		
LED Status	Description	Troubleshooting
OFF	Logic and/or Aux lines not powered	Check power supply (see Power Supply section for pin assignments)
ON (Green)	Voltage in normal range	N/A
ON (Red)	Voltage in error range (too low or too high)	Check power supply (see Power Supply section for pin assignments)
Blinking (Red)	Voltage in warning range (out of normal range, not in error range)	Check power supply (see Power Supply section for pin assignments)
Blinking (Yellow)	Invalid rotary switch setting	Check rotary switch setting
Blinking (Red / Yellow)	Firmware version error or Completed "Reset to Factory" procedure	If switches setting different from "999" and no "Reset to Factory" performed via webpage, then contact technical support

LED function details:

- "Logic power" or "Aux power" error is active from 9.6 to 19.4 VDC or above 28.5 VDC
- When "Logic power error" or "Aux power error" is active, LED is solid red

Power Supply Diagnostics through Network and Process Data Mapping

Diagnostics are available in Process Input data (byte 0) to indicate whether Logic and Auxiliary voltages are within range. There is a warning range (normal operation with fault indication) and an error range (module enters Failsafe state).

The default warning range is set as 20.4 VDC < power supply < 26.4 VDC. These limits can be modified via acyclic data, objects # 11 and #12. The error range is set as 19.4 VDC < power supply < 28.5 VDC. These limits cannot be modified.

The voltage measured by the module, both Logic and Auxiliary, can be accessed via acyclic data, in Object #4. The displayed value is in mV.

D
 Subbase & Manual
 Valves
 H Series
 Micro
 Modulflex
 Series
 H Series
 ISO
 Network
 Connectivity
 DX ISOMAX
 Series
 Valvair II
 Series



For inventory, lead times, and kit lookup, visit www.pdnplu.com

P2H Ethernet Node 32 DO - Process Data mapping - Inputs

The following tables describes the input mapping for P2H Ethernet Node. The byte mapping order varies by protocol please reference the manual for specific byte order arrangement.

Channel Error – Input Mapping

Byte #	Input Bits								Description
	7	6	5	4	3	2	1	0	
1	EV07	EV06	EV05	EV04	EV03	EV02	EV01	EV00	
2	EV15	EV14	EV13	EV12	EV11	EV10	EV9	EV08	Valve Error Data
3	EV23	EV22	EV21	EV20	EV19	EV18	EV17	EV16	EVxx = Output on Valve range is 0 to 31
4	EV31	EV30	EV29	EV28	EV27	EV26	EV25	EV24	

Module Info Flags - Input Mapping

Byte #	Module Info Flags		
	Output Bits	Error Name	Error Description
1	0	Heartbeat not toggling AUX 1	Heartbeat is currently not toggling
	1	Heartbeat not toggling AUX 2	
	2	SPI COM Error AUX 1	Error in SPI Communication between AUX and Logic. Outputs are switched off
	3	SPI COM Error AUX 2	
	4	SPI COM Lost AUX 1	Communication not possible. Outputs are switched off
	5	SPI COM Lost AUX 2	
	6	Output Interconnect Error	Short circuit between outputs detected. Affected outputs switched off.
7	SPI NP40 Error	Error in communication between Logic and Comm	
2	0	NP40 Version Error	Comm Module Version error. Outputs are switched off
	1-7	Reserved	These bits will be always set as 0

Module Error Input – Input Mapping

Byte #	Module Error Input		
	Output Bits	Error Name	Error Description
1	0	AUX Voltage Warning	Set if Auxiliary Voltage in warning range. Module keeps normal operation
	1	AUX Voltage Error	Auxiliary Voltage in Error range. Outputs are switched OFF
	2	Logic Voltage Warning	Set if Logic voltage is out of range for warning.
	3	Logic Voltage Error	Set if Logic voltage is out of range for error. Outputs are switched OFF
	4	Temperature Warning	Set if a temperature increase above warning levels is detected by the output drivers
	5	Output Driver Channel Error	Set if a major fault is detected at the output stage – solenoid short circuit. Outputs are switched OFF
	6	Module Error	Set if an internal communication error is active
2	7	Auxiliary Power Not Available	Auxiliary Power is off
	0 - 7	Reserved	These bits will be always set as 0

D

Subbase & Manual Valves

H Series Micro

Modulflex Series

H Series ISO

Network Connectivity

DX ISOMAX Series

Valvair II Series



For inventory, lead times, and kit lookup, visit www.pdnplu.com

D183

Parker Hannifin Corporation
 Pneumatic Division
 Richland, Michigan
www.parker.com/pneumatics

P2H Ethernet Node 32 DO - Process Data mapping - Outputs

The following tables describes the input mapping for P2H Ethernet Node. The byte mapping order varies by protocol please reference the manual for specific byte order arrangement.

System Command – Output Mapping

Byte #	System Command Module								Description
	Output Bits								
	7	6	5	4	3	2	1	0	
1	System Command Value								One Byte that accepts the system command value see table below for values

Command Value	Command Name	Description
0X02	Store Switching Cycle Counters	When this command is executed, the current values of the switching cycle counters are stored into EEPROM. This command is intended to be used before powering off the device.
0X03	Store Diagnostic Log	When this command is executed, the diagnostic log is stored to the EEPROM.
0X04	Delete Diagnostic Log	Removes all diagnostic log entries in EEPROM (required by webpage).

Solenoids – Output Mapping

Byte #	Solenoid Module								Description
	Output Bits								
	7	6	5	4	3	2	1	0	
1	EV07	EV06	EV05	EV04	EV03	EV02	EV01	EV00	Valve Output Data EVxx -> Output on Valve range is 0 to 31
2	EV15	EV14	EV13	EV12	EV11	EV10	EV9	EV08	
3	EV23	EV22	EV21	EV20	EV19	EV18	EV17	EV16	
4	EV31	EV30	EV29	EV28	EV27	EV26	EV25	EV24	

D
 Subbase & Manual Valves
 H Series Micro
 Modulflex Series
 H Series ISO
 Network Connectivity
 DX ISOMAX Series
 Valvair II Series



For inventory, lead times, and kit lookup, visit www.pdnplu.com

P2H Ethernet Node 32 DO - Solenoid Addressing

- The P2H Ethernet Network Node can support up to 32 addresses as shown
- Addresses 25-31 can be accessed using an Intermediate Air Supply with Electric Expansion
- Each address is one solenoid

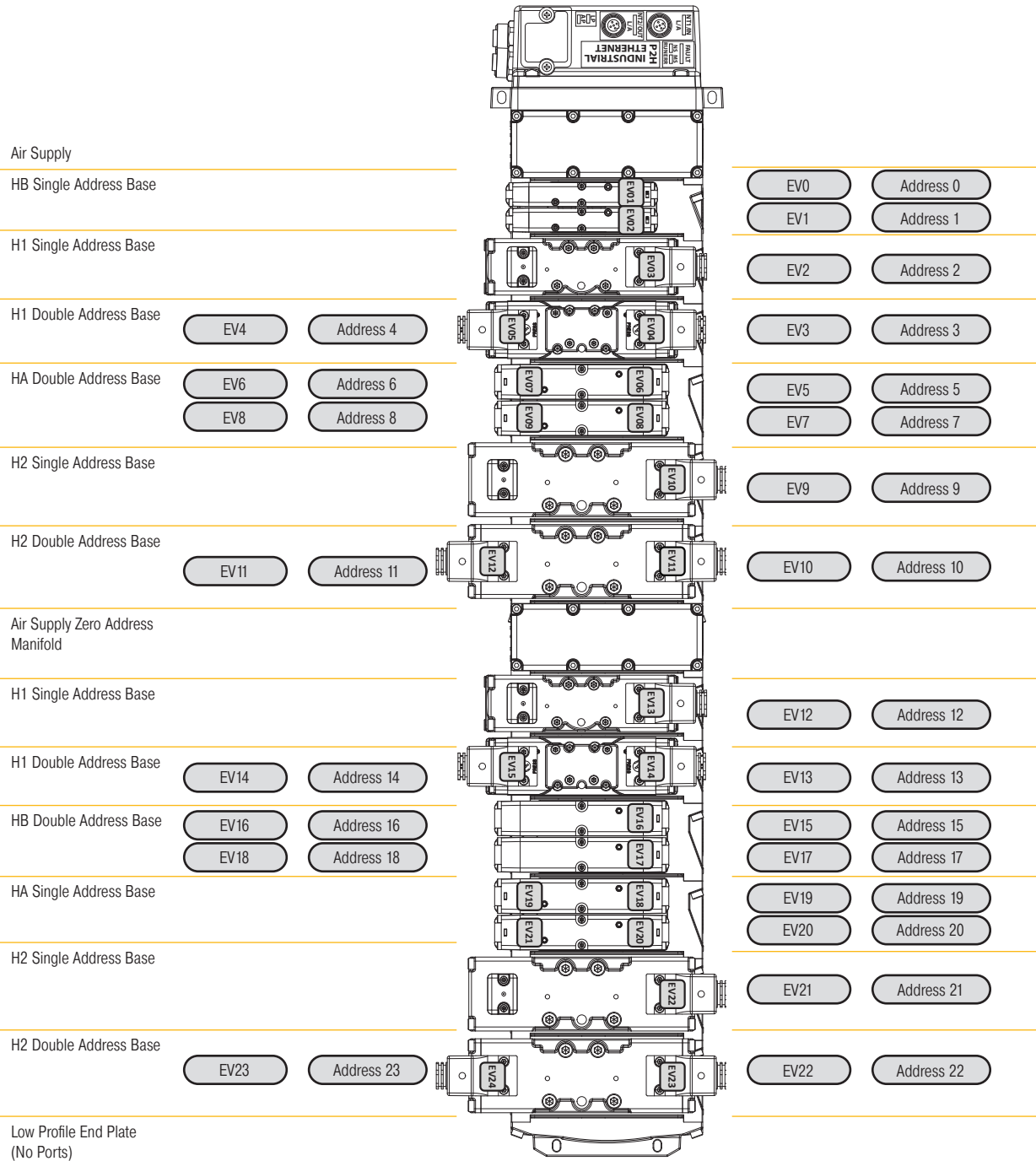

D	Subbase & Manual Valves
	H Series Micro
	Modulflex Series
	H Series ISO
	Network Connectivity
	DX ISOMAX Series
	Valvair II Series

P2H Ethernet Node 32 DO - Technical Data

Mechanical Data

Housing Material	Housing /Enclosure: PBT with 33% GF and UL94-V0 Base Cover (plate): Aluminium 380
Enclosure rating	IP 65 (only when plugged-in and threaded-in)
Power Connectors	7/8" 4 pin or 7/8" 5 pin or L-Coded M12 5-pin male and female pin connector
Dimensions (L x B x H in mm)	226.6mm x 130.7mm x 55mm
Mounting type	Screw Mount
Ground strap attachment	M5
Weight	Approx. 1.3 kg

Operating Conditions

Operating Temperature	0°C to 50°C
Storage Temperature	-25°C to 70°C
CE as per	IEC 61000-6-2 (Industrial Immunity) IEC 61000-6-4 (Industrial Emission)
Shock/Vibrations	IEC 60068-2-27:2008 IEC 60068-2-6:2007
Electrostatic Discharge	IEC 61000-4-2
Electrical Fast Transient/ Burst	IEC 61000-4-4
Surge Immunity	IEC 61000-4-5

Electrical Data

Supply Voltage	24VDC (-15% to +20%)
Logic current at 24 V (V1)	Max Current 8A – Actual usage depends on configuration
Auxiliary current at 24 V (V2)	Max Current 12A – Actual usage depends on configuration

Valve Configuration

Compatible Valves	H Universal ISO Valves
-------------------	------------------------

D

Subbase & Manual Valves

H Series Micro

Modulflex Series

H Series ISO

Network Connectivity

DX ISOMAX Series

Valvair II Series



For inventory, lead times, and kit lookup, visit www.pdnplu.com

D186

Parker Hannifin Corporation
 Pneumatic Division
 Richland, Michigan
www.parker.com/pneumatics

P2H Ethernet Node 32 DO - H Series ISO Valves

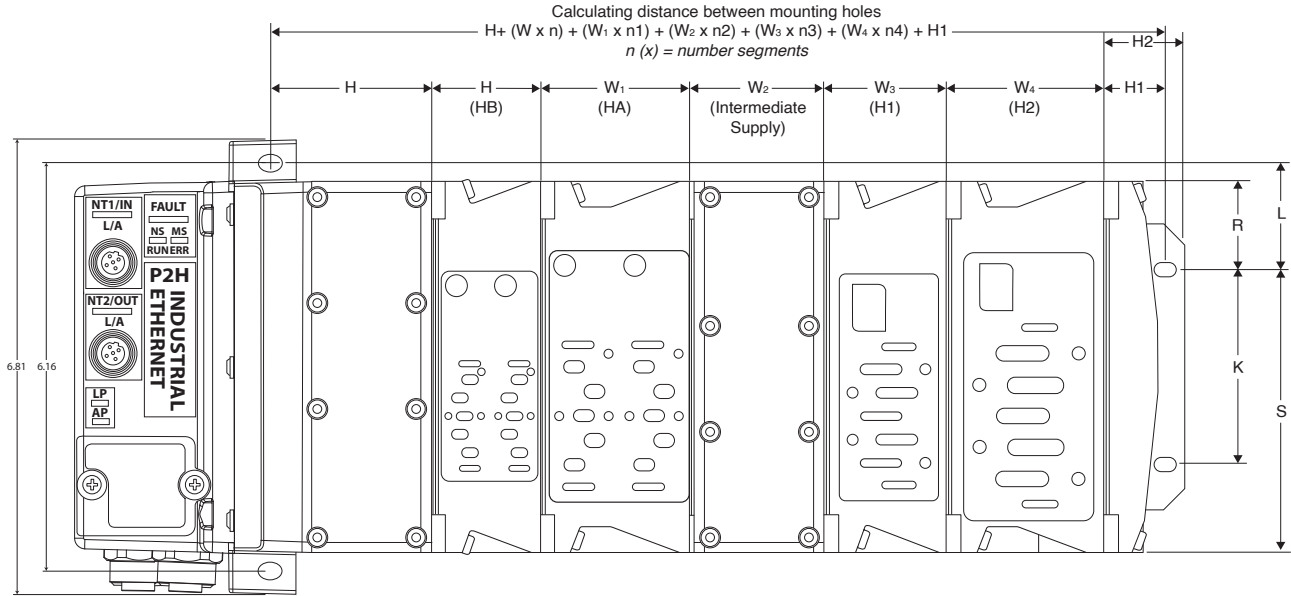

n (x) = number of segments

A	B	C	D	E	F	G	H	H1	H2	J	K	L
4.42 (112.3)	2.64 (67.1)	2.46 (62.5)	1.17 (29.7)	.55 (14)	9.32 (236.7)	1.51 (38.4)	2.36 (59.9)	.9 (22.9)	1.22 (31)	1.55 (39.4)	2.95 (74.9)	1.6 (40.6)
M	O	P	Q	R	S	T	W	W1	W2	W3	W4	
8.91 (226.3)	5.61 (142.5)	6.86 (174.2)	6.18 (157)	1.33 (33.8)	4.28 (108.7)	7.14 (181.4)	1.63 (41.4)	2.28 (57.9)	2.03 (51.6)	1.82 (46.2)	2.39 (60.7)	

Inches (mm)

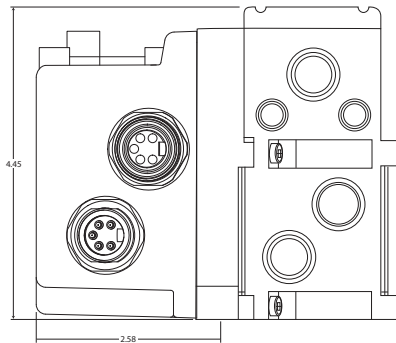

D

Subbase & Manual
Valves

H Series
Micro

Modulflex
Series

H Series
ISO

Network
Connectivity

DX ISOMAX
Series

Valvair II
Series



For inventory, lead times, and kit lookup, visit www.pdnplu.com

D187

Parker Hannifin Corporation
Pneumatic Division
Richland, Michigan
www.parker.com/pneumatics

D

Subbase & Manual
Valves

H Series
Micro

Modulflex
Series

H Series
ISO

Network
Connectivity

DX ISOMAX
Series

Valvaire II
Series



For inventory, lead times, and kit lookup, visit www.pdnplu.com

D188

Parker Hannifin Corporation
Pneumatic Division
Richland, Michigan
www.parker.com/pneumatics

Features

PCH Network Portal

Features

- Industrial Ethernet Communication
- Truly Configurable I/O
- Feature Rich Webserver
- Built-In Technician
- 3 Available Module Variants, 4 ports each
- Bluetooth Connectivity
- Flexible power connectors allowing daisy chain
- Certified to IP65 ingress protection
- Weld splatter resistant housing material
- Welding Noise Immune
- Safe Power Capable
- Built-in configurable IO-Link Master Ports

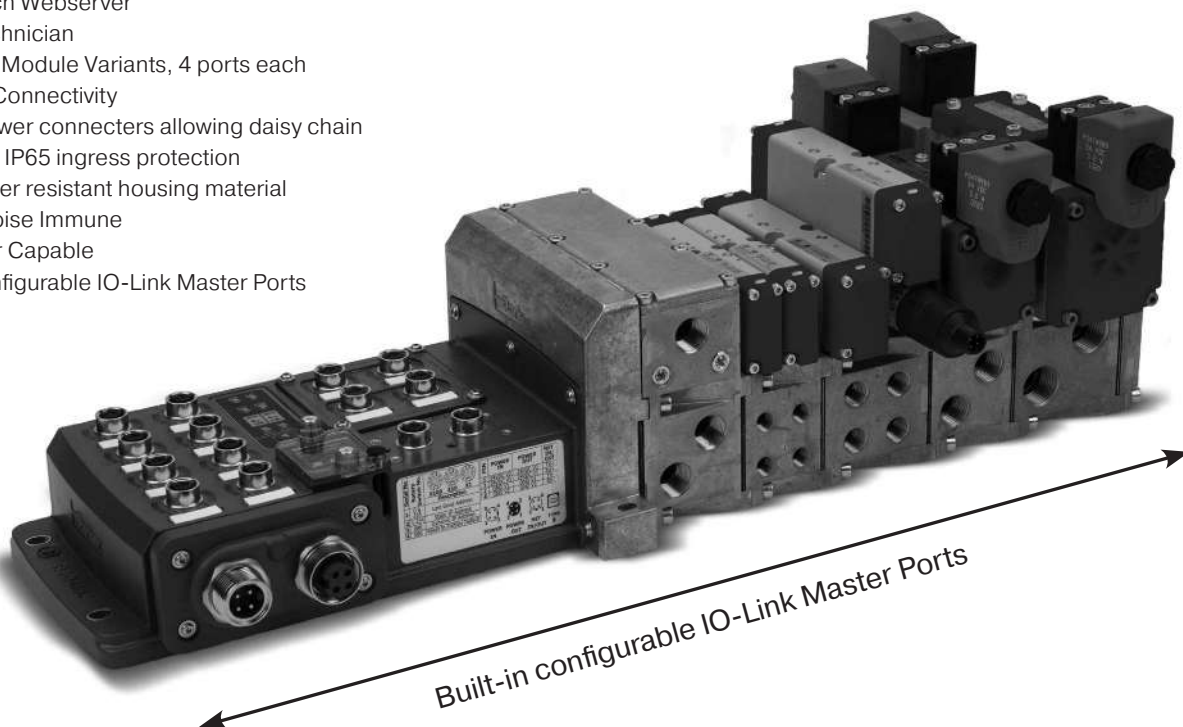

The PCH Network Portal redefines and revolutionizes decentralized machine I/O's architecture. The PCH Network Portal was engineered to support industrial ethernet protocols and the open protocol IO-Link with configurable inputs/outputs with true PNP/NPN circuitry switching on each port for easy machine design changes. This integrated configurability gives the user flexibility in designing custom I/O architecture on the fly.

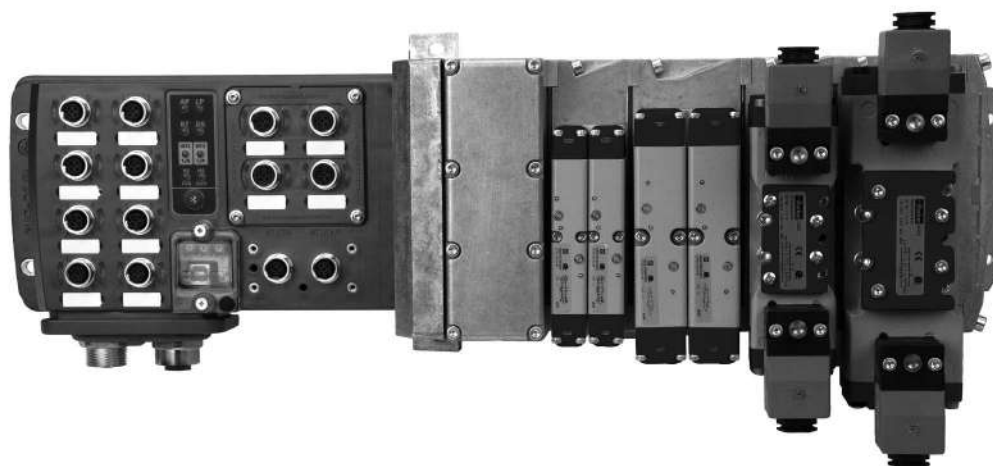

EtherNet/IP™

PROFINET
INDUSTRIAL ETHERNET

EtherCAT®

Modbus
TCP/IP

The PCH Network Portal can be assembled to Parker's H ISO Universal Manifold Platform, giving you access to a wide variety of low ranges all on one manifold.

D
Subbase & Manual Valves
H Series Micro
Moduflex Series
H Series ISO
Network Connectivity
DX ISOMAX Series
Valvair II Series



For inventory, lead times, and kit lookup, visit www.pdnplu.com

D189

Parker Hannifin Corporation
Pneumatic Division
Richland, Michigan
www.parker.com/pneumatics

Intuitive Interfaces

Modern factories recognize that plant floor architecture is an important structural part of machine design that can make a real difference in managing costs for future changes, integrations and expansions. The PCH Network Portal design team lived in this environment, therefore intuitive interfaces and complete modularity was the heart of PCH Network Portal design concepts.

As with all Cyber Physical Systems (CPS), intuitive interfaces are the backbone of simplicity in application. The PCH Network Portal offers several means of intuitive and embedded interfaces to shorten commission time.

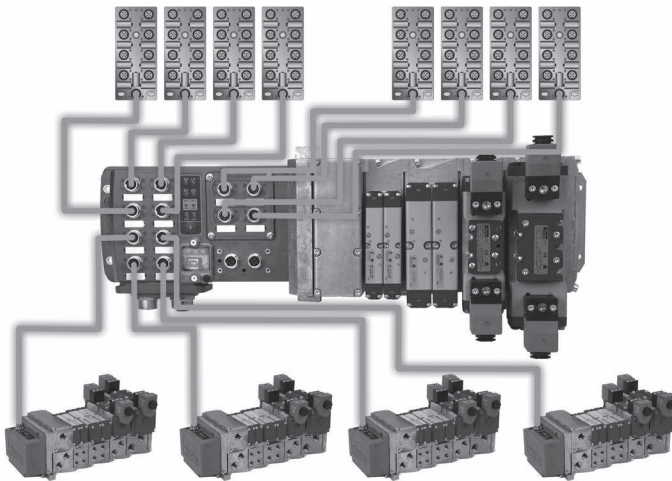
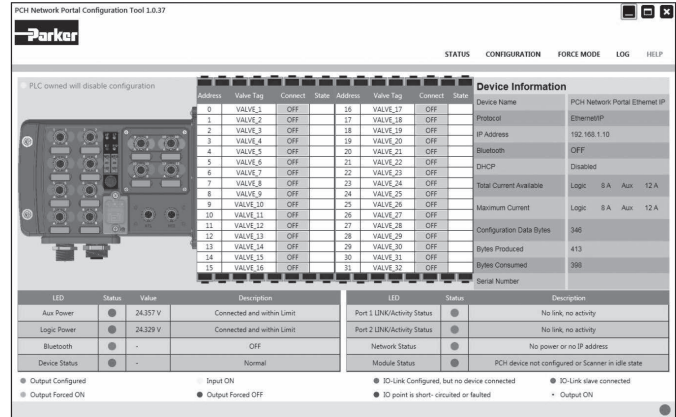

IO-Link

Value Redefined

The PCH Network Portal minimizes machine costs by redefining the traditional process of connectivity within a single footprint that provides multiple configurations. The flexibility of configurable I/O combined with built-in IO-Link master ports revolutionizes machine design and can save thousands of dollars at the design phase which typically accounts for 30-40% of overall costs. Changes can be made to the system with easy software reconfiguration of ports eliminating the need for additional hardware or time consuming programming.

Can't access the PLC? No Problem!

With meticulously designed embedded configuration tools, the PCH Network Portal can serve as your **virtual technician** to make problems easy to troubleshoot. A laptop, tablet or phone can access usable prognostic/diagnostic data and time stamped event logs to make accessing data and commissioning your machine simple. Once you've finished your configuration, the device's configuration profile can be downloaded and easily uploaded to other PCH Network Portals on your machine.

Configure via:

- Bluetooth App via phone or tablet
- Bluetooth connection via PC
- Integrated Webpage via ethernet connection
- Stand-a-lone "PCH Portal Configuration Tool" software via USB-B

Safety Foot Note:
 Bluetooth application cannot turn on outputs if a PLC where present and in control. The application cannot override the PLC at any time.



D
 Subbase & Manual Valves
 H Series Micro
 Modulflex Series
 H Series ISO
 Network Connectivity
 DX ISOMAX Series
 Valvaire II Series



For inventory, lead times, and kit lookup, visit www.pdnplu.com

D190

Parker Hannifin Corporation
 Pneumatic Division
 Richland, Michigan
www.parker.com/pneumatics

Features

Truly Configurable I/O

Configurable I/O means last minute design changes are now simple. Each PCH Network Portal is offered with three selectable modules that make up twelve configurable ports. All modules can be configured IO-Link A, IO-Link B or dual configurable I/O ports with true PNP/NPN circuitry switching on each port providing easy point and click changes on individual pins to customize a setup. Last minute design changes to the machine require minimal effort and no additional software or hardware. The ability to customize the machine design is no longer limited by the product.

H Series ISO & Network Connectivity PCH Network Portal

Port Config

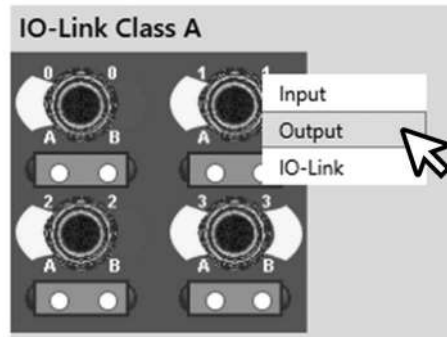

Tools Designed for Productivity

When a line stops and needs a reset you are often left wondering why. The root cause can seem a mystery and often stems back to over voltage or other power issues caused by the plant floor. Working with the PCH Network Portal is like having your own built-in technician. Rolling 40 errors, warnings and events are time and date stamped allowing you to spend time on what matters - running the facility. Let PCH Network Portal give you the detail so time can be better utilized elsewhere.

Built-In Technician

When using the 'PCH Portal Configuration Tool' your built-in technician comes to life with easy to follow screens for readouts, adjustments, and settings. Configuring the PCH Network Portal to the network is easy. Fast and storable configurations combined with embedded smart diagnostic and prognostic tools like built-in debounce times and up/down counters translate to quick change-over and short downtime. Further problems are easy to spot with the rolling 40 error, warnings, and events log which are time stamped. No more guessing at what went wrong in plant. Commissioning and troubleshooting a tool can even be done remotely from outside the work cell via the device's secure and lockable Bluetooth connectivity.

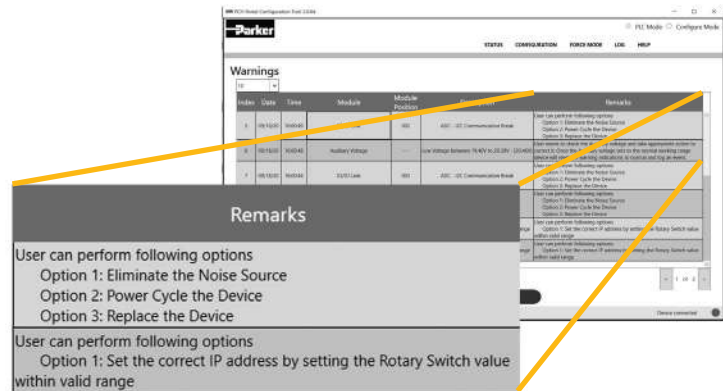

For inventory, lead times, and kit lookup, visit www.pdnplu.com

D
 Subbase & Manual Valves
 H Series Micro
 Modutex Series
 H Series ISO
 Network Connectivity
 DX ISOMAX Series
 Valvair II Series

Value Redefined

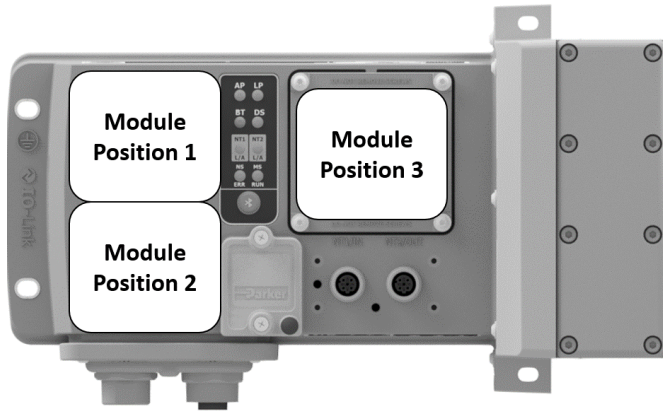

What are Module Positions?

- The PCH Network Portal is split into 3 Module Positions
- Each Module Position can accept different Module Variants to meet the application needs
- Populating a Module Position with an I/O Module Variant gives the PCH Network Portal 4 configurable M12 ports

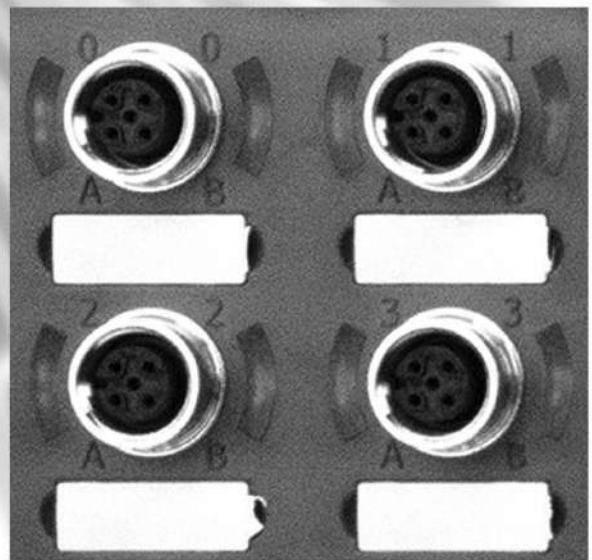
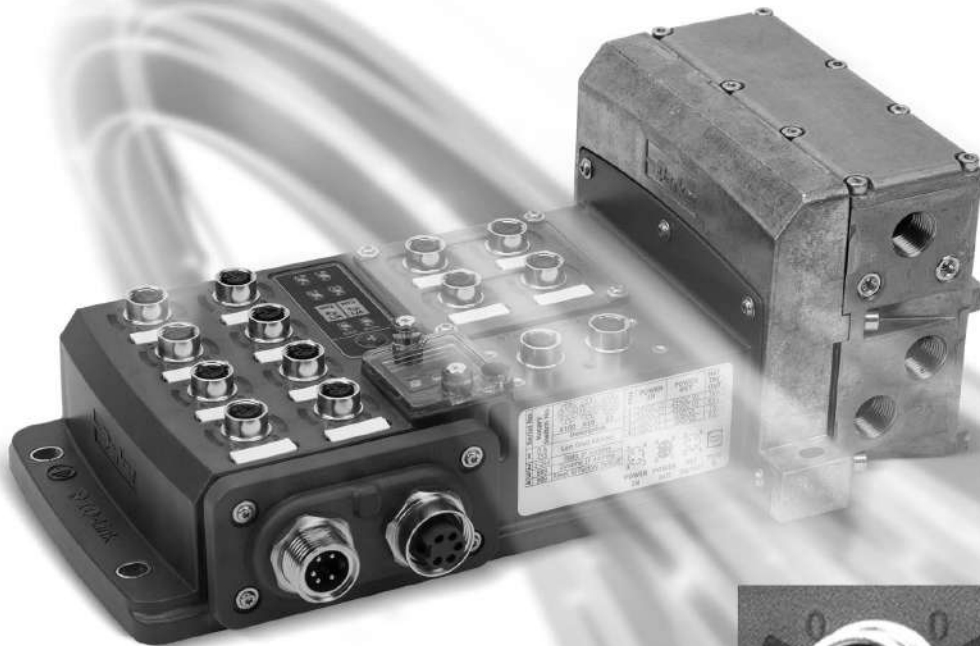

What is a Module Variant?

- 3 Module Variants are proposed offering each different capabilities (see details of Modules Variant A, B or C in next pages)
- A Module Variant offers 4 configurable M12 ports
- Depending on the Module Variant A, B or C selected, each M12 port can be individually configured differently between a variety of different behaviors

For Example

- With the Module Position 1 populated with Module Variant A, each M12 port can be individually configured as either IO-Link Class A Master or 2 Digital Inputs or 2 Digital Outputs
- A summary of the Module Variant offerings is on page D179

D	Subbase & Manual Valves
H Series Micro	Modulflex Series
H Series ISO	Network Connectivity
DX ISOMAX Series	Valvair II Series



For inventory, lead times, and kit lookup, visit www.pdnplu.com

PCH Network Portal

Module Variants

Module

A

What is a Module Variant?

- The PCH Network Portal has 3 available Module Positions. Each module position can be populated with three different Module Variants
- Each Module Position can accept all module variants

Port Behavior

- Each port is capable of the following behavior listed below
- Through software, the user can click and change how the port behaves on the fly
- The A Module Variant gives the user access to IO-Link Class A Master ports



Possible Port Behavior

IO-Link, Class A Master or
 2 x Digital Inputs or
 2 x Digital Outputs*

IO-Link, Class A Master or
 2 x Digital Inputs or
 2 x Digital Outputs*

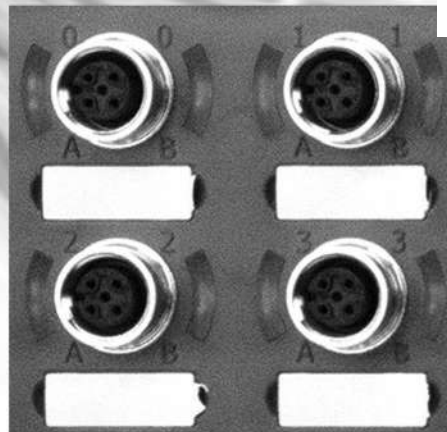

IO-Link, Class A Master or
 2 x Digital Inputs or
 2 x Digital Outputs*

IO-Link, Class A Master or
 2 x Digital Inputs or
 2 x Digital Outputs*

*Digital Output draws current from logic power

Port Behavior

- Each port's behavior can differ from one another
- For example, the user can select the behavior listed below through software (shown below)

IO-Link, Class A Master or
2 x Digital Inputs
 2 x Digital Outputs

IO-Link, Class A Master or
 2 x Digital Inputs or
2 x Digital Outputs

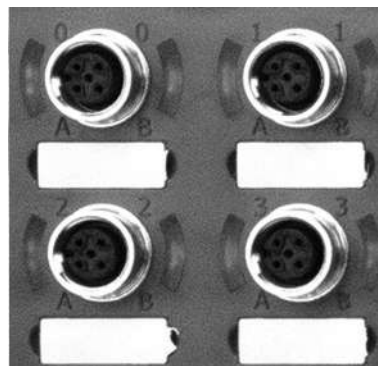

IO-Link, Class A Master
 2 x Digital Inputs or
 2 x Digital Outputs

IO-Link, Class A Master or
 2 x Digital Inputs or
2 x Digital Outputs

D

Subbase & Manual Valves

H Series Micro

Modulflex Series

H Series ISO

Network Connectivity

DX ISOMAX Series

Valvair II Series



For inventory, lead times, and kit lookup, visit www.pdnplu.com

D193

Parker Hannifin Corporation
 Pneumatic Division
 Richland, Michigan
www.parker.com/pneumatics

PCH Network Portal

Module Variants

Module

B

What is a Module Variant?

- The PCH Network Portal has 3 available Module Positions. Each module position can be populated with three different Module Variants
- Each Module Position can accept all module variants

Port Behavior

- Each port is capable of the following behavior listed below
- Through software, the user can click and change how the port behaves on the fly
- The B Module Variant gives the user access to IO-Link Class B Master ports



Possible Port Behavior

- IO-Link, Class B Master or
1 x Digital Input or
1 x Digital Output*
- IO-Link, Class B Master or
1 x Digital Input or
1 x Digital Output*

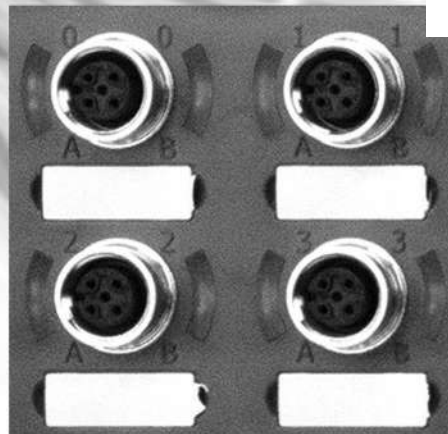

- IO-Link, Class B Master or
1 x Digital Input or
1 x Digital Output*
- IO-Link, Class B Master or
1 x Digital Input or
1 x Digital Output*

*Digital Output draws current from logic power

Port Behavior

- Each port's behavior can differ from one another
- For example, the user can select the behavior listed below through software (shown below)

- IO-Link, Class B Master or
1 x Digital Input
- IO-Link, Class B Master or
1 x Digital Input or
1 x Digital Output

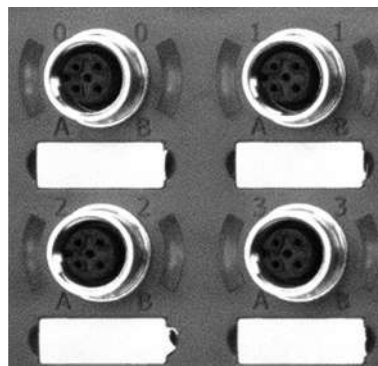

- IO-Link, Class B Master**
- 1 x Digital Input or
1 x Digital Output
- IO-Link, Class B Master or
1 x Digital Input or
1 x Digital Output

D

Subbase & Manual Valves

H Series Micro

Modulflex Series

H Series ISO

Network Connectivity

DX ISOMAX Series

Valvair II Series



For inventory, lead times, and kit lookup, visit www.pdnplu.com

PCH Network Portal

Module Variants

Module

C

What is a Module Variant?

- The PCH Network Portal has 3 available Module Positions. Each module position can be populated with three different Module Variants
- Each Module Position can accept all module variants

Port Behavior

- Each port is capable of the following behavior listed below
- Through software, the user can click and change how the port behaves on the fly
- The C Module Variant gives the user access to IO-Link Class B Master ports and fixed high current outputs



Possible Port Behavior

2 x Digital Outputs, 500 mA each, Fixed ¥

IO-Link, Class B Master or
 1 x Digital Input or
 1 x Digital Output*

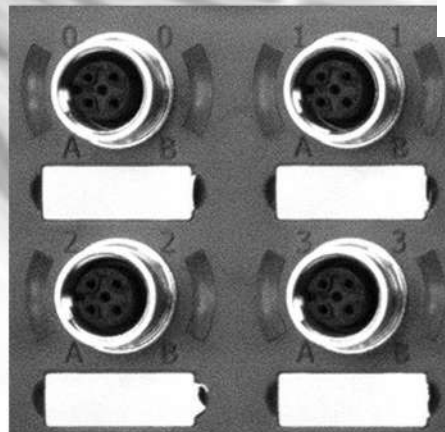

2 x Digital Outputs, 500 mA each, Fixed ¥

IO-Link, Class B Master or
 1 x Digital Input or
 1 x Digital Output*

¥ Digital Outputs draw current from auxiliary power
 * Digital Output draws current from logic power

Port Behavior

- Each port's behavior can differ from one another
- For example, the user can select the behavior listed below through software (shown below)

D

- Subbase & Manual Valves
- H Series Micro
- Moduflex Series
- H Series ISO
- Network Connectivity
- DX ISOMAX Series
- Valvair II Series



For inventory, lead times, and kit lookup, visit www.pdnplu.com

I/O Module Combinations

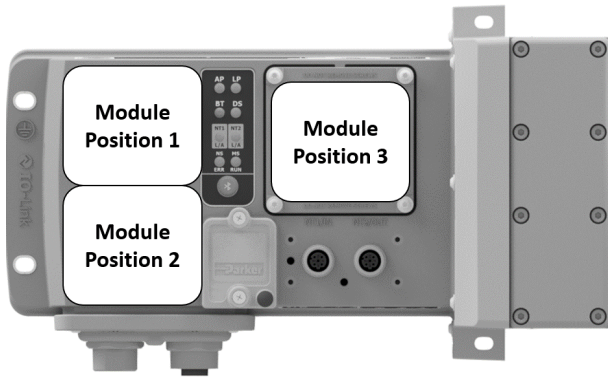

- The PCH Network Portal gives true port flexibility
- The PCH Network Portal can be ordered with 3 available module variants
- Each module variant has 4, M12 Ports
- Each module variants can be chosen in any module position
- Each port is individually software configurable
- A blanking plate is available for Module Position 3
- **Important:** Once Module Variants are selected on the PCH Network Portal, they cannot be changed in the field

Before it comes through your door
 Select which Module Variant you want in each Module Position



After it comes through your door
 Truly Configurable I/O - Select port behavior from listed options

D

Subbase & Manual Valves

H Series Micro

Modulflex Series

H Series ISO

Network Connectivity

DX ISOMAX Series

Valvair II Series

Module Variants

Module A		IO-Link, Class A Master OR 2 Inputs, PNP/NPN OR 2 Outputs, 250 mA ea		IO-Link, Class A Master OR 2 Inputs, PNP/NPN OR 2 Outputs, 250 mA ea
		IO-Link, Class A Master OR 2 Inputs, PNP/NPN OR 2 Outputs, 250 mA ea		IO-Link, Class A Master OR 2 Inputs, PNP/NPN OR 2 Outputs, 250 mA ea
Module B		IO-Link, Class B Master OR 1 Input, PNP/NPN OR 1 Output, 250 mA ea		IO-Link, Class B Master OR 1 Input, PNP/NPN OR 1 Output, 250 mA ea
		IO-Link, Class B Master OR 1 Input, PNP/NPN OR 1 Output, 250 mA ea		IO-Link, Class B Master OR 1 Input, PNP/NPN OR 1 Output, 250 mA ea
Module C		2 Outputs, 500 mA ea		2 Outputs, 500 mA ea
		IO-Link, Class B Master OR 1 Input, PNP/NPN OR 1 Output, 250 mA ea		IO-Link, Class B Master OR 1 Input, PNP/NPN OR 1 Output, 250 mA ea
Module N	Blank Cover, No Ports, Only available in Position 3			

I/O Module Combinations

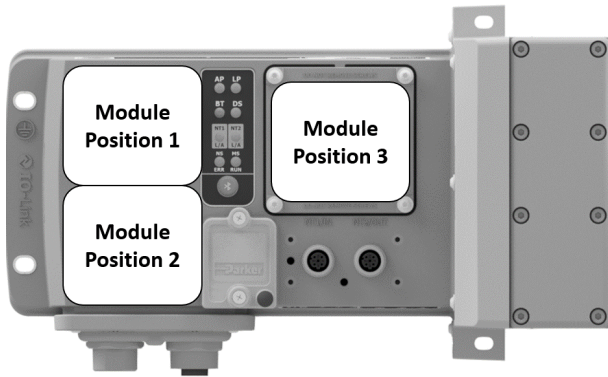

- Below are 16 standard module combinations
- For simplicity, similar combinations of modules are consolidated into one combination

For Example:



Example Model Structure

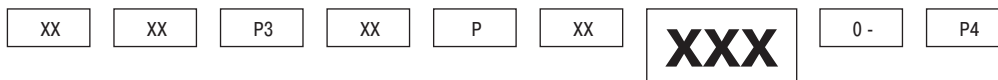

Below are the standard module configurations

Refer to page 183 for full product Module Structure.

Order Code	Module Position 1	Module Position 2	Module Position 3
AAA	A	A	A
AAB	A	A	B
AAC	A	A	C
AAN	A	A	N
ABB	A	B	B
ABC	A	B	C
ABN	A	B	N
ACC	A	C	C
ACN	A	C	N
BBB	B	B	B
BBC	B	B	C
BBN	B	B	N
BCC	B	C	C
BCN	B	C	N
CCC	C	C	C
CCN	C	C	N

For any module configurations not listed, consult factory.

D

Subbase & Manual Valves

H Series Micro

Modulflex Series

H Series ISO

Network Connectivity

DX ISOMAX Series

Valvair II Series



Power Options

- The PCH Network Portal has 4 available power connectors
- There are two power schemes that can be achieved detailed below
- Any I/O ports using AUX power and any attached H ISO Universal manifold valves draw power from the AUX power pins of the power connector

Consumption @ 24 VDC

AUX power max consumption	12A
Logic power max consumption	8A
Total possible passthrough for AUX line and Logic	20A

Any power left over can be passed on to other devices on the network

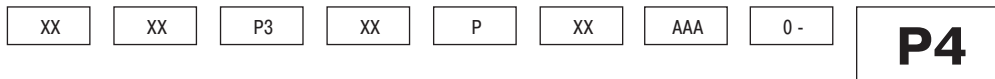

Power Connector *	
4-pin power in/out with 1 safe power capable zone	P4
5-pin power in/out with 1 safe power capable zone	P5
4-pin power in/in with 2 safe power zones	S4
5-pin power in/in with 2 safe power zones	S5

Power Scheme 1

- All 32 addresses are controlled in the same power zone
- Safety zoning is possible for valve solenoids and, with the H ISO Universal valves, pneumatic pressure
- Power zone is safe power capable
- Available in 4 or 5-pin 7/8" power connectors

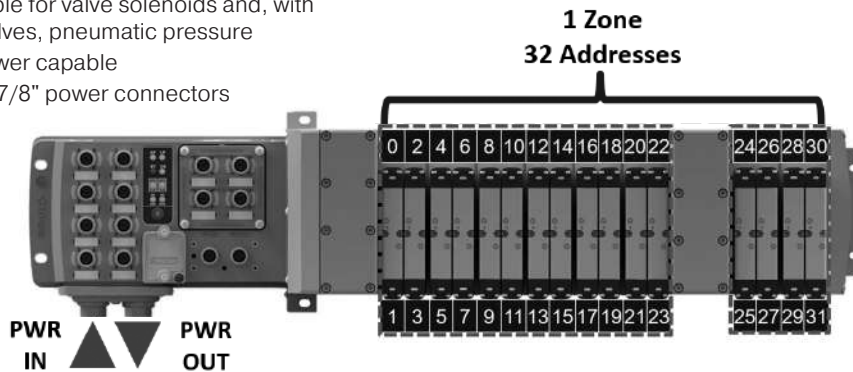

Power Scheme 2

- The power connector separates the valve power
- Each zone has an isolated safe ground pin so each can be powered by a SAFE 24 VDC auxiliary source in PP or PM mode
- Available in 4 or 5 pin 7/8" power connectors

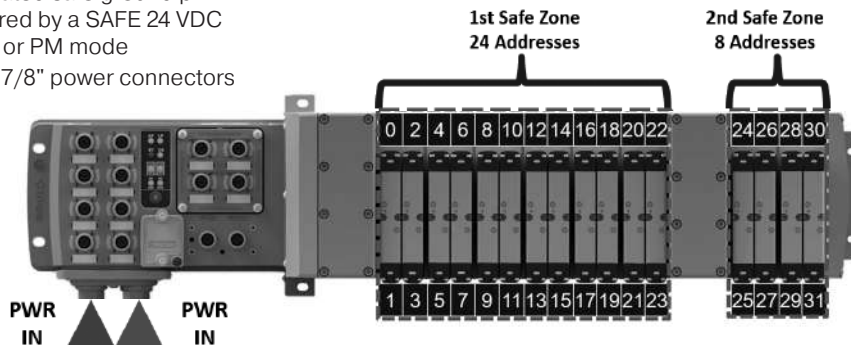

D
 Subbase & Manual Valves
 H Series Micro
 Modulflex Series
 H Series ISO
 Network Connectivity
 DX ISOMAX Series
 Valvair II Series



For inventory, lead times, and kit lookup, visit www.pdnplu.com

D198

Parker Hannifin Corporation
 Pneumatic Division
 Richland, Michigan
www.parker.com/pneumatics

Popular Module Combinations

- Listed below are popular module configurations
- For full model number structure, please refer to next page

EtherNet/IP™

Popular Part Number Configurations						
Pilot Type	Thread Type	Module Position			Power Connector	End Plate Part Number
		1	2	3		
Internal	NPT	A	A	A	4-pin power IN/OUT with 1 safe power capable zone	PSHU20P300PEAAA0-P4
Internal	NPT	A	A	B	4-pin power IN/OUT with 1 safe power capable zone	PSHU20P300PEAAB0-P4
Internal	NPT	A	B	C	4-pin power IN/OUT with 1 safe power capable zone	PSHU20P300PEABC0-P4
Internal	NPT	A	A	N	4-pin power IN/OUT with 1 safe power capable zone	PSHU20P300PEAAN0-P4
Internal	NPT	A	A	A	5-pin power IN/OUT with 1 safe power capable zone	PSHU20P300PEAAA0-P5
Internal	NPT	A	A	B	5-pin power IN/OUT with 1 safe power capable zone	PSHU20P300PEAAB0-P5
Internal	NPT	A	A	C	5-pin power IN/OUT with 1 safe power capable zone	PSHU20P300PEAAC0-P5
Internal	NPT	A	A	N	5-pin power IN/OUT with 1 safe power capable zone	PSHU20P300PEAAN0-P5
Internal	NPT	A	A	A	4-pin power IN/IN with 2 safe power zones	PSHU20P300PEAAA0-S4
Internal	NPT	A	A	N	5-pin power IN/IN with 2 safe power zones	PSHU20P300PEAAN0-S5



Popular Part Number Configurations						
Pilot Type	Thread Type	Module Position			Power Connector	End Plate Part Number
		1	2	3		
Internal	NPT	A	A	A	5-pin power IN/OUT with 1 safe power capable zone	PSHU20P300PNAAA0-P5
Internal	NPT	A	A	B	5-pin power IN/OUT with 1 safe power capable zone	PSHU20P300PNAAB0-P5
Internal	NPT	A	B	C	5-pin power IN/OUT with 1 safe power capable zone	PSHU20P300PNABC0-P5
Internal	NPT	A	A	N	5-pin power IN/OUT with 1 safe power capable zone	PSHU20P300PNAAN0-P5
Internal	NPT	A	A	A	5-pin power IN/OUT with 1 safe power capable zone	PSHU20P300PNAAA0-P5
Internal	NPT	A	A	B	5-pin power IN/IN with 2 safe power zones	PSHU20P300PNAAB0-S5
Internal	NPT	A	A	C	5-pin power IN/IN with 2 safe power zones	PSHU20P300PNAAC0-S5
Internal	NPT	A	A	N	5-pin power IN/IN with 2 safe power zones	PSHU20P300PNAAN0-S5
Internal	NPT	A	A	A	5-pin power IN/IN with 2 safe power zones	PSHU20P300PNAAA0-S5
Internal	NPT	A	A	N	5-pin power IN/IN with 2 safe power zones	PSHU20P300PNAAN0-S5



Popular Part Number Configurations						
Pilot Type	Thread Type	Module Position			Power Connector	End Plate Part Number
		1	2	3		
Internal	NPT	A	A	A	4-pin power IN/OUT with 1 safe power capable zone	PSHU20P300PTAAA0-P4
Internal	NPT	A	A	B	4-pin power IN/OUT with 1 safe power capable zone	PSHU20P300PTAAB0-P4
Internal	NPT	A	B	C	4-pin power IN/OUT with 1 safe power capable zone	PSHU20P300PTABC0-P4
Internal	NPT	A	A	N	4-pin power IN/OUT with 1 safe power capable zone	PSHU20P300PTAAN0-P4
Internal	NPT	A	A	A	5-pin power IN/OUT with 1 safe power capable zone	PSHU20P300PTAAA0-P5
Internal	NPT	A	A	B	5-pin power IN/OUT with 1 safe power capable zone	PSHU20P300PTAAB0-P5
Internal	NPT	A	A	C	5-pin power IN/OUT with 1 safe power capable zone	PSHU20P300PTAAC0-P5
Internal	NPT	A	A	N	5-pin power IN/OUT with 1 safe power capable zone	PSHU20P300PTAAN0-P5
Internal	NPT	A	A	A	4-pin power IN/IN with 2 safe power zones	PSHU20P300PTAAA0-S4
Internal	NPT	A	A	N	5-pin power IN/IN with 2 safe power zones	PSHU20P300PTAAN0-S5



For inventory, lead times, and kit lookup, visit www.pdnplu.com

D199

Parker Hannifin Corporation
 Pneumatic Division
 Richland, Michigan
www.parker.com/pneumatics

D

Subbase & Manual Valves

H Series Micro

Moduflex Series

H Series ISO

Network Connectivity

DX ISOMAX Series

Valvair II Series

End Plate Kit – Universal Plug-in

The PCH Network Portal is ordered as an endplate kit. This includes the PCH Network Portal, left hand air supply module, and right hand end plate.

For fully assembled manifold Add-A-Fold part number, reference page D88



PSHU20 P3 0 0 P E AAA 0 – P4

Valve Type	
Plug-in (Internal pilot)	PSHU20
Plug-in (External pilot)	PSHU2X

Thread Type	
NPT	0
BSPP "G"	1

Network Connections	
EtherNet/IP™	E
EtherCAT	T
PROFINET	N
Modbus TCP	M

Power Connector	
4-pin power IN/OUT with 1 safe power capable zone	P4
5-pin power IN/OUT with 1 safe power capable zone	P5
4-pin power IN/IN with 2 safe power zones	S4
5-pin power IN/IN with 2 safe power zones	S5

Right Hand End Plate Type / Thread Size	
Low profile (no ports)	0
1/2 Exhaust and inlet port	1
3/4 Exhaust and inlet port	2
H3 Transition plate and end plate (electrical pass through for plug-in valves only)	3
H3 Transition plate and end plate (expansion to 25th address for plug-in valves only)	4

Module Combinations		
Module Position 1	Module Position 2	Module Position 3
A	A	A
A	A	B
A	A	C
A	A	N
A	B	B
A	B	C
A	B	N
A	C	C
A	C	N
B	B	B
B	B	C
B	B	N
B	C	C
B	C	N
C	C	C
C	C	N

For any module configurations not listed, consult factory.

D	Subbase & Manual Valves
	H Series Micro
	Modulflex Series
	H Series ISO
	Network Connectivity
	DX ISOMAX Series
	Valvair II Series

Most popular.



For inventory, lead times, and kit lookup, visit www.pdnplu.com

Mechanical Data

Housing Material	Housing /Enclosure: PBT with 33% GF and UL94-V0 Base Cover (plate): Aluminum 380
Enclosure rating	IP 65 (only when plugged-in and threaded-in)
Power Connectors	7/8" 4 or 5 pin male and female pin connector
Input ports/ Output ports	M12, A-coded (12 x female)
Dimensions (L x B x H in mm)	226.6mm x 130.7mm x 55mm
Mounting type	Screw Mount
Ground strap attachment	M5
Weight	Approx. 1.3 kg

Operating Conditions

Operating Temperature	0°C to 50°C
Storage Temperature	-25°C to 70°C
CE as per	IEC 61000-6-2 (Industrial Immunity) IEC 61000-6-4 (Industrial Emission)
Shock/Vibrations	IEC 60068-2-27:2008 IEC 60068-2-6:2007
Electrostatic Discharge	IEC 61000-4-2
Electrical Fast Transient/ Burst	IEC 61000-4-4
Surge Immunity	IEC 61000-4-5

Electrical Data

Supply Voltage	24VDC (-15% to +20%)
Logic current at 24 V (V1)	Max Current 8A – Actual usage depends on configuration
Auxiliary current at 24 V (V2)	Max Current 12A – Actual usage depends on configuration

Valve Configuration

Compatible Valves	H Universal ISO Valves
Available addresses	24 addresses, 32 addresses with H Universal Extension Slice



For inventory, lead times, and kit lookup, visit www.pdnplu.com

D201

Parker Hannifin Corporation
Pneumatic Division
Richland, Michigan
www.parker.com/pneumatics

D

Subbase & Manual Valves

H Series Micro

Moduflex Series

H Series ISO



Network Connectivity

DX ISOMAX Series

Valvair II Series



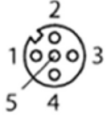

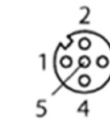
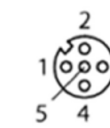



I/O Port Pin Outs

- The PCH Network Portal uses threaded M12 Ports for I/O Connections
- All configurable ports are configurable through software at any time

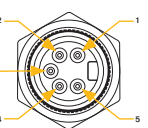
Module Variant	Connector	Pin No.	Function
A		1	+24V, 500mA VLOG (V1)
		2	Input (PNP or NPN) / Output +24V, 250 mA (V1)
		3	GND (V1)
		4	IO-Link/Input (PNP or NPN) / Output +24V, 250mA (V1)
		5	Not Connected
*Applies to ports 1-4 of this module			
B		1	+24V, 250mA VLOG (V1)
		2	+24V, 1.2A VAUX (V2)
		3	GND (V1)
		4	IO-Link/Input (PNP or NPN) / Output +24V, 250mA (V1)
		5	GND (V2)
*Applies to ports 1-4 of this module			
C		1	Not Connected
		2	Output +24VAUX (V2), 500mA
		3	GND (V2)
		4	Output +24VAUX (V2), 500mA
		5	Not Connected
*Applies to ports 1-2 of this module			
D		1	+24V, 250mA VLOG (V1)
		2	+24V, 1.2A VAUX (V2)
		3	GND (V1)
		4	IO-Link/Input (PNP or NPN) / Output +24V, 250mA (V1)
		5	GND (V2)
*Applies to ports 3-4 of this module			

Power Connector Pin Outs

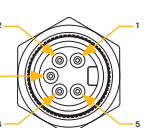
- The PCH Network Portal uses 7/8" ports for its left IN and right OUT or IN power connectors.
- Any power configuration below can be ordered
- For AIDA power connector, consult factory

	Left Power Connector: Power IN				Right Power Connector: Power OUT			
	Connector	Pin No.	Function	Description	Connector	Pin No.	Function	Description
P4		1	+24 V	V2 (VAUX), 12A		1	+24 V	V2 (VAUX), 3.8A
		2	+24 V	V1 (VLOG), 8A		2	+24 V	V1 (VLOG), 1.28A
		3	0 V	GND V1 (VLOG)		3	0 V	GND V1 (VLOG)
		4	0 V	GND V2 (VAUX)		4	0 V	GND V2 (VAUX)
P5		1	0 V	GND V2 (VAUX)		1	0 V	GND V2 (AUX)
		2	0 V	GND V1 (VLOG)		2	0 V	GND V1 (VLOG)
		3	Protective Earth	Protective Earth		3	Protective Earth	Protective Earth
		4	+24 V	V1 (VLOG), 8A		4	+24 V	V1 (VLOG)
		5	+24 V	V2 (VAUX), 12A		5	+24 V	V2 (VAUX)
S4		1	+24 V	V2 (VAUX), 12A		1	+24 V	V2 (VAUX), 3.8A
		2	+24 V	V1 (VLOG), 8A		2	+24 V	V1 (VAUX), 1.28A
		3	0 V	GND V1 (VLOG)		3	0 V	Safe GND 1-3*
		4	0 V	GND V2 (VAUX)		4	0 V	Safe GND 4*
S5		1	0 V	GND V2 (VAUX)		1	+24 V	V2 (VAUX), 3.8A
		2	0 V	GND V1 (VLOG)		2	+24 V	V1 (VAUX), 1.28A
		3	Protective Earth	Protective Earth		3	Protective Earth	Protective Earth
		4	+24 V	V1 (VLOG), 8A		4	0 V	Safe GND 1-3*
		5	+24 V	V2 (VAUX), 12A		5	0 V	Safe GND 4*

Safe GND 1-3 refers to solenoid addresses 0-23 and "Safe GND 4*" refers to solenoid addresses 24-31



For inventory, lead times, and kit lookup, visit www.pdnplu.com

D202

Parker Hannifin Corporation
 Pneumatic Division
 Richland, Michigan
www.parker.com/pneumatics

Subbase & Manual Valves

H Series Micro

Modulflex Series

H Series ISO

Network Connectivity

DX ISOMAX Series

Valvair II Series

Solenoid Addressing

- The PCH Network Portal can use the following H ISO Universal Valves:
 - ISO 15407-2 – sizes 02 & 01
 - ISO 5599-2 – sizes 1, 2 & 3
- The PCH Network Portal can support up to 32 addresses as shown
- The data map and PCH Tool refers to each address with a Valve_X designator. Each Valve_X designator is as shown.
- Addresses 25-31 can be accessed using an Intermediate Air Supply with Electric Expansion
- Each address is one solenoid

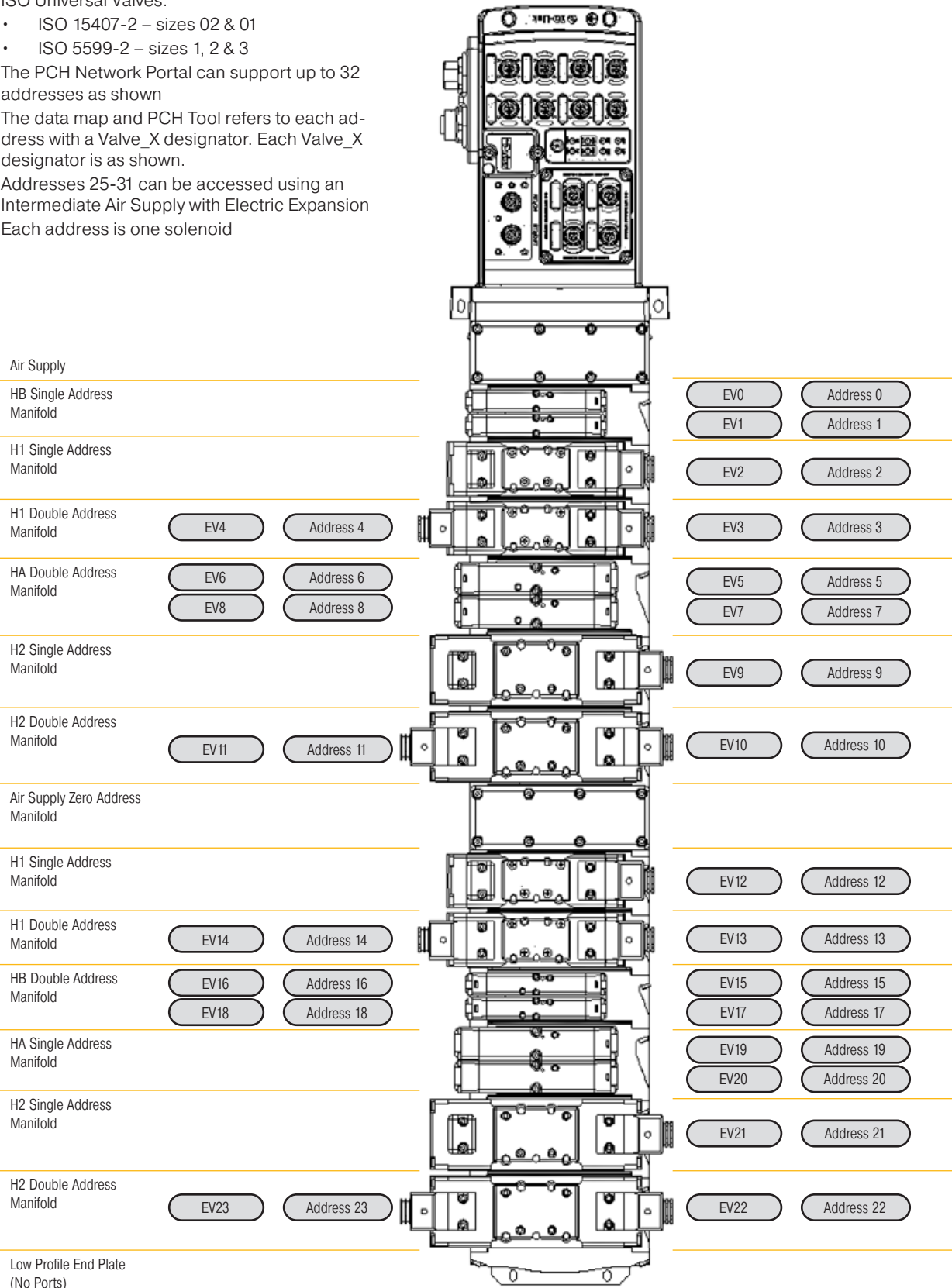

D

Subbase & Manual Valves

H Series Micro

Modulflex Series

H Series ISO

Network Connectivity

DX ISOMAX Series

Valvair II Series



For inventory, lead times, and kit lookup, visit www.pdnplu.com

D203

Parker Hannifin Corporation
 Pneumatic Division
 Richland, Michigan
www.parker.com/pneumatics

PCH Network Portal with H Series ISO Valves

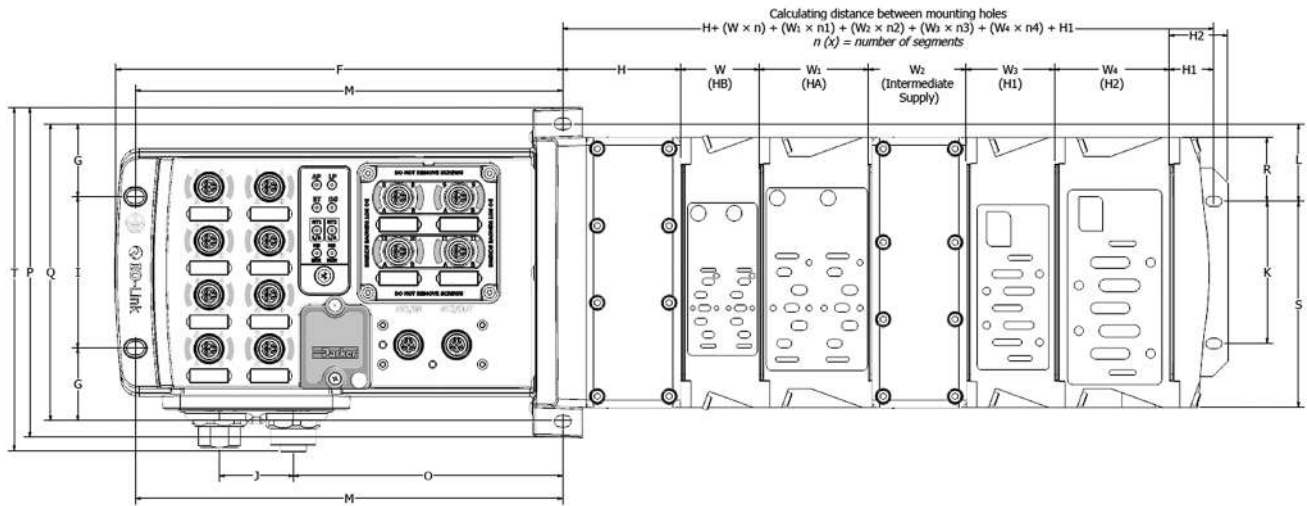

n (x) = number of segments

A	B	C	D	E	F	G	H	H1	H2	J	K	L
4.42 (112.3)	2.64 (67.1)	2.46 (62.5)	1.17 (29.7)	.55 (14)	9.32 (236.7)	1.51 (38.4)	2.36 (59.9)	.9 (22.9)	1.22 (31)	1.55 (39.4)	2.95 (74.9)	1.6 (40.6)
M	O	P	Q	R	S	T	W	W1	W2	W3	W4	
8.91 (226.3)	5.61 (142.5)	6.86 (174.2)	6.18 (157)	1.33 (33.8)	4.28 (108.7)	7.14 (181.4)	1.63 (41.4)	2.28 (57.9)	2.03 (51.6)	1.82 (46.2)	2.39 (60.7)	

Inches (mm)

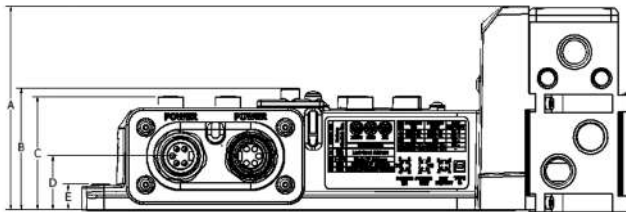

- D**
- Subbase & Manual Valves
- H Series Micro
- Modulflex Series
- H Series ISO
- Network Connectivity
- DX ISOMAX Series
- Valvair II Series



For inventory, lead times, and kit lookup, visit www.pdnplu.com

D204

Parker Hannifin Corporation
Pneumatic Division
Richland, Michigan
www.parker.com/pneumatics

Product Support

- The PCH Network Portal Product Landing page can be accessed at the following:



www.parker.com/pdn/PCHPortal

- The PCH Network Portal support material can be accessed at the following:



www.parker.com/pdn/networkconnectivity

- The PCH Connect - Bluetooth App



User Manuals

- The PCH Network Portal User Manuals can be accessed at the following website. Click on QR code for hyperlink.

EtherNet/IP™ EtherNet/IP™ User Manual



Profinet User Manual

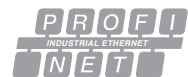

EtherCAT® EtherCAT User Manual



Modbus User Manual



For more information on IO-link

 www.io-link.com

D	Subbase & Manual Valves
H Series Micro	Moduflex Series
H Series ISO	Network Connectivity
DX ISOMAX Series	Valvair II Series



Features

The Turck Network Portal

Turck Network Portal has four major components:

- **Valve Driver Module** provide control for either 16 or 32 solenoids on a manifold
- **I/O Modules** provide the field interface and system-interface circuitry
- **Communication Modules** provide the network-interface circuitry
- **Power Distribution Module** provide 5 additional power inputs to the Turck system

H Series ISO & Network Connectivity Turck Network Portal

Turck Features

- Highly modular design (4pt – 16pt modularity)
- Broad application coverage
- Expandable 4 port Class A IO-Link master
- Channel-level diagnostics (LED and electronic)
- Channel-level alarm and annunciation (electronic)
- Channel-level open-wire detection with electronic feedback
- Channel-level short-circuit detection with electronic feedback
- Horizontal and vertical mounting without derating
- 5g vibration
- Electronic and mechanical keying
- Robust backplane design
- Quick-disconnects for I/O and network connectivity
- Built-in panel grounding
- Color-coded module labels
- UL, cCSAus, and CE certifications (as marked)
- Highly reliable structural integrity
- Optical isolation between field and system circuits

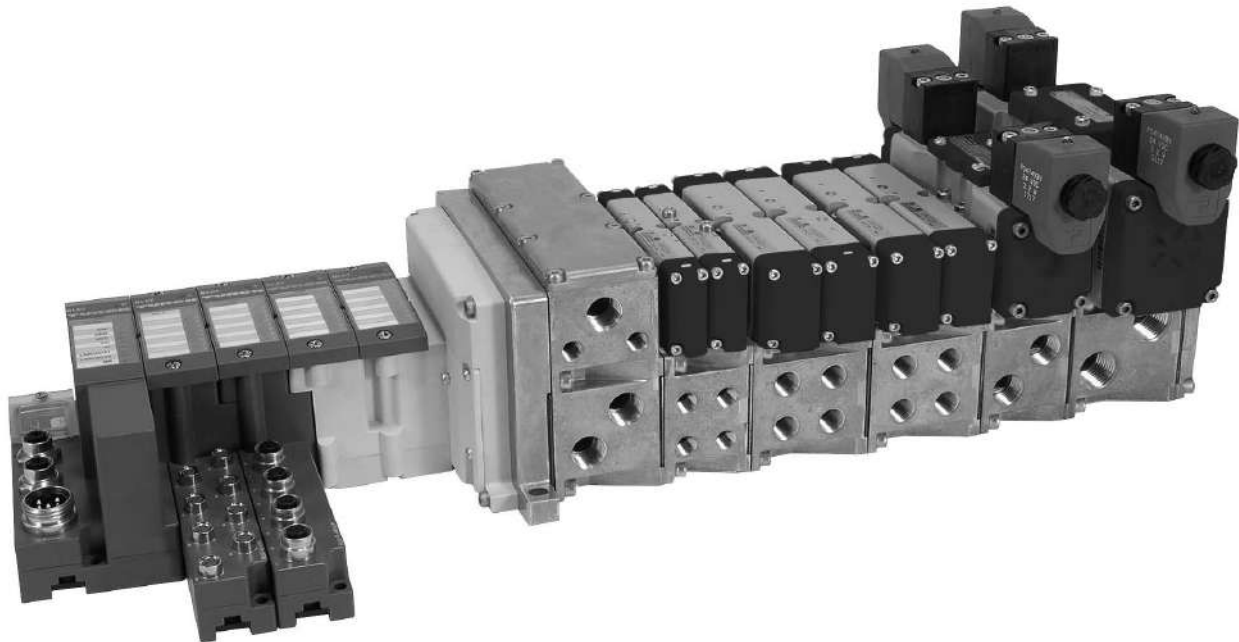

D

Subbase & Manual
Valves

H Series
Micro

Modulflex
Series

H Series
ISO

Network
Connectivity

DX ISOMAX
Series

Valvair II
Series



For inventory, lead times, and kit lookup, visit www.pdnplu.com

D206

Parker Hannifin Corporation
Pneumatic Division
Richland, Michigan
www.parker.com/pneumatics

Turk Network Portal

- A complete network communication offering for all H Series ISO and H Series Micro valves
- CSA, cULus and CE certifications (as marked)

I/O Configuration

- Centralized Turk Network Portal
- Pneumatics and I/O are in close proximity with one another
- M23, 12-Pin or 19-Pin output extension to an additional H Series valve manifold
- I/O density per module = 4, 8 or 16

EtherNet/IP™

DeviceNet

PROFI®
 PROCESS FIELD BUS

PROFI®
 INDUSTRIAL ETHERNET

Modbus/TCP™

CANopen

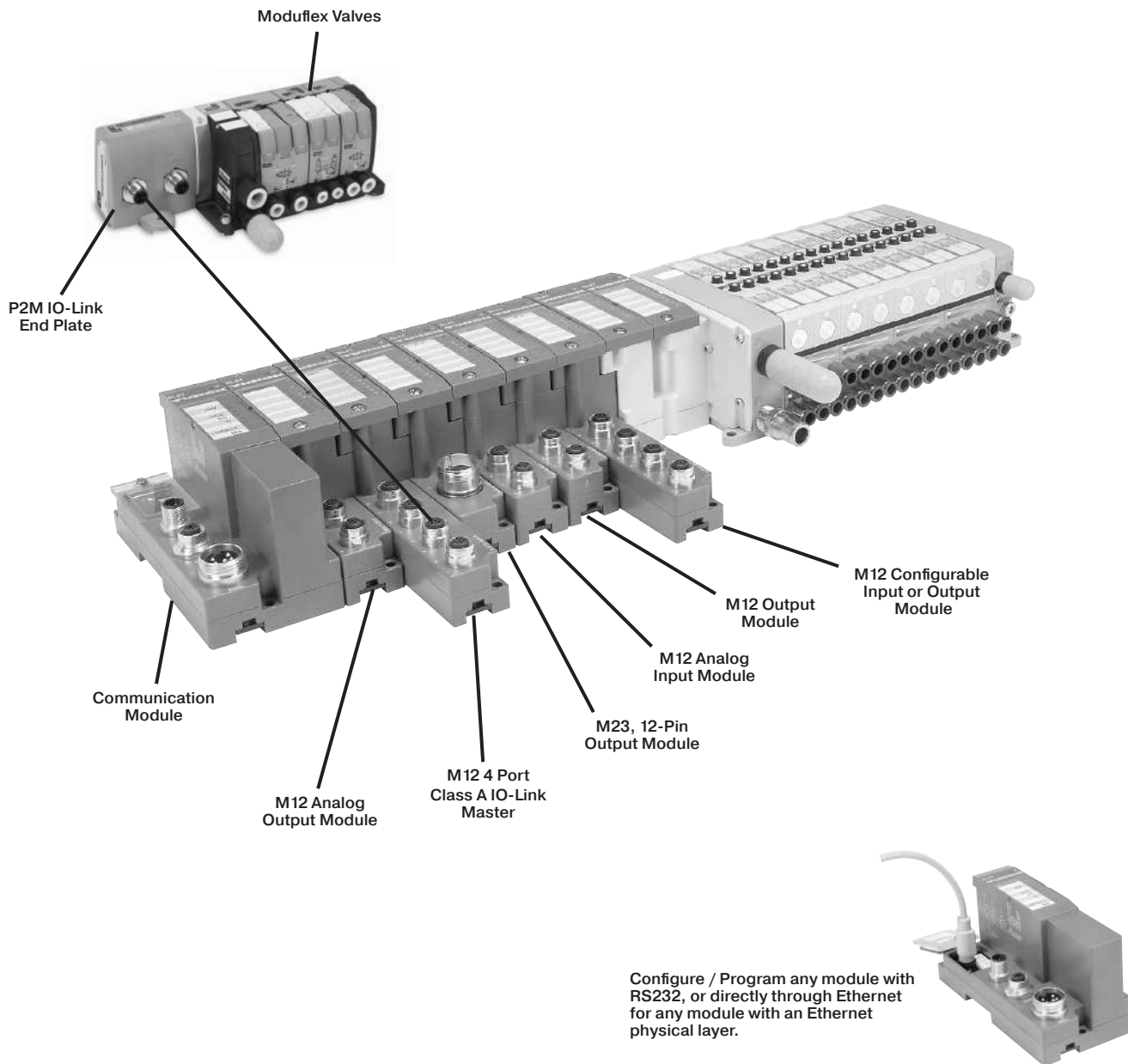

Configure / Program any module with RS232, or directly through Ethernet for any module with an Ethernet physical layer.

D	Subbase & Manual Valves
H Series Micro	Moduflex Series
H Series ISO	Network Connectivity
DX ISOMAX Series	Valvair II Series

Turk Network Portal

- A complete network communication offering for all H Series ISO and H Series Micro valves.
- CSA, cCSAus and CE certifications (as marked).

I/O Configuration

- Complete control of all I/O and valves with stand alone control
- Additional I/O and valves connected over DeviceNet with BL Remote Subnet
- BL Remote connection to P2M and Turk DeviceNet equipped communication modules
- I/O density per module = 4, 8 or 16

EtherNet/IP™

DeviceNet

PROFIBUS
PROCESS FIELD BUS

PROFIBUS
INDUSTRIAL ETHERNET

Modbus/TCP™

CANopen

D
Subbase & Manual Valves
H Series Micro
Modulflex Series
H Series ISO
Network Connectivity
DX ISOMAX Series
Valvair II Series

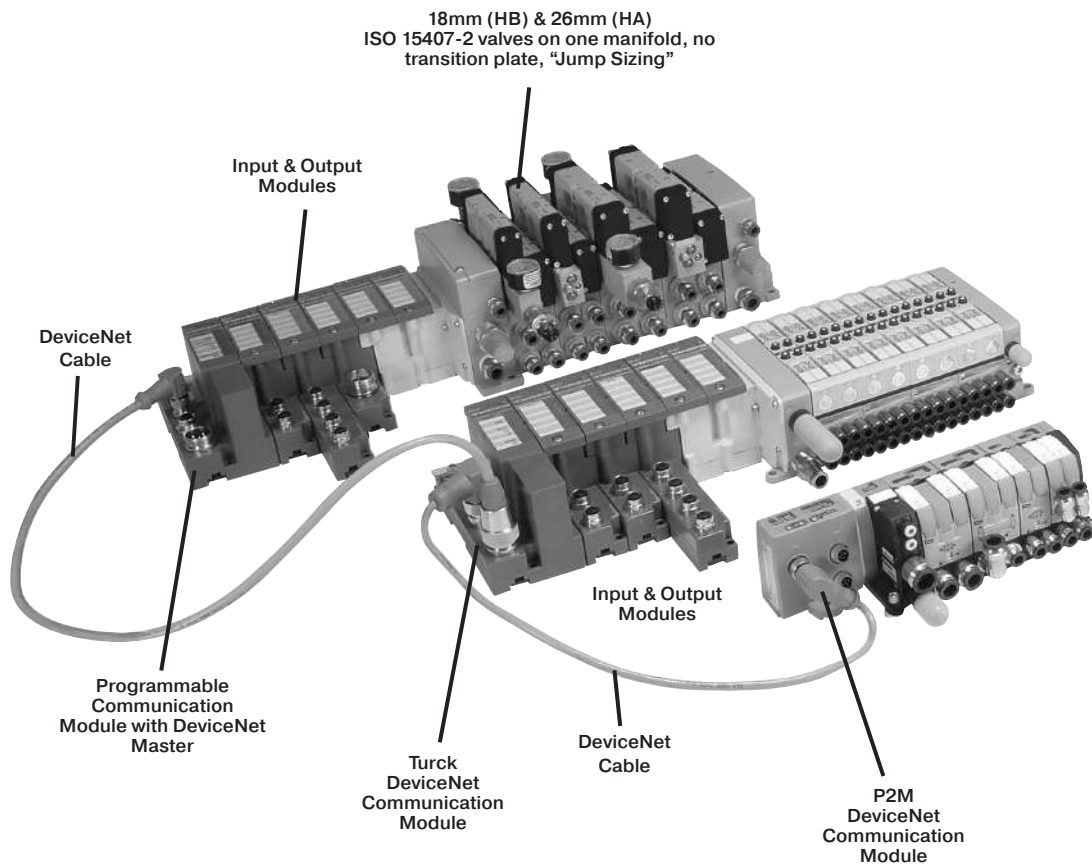

For inventory, lead times, and kit lookup, visit www.pdnplu.com

D208

Parker Hannifin Corporation
 Pneumatic Division
 Richland, Michigan
www.parker.com/pneumatics

Communications Module

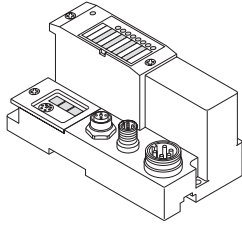

BL67 communication modules are the heart of a BL67 station. They are designed to connect the modular nodes to the higher level network (PROFIBUS-DP, DeviceNet, CANopen, Ethernet).

All BL67 electronic modules communicate over the internal module bus with the communication modules. The communication module structures the data and sends them clustered via network nodes to the higher control system.

This way all I/O modules can be configured independently of the system.

Electronic Module

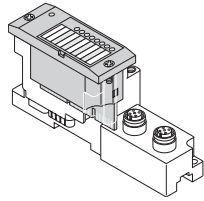

BL67 electronic modules are inserted into the passive base modules from above and then simply affixed with two screws. Maintenance is extremely simplified due to the separation of connection level and module electronics.

Moreover, flexibility is enhanced because the base modules provide different types of connectors. Voltage supply for the electronic modules is either provided via the communication modules or a Power Extender module. Power Extender modules can be used to create galvanically isolated potential groups.

Base Module

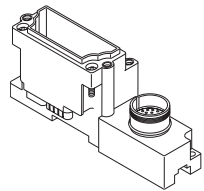

BL67 base modules are aligned one by one to the right of the communication module and are tightened each with two screws, either with the communication modules or with the previous module. A DIN rail is not required. This way a compact and stable unit is created which can be mounted directly on the machine.

The base modules serve for connection of the field devices and are available with different connection types (M8, M12, M23 and 7/8).

A BL67 system can be extended to a total length of 1 m, comprising of a communication module for PROFIBUS-DP, DeviceNet / CANopen or Ethernet and a maximum of 32 modules.

System supply: The power supply for the BL67 system is either derived separately for Profibus-DP and Ethernet communication modules or directly from the DeviceNet / CANopen cable for the DeviceNet / CANopen communication module.

Power Extender modules can be inserted anywhere in the BL67 station. They provide isolated field voltage for the I/O modules mounted to their right.

Thus Power Extender modules can also be used to create different potential groups.

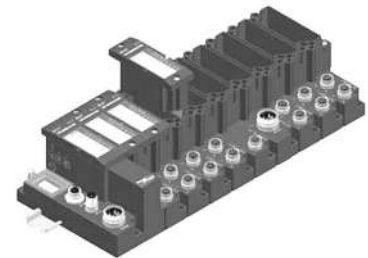

Maximum System Extension

Module type		PROFIBUS		DeviceNet		CANopen		ModbusTCP		EtherNet/IP		PROFIBUS NET	
		chan.	mod.	chan.	mod.	chan.	mod.	chan.	mod.	chan.	mod.	chan.	mod.
Digital inputs	4 DI	128	32	128	32	128	32	128	32	128	32	128	32
	8 DI	256	32	256	32	256	32	256	32	256	32	256	32
Digital outputs	4 DO	128	32	128	32	128	32	128	32	128	32	128	32
	8 DO	256	32	256	32	256	32	256	32	256	32	256	32
	16 DO	512	32	512	32	512	32	512	32	512	32	512	32
Analog inputs	2AI	64	32	64	32	64	32	64	32	64	32	64	32
	4AI	112	28	124	31	124	31	128	32	128	32	128	32
	2 AI-PT	56	28	64	32	64	32	64	32	64	32	64	32
	2 AI-TC	64	32	64	32	64	32	64	32	64	32	64	32
Analog outputs	2 AO-I	38	19	64	32	64	32	64	32	64	32	64	32
	2 AO-V	38	19	50	25	50	25	50	25	50	25	50	25



For inventory, lead times, and kit lookup, visit www.pdnplu.com

D209

Parker Hannifin Corporation
 Pneumatic Division
 Richland, Michigan
www.parker.com/pneumatics

D

Subbase & Manual Valves

H Series Micro

Moduflex Series

H Series ISO

Network Connectivity

DX ISOMAX Series

Valvair II Series

BL67-GW-DN

DeviceNet Communication Module with Power Over the Network



7/8 Mini bus in wiring, view into male connector

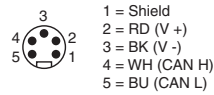

7/8 Mini bus out wiring, view into female connector

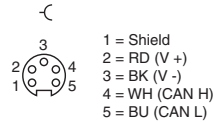

Turck Network Portal with up to 256 inputs, outputs, and 32 solenoids per H Series Micro or H Series ISO manifold. Digital inputs / outputs, analog inputs / outputs, serial interface, and counter modules are available. DeviceNet communication speeds selectable between 120, 250, 500 kbps, and CANopen communication speeds are selectable between 10 kbps up to 1 Mbps. Addressing for either module can be selected via rotary switches or set through software.

With the Power over the Network feature, it is only necessary to connect one cable to the communication module. For networks requiring additional power, a Bus Power Tee can be installed to combine separate network and power feeds into the communication module. See the Cables and Cordsets section for additional information.

BL67-GW-DPV1

Profibus Communication Module



M12 B-code bus out Wiring, view into female connector

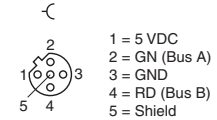

M12 B-code bus In Wiring, view into male connector

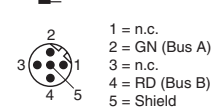

7/8 Mini Power in wiring, view into male connector

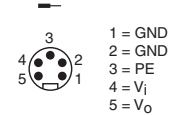

Turck Network Portal with up to 256 inputs, outputs, and 32 solenoids per H Series Micro or H Series ISO manifold. Digital inputs / outputs, analog inputs / outputs, serial interface, and counter modules are available. PROFIBUS communication speeds are selectable between 9.6 kbps up to 12 Mbps, and addressing can be selected via rotary switches or set through software.

BL67-GW-CO

CANopen Communication Module



M12 A-code bus out Wiring, view into female connector

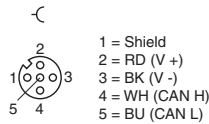

M12 A-code bus In Wiring, view into male connector

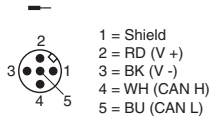

7/8 Mini Power in wiring, view into male connector

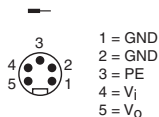

Turck Network Portal with up to 256 inputs, outputs, and 32 solenoids per H Series Micro or H Series ISO manifold. Digital inputs / outputs, analog inputs / outputs, serial interface, and counter modules are available. CANopen communication speeds are selectable between 10 kbps up to 1 Mbps, and addressing can be selected via rotary switches or set through software.

BL67-GW-EN

Modbus/TCP, EtherNet/IP™, and ProfiNet

BL67-GW-EN-PN

PROFINET Communication Module



M12 D-code Ethernet in Wiring, view into female connector

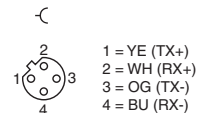

7/8 Mini Power in wiring, view into male connector

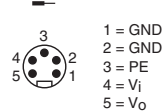

Turck Network Portal with up to 256 inputs, outputs, and 32 solenoids per H Series Micro or H Series ISO manifold. Digital inputs / outputs, analog inputs / outputs, serial interface, and counter modules are available. Communication speeds of 10/100 Mbps, and addressing can be selected via rotary switches, BOOTP, DHCP, or through software.

D	Subbase & Manual
H Series Micro	Valves
H Series ISO	Modulflex Series
Network Connectivity	DX ISOMAX Series
Valvair II Series	



For inventory, lead times, and kit lookup, visit www.pdnplu.com

BL67-GW-EN-DN

Modbus/TCP Communication Module with DeviceNet Subnet

BL67-GW-EN-IP-DN

EtherNet/IP™ Communication Module with DeviceNet Subnet



DeviceNet OUT

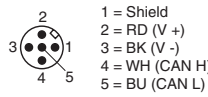

M12 D-code Ethernet in Wiring, view into female connector

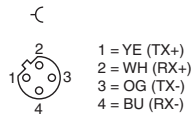

7/8 Mini Power in wiring, view into male connector

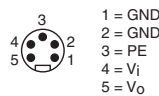

With BL Remote DeviceNet subnet functionality, each communication module has its own DeviceNet master which provides a connection for 63 DeviceNet nodes with additional inputs, outputs, and solenoid control. BL Remote DeviceNet subnet is independent of the main network, and is not visible to the master PLC.

BL67-PG-EN-DN

Modbus/TCP Programmable Communication Module with DeviceNet Subnet

BL67-PG-EN-IP-DN

EtherNet/IP™ Programmable Communication Module with DeviceNet Subnet



DeviceNet OUT

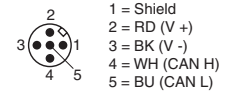

M12 D-code Ethernet in Wiring, view into female connector

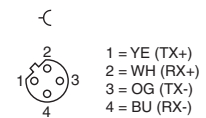

7/8 Mini Power in wiring, view into male connector

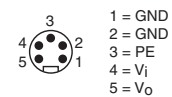

Communication modules are equipped with a built in standalone controller which is programmed according to IEC61131-3 with CoDeSys. Each module has 512KB Program memory with 32 bit RISC processor, and can run 1000 instructions in less than 1 ms. These network equipped modules are optimized to interface with PLC's with network capability or act as standalone controllers that need to interface with other network equipped devices.

With BL Remote DeviceNet subnet functionality, each communication module has its own DeviceNet master which provides a connection for 63 DeviceNet nodes with additional inputs, outputs, and solenoid control. BL Remote DeviceNet subnet is independent of the main network, and is not visible to the master PLC.

BL67-PG-DP

PROFIBUS Programmable Communication Module

BL67-PG-EN

Modbus/TCP Programmable Communication Module

BL67-PG-EN-IP

EtherNet/IP™ Programmable Communication Module



Profibus Wiring

M12 B-code bus out Wiring, view into female connector

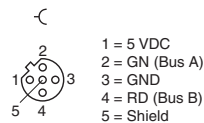

M12 B-code bus in Wiring, view into female connector

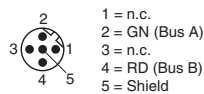

Ethernet Wiring

M12 D-code Ethernet in Wiring, view into female connector

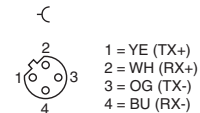

7/8 Mini Power in wiring, view into male connector Common to modules

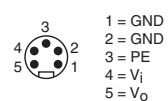

Communication modules are equipped with a built in standalone controller which is programmed according to IEC61131-3 with CoDeSys. Each module has 512KB Program memory with 32 bit RISC processor, and can run 1000 instructions in less than 1 ms. These network equipped modules are optimized to interface with PLC's with network capability or act as standalone controllers that need to interface with other network equipped devices.



For inventory, lead times, and kit lookup, visit www.pdnplu.com

D211

Parker Hannifin Corporation
 Pneumatic Division
 Richland, Michigan
www.parker.com/pneumatics

D

Subbase & Manual Valves

H Series Micro

Modulflex Series

H Series ISO

Network Connectivity

DX ISOMAX Series

Valvair II Series

D
 Subbase & Manual Valves
 H Series Micro
 Modulflex Series
 H Series ISO
 Network Connectivity
 DX ISOMAX Series
 Valvair II Series

Base Modules													
	BL67-B-4M8	BL67-B-8M8	BL67-B-1M12	BL67-B-1M12-8	BL67-B-2M12	BL67-B-2M12-P	BL67-B-4M12	BL67-B-4M12-P	BL67-B-1M23	BL67-B-1M23-19	BL67-B-1RSM	BL67-B-1RSM-4	BL67-1RSM-VO
Power Extender Modules													
BL67-PF-24VDC											✓	✓	✓
Digital Input Modules													
BL67-4DI-P	✓				✓	✓	✓		✓				
BL67-8DI-P		✓					✓	✓	✓				
BL67-4DI-PD	✓				✓	✓	✓		✓				
BL67-8DI-PD		✓					✓	✓	✓				
BL67-4DI-N	✓				✓	✓	✓		✓				
BL67-8DI-N		✓					✓	✓	✓				
Digital Output Modules													
BL67-4DO-0.5A-P	✓				✓	✓	✓		✓				
BL67-4DO-2A-P	✓				✓	✓	✓		✓				
BL67-8DO-0.5A-P		✓					✓	✓	✓				
BL67-16DO-0.1A-P										✓			
BL67-4DO-2A-N	✓				✓	✓	✓		✓				
BL67-8DO-0.5A-N		✓					✓	✓	✓				
Relay Output Modules													
BL67-8DO-R-NO								✓					
Digital Input / Output Modules													
BL67-4DI4DO-PD		✓					✓	✓	✓				
Configurable Digital Input / Output Modules													
BL67-8XSG-PD		✓					✓	✓	✓				
Analog Input Modules													
BL67-2AI-I					✓								
BL67-2AI-V					✓								
BL67-4AI-V/I							✓						
BL67-2AI-PT					✓								
BL67-2AI-TC					✓								
Analog Output Modules													
BL67-2AO-I					✓								
BL67-2AO-V					✓								
Technology Modules													
BL67-1RS232			✓	✓					✓				
BL67-1RS485/422			✓	✓					✓				
BL67-1SSI				✓					✓				
BL67-1CNT/ENC				✓					✓				
BL67-1CVI			✓										
BL Ident® RFID Modules													
BL67-2RFID-A					✓								
BL67-2RFID-S					✓								



For inventory, lead times, and kit lookup, visit www.pdnplu.com

D212

Parker Hannifin Corporation
 Pneumatic Division
 Richland, Michigan
www.parker.com/pneumatics

System Supply via the Module Bus

The number of BL67 modules that can be powered by the communication module, depends on the nominal current draw of all the modules in the system. The total bus power current consumption of the installed BL67 modules may not exceed 1.5 A. The total field power current for inputs may not exceed 4 A, and the total field power for outputs may not exceed 8 A for DeviceNet and CANopen with power over the network, or 10A for all other communication modules.

When using the software PACTware, the menu item <Station - Verify> will automatically generate an error message if the system supply via the module bus is not reliably ensured.

Nominal Current Consumption

The following table shows the nominal current consumption of the various BL67 modules:

Modules	Bus Power Current (mA)	Field Power for Inputs ¹⁾ (mA)	Field Power for Outputs (mA)
PROFIBUS-DP communication module	0		150
DeviceNet communication module	0		150
CANopen communication module	0		150
Ethernet communication module	0		150
Valve driver with 16 outputs	30		< 109 mA (plus load current)
Valve driver with 32 outputs	60		< 218 mA (plus load current)
BL67-PF-24VDC	30		9
BL67-4DI-P	30	< 49 mA	
BL67-4DI-N	30	< 10 mA	
BL67-4DI-PD	30	< 109 mA	
BL67-8DI-P	30	< 49 mA	
BL67-8DI-N	30	< 10 mA	
BL67-8-DI-PD	30	< 109 mA	
BL67-4DO-0.5A-P	30		< 109 mA (plus load current)
BL67-4DO-2A-P	30		< 109 mA (plus load current)
BL67-4DO-2A-N	30		< 109 mA (plus load current)
BL67-8DO-0.5A-P	30		< 109 mA (plus load current)
BL67-8DO-0.5A-N	30		< 109 mA (plus load current)
BL67-16DO-0.1A-P	30		< 109 mA (plus load current)
BL67-4DI4DO-PD	30		< 109 mA (plus load current)
BL67-8XSG-PD	30		< 109 mA (plus load current)
BL67-8DO-R-NO	30		< 109 mA (plus load current)
BL67-2AI-V	35	< 22 mA	
BL67-2AI-I	35	< 22 mA	
BL67-4AI-I/V	35	< 22 mA	
BL67-2AI-TC	35	< 40 mA	
BL67-2AI-PT	45	< 58 mA	
BL67-2AO-I	40		< 62 mA
BL67-2AO-V	60		< 67 mA
BL67-1RS232	140	< 90 mA	
BL67-1RS485/422	60	< 42 mA	
BL67-1SSI	50	< 39 mA	
BL67-1CNT/ENC	30	< 109 mA	
BL67-1CVI	30	< 109 mA	

1) Is limited to 4A by means of the integrated short-circuit protection.

D

Subbase & Manual Valves

H Series Micro

Modulflex Series

H Series ISO

Network Connectivity

DX ISOMAX Series





Valvair II Series







For inventory, lead times, and kit lookup, visit www.pdnplu.com

Digital Input Modules

I/O Modules	Voltage	Part Number
 8 PNP input module	7 to 30 VDC	BL67-8DI-P
8 PNP input module, with diagnostics	7 to 30 VDC	BL67-8DI-PD
8 NPN input module	24 VDC	BL67-8DI-N





Base Module	Part Number
 8 x M8, 3 pole, female	BL67-B-8M8
 4 x M12, 5 pole, female, A-code	BL67-B-4M12
 4 x M12, 5 pole, female, A-code	BL67-B-4M12-P
 1 x M23, 12 pole, female	BL67-B-1M23

I/O Modules	Voltage	Part Number
4 PNP input module	7 to 30 VDC	BL67-4DI-P
4 PNP input module, with diagnostics	7 to 30 VDC	BL67-4DI-PD
4 NPN input module	24 VDC	BL67-4DI-N





Base Module	Part Number
 4 x M8, 3 pole, female	BL67-B-4M8
 2 x M12, 5 pole, female, A-code	BL67-B-2M12
 2 x M12, 5 pole, female, A-code	BL67-B-2M12-P
 4 x M12, 5 pole, female, A-code	BL67-B-4M12
 1 x M23, 12 pole, female	BL67-B-1M23

Digital Output Modules

I/O Modules	Output Current	Part Number
 8 PNP output module	0.5 amps per channel	BL67-8DO-0.5A-P
8 NPN output module	0.5 amps per channel	BL67-8DO-0.5A-N

Base Module	Part Number
 8 x M8, 3 pole, female	BL67-B-8M8
 4 x M12, 5 pole, female, A-code	BL67-B-4M12
 4 x M12, 5 pole, female, A-code	BL67-B-4M12-P
 1 x M23, 12 pole, female	BL67-B-1M23

I/O Modules	Output Current	Part Number
4 PNP output module	0.5 amps per channel	BL67-4DO-0.5A-P
4 PNP output module	2 amps per channel	BL67-4DO-2A-P
4 PNP output module	4 amps per channel	BL67-4DO-4A-P
4 NPN output module	2 amps per channel	BL67-4DO-2A-N

Base Module	Part Number
 4 x M8, 3 pole, female	BL67-B-4M8
 2 x M12, 5 pole, female, A-code	BL67-B-2M12
 2 x M12, 5 pole, female, A-code	BL67-B-2M12-P
 4 x M12, 5 pole, female, A-code	BL67-B-4M12
 1 x M23, 12 pole, female	BL67-B-1M23

 Most popular.



For inventory, lead times, and kit lookup, visit www.pdnplu.com

D

Subbase & Manual Valves

H Series Micro

Modulflex Series

H Series ISO

Network Connectivity

DX ISOMAX Series

Valvair II Series

Digital Output Modules

I/O Modules	Output Current	Part Number
16 PNP output module	0.14 amps per channel	BL67-16DO-0.1A-P

Base Module	Part Number
 1 x M23, 19 pole, female	BL67-B-1M23-19

Relay Output Modules

I/O Modules	Output Current	Part Number
8 normally open relays	0.14 amps per channel	BL67-8DO-R-NO

Base Module	Part Number
 4 x M12, 5 pole, female, A-code	BL67-B-4M12-P

Analog Input Modules

I/O Modules	Input Type	Part Number
4 configurable current or voltage analog input module	4 to 20 mA or 0 to 20 mA -10 to +10 VDC or 0 to +10 VDC	BL67-4AI-V/I

Base Module	Part Number
 4 x M12, 5 pole, female, A-code	BL67-B-4M12

I/O Modules	Input Type	Part Number
2 current analog input module	4 to 20 mA or 0 to 20 mA	BL67-2AI-I
2 voltage analog input module	-10 to +10 VDC or 0 to +10 VDC	BL67-2AI-V
2 temperature analog input module	PT100, PT200, PT500, PT1000, Ni100, Ni1000	BL67-2AI-PT
2 temperature analog input module	Type B, E, J, K, N R, S, T	BL67-2AI-TC

Base Module	Part Number
 2 x M12, 5 pole, female, A-code	BL67-B-2M12

 Most popular.

Combination Input / Output Modules

I/O Modules	Input Voltage & Output Current	Part Number
4 PNP output 4 PNP input module, with diagnostics	7 to 30 VDC 0.5 Amps	BL67-4DI4DO-PD
8 PNP configurable input or output module, with diagnostics	7 to 30 VDC 0.5 Amps	BL67-8XSG-PD

Base Module	Part Number
-------------	-------------

 8 x M8, 3 pole, female	BL67-B-8M8
--	-------------------

 4 x M12, 5 pole, female, A-code	BL67-B-4M12
---	--------------------

 4 x M12, 5 pole, female, A-code	BL67-B-4M12-P
---	----------------------

Analog Output Modules

I/O Modules	Input Type	Part Number
4 voltage analog output module	-10 to +10 VDC or 0 to +10 VDC	BL67-4AO-V

Base Module	Part Number
-------------	-------------

 4 x M12, 5 pole, female, A-code	BL67-B-4M12
---	--------------------

I/O Modules	Input Type	Part Number
2 current analog output module	4 to 20 mA or 0 to 20 mA	BL67-2AO-I
2 voltage analog output module	-10 to +10 VDC or 0 to +10 VDC	BL67-2AO-V

Base Module	Part Number
-------------	-------------

 2 x M12, 5 pole, female, A-code	BL67-B-2M12
---	--------------------



For inventory, lead times, and kit lookup, visit www.pdnplu.com

D215

Parker Hannifin Corporation
 Pneumatic Division
 Richland, Michigan
www.parker.com/pneumatics

D

Subbase & Manual Valves

H Series Micro

Moduflex Series

H Series ISO



Network Connectivity

DX ISOMAX Series

Valvair II Series

Combination Analog Input / Output Modules

I/O Modules	Output Current	Part Number
4 configurable input and 4 configurable output current or voltage analog module	4 to 20 mA or 0 to 20 mA -10 to +10 VDC or 0 to +10 VDC	BL67-4AI4AO-V/I

Base Module	Part Number
 8 x M8, 3 pole, female	BL67-B-8M8
 4 x M12, 5 pole, female, A-code	BL67-B-4M12

CANopen Subnet Module

Extender Module	Capacity	Part Number
1 CANopen connection	64 bits of inputs or outputs	BL67-1CVI

Base Module	Part Number
 1 x M12, 5 pole, female, A-code	BL67-B-1M12



IO-Link Class A Master

Extender Module	Part Number
4 master channels	BL67-4IOL

Base Module	Part Number
 4 x M12, 5 pole, female, A-code	BL67-B-4M12

Power Extender Module

Extender Module	Current Capacity	Part Number
24 VDC field power module	10 amps input	BL67-PF-24VDC

Base Module	Part Number
 5 pole mini connector to supply bus power and field power	BL67-B-1RSM
 5 pole mini connector to field power only	BL67-B-1RSM-VO
 4 pole mini connector to supply bus power and field power	BL67-B-1RSM-4



 Most popular.

I/O Modules	Output Current	Part Number
2 configurable input and 2 configurable output current or voltage analog module	4 to 20 mA or 0 to 20 mA -10 to +10 VDC or 0 to +10 VDC	BL67-2AI2AO-V/I

Base Module	Part Number
 8 x M8, 3 pole, female	BL67-B-8M8



Serial Interface Module

Extender Module	Capacity	Part Number
1 RS232 serial interface	300 to 115200 bps	BL67-1RS232
1 RS485 or 422 serial interface	300 to 115200 bps	BL67-1RS485/422

Base Module	Part Number
 1 x M12, 5 pole, female, A-code	BL67-B-1M12
 1 x M12, 8 pole, female, A-code	BL67-B-1M12-8
 1 x M23, 12 pole, female	BL67-B-1M23

SSI and Counting Modules

Extender Module	Capacity	Part Number
1 SSI sensor interface	65 kbps up to 1 Mbps	BL67-1SSI
1 counter interface	Up to 250 kHz	BL67-1CNT/ENC

Base Module	Part Number
 1 x M12, 8 pole, female, A-code	BL67-B-1M12-8
 1 x M23, 12 pole, female	BL67-B-1M23

D
 Subbase & Manual Valves
 H Series Micro
 Modflex Series
 H Series ISO
 Network Connectivity
 DX ISOMAX Series
 Valvair II Series



For inventory, lead times, and kit lookup, visit www.pdnplu.com

Digital PNP Input Modules

DC Input Module	BL67-4DI-P	BL67-8DI-P	BL67-4DI-PD	BL67-8DI-PD
Number of inputs	4	8	4	8
Sensor requirement	PNP Sourcing		PNP Sourcing	
Voltage, on-state input, nom.	24 VDC		24 VDC	
Field power for inputs current consumption	49 mA		109 mA	
Bus power current consumption	30 mA		30 mA	
Low level signal voltage	<4.5 V		<4.5 V	
High level signal voltage	7...30V		7...30V	
Low level signal current	<1.5 mA		<1.5 mA	
High level signal current	2.1...3.7 mA		2.1...3.7 mA	
Type of diagnostics	Group Diagnostics		Channel Diagnostics	
Short circuit protection	Group Protection		Channel Protection	
Input delay	0.25 ms		0.25; 2.5 ms	

PNP (Sourcing)

PNP input modules provide sourcing capabilities. When the input field device is passing, current flows from the input device into the Turck input module.

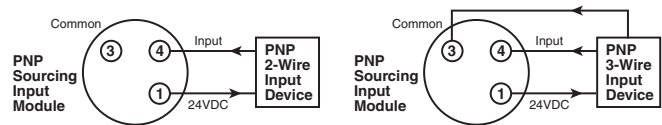

Digital NPN Input Modules

Digital DC Input Module	BL67-4DI-N	BL67-8DI-N
Number of inputs	4	8
Sensor requirement	NPN Sinking	NPN Sinking
Voltage, on-state input, nom.	24 VDC	24 VDC
Field power for inputs current consumption	10 mA	10 mA
Bus power current consumption	30 mA	30 mA
Low level signal voltage	>7 V	>7 V
High level signal voltage	<5 V	<5 V
Low level signal current	<2.5 mA	<1.2 mA
High level signal current	>3 mA	>1.5 mA
Type of diagnostics	Group Diagnostics	Group Diagnostics
Short circuit protection	Group Protection	Group Protection
Input delay	0.25 ms	0.25 ms

NPN (Sinking)

NPN input modules provide sinking capabilities. When the input field device is passing, current out of the Turck input module into the field input device.

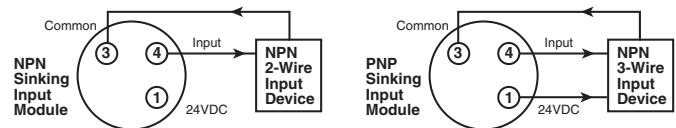

For inventory, lead times, and kit lookup, visit www.pdnplu.com

D217

Parker Hannifin Corporation
 Pneumatic Division
 Richland, Michigan
www.parker.com/pneumatics

D

Subbase & Manual Valves

H Series Micro

Moduflex Series

H Series ISO

Network Connectivity

DX ISOMAX Series

Valvair II Series

Digital PNP Output Modules

Digital DC Output Module	BL67-4DO-0.5A-P	BL67-8DO-0.5A-P	BL67-4DO-2A-P	BL67-16DO-0.1A-P
Number of outputs	4	8	4	16
Sensor requirement	PNP Sourcing	PNP Sourcing	PNP Sourcing	PNP Sourcing
Output voltage	24 VDC	24 VDC	24 VDC	24 VDC
Field power for outputs current consumption	109 mA (Plus load current)	109 mA (Plus load current)	109 mA (Plus load current)	109 mA (Plus load current)
Bus power current consumption	30 mA	30 mA	30 mA	30 mA
Output current per channel	0.5 A	0.5 A	2.0A	0.1 A
Output delay	3 ms	3 ms	3 ms	3 ms
Load type	Resistive, Inductive, Lamp Load	Resistive, Inductive, Lamp Load	Resistive, Inductive, Lamp Load	Resistive, Inductive
Load resistance, resistive	>48 Ohm	>48 Ohm	>12 Ohm	>250 Ohm
Load resistance, inductive	<1.2 H	<1.2 H	<1.2 H	<1.2 H
Lamp load	< 3W	< 3W	< 10W	< 10W
Switching frequency, resistive	<200 Hz	<200 Hz	<200 Hz	<200 Hz
Switching frequency, inductive	< 2 Hz	< 2 Hz	< 2 Hz	< 2 Hz
Switching frequency, lamp load	< 20 Hz	< 20 Hz	< 20 Hz	< 20 Hz
Short-circuit protection	Group Protection	Group Protection	Group Protection	Group Protection
Diagnostic bits	4	8	4	16

PNP (Sourcing)

PNP input modules provide sourcing capabilities. When the input field device is passing, current flows from the input device into the Turck input module.

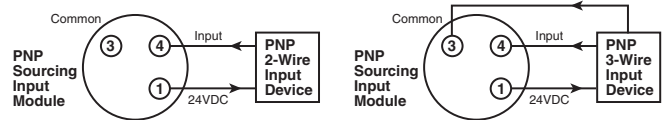

Digital NPN Output Modules

Digital DC Output Module	BL67-8DO-0.5A-N	BL67-4DO-2A-N
Number of outputs	8	4
Sensor requirement	NPN Sinking	NPN Sinking
Output voltage	24 VDC	24 VDC
Field power for outputs current consumption	109 mA (Plus load current)	109 mA (Plus load current)
Bus power current consumption	30 mA	30 mA
Output current per channel	0.5 A	2.0 A
Output delay	3 ms	3 ms
Load type	Resistive, Inductive, Lamp Load	Resistive, Inductive, Lamp Load
Load resistance, resistive	>48 Ohm	>48 Ohm
Load resistance, inductive	<1.2 H	<1.2 H
Lamp load	< 3W	< 3W
Switching frequency, resistive	<200 Hz	<200 Hz
Switching frequency, inductive	< 2 Hz	< 2 Hz
Switching frequency, lamp load	< 20 Hz	< 20 Hz
Short-circuit protection	Group Protection	Group Protection
Diagnostic bits	4	8

NPN (Sinking)

NPN input modules provide sinking capabilities. When the input field device is passing, current out of the Turck input module into the field input device.

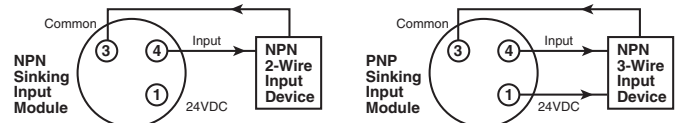

D
 Subbase & Manual
 Valves
 H Series
 Micro
 Modflex
 Series
 H Series
 ISO
 Network
 Connectivity
 DX ISOMAX
 Series
 Valvair II
 Series



For inventory, lead times, and kit lookup, visit www.pdnplu.com

D218

Parker Hannifin Corporation
 Pneumatic Division
 Richland, Michigan
www.parker.com/pneumatics

Relay Output Modules

Relay Output Module	BL67-8DO-R-NO
Number of outputs	8
Output type	Relay
Output voltage	24 VDC
Field power for outputs current consumption	109 mA (Plus load current)
Bus power current consumption	30 mA
Output current per channel	100 mA
Output delay	3 ms
Load type	Resistive, TTL logic
Switching resistor	<31 Ohm
Switching frequency, resistive	<200 Hz
Short-circuit protection	None

Combination Digital Modules

Combination Input and Output Modules	BL67-4DI4DO-PD	BL-67-8XSG-PD
Number of outputs	4	Configurable 0 to 8
Number of inputs	4	Configurable 0 to 8
Total channels	8	8
Sensor requirement	PNP Sourcing	PNP Sourcing
Voltage, on-state input, nom.	24 VDC	24 VDC
Output voltage	24 VDC	24 VDC
Field power for outputs current consumption	109 mA	109 mA
Bus power current consumption	30 mA	30 mA
Input low level signal voltage	<4.5 V	<4.5 V
Input high level signal voltage	7...30V	7...30V
Input low level signal current	<1.5 mA	<1.5 mA
Input high level signal current	2.1...3.7 mA	2.1...3.7 mA
Input delay	0.25; 2.5 ms	0.25; 2.5 ms
Output current per channel	0.5 A	0.5 A
Output delay	3 ms	3 ms
Load type	Resistive, Inductive, Lamp Load	Resistive, Inductive, Lamp Load
Load resistance, resistive	>48 Ohm	>48 Ohm
Load resistance, inductive	<1.2 H	<1.2 H
Lamp load	< 3W	< 3W
Switching frequency, resistive	<200 Hz	<200 Hz
Switching frequency, inductive	< 2 Hz	< 2 Hz
Switching frequency, lamp load	< 20 Hz	< 20 Hz
Short-circuit protection	Channel Protection	Channel Protection
Diagnostic bits	8	12

D

Subbase & Manual Valves

H Series Micro

Modulflex Series

H Series ISO

Network Connectivity

DX ISOMAX Series

Valvair II Series



For inventory, lead times, and kit lookup, visit www.pdnplu.com

D219

Parker Hannifin Corporation
 Pneumatic Division
 Richland, Michigan
www.parker.com/pneumatics

Analog Input Modules

Analog Input Module	BL67-2AI-I	BL67-2AI-V	BL67-4AI-V/I
Number of inputs	2	2	4
Nominal voltage	24 VDC	24 VDC	24 VDC
Field power for inputs current consumption	22 mA	22 mA	22 mA
Bus power current consumption	35 mA	35 mA	35 mA
Analog input type	0/4...20mA	-10/0...+10 VDC	0/4...20mA or -10/0...+10 VDC
Input resistance	<0.125 kOhm	<98.5 kOhm	<0.125 kOhm or <98.5 kOhm
Maximum limiting frequency	50 Hz		20 Hz
Fault limit @ 23 degree C	<0.2%		<0.3%
Repeatability	0.05%	0.05%	0.05%
Temperature coefficient (ppm/degree C of full scale)	<300	<150	<300
Resolution	16 Bit	16 Bit	16 Bit
Measuring principle	Sigma Delta	Sigma Delta	Sigma Delta
Measured value display	16 bit signed integer, 12 bit full range left justified	16 bit signed integer, 12 bit full range left justified	16 Bit signed integer, 12 bit full range left justified
Diagnostic bits	16		32

Temperature Inputs

Analog Input Module	BL67-2AI-PT	BL67-2AI-TC
Number of inputs	2	2
Nominal voltage	24 VDC	24 VDC
Field power for inputs current consumption	58 mA	40 mA
Bus power current consumption	45 mA	35 mA
Temperature input type	PT100, PT200, PT500, PT1000, Ni100, Ni1000	B, E, J, K, N, R, S, T
Voltage resolution	n/a	+/- 50mV; <2uV
Fault limit @ 23 degree C	<0.2%	<0.2%
Repeatability	0.05%	0.05%
Temperature coefficient (ppm/degree c of full scale)	<300	<300
Resolution	16 Bit	16 Bit
Measured value display	16 bit signed integer, 12 bit full range left justified	16 bit signed integer, 12 bit full range left justified
Diagnostic bits	16	16

D

Subbase & Manual
Valves

H Series
Micro

Modulflex
Series

H Series
ISO

Network
Connectivity

DX ISOMAX
Series

Valvair II
Series



For inventory, lead times, and kit lookup, visit www.pdnplu.com

D220

Parker Hannifin Corporation
Pneumatic Division
Richland, Michigan
www.parker.com/pneumatics

Analog Input Modules

Analog Input Module	BL67-2AO-I	BL67-2AO-V
Number of inputs	2	2
Nominal voltage	24 VDC	24 VDC
Field power for outputs current consumption	62 mA	67 mA
Bus power current consumption	40 mA	60 mA
Analog output type	0/4...20mA	-10/0...+10 VDC
Output current per channel	n/a	250 mA
Load resistance, resistive	<0.45 kOhm	> 1kOhm
Load resistance, inductive	< 1 mH	n/a
Load resistance, capacitive	n/a	> 1 uF
Transmission frequency	<200 Hz	< 100 Hz
Fault limit @ 23 degree C	<0.2%	<0.2%
Repeatability	0.05%	0.05%
Temperature coefficient (ppm/degree c of full scale)	< 150	<300
Resolution	16 bit	16 bit
Measured value display	16 bit signed integer, 12 bit full range left justified	16 bit signed integer, 12 bit full range left justified

Combination Analog Modules

Analog Combination Module	BL67-4AI4AO-V/I	BL67-2AI2AO-V/I
Number of analog inputs	4	2
Number of analog outputs	4	2
Nominal voltage	24 VDC	24 VDC
Field power for outputs current consumption	67 mA	67 mA
Bus power current consumption	60 mA	60 mA
Analog input type	0/4...20mA or -10/0...+10 VDC	0/4...20mA or -10/0...+10 VDC
Input resistance	0.065 or 225 kOhm	0.065 or 225 kOhm
Maximum limiting frequency	20 Hz	20 Hz
Fault limit @ 23 degree c	<0.3%	<0.3%
Repeatability	0.05%	0.05%
Temperature coefficient (ppm/degree c of full scale)	<300	<300
Resolution	16 bit	16 bit
Measuring principle	Sigma Delta	Sigma Delta
Measured value display	16 bit signed integer, 12 bit full range left justified	16 bit signed integer, 12 bit full range left justified
Analog output type	-10/0...+10 VDC	-10/0...+10 VDC
Output current per channel	250 mA	250 mA
Load resistance, resistive	>1 kOhm	> 1 kOhm
Load resistance, capacitive	<1 uF	< 1 uF
Transmission frequency	< 100 Hz	< 100 Hz
Fault limit @ 23 degree C	<0.3%	<0.3%
Repeatability	0.05%	0.05%
Temperature coefficient (ppm/degree c of full scale)	<300	<300
Resolution	16 bit	16 bit
Measured value display	16 bit signed integer, 12 bit full range left justified	16 bit signed integer, 12 bit full range left justified
Diagnostic bits	8	4

D

Subbase & Manual Valves

H Series Micro

Modulflex Series

H Series ISO

Network Connectivity

DX ISOMAX Series

Valvair II Series



For inventory, lead times, and kit lookup, visit www.pdnplu.com

D221

Parker Hannifin Corporation
 Pneumatic Division
 Richland, Michigan
www.parker.com/pneumatics

Power Extender Module

Power Extender Module	BL67-PF-24VDC
Nominal voltage	24 VDC
Field power for outputs current consumption	9 mA
Bus power current consumption	30 mA
Supply for field power for inputs current	4.0 A
Supply for field power for outputs current	10 A
Diagnostic bits	3

RS232 Interface

RS232 Interface	BL67-1RS232
Number of channels	1
Field power for inputs current consumption	90 mA
Bus power current consumption	140 mA
Transmission level active (u rs1)	-15 to -3 VDC
Transmission level inactive (urso)	3 to 15 VDC
Common-mode range (ugl)	-7 to 12 VDC
Transmission signals	RxD, TxD, RTS, CTS
Data buffer received	128 Byte
Send data buffer	64 Byte
Connection type	Full Duplex
Transmission rate	300 to 115200 bps
Parameter	Transmission Rate, Diagnostics, Data Bits, Stop Bits, XON - Character, XOFF - Character, Parity, Flow Control
Cable length	15 m
Diagnostic bits	8

RS485 / 422 Interface

RS485/422 Interface	BL67-1RS485/422
Number of channels	1
Field power for inputs current consumption	42 mA
Bus power current consumption	60 mA
Transmission signals	RxD, TxD
Connection type	2 Wire Half Duplex or 4 Wire Full Duplex
Transmission rate	300 to 115200 bps
Parameter	RS485/422, Transmission Rate, Diagnostics, Data Bits, Stop Bits, XON - Character, XOFF - Character, Parity, Flow Control
Cable length	1000 m
Line impedance	120 Ohm
Bus termination	External
Diagnostic bits	8

D
 Subbase & Manual
 Valves
 H Series
 Micro
 Modulfex
 Series
 H Series
 ISO
 Network
 Connectivity
 DX ISOMAX
 Series
 Valvair II
 Series



For inventory, lead times, and kit lookup, visit www.pdnplu.com

D222

Parker Hannifin Corporation
 Pneumatic Division
 Richland, Michigan
www.parker.com/pneumatics

SSI Sensor Interface

SSI Sensor Interface	BL67-1SSI
Number of channels	1
Field power for inputs current consumption	39 mA
Bus power current consumption	50 mA
Transmission signals	CL, D
Connection type	4 Wire Full Duplex (Clock Output/Signal Input)
Transmission rate	62.5 kbps up to 1 Mbps
Parameter	Transmission Rate, Diagnostics, Data Format (Binary / GRAY coded), Data Fram Bits (1-32), Number of Invalid Bits (LSB: 0-15, MSB 0-7)
Cable length	30 m
Diagnostic bits	8

Counting Module

Counting Module	BL67-1CNT/ENC
Number of channels	1
Field power for inputs current consumption	109 mA
Bus power current consumption	30 mA
Input type	PNP
Output type	PNP
Output current per channel	0.5 A
Output delay	2 ms
Load type	Resistive
Frequency measurement	Up to 250 kHz
Speed measurement	Factor Configurable
Period duration measurement	2 usec
Upper count limit	0x80000000 up to 0xFFFFFFFF
Lower count limit	0x80000000 up to 0xFFFFFFFF
Short circuit protection	Channel Protection

CANopen Expansion Module

CANopen Expansion Module	BL67-1CVI
Number of channels	1
Field power for inputs current consumption	109 mA
Bus power current consumption	30 mA
Transmission signals	CAN High, CAN Low
Connection type	CANopen
Transmission speed	10 kbps up to 1 Mbps
Parameter	Transmission Rate, Diagnostics, Bus Termination, Range of I/O Data
Bus termination	Internal
Diagnostic bits	48
Max number of CANopen nodes	8
Max processing data per module	8 Byte
Max data per node	4 Byte

D

Subbase & Manual Valves

H Series Micro

Moduflex Series

H Series ISO

Network Connectivity

DX ISOMAX Series

Valvair II Series



For inventory, lead times, and kit lookup, visit www.pdnplu.com

D223

Parker Hannifin Corporation
 Pneumatic Division
 Richland, Michigan
www.parker.com/pneumatics

Power Distribution Options for Turk Network Portal

Turk Communication and I/O Modules - DeviceNet and CANopen, Power Over Network

The 24VDC power supply pins from the DeviceNet or CANopen network connection on the communication module provides a single power circuit. This circuit provides 1.5A bus power, 4A field power for inputs and 8A field power for outputs.

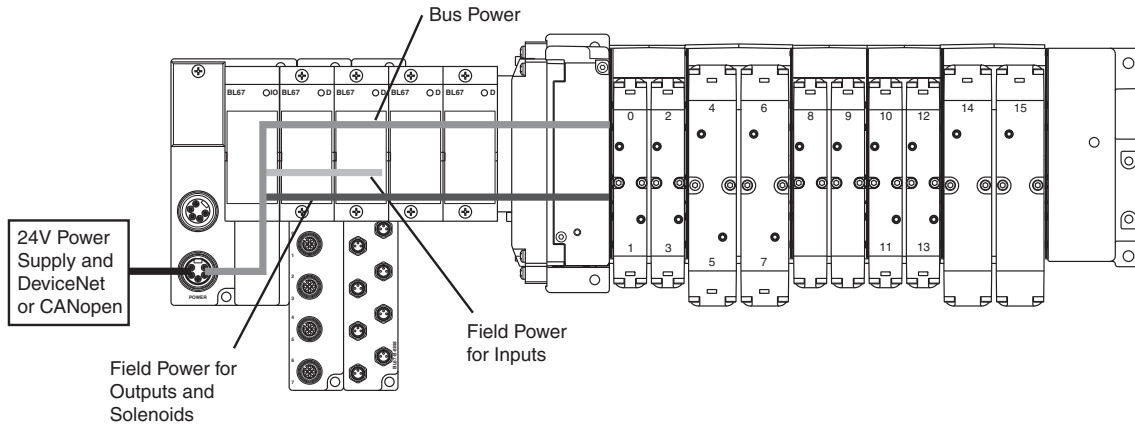

Turk Communication and I/O Modules - EtherNet/IP™, Modbus/TCP, Profinet, Profibus, and CANopen

An auxiliary 24VDC power supply from the communication module provides power across two separate circuits. The first circuit provides 1.5A bus power and 4A field power for inputs. The second circuit provides 10A field power for outputs which can be wired to an e-stop circuit to kill all outputs.

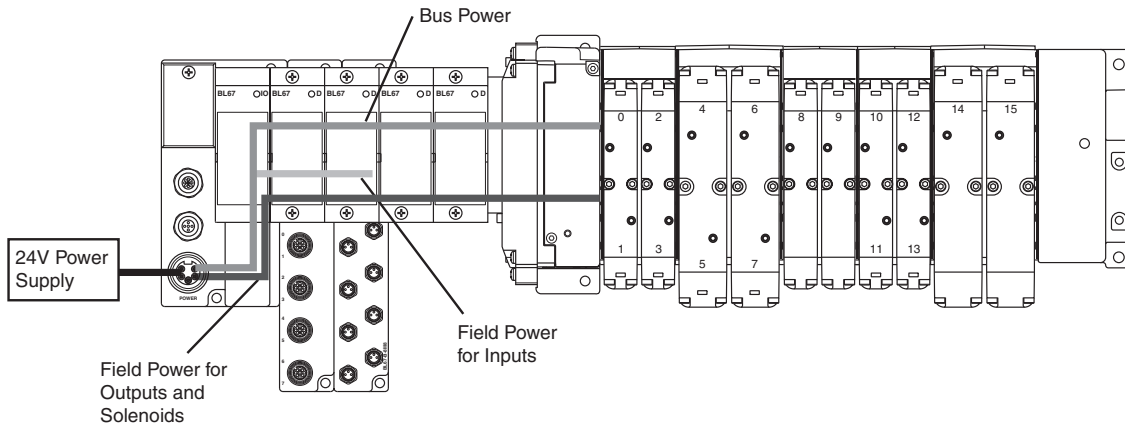

D
Subbase & Manual
Valves
H Series Micro
Modulflex Series
H Series ISO
Network Connectivity
DX ISOMAX Series
Valvair II Series



For inventory, lead times, and kit lookup, visit www.pdnplu.com

Power Distribution Options for Turk Network Portal (continued)

24VDC Power Extender Module (BL67-PF-24VDC) with Base Module BL67-B-1RSM

This configuration creates an auxiliary 24VDC power supply and provides power across two separate circuits, regardless of the communication module used. The first circuit provides 4A field power for inputs. The second circuit provides 10A field power for outputs which can be wired to an e-stop circuit to kill all outputs and solenoids to the right of the module. The 1.5A bus power is uninterrupted, and is still supplied from the communication module.

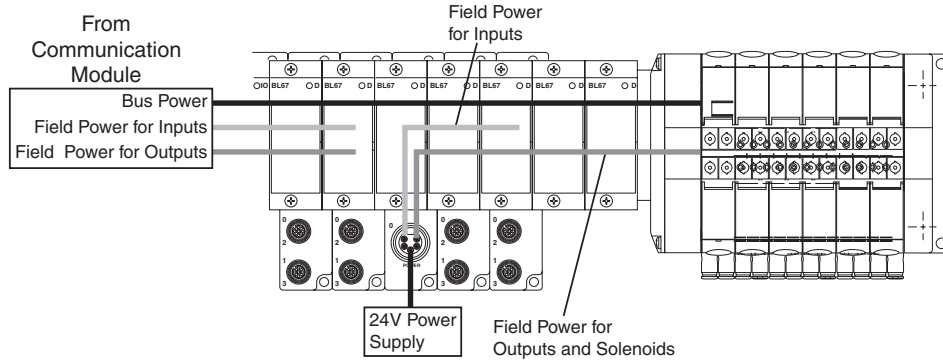

24VDC Power Extender Module (BL67-PF-24VDC) with Base Module BL67-B-1RSM-4

This configuration creates an auxiliary 24VDC power supply and provides power across one circuit, regardless of the communication module used. This circuit provides 4A field power for inputs and 10A field power for outputs. The 1.5A bus power is uninterrupted, and is still supplied from the communication module.

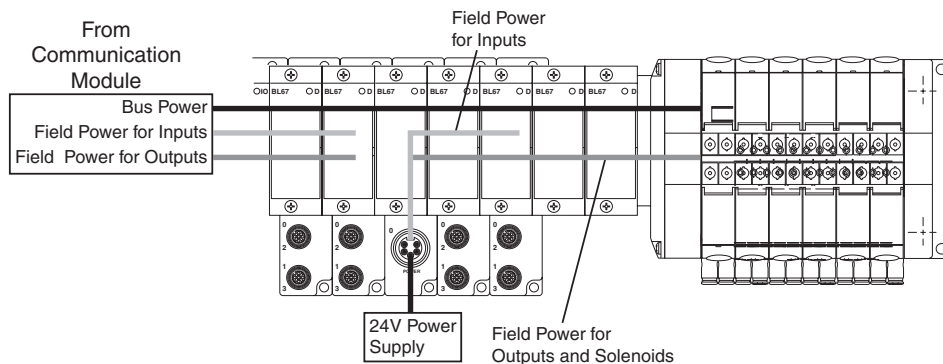

24VDC Power Extender Module (BL67-PF-24VDC) with Base Module BL67-B-1RSM-VO

This configuration creates an auxiliary 24VDC power supply and provides power across one circuit, regardless of the communication module used. This circuit provides 10A field power for outputs which can be wired to an e-stop circuit to kill all outputs and solenoids to the right of the module. The 1.5A bus power and 4A field power for inputs are uninterrupted, and are still supplied from the communication module.

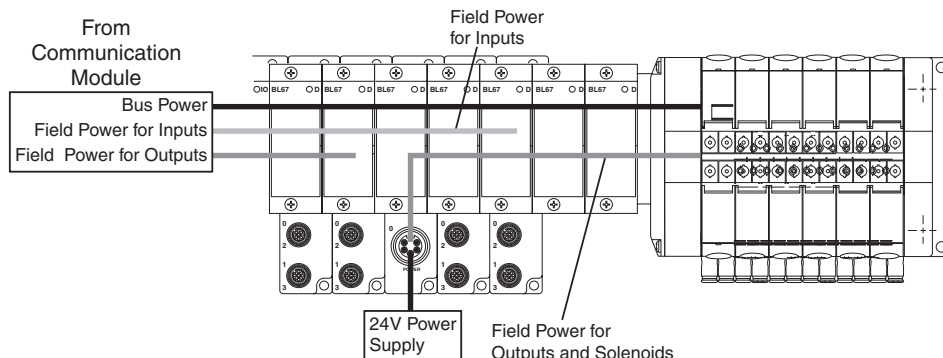

For inventory, lead times, and kit lookup, visit www.pdnplu.com

D225

Parker Hannifin Corporation
 Pneumatic Division
 Richland, Michigan
www.parker.com/pneumatics

D

Subbase & Manual Valves

H Series Micro

Moduflex Series

H Series ISO

Network Connectivity

DX ISOMAX Series

Valvair II Series

7/8" Mini Power Cables - P2H Network Node, H Series Network Portal, Turck Network Portal

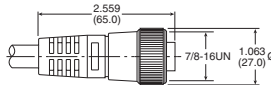
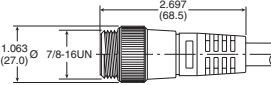
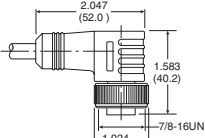
	Description	Part Number
 RKM Female Socket	4-pin female to flying lead cable, 5 meters, TPE	RKM 46-5M/S1587
	5-pin female to flying lead cable, 5 meters, TPE	RKM 56-5M/S1587
 RSM Male Pins	4-pin male to female cable, TPE	RSM RKM 46-x/S1587
	5-pin male to female cable, TPE	RSM RKM 56-x/S1587
 WKM Female Socket	4-pin right angle female to flying lead cable, 5 meters, TPE	WKM 46-5M/S1587
	5-pin right angle female to flying lead cable, TPE	WKM 56-5M/S1587

Where x = 2, 4, 5, 6, 8, 10 meter standard lengths

Power Tee - P2H Network Node, H Series Network Portal, Turck Network Portal

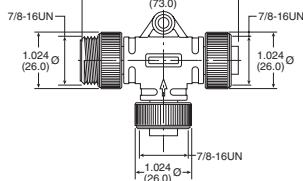
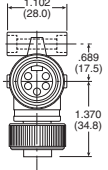
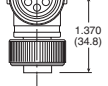
	Description	Part Number
   RSM-2RKM 40 RSM-2RKM 50	4-pin Male to 2 female sockets	RSM-2RKM 40
	5-pin Male to 2 female sockets	RSM-2RKM 50

M12 A-code Cables - P2M IO-Link, P2H IO-Link, H Series IO-Link Network Portal, Turck IO-Link Network Portal

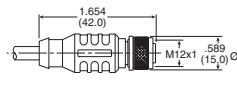
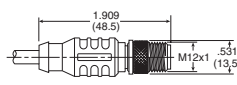
	Description	Part Number
 RKC Female Sockets	4-pin female to flying lead cable, PVC	RKC 4.4T-1
	4-pin male to flying lead cable, PVC	RSC 4.4T-*
 RSC Male Pins	4-pin male to female cable, PVC	RKC 4.4T-*/RSC 4.4T
	5-pin female to flying lead cable, TPE	RKC 4.5T-*/S1587
	5-pin male to flying lead cable, TPE	RSC 4.5T-4/S1587
	5-pin male to female cable, TPE	RKC 4.5T-*/RSC 4.5T/S1587

Where * = 1, 2, 3, 4 meter standard lengths

M8 Cables - H Series IO-Link Network Portal, Turck IO-Link Network Portal

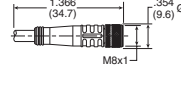
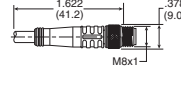
	Description	Part Number
  M8x1	3-pin female to flying lead cable, PUR	PKG 3M-4/S90
	3-pin male to flying lead cable, PUR	PSG 3M-*/S90
	3-pin male to female cable, PUR	PKG 3M-*/PSG 3M/S90

Where * = 1, 2, 3, 4 meter standard lengths

Most popular.



For inventory, lead times, and kit lookup, visit www.pdnplu.com

D226

Parker Hannifin Corporation
 Pneumatic Division
 Richland, Michigan
www.parker.com/pneumatics

D
 Subbase & Manual Valves
 H Series Micro Series Modulflex Series
 H Series ISO Network Connectivity
 DX ISOMAX Series
 Valvaire II Series

M23 Cables

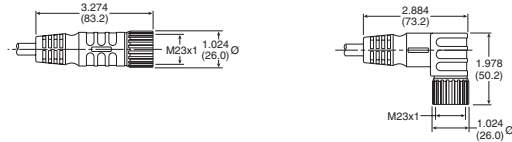

Description	Part Number
12-pin, double ended female thread with male pins and female socket, PUR. Pinout optimized for H Series Network Portal.	CSCM CKCM 12-11-x/S90
19-pin, double ended female thread with male pins and female socket, PUR. Pinout optimized for H Series Network Portal.	CSM CKM 19-19-x/S90
19-pin, 90° double ended female thread with male pins and female socket, PUR. Pinout optimized for Turck Network Portal.	CSWM CKWM 19-19-x/CS12852

Where x = 1, 2, 3, 4 meter standard lengths

PROFIBUS Cables - P2M Network Node, Turck Network Portal

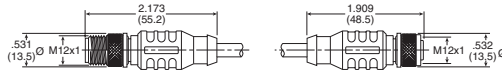

Description	Part Number
M12 male to M12 female, PUR	RSSW RKSX 455-xM

Where x = 2, 4, 5, 6, 8, 10 meter standard lengths

RSSW Side, Male Pins

RKSX Side, Female Sockets

PROFIBUS Terminating Resistor - P2M Network Node, Turck Network Portal



Male Pins

Description	Part Number
M12 male pin terminating resistor	P8BPA00MB

Ethernet Cables - P2M Network Node, H Series Network Portal, Turck Network Portal

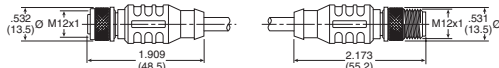

RKSD Side, Female Sockets

RSSD Side, Male Pins

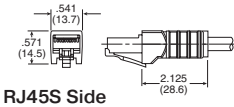

RJ45S Side

Description	Part Number
M12 female to M12 male, PUR	RSSD RKSD 443-xM
RJ45 to M12 male, PUR	RSSD RJ45S 443-2M

Where x = 2, 5, 10, 15, 20, 30 meter standard lengths

25-pin, D-Sub Cable (Female)

Description	Length	Part Number
25-pin, D-sub cable, IP20, PUR	3 meters	P8LMH25M3A
25-pin, D-sub cable, IP20, PUR	9 meters	SCD259D
25-pin, D-sub cable, IP65, PUR	3 meters	SCD253W
25-pin, D-sub cable, IP65, PUR	9 meters	SCD259WE

Most popular.



For inventory, lead times, and kit lookup, visit www.pdnplu.com

D227

Parker Hannifin Corporation
 Pneumatic Division
 Richland, Michigan
www.parker.com/pneumatics

D

Subbase & Manual Valves

H Series Micro

Moduflex Series

H Series ISO

Network Connectivity

DX ISOMAX Series

Valvair II Series

DeviceNet and CANopen Cables - P2M Network Node, H Series Network Portal, Turck Network Portal

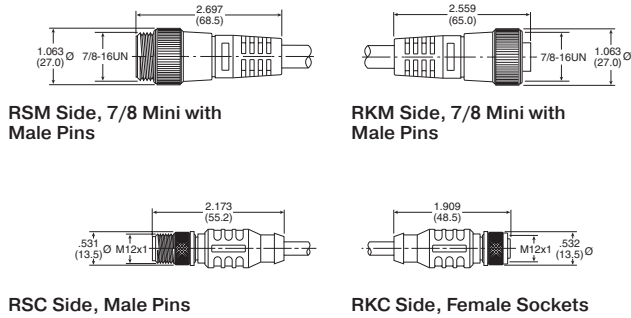

Description	Part Number
7/8" mini male to 7/8" mini female, PUR	RSM RKM 5711-xM
7/8" mini male to M12 female, PUR	RSM RKC 5711-xM
M12 male to M12 female, PUR	RSC RKC 5711-xM
M12 male to 7/8" mini female, PUR	RSC RKM 5711-xM

Where x = 2, 4, 5, 6, 8, 10 meter standard lengths

Bus Power Tee - P2M Network Node, H Series Network Portal, Turck Network Portal

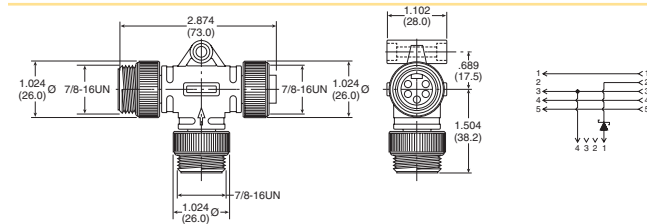

Description	Part Number
Bus power tee	RSM RKM 57 WSM 40 PST
For systems not equipped with Power over network, combines separate network and power feeds into the communication module. Includes reverse current protection	

DeviceNet & CANopen Terminating Resistor - P2M Network Node, H Series Network Portal, Turck Network Portal

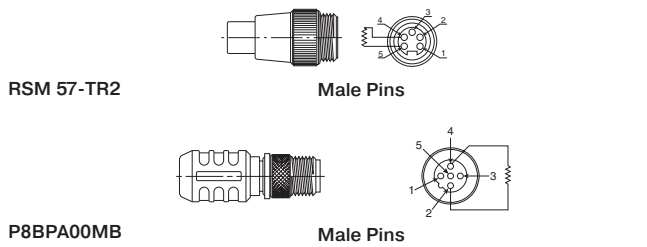

Description	Part Number
7/8" Mini Male Pin Terminating Resistor	RSM 57-TR2
M12 Male Pin Terminating Resistor	P8BPA00MA

M12 Power Splitter - PCH Network Portal, Turck Network Portal, P2M IO-Link, P2H IO-Link

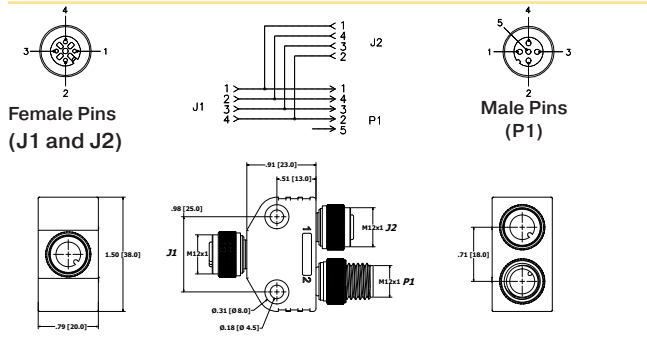

Description	Part Number
M12 Parallel Splitter	100010909

Most popular.



For inventory, lead times, and kit lookup, visit www.pdnplu.com

D228

Parker Hannifin Corporation
Pneumatic Division
Richland, Michigan
www.parker.com/pneumatics

D
 Subbase & Manual Valves
 H Series Micro
 Modulflex Series
 H Series ISO
 Network Connectivity
 DX ISOMAX Series
 Valvair II Series

Turck with H Series ISO Valves

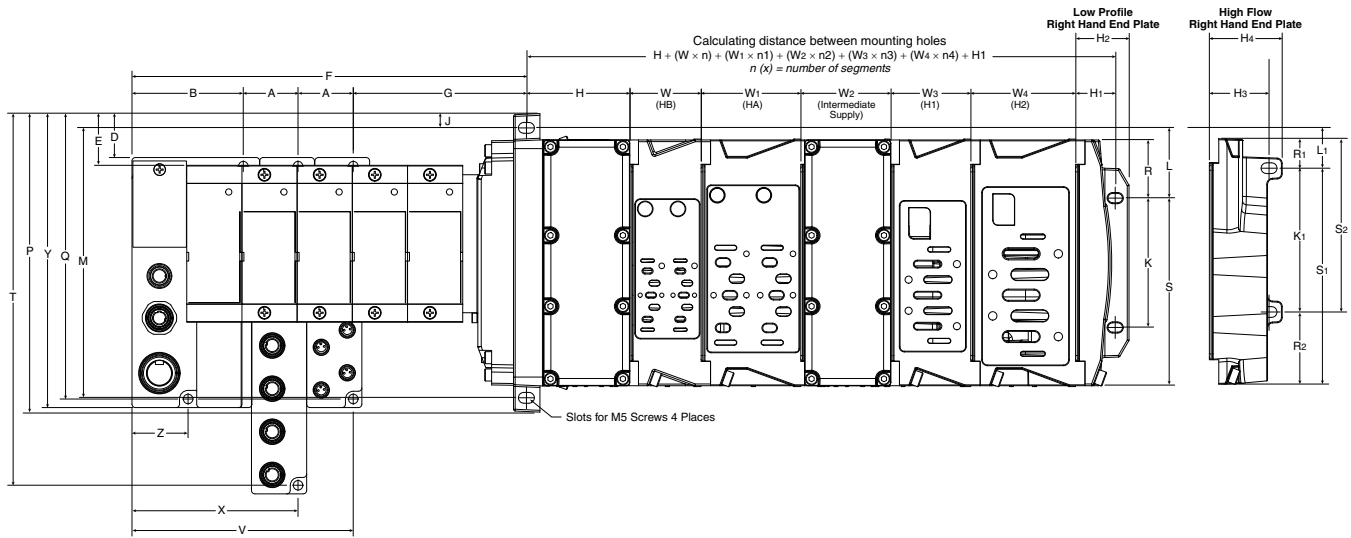

$n(x) = \text{number of segments}$

A	B	D	E	F	G	H	H1	H2	H3	H4	J
1.26 (32.0)	2.54 (64.5)	1.00 (25.4)	1.18 (29.9)	8.99 (228.4)	3.94 (100.1)	2.36 (60.0)	0.90 (23.0)	1.22 (31.0)	1.36 (34.6)	1.66 (42.3)	0.33 (8.3)
K	K1	L	L1	M	P	Q	R	R1	R2	S	S1
2.95 (75.0)	3.28 (83.4)	1.60 (40.7)	0.96 (24.3)	6.16 (156.5)	6.81 (173.1)	6.51 (165.4)	1.33 (33.7)	0.68 (17.3)	1.65 (41.8)	4.28 (108.8)	4.93 (125.2)
S2	T	V	W	W1	W2	W3	W4	X	Y	Z	
3.96 (100.7)	8.48 (215.4)	5.05 (128.3)	1.63 (41.3)	2.28 (57.8)	2.06 (52.3)	1.82 (46.3)	2.39 (60.8)	3.79 (96.3)	6.71 (170.4)	1.28 (32.5)	

Inches (mm)

H3 Manifold Assembly

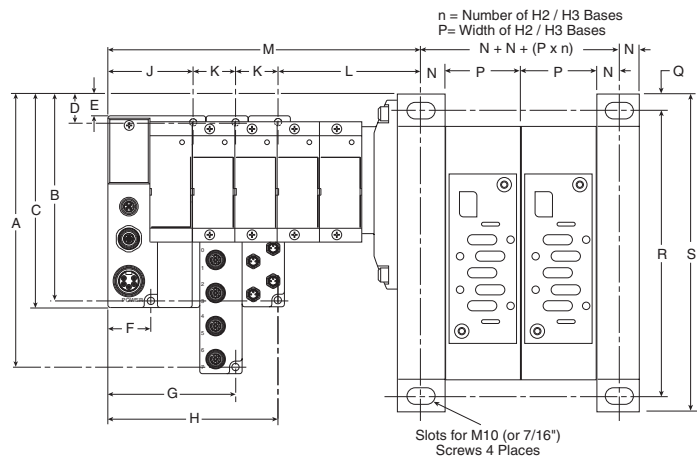

A	B	C	D	E	F	G	H	J	K	L	M	N	P	Q	R	S
8.62 (218.9)	6.65 (168.9)	6.85 (173.9)	1.33 (33.9)	1.14 (28.9)	1.28 (32.5)	3.79 (96.5)	5.06 (128.5)	2.53 (64.5)	1.26 (32)	4.34 (110)	See note 1	.65 (16.5)	2.80 (71)	.59 (15)	10.43 (265)	11.61 (295)

Note 1: $M = J + L + n_2 \times K$, where $n_2 = \text{Number of Turck input / output modules}$

Inches (mm)



For inventory, lead times, and kit lookup, visit www.pdnplu.com

D229

Parker Hannifin Corporation
 Pneumatic Division
 Richland, Michigan
www.parker.com/pneumatics

D

Subbase & Manual Valves

H Series Micro

Modulflex Series

H Series ISO

Network Connectivity

DX ISOMAX Series

Valvair II Series

Turck with H Series ISO Valves

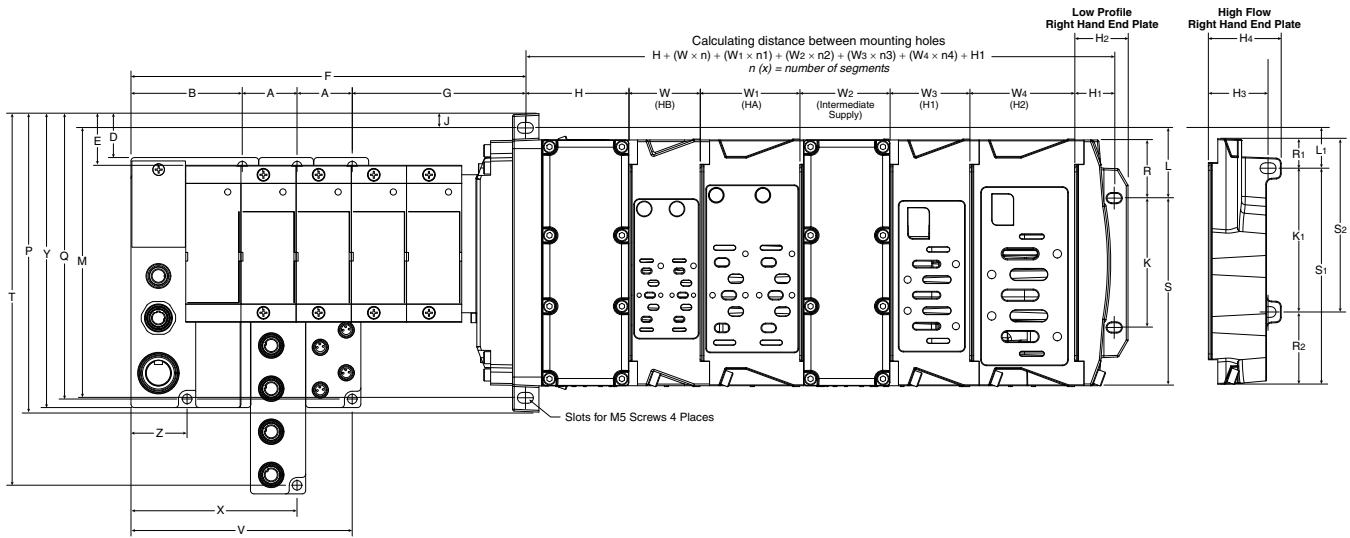

n (x) = number of segments

A	B	D	E	F	G	H	H1	H2	H3	H4	J
1.26 (32.0)	2.54 (64.5)	1.00 (25.4)	1.18 (29.9)	8.99 (228.4)	3.94 (100.1)	2.36 (60.0)	0.90 (23.0)	1.22 (31.0)	1.36 (34.6)	1.66 (42.3)	0.33 (8.3)
K	K1	L	L1	M	P	Q	R	R1	R2	S	S1
2.95 (75.0)	3.28 (83.4)	1.60 (40.7)	0.96 (24.3)	6.16 (156.5)	6.81 (173.1)	6.51 (165.4)	1.33 (33.7)	0.68 (17.3)	1.65 (41.8)	4.28 (108.8)	4.93 (125.2)
S2	T	V	W	W1	W2	W3	W4	X	Y	Z	
3.96 (100.7)	8.48 (215.4)	5.05 (128.3)	1.63 (41.3)	2.28 (57.8)	2.06 (52.3)	1.82 (46.3)	2.39 (60.8)	3.79 (96.3)	6.71 (170.4)	1.28 (32.5)	

Inches (mm)

H3 Manifold Assembly

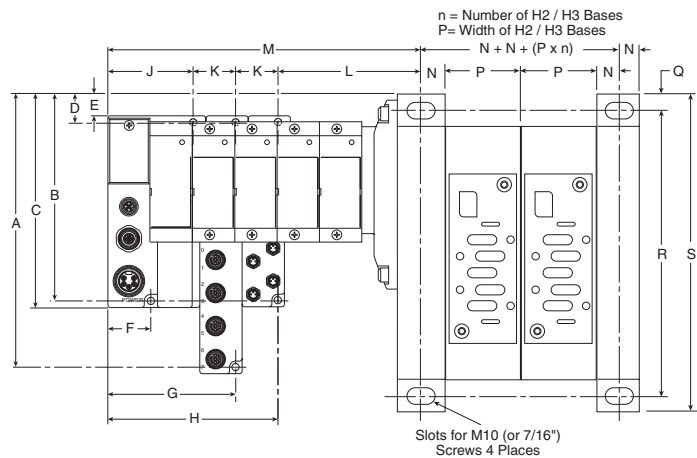

A	B	C	D	E	F	G	H	J	K	L	M	N	P	Q	R	S
8.62 (218.9)	6.65 (168.9)	6.85 (173.9)	1.33 (33.9)	1.14 (28.9)	1.28 (32.5)	3.79 (96.5)	5.06 (128.5)	2.53 (64.5)	1.26 (32)	4.34 (110)	See note 1	.65 (16.5)	2.80 (71)	.59 (15)	10.43 (265)	11.61 (295)

Note 1: M = J + L + n₂ x K, where n₂ = Number of Turck input / output modules
 Inches (mm)



For inventory, lead times, and kit lookup, visit www.pdnplu.com

D231

Parker Hannifin Corporation
 Pneumatic Division
 Richland, Michigan
www.parker.com/pneumatics

D

**Subbase & Manual
 Valves**

**H Series
 Micro**

**Moduflex
 Series**

**H Series
 ISO**

**Network
 Connectivity**

**DX ISOMAX
 Series**

**Valvair II
 Series**

DX ISOMAX Series

The ISOMAX range of directional control valves complies with ISO 15407-1 and VDMA 24563 for sizes 02 and 01 and ISO 5599-1 for sizes 1, 2 and 3. ISOMAX provides flows from 0.55 Cv to 4.15 Cv.

The ISOMAX range includes valves for pneumatic and electrical actuation with a wide choice of subbases and manifolds to suit different application needs.

All ISOMAX products use high-tech ceramic switching technology providing:

Excellent reliability

- Long life in excess of 100 million operations*
- Operates with lubricated or non-lubricated air
- Low sensitivity to air quality changes

High performance

- Slide valve concept allows high flow / size ratio and short response time due to short slide stroke and low friction

Stable long lasting performances

- Low friction switching: minimum wear of the valve member / seal assembly

Valves fitted with switchable selector to give internal or external pilot supply

Corrosion free and modern design

Vacuum operation

Dual pressure

* Refer to our warranty conditions.

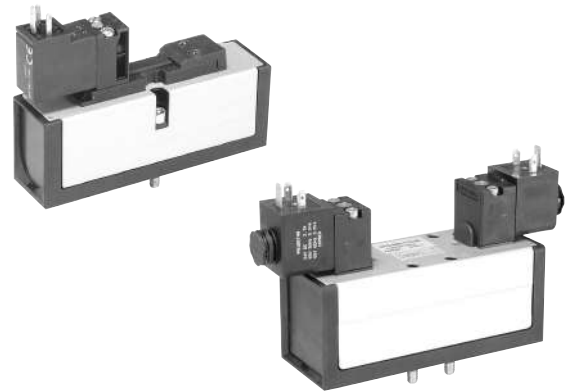

Operating information

Operating Pressure: Vacuum to 145 PSIG (10 bar)

Function		M.O.P (PSIG)
20, 21, 22, 23	2-position, spring return	36
50, 51, 53, 54	2-position, air return	30
04, 05, 06, 08	2-position	15
09, 11, 12, 27	3-position, CE	45
16, 18, 19, 25	3-position, APB	45

Working temperatures:

-10°C to 60°C (14°F to 140°F)

Storage temperatures:

-20°C to 70°C (-4°F to 158°F)

Material specifications

Body	Polyamide reinforced fiberglass
Casing	Anodized aluminum
End plates	Painted zinc plated steel
Function selector	Polyamide reinforced fiberglass
Screws	Zinc plated steel
Seals	Nitrile
Seat	Ceramic
Springs	Stainless steel
Top cover seals	Polyester
Valve members	Self lubricating acetal
Valve plate	Zinc

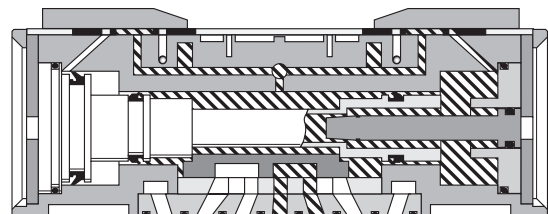
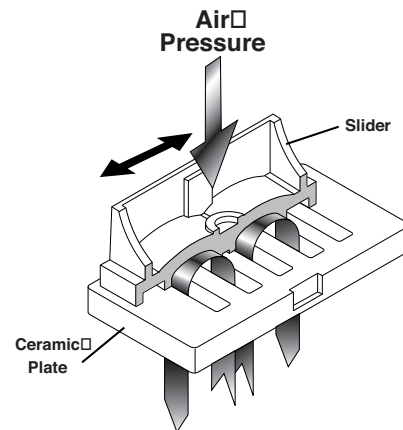
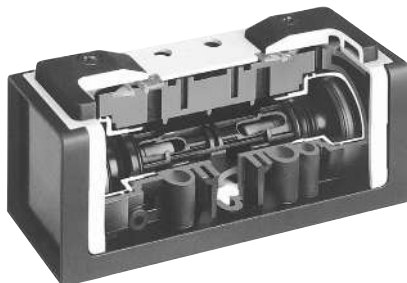

Remote Pilot

D

Subbase & Manifold Valves

H Series Micro

Modulflex Series

H Series ISO

Network Connectivity

DX ISOMAX Series

Valvair II Series







For inventory, lead times, and kit lookup, visit www.pdnplu.com

D232

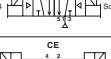
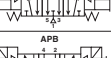

Parker Hannifin Corporation
Pneumatic Division
Richland, Michigan
www.parker.com/pneumatics

Common Part Numbers

DX02 ISO Solenoid Valves

Symbol	Type	Cv	Operator	Pilot	Override	24 VDC	120 VAC
	4-way, 2-position, spring return	0.55	Single solenoid	Internal	Non-locking	DX02-621-951M	DX02-621-951J
	4-way, 2-position, air return	0.55	Single solenoid	Internal	Non-locking	DX02-651-951M	DX02-651-951J
	4-way, 2-position	0.55	Double solenoid	Internal	Non-locking	DX02-606-951M	DX02-606-951J
	4-way, 3-position, center exhaust	0.4	Double solenoid	Internal	Non-locking	DX02-611-951M	DX02-611-951J
	4-way, 3-position, all ports blocked	0.4	Double solenoid	Internal	Non-locking	DX02-616-951M	DX02-616-951J

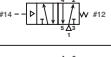

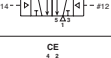
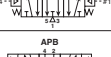
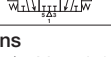
DX02 ISO Remote Pilot Valves

Symbol	Type	Cv	Operator	Pilot	Part Number
	4-way, 2-position, spring return	0.55	Single remote pilot	Remote	DX02-421-60
	4-way, 2-position, air return	0.55	Single remote pilot	Remote	DX02-451-60
	4-way, 2-position	0.55	Double remote pilot	Remote	DX02-406-60
	4-way, 3-position, center exhaust	0.4	Double remote pilot	Remote	DX02-411-60
	4-way, 3-position, all ports blocked	0.4	Double remote pilot	Remote	DX02-416-60





Torque Specifications

DX02: 15 to 25 in-lbs (1.69 to 2.82 Nm) DX01: 20 to 30 in-lbs (2.26 to 3.39 Nm)

Base / End Plate - 15407-1, Non Plug-in, Size DX02

	Description	NPT	BSPP
	Universal manifold base 2 station, end ported	PSHU115101P	PSHU115201P
	Universal end plate Non-collective wiring	PSHU31L000P	PSHU31L001P

Accessories - 15407-1, Non plug-in, Size DX02

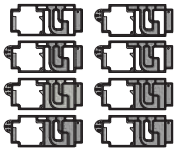
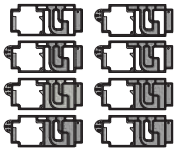
Accessories	Description	Part number		
	Gauge adapter kit Includes 1/8" coupling and long nipple	PS5651160P		
	Blanking plate kit	PS5634P		
	Sandwich flow control Do not use with Independent Port Sandwich Regulators.	PS5642P		
	Sandwich supply module	1/8" NPT	PS562600P	
		1/8" BSPP	PS562601P	
	Sandwich regulator	Common pressure	Independent pressure	
		2-60 PSIG w/ gauge	PS5637155P	PS5637255P
	Manifold to manifold gasket kits	5-125 PSIG w/ gauge	PS5637166P	PS5637266P
		Pilot open	Pilot blocked	
		#1, 3, 5 ports open	PSHU11P	PSHU15P
		Blocked #1 port	PSHU12P	PSHU16P
	Manifold to manifold gasket kits	Blocked #1, 3, 5, ports	PSHU13P	PSHU17P
		Blocked #3, 5 ports	PSHU14P	PSHU18P

 Most popular.



For inventory, lead times, and kit lookup, visit www.pdnplu.com

D233

Parker Hannifin Corporation
 Pneumatic Division
 Richland, Michigan
www.parker.com/pneumatics

D

Subbase & Manual Valves

H Series Micro

Modulflex Series

H Series ISO



Network Connectivity

DX ISOMAX Series



Valvair II Series

Common Part Numbers

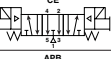
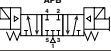
DX01 ISO Solenoid Valves

Symbol	Type	Cv	Operator	Pilot	Override	24 VDC	120 VAC
 Sol.14	4-way, 2-position, spring return	0.75	Single solenoid	Internal	Non-locking	DX01-621-951M	DX01-621-951J
 Sol.14	4-way, 2-position, air return	0.75	Single solenoid	Internal	Non-locking	DX01-651-951M	DX01-651-951J
 Sol.14	4-way, 2-position	0.75	Double solenoid	Internal	Non-locking	DX01-606-951M	DX01-606-951J
 Sol.14	4-way, 3-position, center exhaust	0.5	Double solenoid	Internal	Non-locking	DX01-611-951M	DX01-611-951J
 Sol.14	4-way, 3-position, all ports blocked	0.5	Double solenoid	Internal	Non-locking	DX01-616-951M	DX01-616-951J

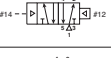
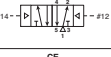

DX01 ISO Remote Pilot Valves

Symbol	Type	Cv	Operator	Pilot	Part Number
 #14	4-way, 2-position, spring return	0.75	Single remote pilot	Remote	DX01-421-60
 #14	4-way, 2-position, air return	0.75	Single remote pilot	Remote	DX01-451-60
 #14	4-way, 2-position	0.75	Double remote pilot	Remote	DX01-406-60
 #14	4-way, 3-position, center exhaust	0.5	Double remote pilot	Remote	DX01-411-60
 #14	4-way, 3-position, all ports blocked	0.5	Double remote pilot	Remote	DX01-416-60

Torque Specifications

DX02: 15 to 25 in-lbs (1.69 to 2.82 Nm) DX01: 20 to 30 in-lbs (2.26 to 3.39 Nm)

Base / End Plate - 15407-1, Non Plug-in, Size DX01

	Description	NPT	BSPP
 Single subbase	Side ported base, 1/4" port	PS5511130P	PS5511140P
 Universal manifold base	2 station, end ported	PSHU115301P	PSHU115401P
 Universal end plate	Non-collective wiring	PSHU31L000P	PSHU31L001P

 Most popular.



For inventory, lead times, and kit lookup, visit www.pdnplu.com





D234

Parker Hannifin Corporation
 Pneumatic Division
 Richland, Michigan
www.parker.com/pneumatics

D
 Subbase & Manual Valves
 H Series Micro
 Modulflex Series
 H Series ISO
 Network Connectivity
 DX ISOMAX Series
 Valvair-II Series

Common Part Numbers

Accessories - 15407-1, Non Plug-in, Size DX01

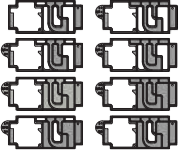
Accessories	Description	Part number	
	Blanking plate kit	PS5534P	
	Sandwich flow control	PS5542P	
	Sandwich Flow Control and Common Port Sandwich Regulator may be sandwiched together on a manifold or subbase. The Sandwich Flow Control MUST be located between the manifold/subbase and the Common Port Sandwich Regulator. Do not use with Independent Port Sandwich Regulators.		
	Pilot exhaust module	Pilot pressure control, without sensor, 1/8" BSPP PS55XA0P	
	Sandwich supply module	1/4" NPT	PS552600P
		1/4" BSPP	PS552601P
	Sandwich regulator	2-60 PSIG w/ gauge	PS5537155P
		5-125 PSIG w/ gauge	PS5537166P
		Common pressure	PS5537255P
		Independent pressure	PS5537266P
	Manifold to manifold gasket kits	Pilot open	Pilot blocked
		#1, 3, 5 ports open	PSHU11P
		Blocked #1 port	PSHU12P
		Blocked #1, 3, 5, ports	PSHU13P
		Blocked #3, 5 ports	PSHU14P
		PSHU15P	PSHU16P
		PSHU17P	PSHU18P

 Most popular.



For inventory, lead times, and kit lookup, visit www.pdnplu.com

D235

Parker Hannifin Corporation
 Pneumatic Division
 Richland, Michigan
www.parker.com/pneumatics

D

Subbase & Manual Valves

H Series Micro

Moduflex Series

H Series ISO

Network Connectivity

DX ISOMAX Series

Valvair II Series

Model Number

DX02 - 6 06 - 95 1 M

Basic Series	
ISO 15407-1 (18mm)	DX02
ISO 15407-1 (26mm)	DX01

Pilot	
Air Operated Remote Pilot	4
Solenoid Operated	6

Voltage & Frequency			
	AC		DC
	60Hz	50Hz	
J	120	110	
M			24
Blank	Remote Pilot		

Function	
Internal Pilot Supply / Captured Exhaust 12	
2-Position, Spring Return	21
2-Position, Air Return	51
2-Position	06
3-Position, CE	11
3-Position, APB	16
External Pilot 14 Supply / Captured Exhaust 12*	
2-Position, Spring Return	23
2-Position, Air Return	54
2-Position	05
3-Position, CE	09
3-Position, APB	19
Internal Pilot Supply / Vented Exhaust	
2-Position, Spring Return	20
2-Position, Air Return	50
2-Position	04
3-Position, CE	27
3-Position, APB	25
External Pilot Supply / Vented Exhaust*	
2-Position, Spring Return	22
2-Position, Air Return	53
2-Position	08
3-Position, CE	12
3-Position, APB	18

Override	
Blank	Remote Pilot
1	Non-Locking, Flush
3	Locking, Flush

Operator	
60	None, Remote Pilot Valve
95	15mm, 3-Pin, DIN 43650C

* Must be specified when using Sandwich Regulators.

Note: DX02 18mm Valve Remote Pilot Option only available with PL02 Individual Subbase Kits

D

Subbase & Manual Valves

H Series Micro

Modulflex Series

H Series ISO

Network Connectivity

DX ISOMAX Series

Valvair II Series



For inventory, lead times, and kit lookup, visit www.pdnplu.com

D236

Parker Hannifin Corporation
 Pneumatic Division
 Richland, Michigan
www.parker.com/pneumatics

Ordering Information

15407-1, DX02 & DX01 Manifold / Subbase Kits

PSHU1153 0 1 P

Mounting Style / Port Size	
DX02 manifold with 1/8 NPT end ports	PSHU1151
DX02 manifold with 1/8 BSPP end ports	PSHU1152*
DX01 manifold with 1/4 NPT end ports	PSHU1153
DX01 manifold with 1/4 BSPP end ports	PSHU1154*
DX1 manifold with 3/8 NPT end ports	PSHU1155
DX1 manifold with 3/8 BSPP end ports	PSHU1156*
DX2 manifold with 1/2 NPT end ports	PSHU1157
DX2 manifold with 1/2 BSPP end ports	PSHU1158*

* BSPP conforms to ISO 1179-1 w 228-1 threads.



DX01 manifold

Gasket Options	
1	1,3,5 ports open and pilots open
2	1,3,5 ports closed and pilots open
3	1 closed, 3,5 ports open and pilots closed
4	1 port open, 3,5 ports closed and pilots open
5	1,3,5 ports open and pilots closed
6	1,3,5 ports closed and pilots closed
7	1 closed, 3,5 ports open and pilots closed
8	1 port open, 3,5 ports closed and pilots open

Circuit Board Address Configuration	
0	No interconnect

Subbase Kit - Non Plug-in



HA non plug-in subbase shown

PS55 1113 0 P

Series	
DX01 Subbase	PS55
DX1 Subbase	PS40
DX2 Subbase	PS41

Engineering Level	
Blank	HA Series
D	H1 Series
C	H2 Series

Mounting Style / Port Size	
DX01 Series	
1/4 NPT side ports	1113
1/4 BSPP side ports	1114*
1/4 NPT bottom / side ports	1123
1/4 BSPP bottom / side ports	1124*
DX1 Series	
3/8 NPT side ports	1115
3/8 BSPP side ports	1116*
DX2 Series	
1/2 NPT side ports	1117
1/2 BSPP side ports	1118*

* BSPP conforms to ISO 1179-1 w 228-1 threads.

Enclosures / Lead Length	
0	None, No Electrical Plug

DX02 Series ISO 15407-1 Size 18mm (DX02) Single Subbase



DX01 Series Subbase

Side ported base
 18mm DX02 / HB

1/8" NPT	1/8" BSPP
PL02-01-80	PL02-01-70

Note: Can be used for external, single, or double remote pilot.

D

Subbase & Manual Valves

H Series Micro

Moduflex Series

H Series ISO

Network Connectivity

DX ISOMAX Series

Valvair II Series



For inventory, lead times, and kit lookup, visit www.pdnplu.com

D237

Parker Hannifin Corporation
 Pneumatic Division
 Richland, Michigan
www.parker.com/pneumatics

15407-1, DX02 & DX01 End Plate Kits



Left hand end plate

PSHU31 L0 0 0 P

Valve Type	
Non Plug-in (internal pilot)	PSHU31
Non Plug-in (external pilot)	PSHU3X

Left Hand End Plate Type	
Non Plug-in	L0

Thread Type	
0	NPT
1*	BSPP "G"

* BSPP Conforms to ISO 1179-1 w 228-1 Threads

Right Hand End Plate Type / Port	
0	Low profile (no ports)
1	1/2 Exhaust and inlet port
2	3/4 Exhaust and inlet port
5*	H3 Transition plate, 1" exhaust and inlet

* 1, 3 & 5 manifold galley blocked at transition plate. 12 & 14 pass through.

Right Hand End Plate



Low Profile



High Flow

Description	NPT port	BSPP port
Right hand end plate only, low profile	PSHU4000P	
Right hand end plate only, high flow 1/2" ports	PSHU4100P	PSHU4101P
Right hand end plate only, high flow 3/4" ports	PSHU4200P	PSHU4201P

H3 Transition Kit



Description	NPT port	BSPP port
H3 transition, H3 right hand end plate, 1" ports (includes gaskets & bolts)	PSU7300P	PSHU7301P

Manifold / Subbase Kit - Non Plug-in, 5599-1, Size 3 (H3)

PS421159 0 C P

Mounting Base Style / Port Size	
Subbase: 3/4 NPT side ports	PS421119
Subbase: 3/4 BSPP side port	PS421110*
Manifold: 3/4 NPT End port	PS421159
Manifold: 3/4 BSPP end port	PS421150*
Manifold: 3/4 NPT bottom / end port	PS421169
Manifold: 3/4 BSPP bottom / end port	PS421160*

* BSPP conforms to ISO 1179-1 w 228-1 threads.

Engineering Level	
C	H3

Enclosures / Lead Length	
0	None, No Electrical Plug - 5599-1



H3 Subbase shown



H3 Manifold shown



For inventory, lead times, and kit lookup, visit www.pdnplu.com

D238

Parker Hannifin Corporation
 Pneumatic Division
 Richland, Michigan
www.parker.com/pneumatics

D
 Subbase & Manual Valves
 H Series Micro
 Modulflex Series
 H Series ISO
 Network Connectivity
 DX ISOMAX Series
 Valvair II Series

Sandwich Regulators Features

- Remote Air Pilot Operated for hard-to-reach pressure control.
- Unregulated Pilot Pressure to valve for consistent valve shifting regardless of pressure adjustment.

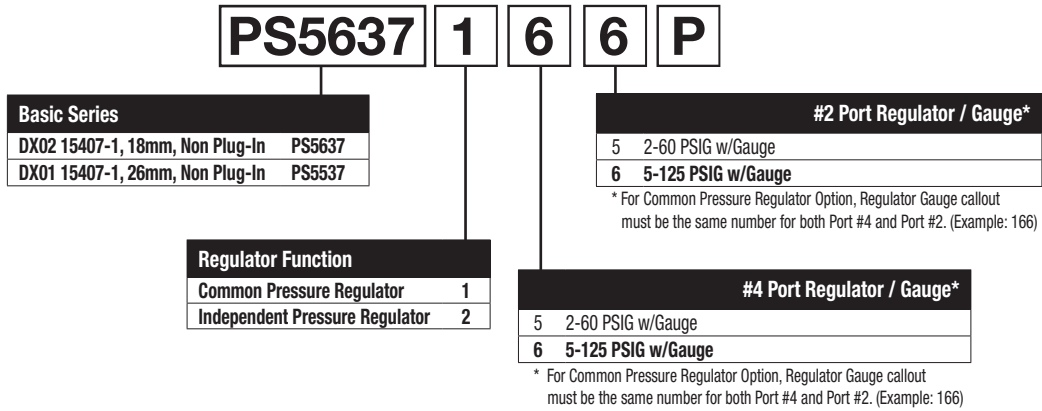

DX02
 (Independent Dual Port Regulator Shown)

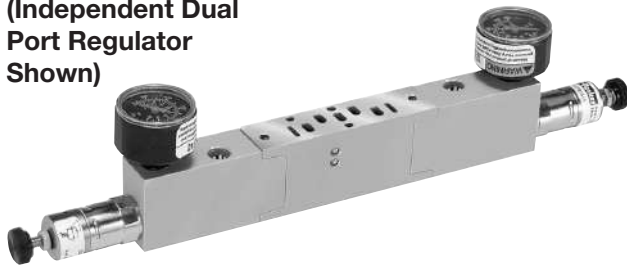

DX01
 (Common Port Regulator Shown)

Ordering Components

- Manifold or Subbase Kit required.
- Sandwich Regulator Kit configured for Internal Pilot as standard.
- Order valve as External Pilot.

How to Configure Sandwich Regulator / Valve Combinations

Internal Pilot Configuration of Sandwich Regulator HA, HB

Pressure in Base Port 1 feeds regulator configured for Internal Pilot which feeds valve configured for External Pilot.

Accessories	Description	Part number
 Gauge adapter kit	Includes 1/8" coupling, long nipple, and gauge	PS5651160P

Sandwich Regulator Cv Flow Chart*

	Common Pressure Code 166				Dual Pressure Code 266			
	1-2	1-4	2-3	4-5	1-2	1-4	2-3	4-5*
HB	0.20	0.20	0.41	0.34	0.23	0.19	0.28	0.27
HA	0.41	0.43	0.87	0.89	0.42	0.45	0.68	0.66

* Regulator Port exhaust through Base Port 3.
 Note: All Cv's calculated with regulator adjusted full open.

Remote Pilot Access Plate Kit

Size	Port size	Part number	
		NPT	BSPP
26mm DX01	1/8"	PS551500P	PS551501P



For inventory, lead times, and kit lookup, visit www.pdnplu.com

D239

Parker Hannifin Corporation
 Pneumatic Division
 Richland, Michigan
www.parker.com/pneumatics

D

Subbase & Manual Valves

H Series Micro

Modulflex Series

H Series ISO

Network Connectivity

DX ISOMAX Series

Valvair II Series

DX02 Series Subbase & Manifolds

Single Subbase

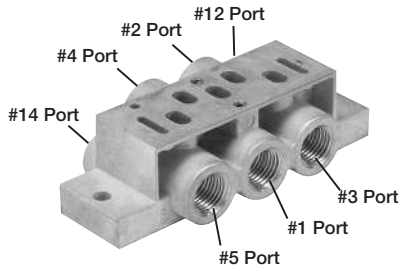

Side Ported Base
 18mm DX02

1/8" NPT	1/8" BSPP
PL02-01-80	PL02-01-70

Note: Can be used for external, single, or double remote pilot.

2 Station Manifold Bases

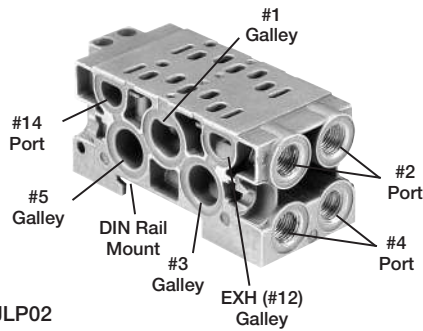

End Ported Bases
 18mm DX02

1/8" NPT	1/8" BSPP
PJLP02-201-80	PJLP02-201-70

Note: Can be used for external pilot, not remote pilot. Gaskets and assembly hardware included.

PJLP02

End Plate Kit

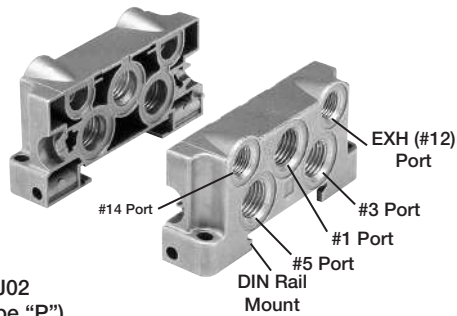

Side Ported Two Station
 Manifold Base
 18mm DX02

1/4" NPT Port	1/4" BSPP Port
PEJ02-02-80*	PEJ02-02-70

***Note:** Put a vent or muffler in "EXH" port when capturing pilot exhaust pressure with a solenoid valve. (See gasket selector page for details.) Gaskets and assembly hardware included.
 Torque Specifications: 25 to 35 in-lbs (2.82 to 3.95 Nm)

PEJ02
 (Type "P")

D
 Subbase & Manual Valves
 H Series Micro
 Modulflex Series
 H Series ISO
 Network Connectivity
 DX ISOMAX Series
 Valvair II Series

Most popular.



For inventory, lead times, and kit lookup, visit www.pdnplu.com

D240

Parker Hannifin Corporation
 Pneumatic Division
 Richland, Michigan
www.parker.com/pneumatics

DX01 Series Subbase & Manifolds

Single Subbase

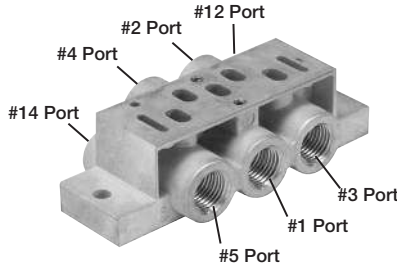

Side ported base
 26mm DX01

Part number

1/4" NPT	1/4" BSPP
PL01-02-80	PL01-02-70

Note: Can be used for external, single, or double remote pilot.

2 Station Manifold Bases

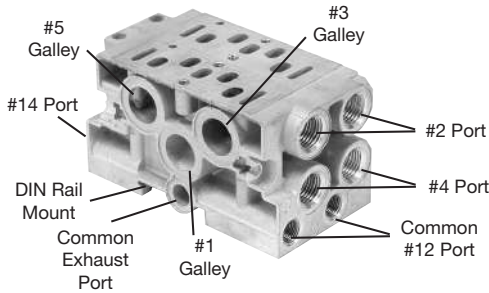

End ported bases
 26mm DX01

1/4" NPT 1/4" BSPP

PJLP01-202-80	PJLP01-202-70
----------------------	----------------------

Note: Can be used for single remote pilot using the #14 Port and external pilot. Gaskets and assembly hardware included.

PJLP01

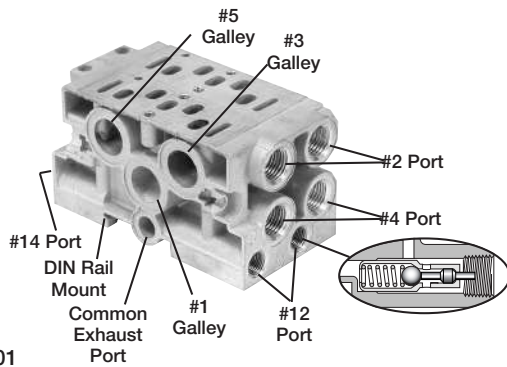

End ported bases
 26mm DX01

1/4" NPT 1/4" BSPP

PJL01-202-80	PJL01-202-70
---------------------	---------------------

Notes: #12 ports work independently when plunger is not depressed by a plug. When a plug is inserted in #12 Port along with the captured pilot exhaust gasket selector option, pilot exhaust is sent to the Common Exhaust Port. Do Not plug exhaust, insert a vent of muffler.

Gaskets and assembly hardware included. Can be used for external, single or double remote pilot.

PJL01

End Plate Kit

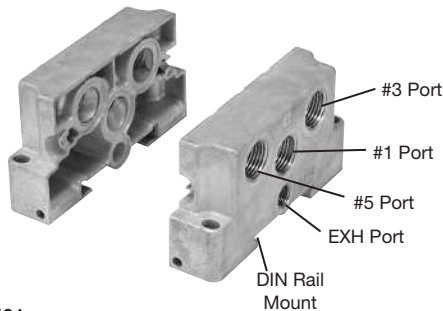

Side ported two station manifold base
 26mm DX01

3/8" NPT port 3/8" BSPP port

PEJ01-03-80*	PEJ01-03-70
---------------------	--------------------

* Use with PJLP01 or PJL01

Notes: Put a vent or muffler in "EXH" port when capturing pilot exhaust pressure with a solenoid valve. (See gasket selector page for details.) Gaskets and assembly hardware included. Torque Specifications: 25 to 35 in-lbs (2.82 to 3.95 Nm)

PEJ01

Most popular.



For inventory, lead times, and kit lookup, visit www.pdnplu.com

D241

Parker Hannifin Corporation
 Pneumatic Division
 Richland, Michigan
www.parker.com/pneumatics

D

Subbase & Manual Valves

H Series Micro

Moduflex Series

H Series ISO

Network Connectivity

DX ISOMAX Series

Valvair II Series

Accessories

Intermediate Air Supply Base



Size	Port size	Part number
18mm DX02	1/8" NPT	D02P-01-80
26mm DX01	1/4" NPT	D01P-02-80

Notes: Gasket & Mounting Bolts included.
Torque Specifications
Size 02: 15 to 25 in-lbs (1.69 to 2.82 Nm)
Size 01: 20 to 30 in-lbs (2.26 to 3.39 Nm)

Manifold Port Isolation Disc

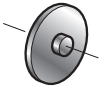

Size		Part number
18mm DX02	Common Pressure	D02BD0
26mm DX01		D01BD0

Notes: 3 Discs per Kit.
Used on PJJ Manifolds.

Blanking Plate



Size		Part number
18mm DX02	Common Pressure	PS5634P
26mm DX01		PS5534P

Notes: Gasket & Mounting Bolts included.
Torque Specifications
Size 02: 15 to 25 in-lbs (1.69 to 2.82 Nm)
Size 01: 20 to 30 in-lbs (2.26 to 3.39 Nm)

Sandwich Flow Control Features



**DX02
18mm Shown**

Size	Part number
18mm DX02	PS5642P
26mm DX01	PS5542P

- Both adjustment screws are located on the 12 end of the unit.
- Sandwich Flow Control mounts with its own studs, which means the valve uses standard bolts for mounting.
- Sandwich Flow Control is not to be used as a shut off device and is not bubble tight when needles are fully turned down.
- Do not use with Independent Port Sandwich Regulators.

Manifold to Manifold Gasket Kits



DX02M2MGSKT (PJLP02)



DX01M2MGSKT (PJLP01)

Size	Standard	Blocked #1 Port	Blocked #1, 3, 5 Ports	Blocked #3, 5 Ports
DX02*	PS561AP	PS561BP	PS561CP	PS561DP
DX01*				

DX02 **DX02M2MGSKT (PJLP02)**

DX01 **DX01M2MGSKT (PJLP01)**

* Gaskets used with PS5611 & PS5511 Manifolds.

Manifold Hardware Kits

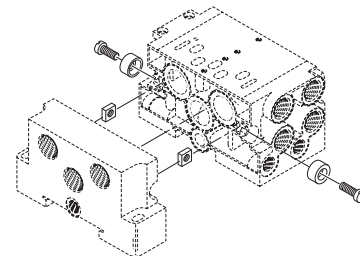

Description	Part number
Bolt, Washer & Nut*	DX02M2MB**
Tie Rods for PS5611 Manifold (Qty. 12)	PS5612P
Tie Rods for PS5511 Manifold (Qty. 12)	PS5512P

* Includes 10 Bolts, 10 Washers, 10 Nuts

** Use this number for both sizes, PJLP02 & PJLP01.

Torque Specifications: 25 to 35 in-lbs (2.82 to 3.95 Nm)

D
Subbase & Manual Valves
H Series Micro
Modulflex Series
H Series ISO
Network Connectivity
DX ISOMAX Series
Valvair II Series



For inventory, lead times, and kit lookup, visit www.pdnplu.com

Common Part Numbers

DX1 ISO Solenoid Valves

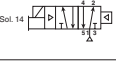
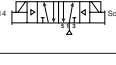
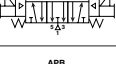
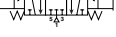

Symbol	Type	Cv	Operator	Pilot	Override	24 VDC	120 VAC
	4-way, 2-position, spring return	1.15	Single solenoid	Internal	Non-locking	DX1-621-BL49	DX1-621-BL53
					Locking	DX1-621-CL49	DX1-621-CL53
	4-way, 2-position, air return	1.15	Single solenoid	Internal	Non-locking	DX1-651-BL49	DX1-651-BL53
					Locking	DX1-651-CL49	DX1-651-CL53
	4-way, 2-position	1.15	Double solenoid	Internal	Non-locking	DX1-606-BL49	DX1-606-BL53
					Locking	DX1-606-CL49	DX1-606-CL53
	4-way, 3-position, center exhaust	0.75	Double solenoid	Internal	Non-locking	DX1-611-BL49	DX1-611-BL53
					Locking	DX1-611-CL49	DX1-611-CL53
	4-way, 3-position, all ports blocked	0.75	Double solenoid	Internal	Non-locking	DX1-616-BL49	DX1-616-BL53
					Locking	DX1-616-CL49	DX1-616-CL53

30mm 3-Pin Solenoid, NLMOR, Unlighted, Internal Pilot, Valve Less Base

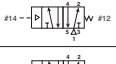
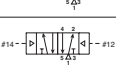
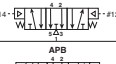

DX1 ISO Remote Pilot Valves

Symbol	Type	Cv	Operator	Pilot	Part Number
	4-way, 2-position, spring return	1.15	Single remote pilot	Remote	DX1-421-60
					DX1-451-60
	4-way, 2-position, air return	1.15	Single remote pilot	Remote	DX1-406-60
					DX1-411-60
	4-way, 3-position, center exhaust	0.75	Double remote pilot	Remote	DX1-416-60
					DX1-416-60

Base / End Plate - 5599-1, Non Plug-in, Size 1 DX1

	Description	NPT	BSPP
 Single subbase	Side ported, 3/8" port	PS4011150DP	PS4011160DP
 Universal manifold base	End ported	PSHU115501P	PSHU115601P
 Universal end plate	Non-collective wiring	PSHU31L000P	PSHU31L001P

Accessories - 5599-1, Non Plug-in, Size 1 DX1

Accessory	Description	Part number
 Sandwich regulator	Common pressure	5-125 PSIG w/ gauge PS4037166CP
	Independent pressure	5-125 PSIG w/ gauge PS4037266CP
 Blanking plate kit		PS4034CP
 Sandwich flow control		PS4042CP

Sandwich Flow Control and Common Port Sandwich Regulator may be sandwiched together on a manifold or subbase. The Sandwich Flow Control MUST be located between the manifold/subbase and the Common Port Sandwich Regulator. Do not use with Independent Port Sandwich Regulators.

 Most popular.



For inventory, lead times, and kit lookup, visit www.pdnplu.com

D243

Parker Hannifin Corporation
 Pneumatic Division
 Richland, Michigan
www.parker.com/pneumatics

D

Subbase & Manual Valves

H Series Micro

Modulflex Series

H Series ISO

Network Connectivity

DX ISOMAX Series



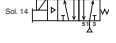
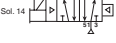
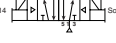
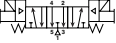
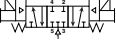

Valvair II Series

Common Part Numbers

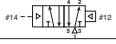

DX2 ISO Valves

Symbol	Type	Cv	Operator	Pilot	Override	24 VDC	120 VAC
	4-way, 2-position, spring return	2.5	Single solenoid	Internal	Non-locking	DX2-621-BL49	DX2-621-BL53
					Locking	DX2-621-CL49	DX2-621-CL53
	4-way, 2-position, air return	2.5	Single solenoid	Internal	Non-locking	DX2-651-BL49	DX2-651-BL53
					Locking	DX2-651-CL49	DX2-651-CL53
	4-way, 2-position	2.5	Double solenoid	Internal	Non-locking	DX2-606-BL49	DX2-606-BL53
					Locking	DX2-606-CL49	DX2-606-CL53
	4-way, 3-position, center exhaust	2.4	Double solenoid	Internal	Non-locking	DX2-611-BL49	DX2-611-BL53
					Locking	DX2-611-CL49	DX2-611-CL53
	4-way, 3-position, all ports blocked	2.4	Double solenoid	Internal	Non-locking	DX2-616-BL49	DX2-616-BL53
					Locking	DX2-616-CL49	DX2-616-CL53



DX2 ISO Remote Pilot Valves

Symbol	Type	Cv	Operator	Pilot	Part Number
	4-way, 2-position, spring return	2.5	Single remote pilot	Remote	DX2-421-60
	4-way, 2-position, air return	2.5	Single remote pilot	Remote	DX2-451-60
	4-way, 2-position	2.5	Double remote pilot	Remote	DX2-406-60
	4-way, 3-position, center exhaust	2.4	Double remote pilot	Remote	DX2-411-60
	4-way, 3-position, all ports blocked	2.4	Double remote pilot	Remote	DX2-416-60

Base / End Plate - 5599-1, Non Plug-in, Size 2 DX2

	Description	1/2" NPT	1/2" BSPP	
	Single subbase	Side ported, 1/2" port	PS4111170CP	PS4111180CP
	Universal manifold base	End ported	PSHU115701P	PSHU115801P
	Universal end plate	Non-collective wiring	PSHU31L000P	PSHU31L001P

Accessories - 5599-1, Non Plug-in, Size 2 DX2

Accessory	Description	Part number	
	Common pressure	5-125 PSIG w/ gauge	PS4137166CP
	Independent pressure	5-125 PSIG w/ gauge	PS4137266CP
	Blanking plate kit	PS4134CP	
	Sandwich flow control	PS4142CP	
Sandwich Flow Control and Common Port Sandwich Regulator may be sandwiched together on a manifold or subbase. The Sandwich Flow Control MUST be located between the manifold/subbase and the Common Port Sandwich Regulator. Do not use with Independent Port Sandwich Regulators.			

 Most popular.

D
 Subbase & Manual Valves
 H Series Micro
 Modulflex Series
 H Series ISO
 Network Connectivity
 DX ISOMAX Series
 Valvair II Series





For inventory, lead times, and kit lookup, visit www.pdnplu.com

D244

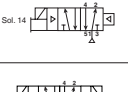

Parker Hannifin Corporation
 Pneumatic Division
 Richland, Michigan
www.parker.com/pneumatics

Common Part Numbers

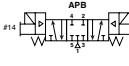

DX3 ISO Valves

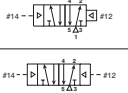
Symbol	Type	Cv	Operator	Pilot	Override	24 VDC	120 VAC
 Sol. 14	4-way, 2-position, spring return	4.15	Single solenoid	Internal	Non-locking	DX3-621-BL49	DX3-621-BL53
					Locking	DX3-621-CL49	DX3-621-CL53
 Sol. 14	4-way, 2-position, air return	4.15	Single solenoid	Internal	Non-locking	DX3-651-BL49	DX3-651-BL53
					Locking	DX3-651-CL49	DX3-651-CL53
 Sol. 14 Sol. 12	4-way, 2-position	4.15	Double solenoid	Internal	Non-locking	DX3-606-BL49	DX3-606-BL53
					Locking	DX3-606-CL49	DX3-606-CL53
 CE #14 #120	4-way, 3-position, center exhaust	4.0	Double solenoid	Internal	Non-locking	DX3-611-BL49	DX3-611-BL53
					Locking	DX3-611-CL49	DX3-611-CL53
 APB #14 #120	4-way, 3-position, all ports blocked	4.0	Double solenoid	Internal	Non-locking	DX3-616-BL49	DX3-616-BL53
					Locking	DX3-616-CL49	DX3-616-CL53

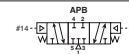
DX3 ISO Remote Pilot Valves

Symbol	Type	Cv	Operator	Pilot	Part Number
 #14 #12	4-way, 2-position, spring return	4.15	Single remote pilot	Remote	DX3-421-60
					DX3-451-60
 #14 #12	4-way, 2-position, air return	4.15	Single remote pilot	Remote	DX3-406-60
					DX3-411-60
 #14 #120	4-way, 3-position, center exhaust	4.0	Double remote pilot	Remote	DX3-416-60
					DX3-421-60
 #14 #120	4-way, 3-position, all ports blocked	4.0	Double remote pilot	Remote	DX3-416-60
					DX3-421-60

DX3 Series Subbase & Manifolds

Single subbase	Description	3/4" NPT	3/4" BSPP
	Side ported base	PS4211190CP	PS4211100CP
Manifold bases	Description	3/4" NPT	3/4" BSPP
	Bottom / End ported bases Note: Manifolds include 2 pipe plugs	PS4211690CP	PS4211600CP
End plate kits	Description	NPT port	BSPP port
	H3 Non-collective wiring end plates	PS4231010DP	PS4231011DP

5599-1, DX3 Accessories

Accessories	Description	Part Number
Sandwich regulator 	Common pressure 5-125 PSIG w/ gauge	PS4237166CP
	Independent pressure 5-125 PSIG w/ gauge	PS4237266CP
Manifold to manifold gasket kit		PS4213P

 Most popular.



For inventory, lead times, and kit lookup, visit www.pdnplu.com

D245

Parker Hannifin Corporation
 Pneumatic Division
 Richland, Michigan
www.parker.com/pneumatics

D

Subbase & Manual Valves

H Series Micro

Modulflex Series

H Series ISO

Network Connectivity

DX ISOMAX Series

Valvair II Series

DX1

6 21

B L 53

Basic Series	
ISO 5599-1	DX1 - Size 1
ISO 5599-1	DX2 - Size 2
ISO 5599-1	DX3 - Size 3

Pilot	
Air Operated Remote Pilot	4
Solenoid Operated	6

Voltage & Frequency			
	AC		DC
	60Hz	50Hz	
19*			24
49			24
53	120	110	
Blank	Remote Pilot or Valve Less Coil		

* LED & Surge Suppression.
 Only Available with Enclosure "6".

Function	
Internal Pilot Supply	
2-Position, Spring Return, Air Assist	21
2-Position, Diff Return	51
2-Position	06
3-Position, CE	11
3-Position, APB	16
3-Position, PC	13*
External Pilot Supply†	
2-Position, Spring Return, Air Assist	22
2-Position, Diff Return	53
2-Position	08
3-Position, CE	12
3-Position, APB	18
3-Position, PC	24*

* Not offered with DX3 Valves.
 † Must be specified when using Sandwich Regulators.

5599-1 Enclosure / Lead Length / Light	
0**	None, Remote Pilot Valve
6*	2-Pin, M12 EURO Connector with CNOMO Operator, Light
L	3-Pin, 30mm DIN 43650A with CNOMO Connector, No Light
P	3-Pin, 22mm Industrial with CNOMO Connector, No Light
N†	None, Valve Less Coil, No Light

* Only available with Voltage & Frequency "19".

**Must use Overrides Option "6".

† Must use Overrides Option "B" or "C".

5599-1 Overrides	
6	Remote Pilot / Without Solenoid
B	Non-Locking, Flush, Push
C	Locking, Flush, Push / Turn

D

Subbase & Manual Valves

H Series Micro

Modulflex Series

H Series ISO

Network Connectivity

DX ISOMAX Series

Valvair II Series



For inventory, lead times, and kit lookup, visit www.pdnplu.com

Non-Plug-in, 5599-1, End Plate Kits

PS423101 0 C P

Basic Series	
ISO 5599, Size 3	PS423101

Thread Type	
0	NPT
1*	BSPP "G"

* BSPP Conforms to ISO 1179-1 w 228-1 Threads.

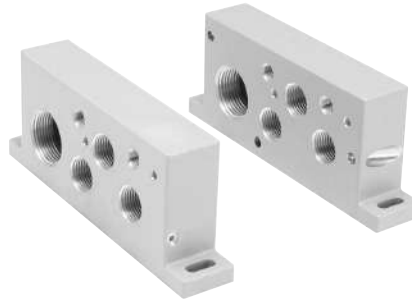

H1 Non-Collective Wiring End Plates

D

Subbase & Manual Valves

H Series Micro

Moduflex Series

H Series ISO

Network Connectivity

DX ISOMAX Series

Valvair II Series



For inventory, lead times, and kit lookup, visit www.pdnplu.com

D247

Parker Hannifin Corporation
 Pneumatic Division
 Richland, Michigan
www.parker.com/pneumatics

Ordering Information

Sandwich Regulators Features

- Remote Air Pilot Operated for hard-to-reach pressure control.
- Unregulated Pilot Pressure to valve for consistent valve shifting regardless of pressure adjustment.

PS4037 1 6 6 C P

Basic Series	
H1 5599-1, Non Plug-in	PS4037
H2 5599-1, Non Plug-in	PS4137

Regulator Function	
Common Pressure Regulator	1
Independent Pressure Regulator	2

#2 Port Regulator / Gauge*	
0**	Line By-Pass Plate
4	1-30 PSIG w/Gauge
5	2-60 PSIG w/Gauge
6	5-125 PSIG w/Gauge
D	Remote Pilot ISO 2 & 3 only

* For common pressure regulator option, regulator gauge callout must be the same number for both Port #4 and Port #2. (Example: 166)

** Pressure Line by-pass option can only be used with independent pressure regulators.

#4 Port Regulator / Gauge*	
0**	Line By-Pass Plate
4	1-30 PSIG w/Gauge
5	2-60 PSIG w/Gauge
6	5-125 PSIG w/Gauge
D	Remote Pilot ISO 2 & 3 only

* For common pressure regulator option, regulator gauge callout must be the same number for both Port #4 and Port #2. (Example: 166)

** Pressure Line by-pass option can only be used with independent pressure regulators.

D
 Subbase & Manual Valves
 H Series Micro
 Modulflex Series
 H Series ISO
 Network Connectivity
 DX ISOMAX Series
 Valvair II Series

DX1 - Size 1
 (Independent Dual Port Regulator Shown)



DX2 - Size 2
 (Independent Dual Port Regulator Shown)



Ordering Components

- Manifold or Subbase Kit required.
- Sandwich Regulator Kit configured for Internal Pilot as standard.
- Order valve as External Pilot.

How to Configure Sandwich Regulator / Valve Combinations

Internal Pilot Configuration -

Pressure in Base Port 1 feeds regulator configured for Internal Pilot which feeds valve configured for External Pilot.

External Pilot Configuration - DX1, DX2, DX3

An External Pilot pressure in Port 12 or 14 of the base feeds thru the Sandwich Regulator 12 or 14 galley directly to the 12/14 pilot of the valve. This configuration takes an External Pilot from the 12 port of the base and passes it thru the regulator to feed the 12 galley of the valve.

Note: Do not use Independent Port Sandwich Regulators with Sandwich Flow Controls.

Independent Port Sandwich Port Regulators combine the #3 and #5 valve exhaust ports into the #5 exhaust at the manifold/subbase interface. The #3 port flow control will control both #3 and #5 exhaust. #5 port flow control is ineffective.

Sandwich Regulator Cv Flow Chart*

	Common Pressure Code 166				Single Pressure 2 Code 206				Single Pressure 4 Code 260				Dual Pressure Code 266			
	1-2	1-4	2-3	4-5	1-2	1-4	2-3	4-5*	1-2	1-4	2-3	4-5*	1-2	1-4	2-3	4-5*
H1	0.62	0.61	1.28	1.18	0.73	0.96	0.96	0.93	0.34	0.70	0.94	0.98	0.52	0.48	0.86	0.88
H2	1.47	1.60	2.41	2.33	1.71	1.90	1.52	1.75	1.74	1.67	1.73	1.79	1.61	1.62	1.50	1.67

* Regulator Port exhaust through Base Port 3.

Note: All Cv's calculated with regulator adjusted full open.

Most popular.





For inventory, lead times, and kit lookup, visit www.pdnplu.com

D248

Parker Hannifin Corporation
 Pneumatic Division
 Richland, Michigan
www.parker.com/pneumatics

5599-1 Compact Manifolds, Subbases & Accessories

Manifold VDMA – Form C			Part Number
	Bottom Port	Size	Port size
		DX1	1/4"
		DX2	3/8"
		DX3	1/2"
			BSPP G
			P2N-VM512MB
			P2N-WM513MB
			P2N-YM514MB

VDMA End Plates – Form D			Part Number
	Size	Port size	BSPP G
	DX1	3/8"	P2N-VM513ES
	DX2	1/2"	P2N-WM514ES
	DX3	1"	P2N-YM518ES

Subbase – Side Ports (5599-1 & VDMA)	Size	Port Size	5599-1 Part Number		VDMA Part Number
			NPT	BSPP “G”	BSPP “G”
	DX1	1/4"	PL1-1/4-80	PL1-1/4-70	P2N-VS512SD
	DX2	3/8"	PL2-3/8-80	PL2-3/8-70	P2N-WS513SD
	DX3	1/2"	PL3-1/2-80	PL3-1/2-70	P2N-YS514SD

Subbase – Bottom Ports	Size	Port size	5599-1 Part Number	
			NPT	BSPP “G”
	DX1	1/4"	PD1-1/4-80	PD1-1/4-70
	DX2	3/8"	PD2-3/8-80	PD2-3/8-70

VDMA Transition Plate	Part Number
 <small>DX1 (Not Included) Transition Plate DX3 (Not Included)</small>	P2N-VM500AK
	Kit includes: Transition Plate Only. Order P2N-VM513ES and P2N-YM518ES Separately to Assemble Add-A-Fold

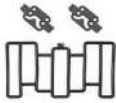
External Seal Kit	Size	Part Number
	DX1	JJDX10-A
	DX2	JJDX20-A
	DX3	JJDX30-A

Complete Seal Kit	Size	Part Number
	DX1	JJDX15-A
	DX2	JJDX25-A
	DX3	JJDX35-A

D

Subbase & Manual Valves

H Series Micro

Modulflex Series

H Series ISO

Network Connectivity

DX ISOMAX Series

Valvair II Series



For inventory, lead times, and kit lookup, visit www.pdnplu.com

Accessories

Blanking Plate Kits



Size	Part Number
DX1	PS4034CP
DX2	PS4134CP
DX3	PS4234CP

Kit includes:
 Blanking Plate, Gasket, and Mounting Bolts.

Remote Pilot Access Plate Kits

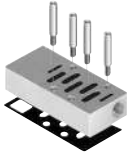

Size	Port Size	BSPP "G"
DX1	1/8"	PS401501CP
DX2	1/8"	PS411501CP
DX3	1/8"	PS421501CP

Kit includes: Pilot Port Access Plate, Gasket and Mounting Studs.

Manifold Port Isolation Kits

Main Galley (1, 3, 5)

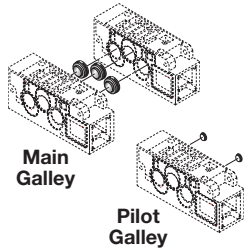

Size	P2N Manifolds
DX1	P2N-VK0P
DX2	P2N-WK0P
DX3	P2N-YK0P

Kit includes: Plugs with O-rings.

Pilot Galley

Size	Part Number
DX3	PS4033CP

Kit includes: Plugs with O-rings.
 For use with PS4 Series Manifolds.

Sandwich Flow Controls Features



Size	Part Number
DX1	PS4042CP
DX2	PS4142CP
DX3	PS4242CP

- Both adjustment screws are located on the 12 end of the unit.
- Sandwich Flow Control mounts with its own studs, which means the valve uses standard bolts for mounting.
- Sandwich Flow Control is not to be used as a shut off device and is not bubble tight when needles are fully turned down.
- Do not use with Independent Port Sandwich Regulators.

22mm Rectangular 3-Pin – Type B Industrial

(Use with Enclosure "B")

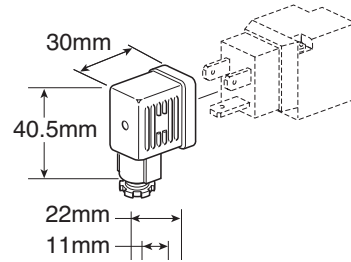

Description	Connector	Connector with 6' (2m) Cord
Unlighted	PS2429BP	PS2429JBP
Light – 24V60Hz, 24VDC	PS243079BP	PS2430J79BP*
Light – 120V/60Hz	PS243083BP	PS2430J83BP*
Light – 240V/60Hz	PS243087BP	N/A

* LED with surge suppression.

Note: Max ϕ 6.5mm cable size required for connector w/o 6' (2m) cord. IP65 rated when properly installed.

Engineering Data:

Conductors: 2 Poles Plus Ground; Cable Range (Connector Only): 6 to 8mm (0.24 to 0.31 Inch); Contact Spacing: 11mm

CNOMO Operator Adapter



Size	Part Number
DX1, DX2, DX3	PS2855P

D
 Subbase & Manual Valves
 H Series Micro
 Modulflex Series
 H Series ISO
 Network Connectivity
 DX ISOMAX Series
 Valvair II Series



For inventory, lead times, and kit lookup, visit www.pdnplu.com

15mm 3-Pin DIN 43650C Replacement Solenoid Kits

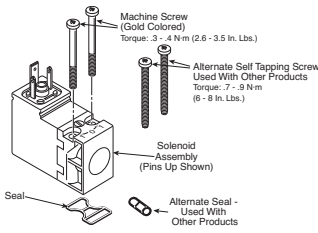

Voltage	Non-Locking	Locking
24VDC	PS2982B49P	PS2982C49P
110/50, 120/60	PS2982B53P	PS2982C53P

15mm 3-Pin DIN 43650C Connectors

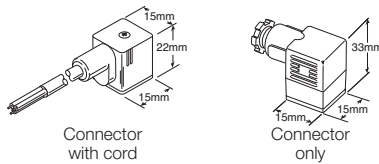

Description	Connector with 6' (2m) Cord	Connector
No circuit board	PS2932JBP	PS2932BP
Light - 24DC	PS2946J79BP*	PS294679BP
Light - 110/120VAC	PS2946J83BP*	PS294683BP

* LED with surge suppression.

Note: Max. ø6.5mm cable size required for connector without 6' (2m) cord. IP65 rated when properly installed.

Engineering Data:

Conductors: 2 poles plus ground
 Cable range (Connector only): 4 to 6mm (0.16 to 0.24 Inch)
 Contact spacing: 8mm

Female Electrical Connectors (IP65 Rated) 30mm, 3-Pin ISO 4400, (DIN 43650A)

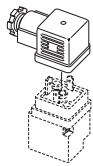

Description	Connector with 6' (2m) cord	Connector
Unlighted	PS2028JCP	PS2028BP
Light - 6-48V, 50/60Hz; 6-48VDC	PS2032J79CP*	PS203279BP
Light - 120V/60Hz	PS2032J83CP*	PS203283BP
Light - 240V/60Hz	N/A	PS203283BP

* With surge suppression.

Engineering data:

Conductors: 2 poles plus ground; cable range (connector only): 8 to 10mm (0.31 To 0.39 inch); Contact spacing: 18mm

5599-1 CNOMO Solenoid Kits

Voltage Code	3-pin, 30mm 'L' Coil Kit	2-pin, M12 Euro '6' coil Kit
19	—	PS2828619P
42	P2FCA442	—
45	P2FCA445	—
49	P2FCA449	—
53	P2FCA453	—
57	P2FCA457	—

Quantity 1

Pilot Operator - CNOMO

Valve size	Kit Number
DX1, DX2 & DX3	Locking PS4052CP
	Non-locking PS4053CP



For inventory, lead times, and kit lookup, visit www.pdnplu.com

D251

Parker Hannifin Corporation
 Pneumatic Division
 Richland, Michigan
www.parker.com/pneumatics

D

Subbase & Manual Valves

H Series Micro

Moduflex Series

H Series ISO

Network Connectivity

DX ISOMAX Series

Valvair II Series

Ceramic Technology / Valve Specifications

- Subbase Mounted Valves Conforming to ISO Standard 5599/1
- High Flow: DX1 (1.15 Cv), DX2 (2.50 Cv), DX3 (4.15 Cv)
- Air or Solenoid Operation Using CNOMO Solenoids
- Can Be Vacuum Operated

Air Condition:
 Filtered to 40µ

Dual Pressure Supply from Exhaust Ports:
 Yes - Without additional pressure at 12 and 14

Dust and Water Protection:
 IP65 (According to EN 60529)

Mechanical Life:
 > 100 million operations (Dry air filtered 40 µ, 2 Hz, 6 bar, 20°C)

Media:
 Air or inert gas, filtered 40 µ (Class 5 according to ISO 8573-1), lubricated or non-lubricated

Operating Temperature Range:
 -10°C to 60°C (14°F to 140°F)

Flow Rating (Cv)

Size	Port Size	Mounting Style	Flow Rating (Cv)	
			2-Position	3-Position
DX1	1/4" Ports	Subbase	1.15	0.75
	1/4" Ports	Manifold	0.80	0.60
DX2	3/8" Ports	Subbase	2.50	2.40
	3/8" Ports	Manifold	2.05	1.95
DX3	1/2" Ports	Subbase	4.15	4.00
	1/2" Ports	Manifold	4.10	3.65

Cv tested per ANSI / (NFPA) T3.21.3

Flow Rating (Cv) with Sandwich Regulator

Size	Common Pressure				Dual Pressure			
	1-2	1-4	2-3	4-5	1-2	1-4	2-3	4-5
DX1	0.55	0.49	1.06	1.02	0.32	0.42	0.25	0.38
DX2	1.06	1.05	2.33	2.17	0.93	0.66	0.77	1.15

Note: All Cv's calculated with regulator adjusted full open.

Response Time**

Single Solenoid 2-Position -
 Air Return / Spring Assist

Size	Port Size	0 Cu. In. Chamber		## Cu. In. Chamber	
		Fill	Exhaust	Fill	Exhaust
DX1	1/4"	.025	.030	.160	.235
DX2	3/8"	.040	.045	.170	.235
DX3	1/2"	.060	.065	.245	.330

DX1 (50), DX2 (100), DX3 (200)

** With 100 PSIG supply, time required to fill from 0 to 90 PSIG and Exhaust from 100 PSIG to 10 PSIG measured from the instant of energizing or de-energizing 24VDC solenoid.

Tested per ANSI / (NFPA) T3.21.8

Solenoid Information

Code	Voltage			Power (W / VA)
	AC			
	60Hz	50Hz	DC	
19	—	—	24	2.8W
49	—	—	24	2.7W
53	120	115	—	3.7VA

Data tested with LED and Surge Suppression.

Operating Pressure

Vacuum to 145 PSIG (10 bar)

Function	M.O.P. (PSIG)		
	DX1	DX2	DX3
Internal Pilot			
21 2-Position, Spring Return	36	30	30
51 2-Position, Air Return	30	30	30
06 2-Position	15	15	15
11 3-Position, CE	45	36	36
16 3-Position, APB	45	36	36
13 3-Position, PC	45	36	—
External Pilot			
22 2-Position, Spring Return	36	30	30
53 2-Position, Air Return	30	30	30
08 2-Position	15	15	15
12 3-Position, CE	45	36	36
18 3-Position, APB	45	36	36
24 3-Position, PC	45	36	—

D
 Subbase & Manual Valves
 H Series Micro
 Modulflex Series
 H Series ISO
 Network Connectivity
 DX ISOMAX Series
 Valvair II Series



For inventory, lead times, and kit lookup, visit www.pdnplu.com

DX ISOMAX Selector Gasket Conversion Instructions

Changing from Internal to External Pilot Supply

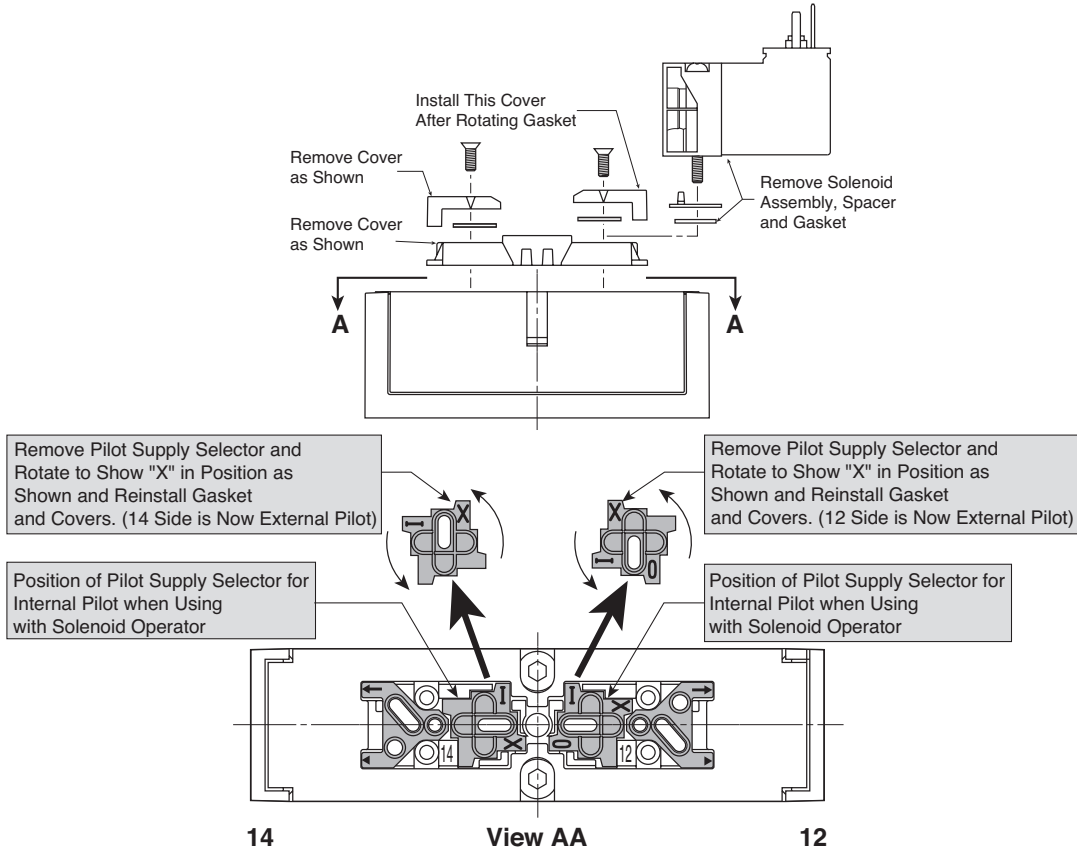

Changing from External Pilot Supply, Vented Pilot Exhaust to Internal Pilot Supply, Captured Pilot Exhaust

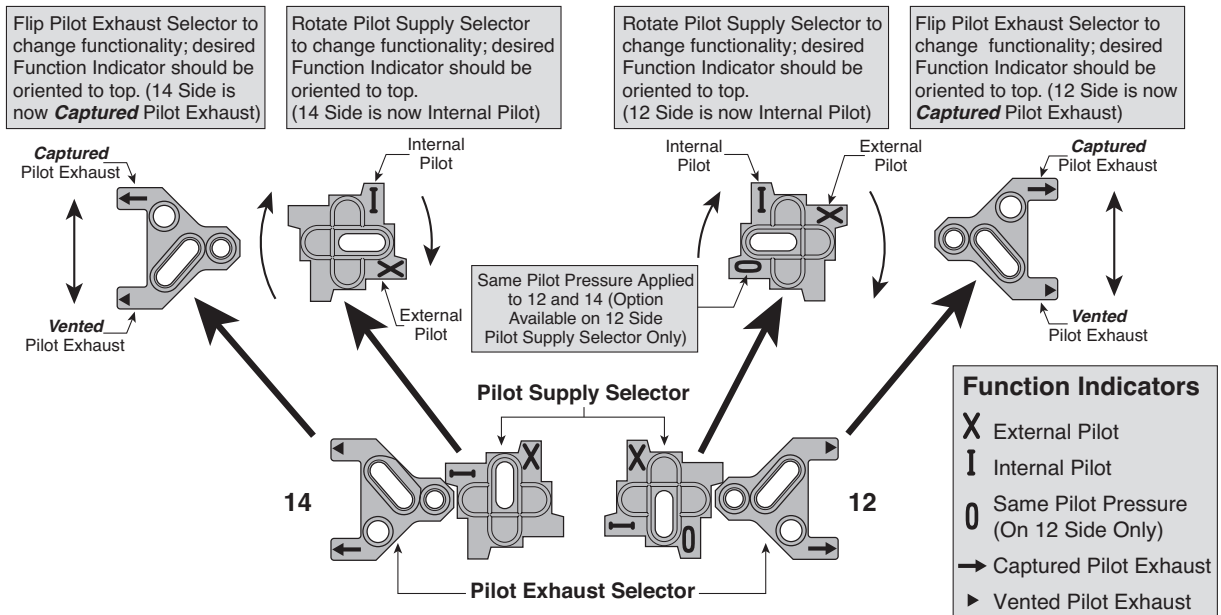

D
 Subbase & Manual Valves
 H Series Micro
 Modulflex Series
 H Series ISO
 Network Connectivity
 DX ISOMAX Series
 Valvair II Series

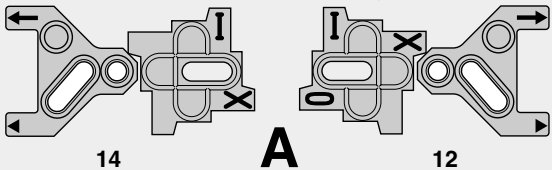
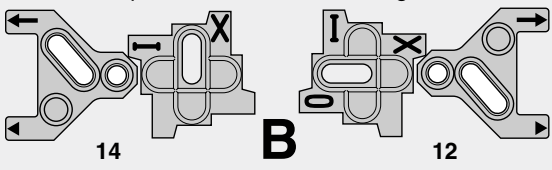
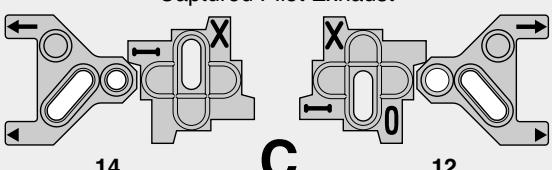
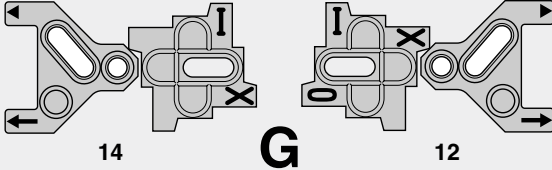
Internal Pilot Supply; Captured Pilot Exhaust through 12 				
External or Single Remote Pilot Supply on 14; Internal Pilot Supply on 12; Captured Pilot Exhaust through 12 				
External, Double Remote Pilot Supply on 14 & 12; Captured Pilot Exhaust 				
Internal Pilot Supply; Vented Pilot Exhaust 				
Base Pilot Port Used	None	14	14 and 12	None
Pilot Air Supply	Internal Pilot Supply	14 External Pilot 12 Internal Pilot	External, Double Remote Pilot for 14 and 12	Internal Pilot Supply
Pilot Exhaust	Captured	Captured	Captured	Vented
5/2 Double Solenoid	606 A	—	406 C	604 G
5/2 Single Solenoid	621	421	C	620
5/2 Double Solenoid, on Sandwich Regulator	—	—	—	—
Spring Return	A	B	—	G
5/2 Single Solenoid, Differential Return	651 A	451 B	C	65 G
5/3 Pressure Center Exhaust	611 A	—	411 C	627 G
5/3 Pressure All Ports Blocked	616 A	—	416 C	625 G
Part Numbers Available From Factory				

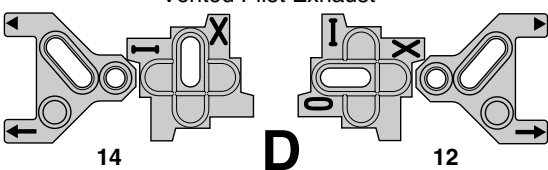
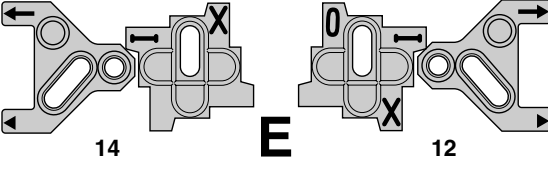
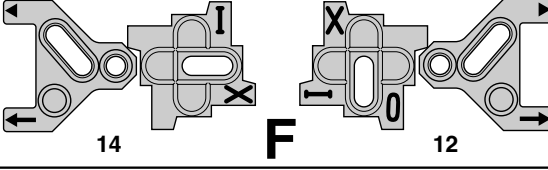
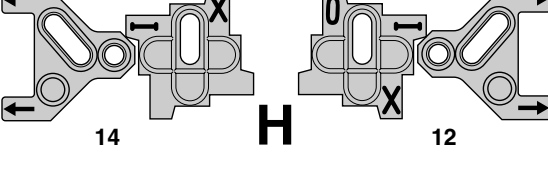
External Pilot Supply on 14; Internal Pilot Supply on 12; Vented Pilot Exhaust 	
External Pilot Supply 14 Common to 12; Captured Pilot Exhaust through 12 	
Internal Pilot Supply on 14; External Pilot Supply on 12; Vented Pilot Exhaust 	
External Pilot Supply 14 Common to 12; Vented Pilot Exhaust 	

Base Pilot Port Used	14	14	12
Pilot Air Supply	14 External Pilot 12 Internal Pilot	One Common External Pilot Pressure for 14 and 12	14 Internal Pilot 12 External Pilot
Pilot Exhaust	Vented	Captured	Vented
5/2 Double Solenoid	D	E	F
5/2 Single Solenoid	D	E	F
5/2 Double Solenoid, on Sandwich Regulator	External Pilot Supply 14 Common to 12 Vented Pilot Exhaust – See Diagram 'H'		
Spring Return	—	—	—
5/2 Single Solenoid, Differential Return	D	E	F
5/3 Pressure Center Exhaust	D	E	F
5/3 Pressure All Ports Blocked	D	E	F
See Gasket Configurations Above for These Special Adaptations			

Insert a muffler or vent in the EXH Port of the PEJ02 & PEJ01 Manifold End Plates or #12 of PL02 & PL01 Subbases when using solenoids with a **Captured** Exhaust.

A plug may be inserted in the EXH Port of the PEJ02 & PEJ01 Manifold End Plates #14 or #12 of PL02 & PL01 Subbases when using a **Vented** Exhaust.



For inventory, lead times, and kit lookup, visit www.pdnplu.com

DX01 Manifold Assembly

Ports

- 1 Pressure
- 2 #2 Cylinder Port, 1 to 2 Flow Path
- 3 Cylinder Exhaust Port, 2 to 3 Flow Path
- 4 #4 Cylinder Port, 1 to 4 Flow Path
- 5 Cylinder Exhaust Port, 4 to 5 Flow Path
- 14 #14 Pilot Port
- 12 #12 Pilot Port

Torque Specifications: 25 to 35 in-lbs (2.82 to 3.95 Nm)

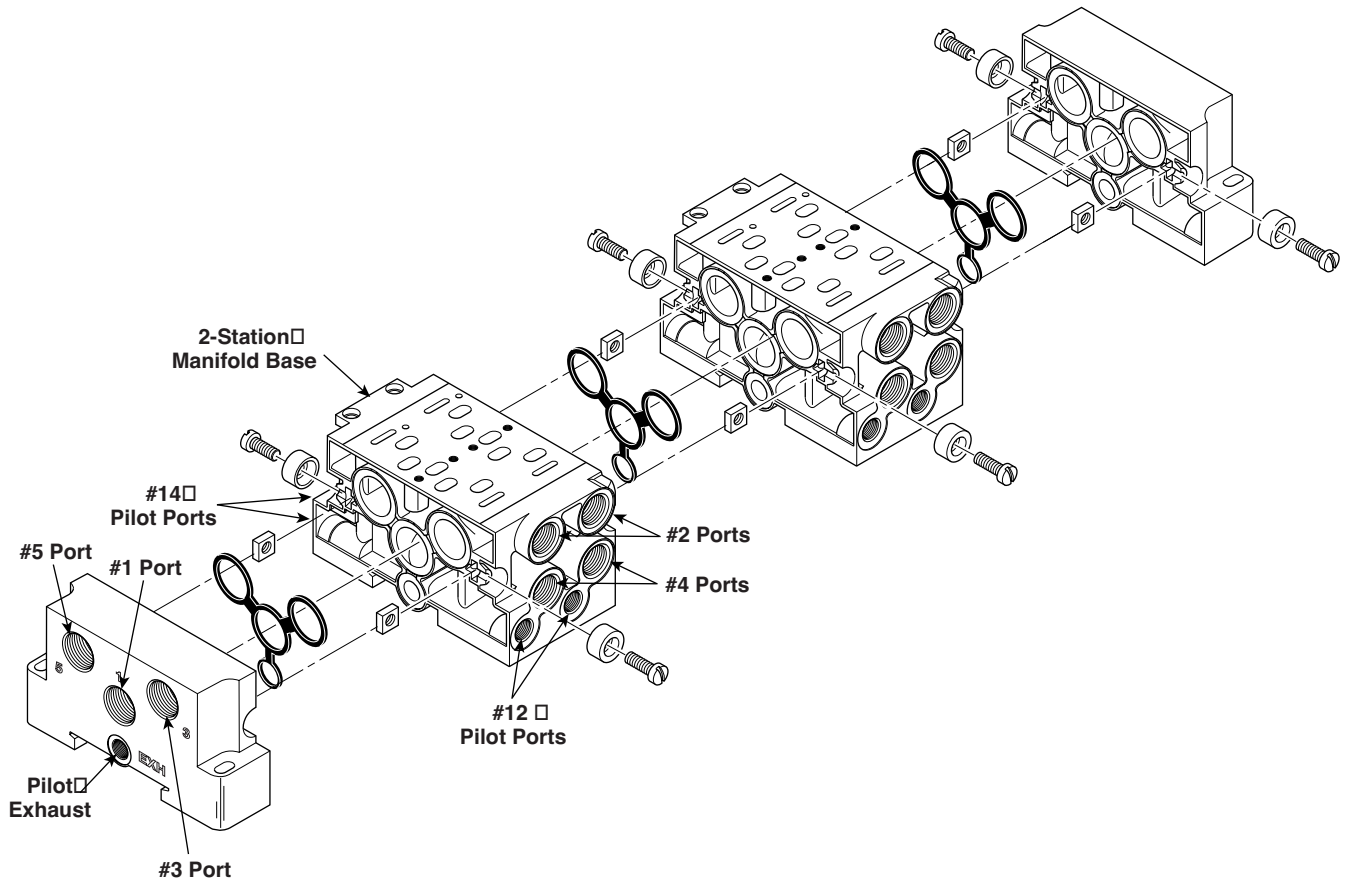

DX01 Shown

D
Subbase & Manual Valves
H Series Micro
Modulflex Series
H Series ISO
Network Connectivity
DX ISOMAX Series
Valvair II Series



For inventory, lead times, and kit lookup, visit www.pdnplu.com

D255

Parker Hannifin Corporation
 Pneumatic Division
 Richland, Michigan
www.parker.com/pneumatics

DX 15407-1 Size 01, Manifold Conversion Instructions

Captured Pilot Exhaust

PJL01, Size 01

A Built-in 2-Position Selector converts the External Pilot Channel (12) into a Common Solenoid Pilot Exhaust Channel.

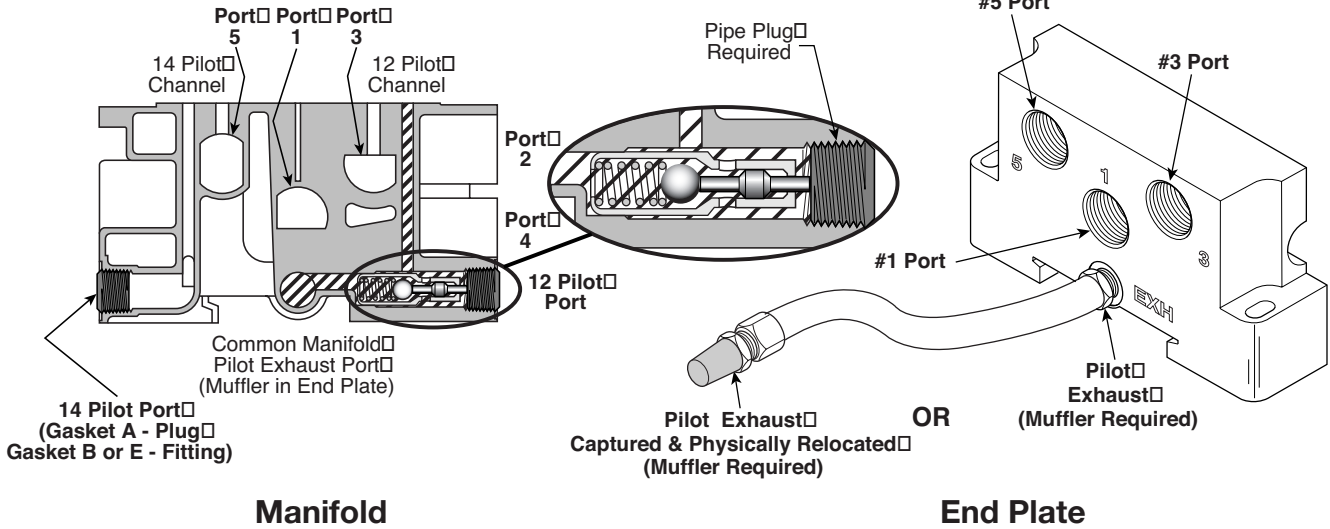

Built-in Selector

When using A, B or E **Captured** Selector Gasket Positions, the 12 Pilot Port is plugged. The 14 Pilot Port has a plug when using Gasket A or a fitting when using Gasket B or E. When in place, the Plug in the 12 Pilot Port depresses the Selector to connect the Valve Solenoid Pilot Exhaust to a Common Manifold Exhaust Port. The Plug must make contact with the Pin of the Internal Check Valve.

Insert a Muffler in the EXH Port of the End Plate.

Captured Selector Gasket Positions

When using A, B or E Selector Gasket Positions as shown in the schematic at right.

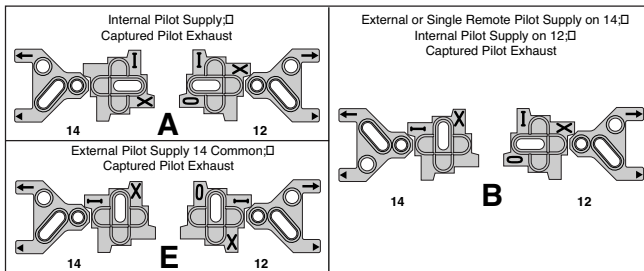

Insert a muffler or vent in the EXH Port of the PEJ02 & PEJ01 Manifold End Plates or #12 of PL02 & PL01 Subbases when using solenoids with **Captured** Pilot Exhaust.

DX01 Manifold Assembly Schematic for Captured Selector Gasket Positions A, B and E

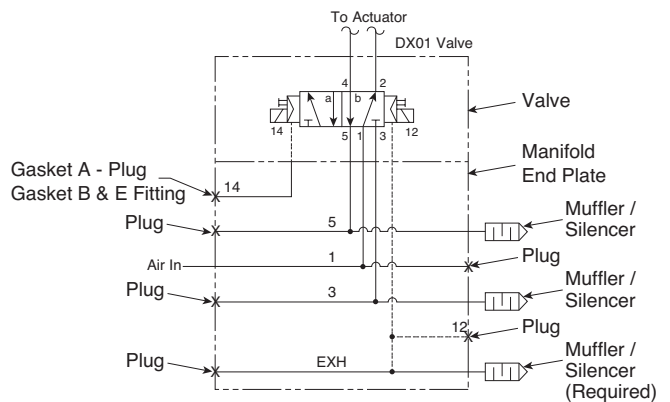

D

Subbase & Manual Valves

H Series Micro

Modulflex Series

H Series ISO

Network Connectivity

DX ISOMAX Series

Valvair-II Series



For inventory, lead times, and kit lookup, visit www.pdnplu.com

D256

Parker Hannifin Corporation
 Pneumatic Division
 Richland, Michigan
www.parker.com/pneumatics

DX 15407-1 Size 01, Manifold Conversion Instructions

**Vented
 Pilot Exhaust**

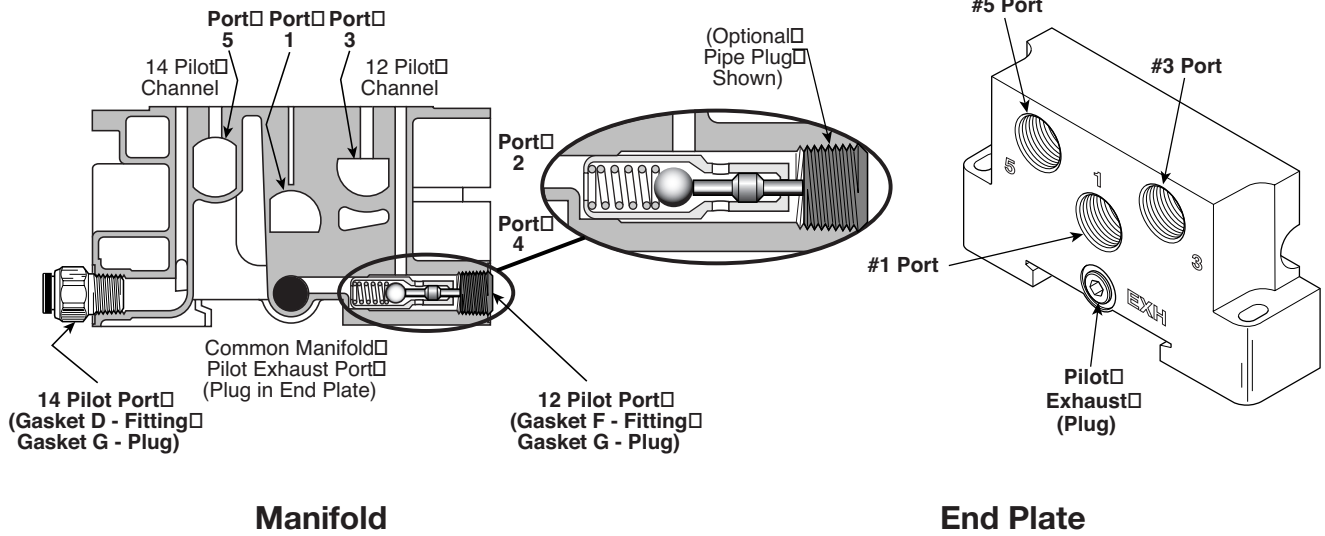

Built-in Selector

When using D or G **Vented** Selector Gasket Positions, the 12 Pilot Port may be plugged (Optional). The 14 Pilot Port has a plug when using Gasket G or a fitting when using Gasket D or F. The valve solenoid pilot exhaust vents out the pilot adapter on the G Gasket Selection.

Vented Selector Gasket Positions

When using D, F or G Selector Gasket Positions, pilot exhaust air is vented out the valve.

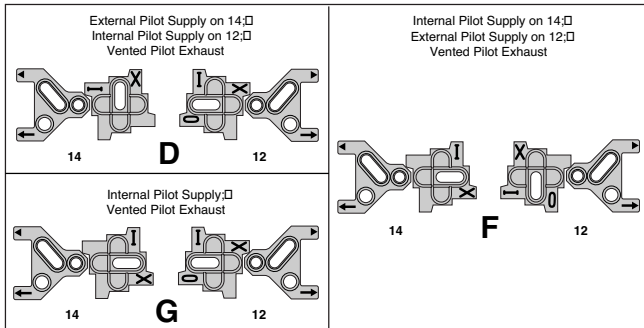

A plug may be inserted in the EXH Port of the PEJ02 & PEJ01 Manifold End Plates, #12 of PL02 & PL01 Subbases.

DX01 Manifold Assembly Schematic for Vented Selector Gasket Positions D or G

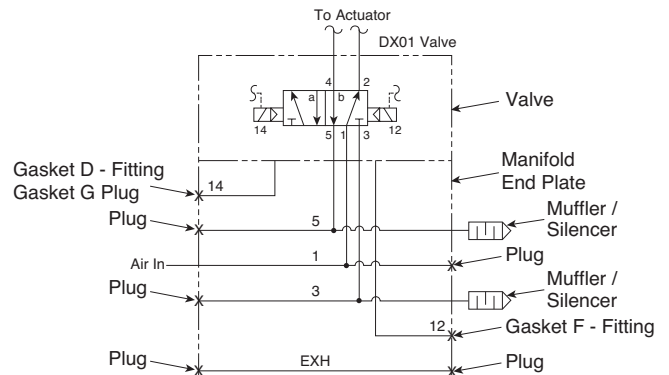

DX 15407-1 Size 01, Manifold Conversion Instructions

External Double Remote Pilot

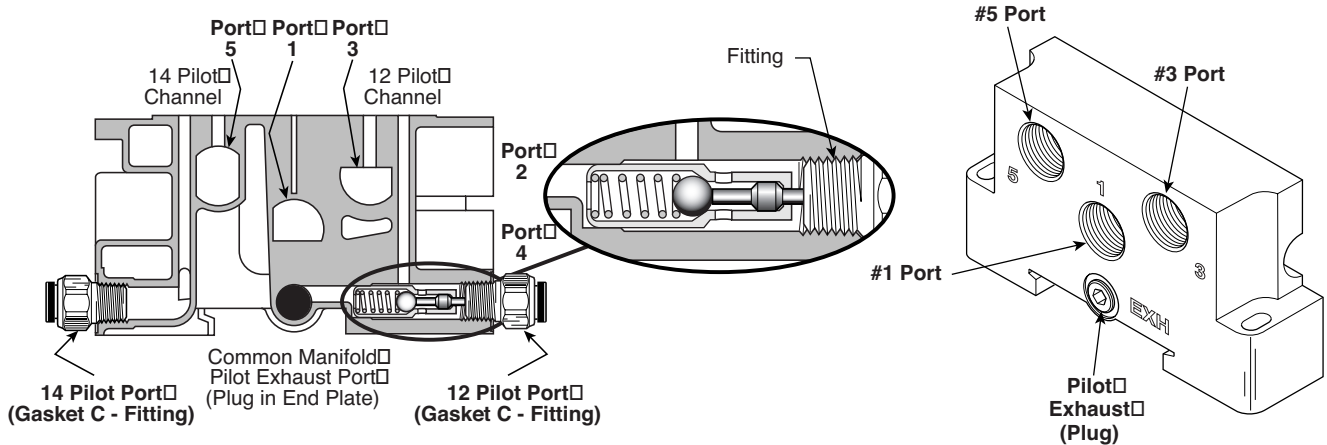

Built-in Selector

When using C **External Double Remote Pilot** Selector Gasket Position, a fitting is used in Pilot Port 14 & 12. Free flow between Port 14 & 12 and the valve allows Remote Pilot Pressure and an exhaust path for the captured pilot exhaust.

External Double Remote Pilot Selector Gasket Position

When using C Selector Gasket Position.

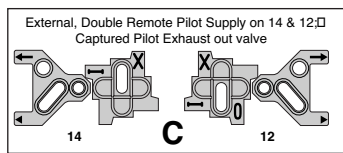

DX01 Manifold Assembly Schematic for External Double Remote Pilot Selector Gasket Position C

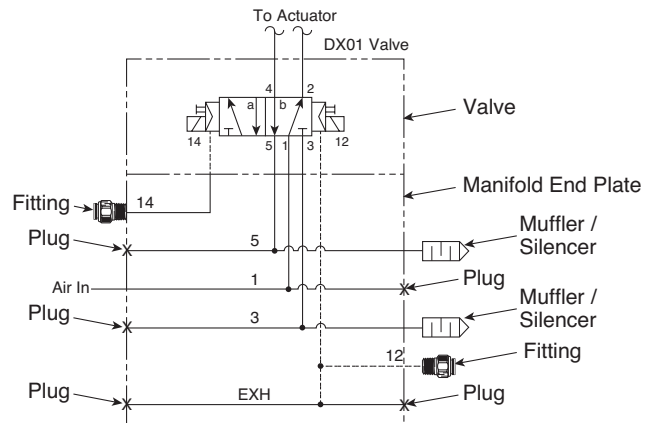

D

Subbase & Manual Valves

H Series Micro

Modulflex Series

H Series ISO

Network Connectivity

DX ISOMAX Series

Valvair II Series



For inventory, lead times, and kit lookup, visit www.pdnplu.com

D258

Parker Hannifin Corporation
 Pneumatic Division
 Richland, Michigan
www.parker.com/pneumatics

DX02 Manifold Assembly

Ports

- 1.....Pressure
- 2.....#2 Cylinder Port, 1 to 2 Flow Path
- 3.....Cylinder Exhaust Port, 2 to 3 Flow Path
- 4.....#4 Cylinder Port, 1 to 4 Flow Path
- 5.....Cylinder Exhaust Port, 4 to 5 Flow Path
- 14.....#14 Pilot Port
- 12.....#12 Pilot Port

Torque Specifications: 25 to 35 in-lbs (2.82 to 3.95 Nm)

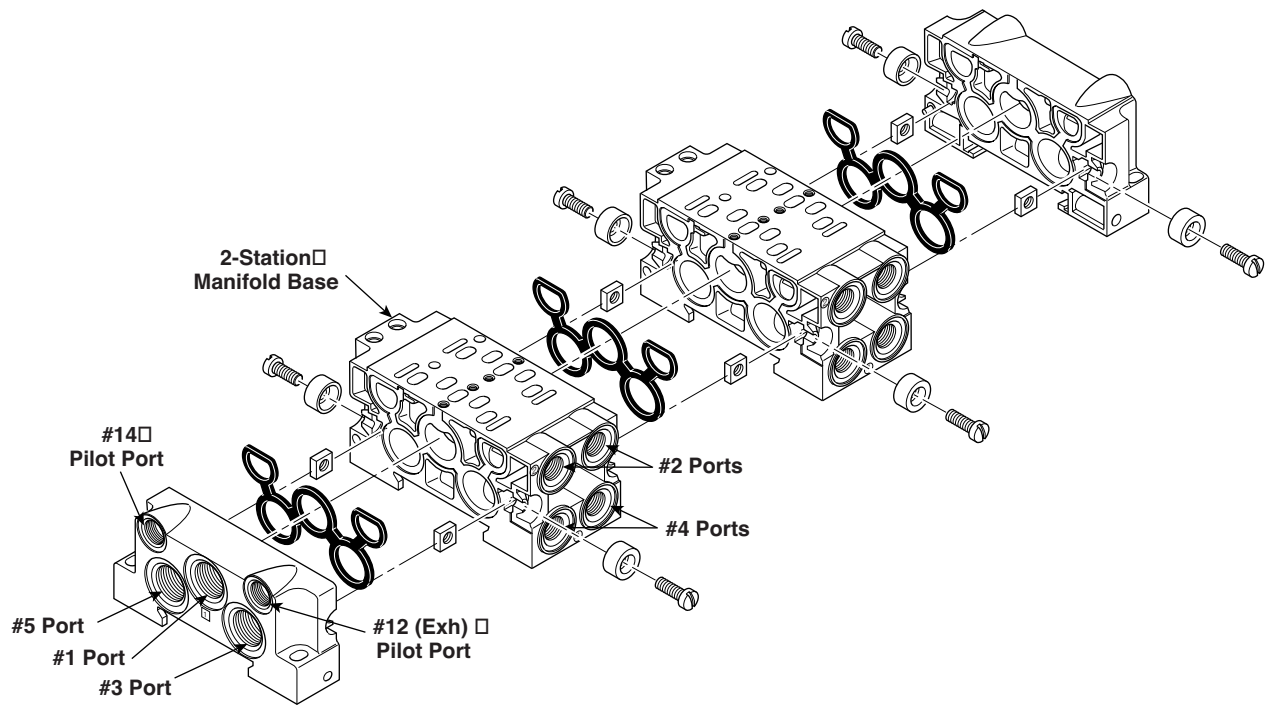

DX02 Shown



For inventory, lead times, and kit lookup, visit www.pdnplu.com

D259

Parker Hannifin Corporation
 Pneumatic Division
 Richland, Michigan
www.parker.com/pneumatics

D

Subbase & Manual Valves

H Series Micro

Moduflex Series

H Series ISO

Network Connectivity

DX ISOMAX Series

Valvair II Series

DX 15407-1 Size 02, Manifold Conversion Instructions

***Captured
Pilot Exhaust***

PJLP02, Size 02*

As shown in the illustrations below, the EXH (12) & 14 Pilot Ports are exhausted internally in the valve body into a single chamber labeled EXH on the end plate. When using A, B, D or E Selector Gasket Positions, the EXH (12) Pilot Port is vented with a muffler or micron screen. The 14 Pilot Port is plugged.

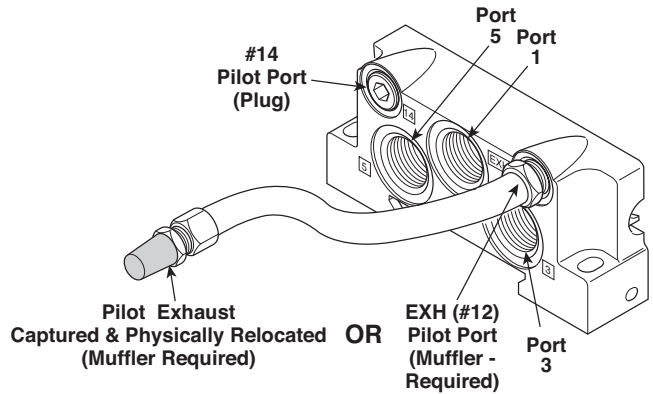
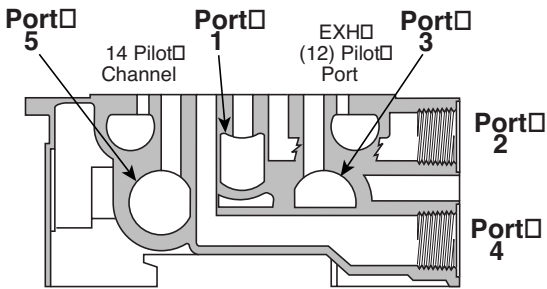

D
Subbase & Manual Valves
H Series Micro
Modulflex Series
H Series ISO
Network Connectivity
DX ISOMAX Series
Valvair II Series

Captured Selector Gasket Positions

When using A, B, D or E, Selector Gasket Positions, the ports must be either plugged or vented with a muffler or micron screen as shown in the schematic at right.

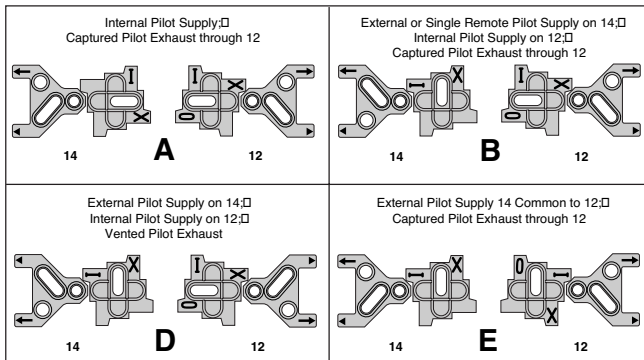

* PJLP02 Manifolds can be used for External Pilot, **NOT** Remote Pilot

DX02 Manifold Assembly Schematic for Captured Selector Gasket Positions A, B, D and E

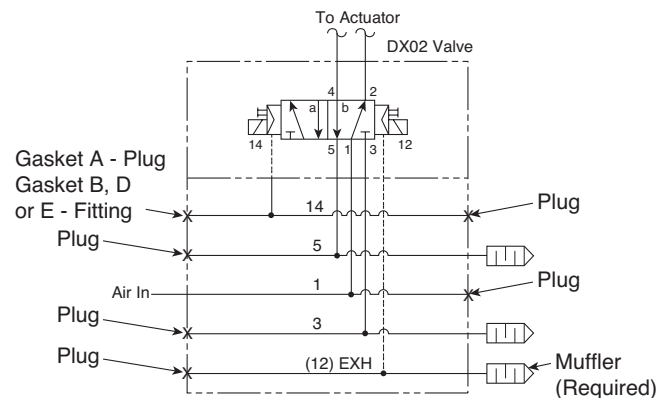

For inventory, lead times, and kit lookup, visit www.pdnplu.com

D260

Parker Hannifin Corporation
Pneumatic Division
Richland, Michigan
www.parker.com/pneumatics

DX 15407-1 Size 02, Manifold Conversion Instructions

**Vented
 Pilot Exhaust**

PJLP02, Size 02

When using F or G Selector Gasket Positions, the EXH (12) Pilot Port and the 14 Pilot Port are plugged and the Pilot Exhaust is vented through the Pilot Adapter.

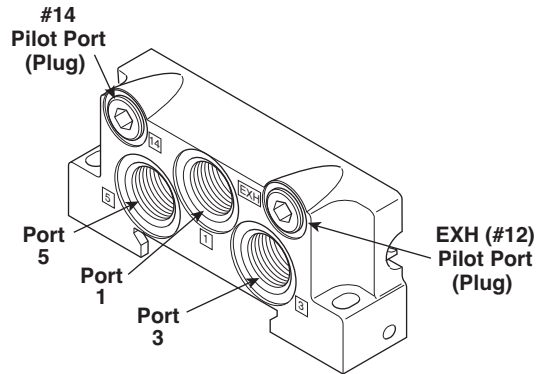
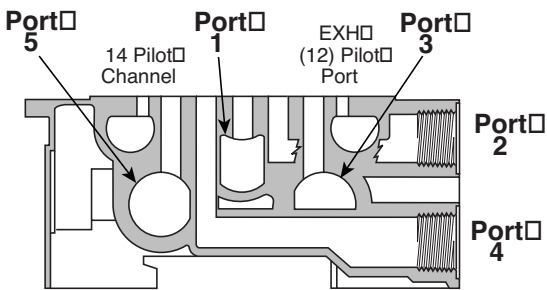

Vented Selector Gasket Positions

When using F or G, Selector Gasket Positions, the ports must be either plugged or vented with a muffler or micron screen as shown in the schematic at right.

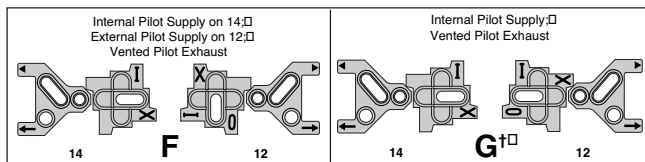

† A plug may be inserted in the EXH Port of the PEJ02 & PEJ01 Manifold End Plates or #12 of PL02 & PL01 Subbases.

**DX02 Manifold Assembly
 Schematic for Vented Selector Gasket
 Positions F and G**

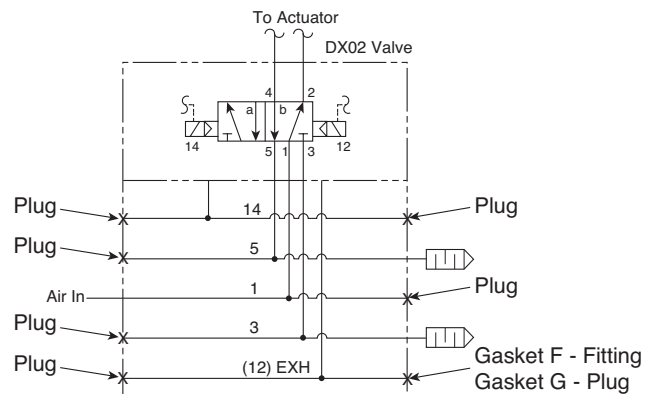

Subbase Assembly

Ports

- 1..... Pressure
- 2..... #2 Cylinder Port. 1 to 2 Flow Path.
- 3..... Cylinder Exhaust Port. 2 to 3 Flow Path.
- 4..... #4 Cylinder Port. 1 to 4 Flow Path.
- 5..... #4 Cylinder Port. 1 to 5 Flow Path.
- 14..... #14 Pilot Port
- 12..... #12 Pilot Port

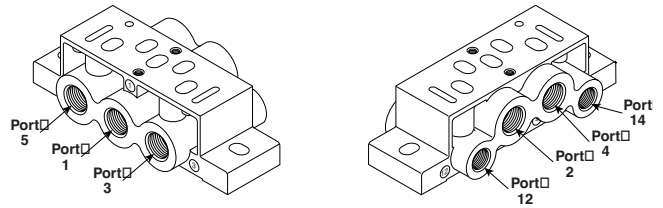

Captured Selector Gasket Positions

When using A, B, C, D or E, Selector Gasket Positions, the ports must be either plugged or vented with a muffler or micron screen as shown in the schematic at right.

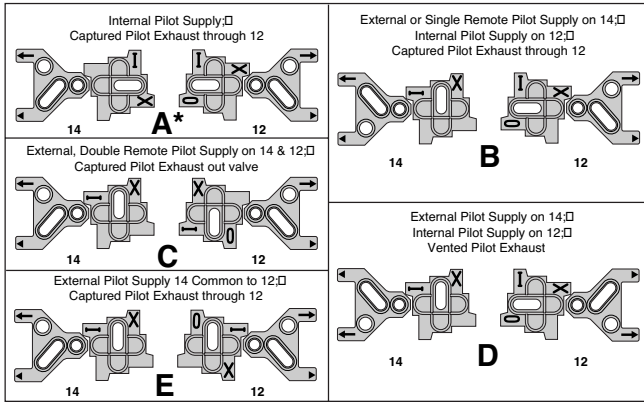

DX02 & DX01 Subbase Assembly Schematic for Captured Selector Gasket Positions A, B, C, D and E

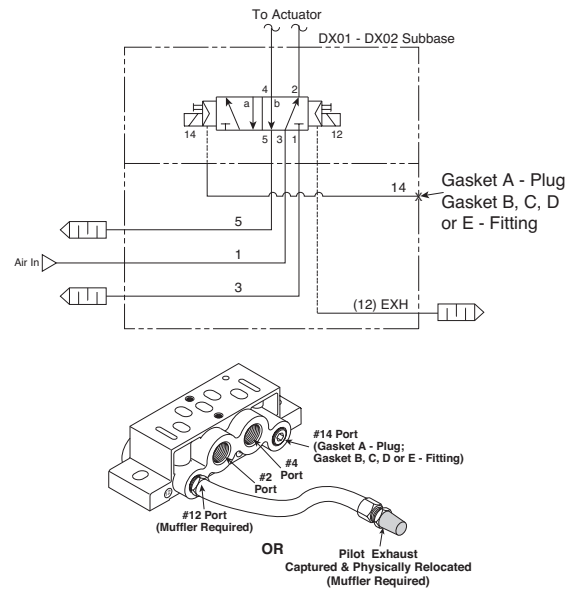

Vented Selector Gasket Positions

When using F or G, Selector Gasket Positions, the ports must be either plugged or vented with a muffler or micron screen as shown in the schematic at right.

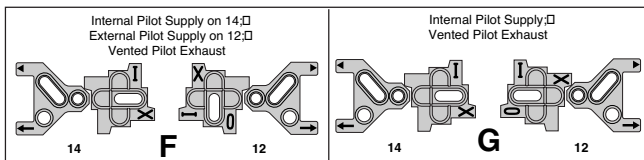

DX02 & DX01 Subbase Assembly Schematic for Vented Selector Gasket Positions F and G

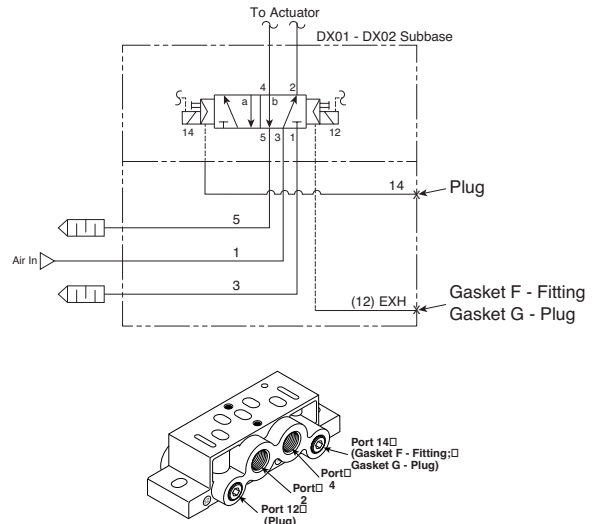

D
 Subbase & Manual Valves
 H Series Micro
 Modflex Series
 H Series ISO
 Network Connectivity
 DX ISOMAX Series
 Valvair II Series



For inventory, lead times, and kit lookup, visit www.pdnplu.com

DX1 / DX2 / DX3

Internal / External Pilot Conversion Instructions

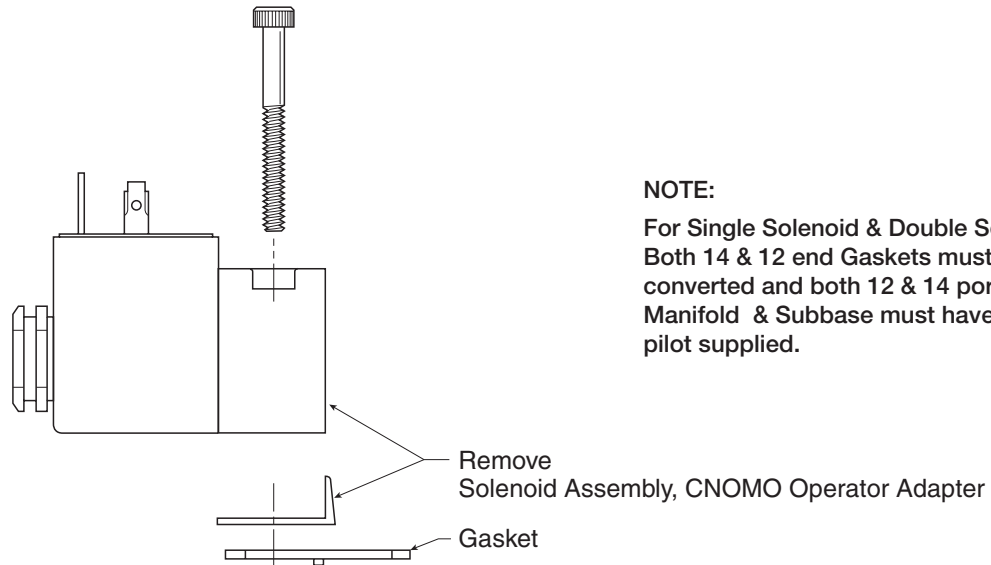

NOTE:

For Single Solenoid & Double Solenoid – Both 14 & 12 end Gaskets must be converted and both 12 & 14 ports in the Manifold & Subbase must have external pilot supplied.

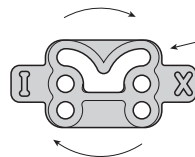
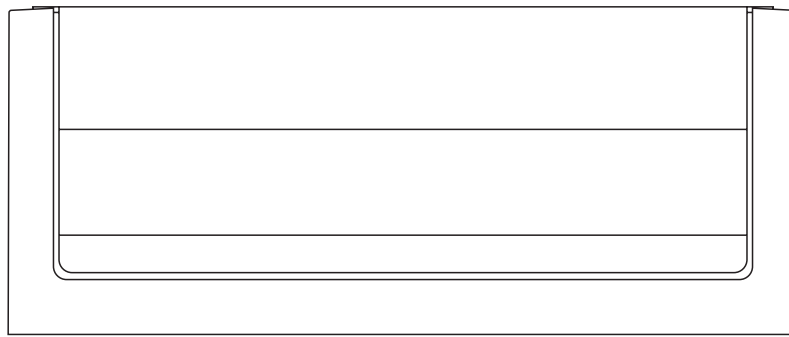

Remove Gasket and Rotate to Show "I" in Position as Shown and Reinstall Gasket and Covers. (Valve is Now External Pilot)

Position of Gasket for Internal Pilot when Using with Solenoid Operator

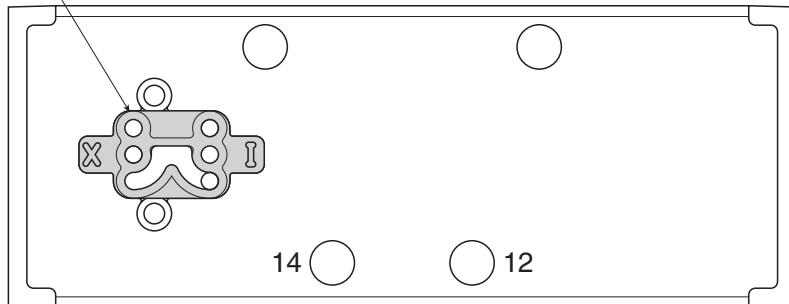

D

Subbase & Manual Valves

H Series Micro

Moduflex Series

H Series ISO

Network Connectivity

DX ISOMAX Series

Valvair II Series

DX1, DX2, DX3 VDMA & 5599-1 Side Ported Subbase

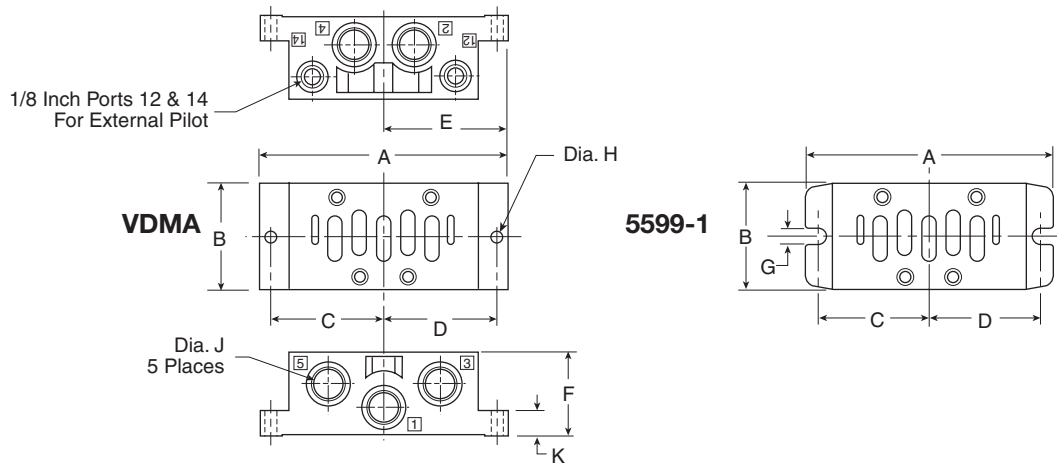

Series	Part Number	J	A	B	C	D	E	F	G	H	K
VDMA	DX1 P2N-VS512SD	BSPP G1/4	4.33 (110)	1.89 (48)	1.93 (49)	1.93 (49)	2.17 (55)	1.26 (32)	—	0.22 (5.5)	0.39 (9.9)
	DX2 P2N-WS513SD	BSPP G3/8	4.88 (124)	2.21 (56)	2.21 (56)	2.21 (56)	2.44 (62)	1.57 (40)	—	0.26 (6.6)	0.51 (13)
	DX3 P2N-YS514SD	BSPP G1/2	5.87 (149)	2.80 (71)	2.68 (68)	2.68 (68)	2.93 (74.5)	2.05 (52)	—	0.26 (6.6)	0.71 (18)
5599-1	DX1 PL1-1/4-70	BSPP G1/4	4.33 (110)	1.81 (46)	1.93 (49)	1.93 (49)	2.17 (55)	1.14 (29)	0.22 (5.5)	—	0.24 (6)
	DX1 PL1-1/4-80	NPT 1/4									
	DX2 PL2-3/8-70	BSPP G3/8	4.88 (124)	2.21 (56)	2.17 (55)	2.17 (55)	2.44 (62)	1.46 (37)	0.22 (5.5)	—	0.24 (6)
	DX2 PL2-3/8-80	NPT 3/8									
	DX3 PL3-1/2-70	BSPP G1/2	5.87 (149)	2.80 (71)	2.68 (68)	2.68 (68)	2.93 (74.5)	2.36 (60)	0.26 (6.6)	—	0.71 (18)
	DX3 PL3-1/2-80	NPT 1/2									

Inches (mm)

DX1, DX2 5599-1 Bottom Ported Subbase

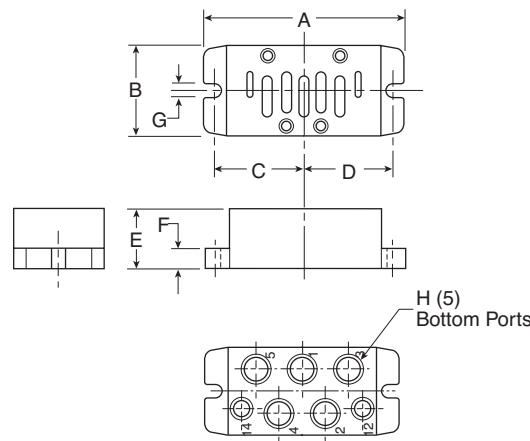

Bottom Ported Subbase

Series	Part Number	H	A	B	C	D	E	F	G
DX1	PD1-1/4-70	BSPP G1/4	4.33 (110)	1.81 (46)	1.93 (49)	1.93 (49)	1.14 (29)	0.24 (6)	0.22 (5.5)
	PD1-1/4-80	NPT 1/4							
DX2	PD2-3/8-70	BSPP G13/8	4.88 (124)	2.20 (56)	2.17 (55)	2.17 (55)	1.46 (37)	0.24 (6)	0.22 (5.5)
	PD2-3/8-80	NPT 3/8							

Inches (mm)

D Subbase & Manual Valves
 H Series Micro
 Modulflex Series
 H Series ISO
 Network Connectivity
 DX ISOMAX Series
 Valvair II Series



For inventory, lead times, and kit lookup, visit www.pdnplu.com

D264

Parker Hannifin Corporation
 Pneumatic Division
 Richland, Michigan
www.parker.com/pneumatics

DX01 & DX02 Valve

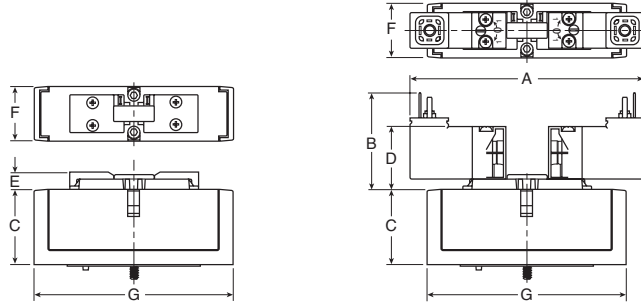

Series	A	B	C	D	E	F	G
DX02	4.06 (103)	1.61 (41)	1.41 (36)	1.06 (27)	.31 (8)	.71 (18)	3.15 (80)
DX01	4.06 (103)	1.61 (41)	1.41 (36)	1.06 (27)	.31 (8)	1.02 (26)	3.94 (100)

Inches (mm)

DX01 & DX02 Individual Subbase

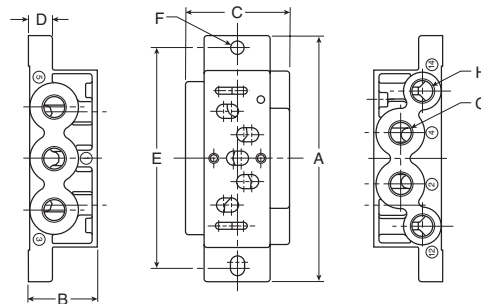

Series	Part Number	A	B	C	D	E	F	G	H
DX02	PL02	3.15 (80)	.87 (22)	1.06 (27)	.31 (8)	2.76 (70)	.216 Dia. (Ø 5.5)	1/8	M5
DX01	PL01	3.94 (100)	1.10 (28)	1.65 (42)	.39 (10)	3.54 (90)	.216 Dia. (Ø 5.5)	1/4	1/8

Inches (mm)

DX01 & DX02 2-Station Manifold Base

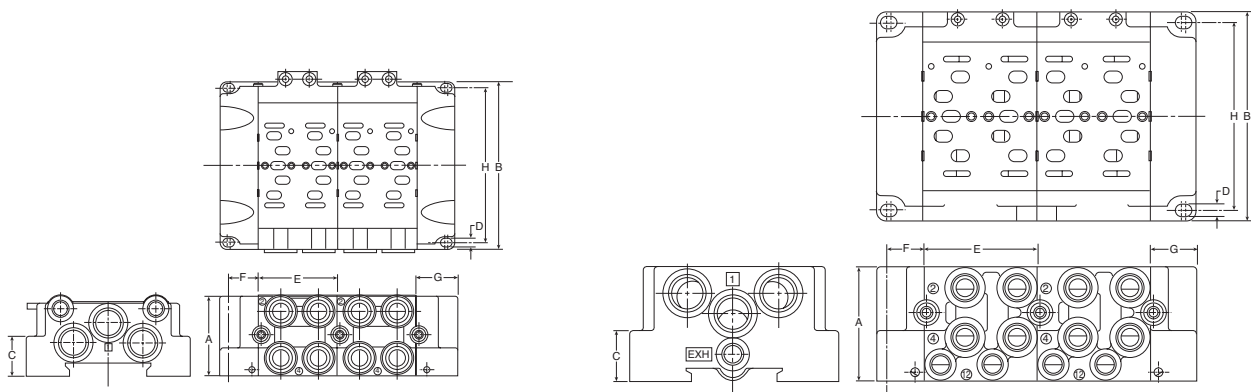

Series	Part Number	A	B	C	D	E	F	G	H
DX02	PJLP02 / PEJ02	1.52 (38.5)	3.15 (80)	.47 (12)	.165 Dia. (Ø 4.2)	1.50 (38)	.55 (14)	.71 (18)	2.83 (72)
DX01	PJL01 / PJLP01 / PEJ01	2.17 (55)	3.94 (100)	.94 (24)	.216 Dia. (Ø 5.5)	2.13 (54)	.67 (17)	.87 (22)	3.54 (90)

Inches (mm)



For inventory, lead times, and kit lookup, visit www.pdnplu.com

D265

Parker Hannifin Corporation
 Pneumatic Division
 Richland, Michigan
www.parker.com/pneumatics

D

Subbase & Manual Valves

H Series Micro

Moduflex Series

H Series ISO

Network Connectivity

DX ISOMAX Series

Valvair II Series

DX01 15407-1, PS5511 Subbases

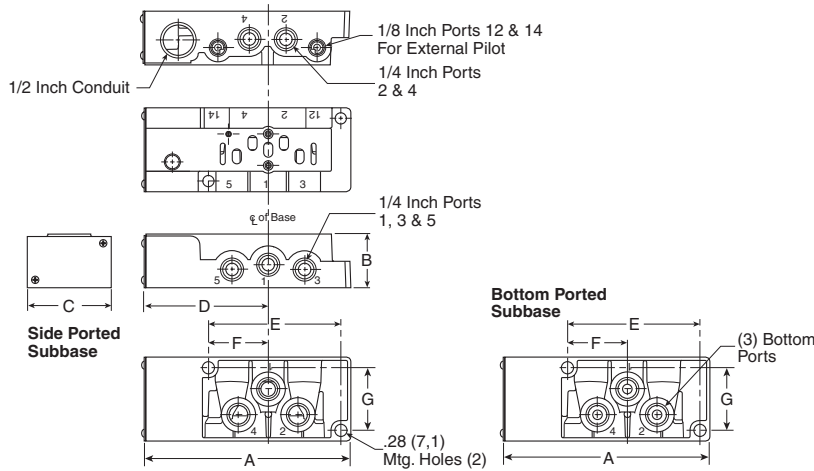

PS5511 Subbase

A	B	C	D
4.88 (124)	1.28 (32.5)	2.00 (50.8)	2.91 (74)
E	F	G	
1.43 (36.2)	3.16 (80.2)	1.49 (37.9)	

Inches (mm)

DX02 & DX01 15407-1, PS5611 & PS5511 Manifolds

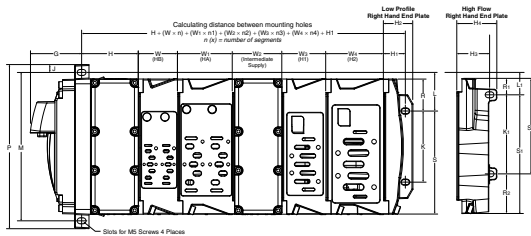

A	B	C1	C2	C3	C4	C5
6.81 (172.95)	6.16 (156.5)	1.65 (41.79)	2.28 (57.79)	2.04 (51.79)	1.84 (46.79)	2.39 (60.79)
D1	D2	D3	D4	E	F	G
1.60 (40.71)	1.60 (40.71)	0.96 (24.3)	1.92 (48.8)	0.32 (8.0)	3.09 (78.58)	4.39 (111.58)
J1	J2	J3	K	L	M	N
0.44 (11.2)	1.92 (48.7)	1.31 (33.3)	0.30 (7.5)	4.14 (105.08)	2.40 (61.08)	1.92 (48.7)
O	P	Q	R			
4.21 (107)	4.45 (113)	6.09 (154.77)	6.51 (165.32)			

Inches (mm)

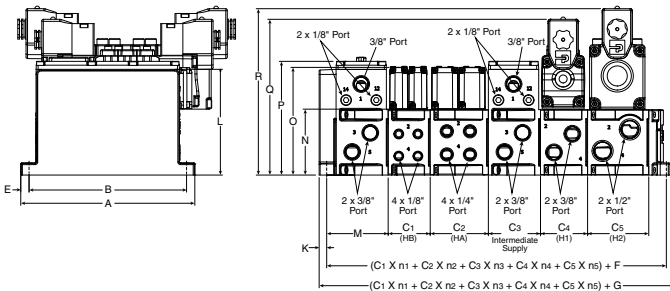

Series	Part Number	A	B	B1	C	D	E
DX02	PS5637	10.28 (261)	6.14 (156)	1.02 (26)	5.13 (130)	2.60 (66)	1.18 (30)
DX01	PS5537	10.00 (254)	6.42 (163)	1.42 (36)	5.00 (127)	2.72 (69)	1.18 (30)

Inches (mm)

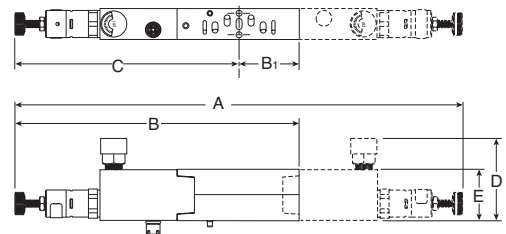

D
 Subbase & Manual Valves
 H Series Micro
 Modulflex Series
 H Series ISO
 Network Connectivity
 DX ISOMAX Series
 Valvair II Series



For inventory, lead times, and kit lookup, visit www.pdnplu.com

D266

Parker Hannifin Corporation
 Pneumatic Division
 Richland, Michigan
www.parker.com/pneumatics

DX1, DX2 & DX3 Air Operated Valve

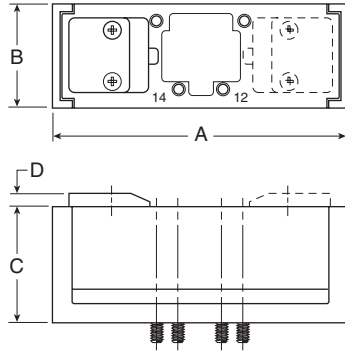

Series	A	B	C	D
DX1	4.72 (120)	1.65 (42)	1.85 (47)	.20 (5)
DX2	5.51 (140)	2.13 (54)	2.30 (58.5)	.20 (5)
DX3	6.69 (170)	2.68 (68)	2.80 (71)	.20 (5)

Inches (mm)

DX1, DX2 & DX3 Solenoid Operated Valve

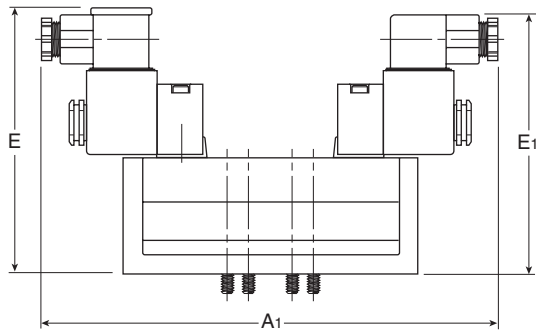

Series	A1	E	E1	E2
DX1	7.97 (202.5)	4.43 (112.5)	4.69 (119)	4.53 (115)
DX2	8.58 (218)	4.86 (123.5)	5.12 (130)	4.98 (126.5)
DX3	9.27 (235.5)	5.35 (136)	5.61 (142.5)	5.47 (139)

Inches (mm)



DX3 Subbase

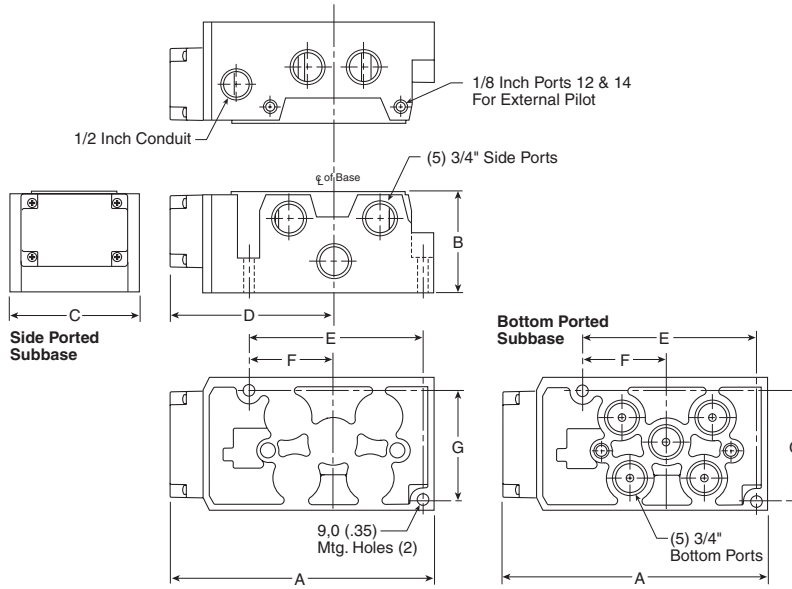

PS4211 Subbase

A	B	C	D
7.90 (201)	2.96 (75)	3.90 (990)	4.92 (125)
E	F	G	
5.14 (131)	2.50 (64)	3.24 (82)	

Inches (mm)

D

Subbase & Manual
 Valves

H Series
 Micro

Modulflex
 Series

H Series
 ISO

Network
 Connectivity

DX ISOMAX
 Series

Valvair II
 Series



For inventory, lead times, and kit lookup, visit www.pdnplu.com

D268

Parker Hannifin Corporation
 Pneumatic Division
 Richland, Michigan
www.parker.com/pneumatics

DX1 Manifold

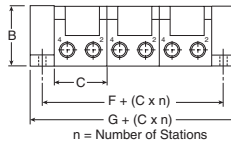
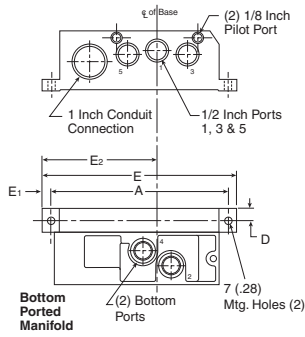

PS4011 Manifold

A	B	C	D	E
6.50 (165)	2.20 (56)	1.93 (49)	.44 (11)	7.15 (182)
E1	E2	F	G	
.33 (8)	4.25 (108)	.87 (22)	1.80 (46)	

Inches (mm)

DX2 Manifold

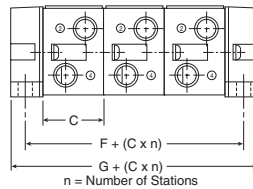
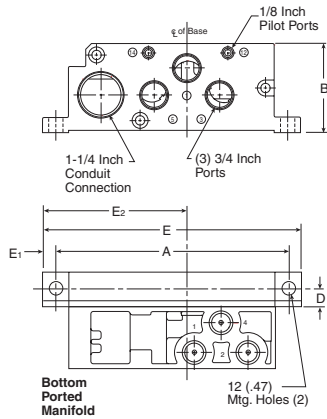

PS4111 Manifold

A	B	C	D	E
8.46 (215)	3.35 (85)	2.20 (56)	.59 (15)	9.41 (239)
E1	E2	F	G	
.47 (12)	5.28 (134)	1.18 (30)	2.36 (60)	

Inches (mm)

DX3 Manifold

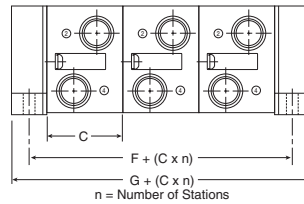
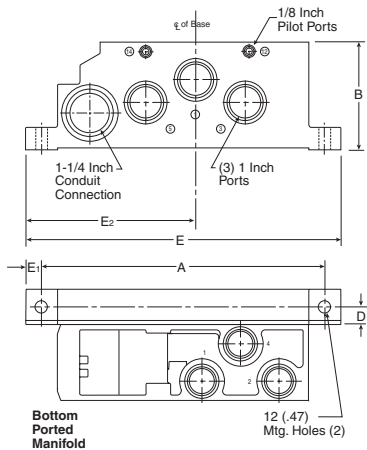

PS4211 Manifold

A	B	C	D	E
10.41 (265)	4.13 (105)	2.80 (71)	.65 (175)	11.61 (295)
E1	E2	F	G	
.59 (15)	6.26 (159)	1.30 (33)	2.60 (63)	

Inches (mm)



For inventory, lead times, and kit lookup, visit www.pdnplu.com

D269

Parker Hannifin Corporation
 Pneumatic Division
 Richland, Michigan
www.parker.com/pneumatics

D

Subbase & Manual Valves

H Series Micro

Moduflex Series

H Series ISO

Network Connectivity

DX ISOMAX Series

Valvair II Series

DX1, DX2, DX3 5599-1 VDMA

Form C Manifold &
 Form D End Plates

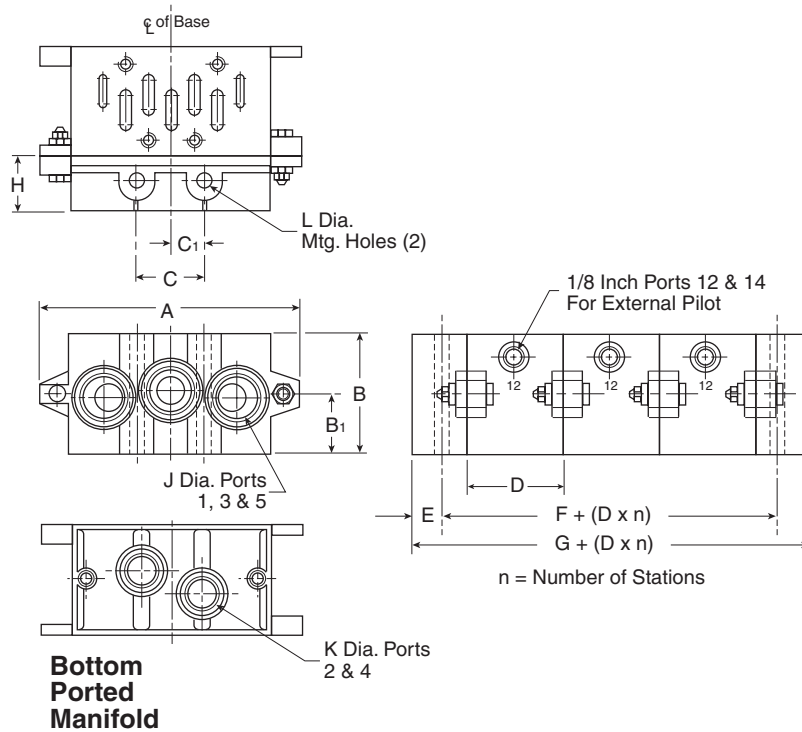

VDMA Form C Manifold

Series	Part Number	A	B	B1	D	E	F	G	J	K
DX1	P2N-VM512MB	4.33 (110)	1.81 (46)	0.94 (24)	1.69 (55)	0.43 (22)	0.87 (22)	1.73 (44)	BSPP G3/8	BSPP G1/4
DX2	P2N-WM513MB	5.31 (135)	1.85 (47)	0.94 (24)	2.20 (56)	0.51 (13)	1.02 (26)	2.05 (52)	BSPP G1/2	BSPP G3/8
DX3	P2N-YM514MB	7.48 (190)	2.20 (56)	1.34 (34)	2.80 (71)	0.59 (15)	1.18 (30)	2.36 (60)	BSPP G1/2	BSPP G1/2

VDMA Form D End Plate

Series	Part Number	A	B	B1	C	C1	H	L
DX1	P2N-VM513ES	4.33 (110)	1.81 (46)	0.94 (24)	1.10 (28)	0.55 (14)	0.87 (22)	0.28 (7)
DX2	P2N-WM514ES	5.31 (135)	1.85 (47)	0.94 (24)	1.38 (35)	0.69 (18)	1.02 (26)	0.34 (9)
DX3	P2N-YM518ES	7.48 (190)	2.20 (56)	1.34 (34)	2.05 (52)	1.03 (26)	1.18 (30)	0.47 (12)

Inches (mm)

D
 Subbase & Manual Valves
 H Series Micro
 Moduflex Series
 H Series ISO
 Network Connectivity
 DX ISOMAX Series
 Valvair II Series



For inventory, lead times, and kit lookup, visit www.pdnplu.com

D270

Parker Hannifin Corporation
 Pneumatic Division
 Richland, Michigan
www.parker.com/pneumatics

Valvair II Series

- Full air operation for fastest response
- “Plug-in” option simplifies maintenance and installation
Reduces downtime. No wiring or plumbing to disturb
- “Direct pipe” design for economy and performance
- Variety of operators available; direct conduit, (JIC) junction box, NEMA 4, hazardous duty, (UL, CSA), and remote air pilot
- Field convertible to external pilot supply for vacuum or other services
- Synthetic rubber o-ring seals are specially compounded for minimum compression and friction for superior wear and abrasion resistance
- Precision ground spool “floats” on o-ring seals. Closed center cross-over design saves air
- General Purpose Approvals
 - CSA - Canadian Standards Association
File number 42024
- Hazardous Duty Approvals
 - UL - Underwriters Laboratories, Inc.
File number E42542 Category Y107
 - CSA - Canadian Standards Association
File number 24349

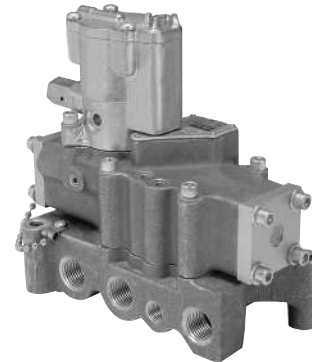

Material specifications

Manifolds & subbases	Aluminum alloy	
Other seals	Nitrile	
Resilient seals: in valve body		
Dynamic	Polyurethane base on 3/8" basic valves*	
Static / dynamic	Nitrile base w / 12% Molybdenum Disulphide on 1/4" & 1/2" basic valves	
Shock pads	Polyurethane	
Solenoid bodies	Plated zinc alloy	
Internal components	Corrosion resistant steel	
Resilient seals	Standard service	Nitrile
	Special service (continuous duty)	Fluorocarbon & Silicone
Other seals	Nitrile	
Coil	Class “B” epoxy encapsulated (Class “H” also available on some models, consult supplier)	
Valve bodies	Aluminum alloy	
Valve spacers	Brass	
Valve spool	Aluminum alloy with special coating on 3/8" basic valves*. Hard chrome plated AISI type 416 stainless steel on 1/4" & 1/2" basic valves.	

* These materials are specially designed for valves used on non-lubricated service

Most popular.

Operating information

Pressure range for solenoid operated valves

Media	Internal pilot supply			External pilot supply			
	1/4"	3/8"	1/2"	1/4"	3/8"	1/2"	1"
Air	35-140* PSIG			N.A. Main	0-250 PSIG		
				Pilot	35-140* PSIG		
Vacuum	do not use			N.A. Main	within 1 Hg of perfect		
				Pilot	35-140* PSIG		

Other Consult supplier

* 200 PSIG solenoid is optional (consult supplier).

Pressure range for remote pilot operated valves

Media		Valve type	
		Single	Double & 3-position
Air	Main	35-250 PSIG	0-250 PSIG
	Pilot	35-200 PSIG	35-200 PSIG
Vacuum	Main	Do not use	Within 1" Hg of perfect
	Pilot	Do not use	35-200 PSIG
Other	Consult supplier		

Ambient temperature – standard service solenoid operator

Minimum	Maximum	
	Intermittent duty	Continuous duty
0°F	125°F	100°F
Special service (continuous duty) solenoid operator		
0°F	125°F	125°F

Ambient temperature – remote pilot operated valves

0°F	200°F
-----	-------

As the above chart indicates, Standard Duty Solenoids may be used on continuous duty but ambient temperature is de-rated.

In some cases, Special Service Solenoids may be rated for higher ambient temperatures (consult supplier).



CAUTION:

If it is possible that the ambient temperature may fall below freezing, the medium must be moisture free to prevent internal damage and unpredictable behavior.



For inventory, lead times, and kit lookup, visit www.pdnplu.com

D271

Parker Hannifin Corporation
Pneumatic Division
Richland, Michigan
www.parker.com/pneumatics

D

Subbase & Manual Valves

H Series Micro

Modulflex Series

H Series ISO

Network Connectivity

DX ISOMAX Series

Valvair II Series

3/8" Basic plug-in solenoid valve only with light

Symbol	Type	Cv	Operator	Voltage	Non-Locking	Locking
	4-way, 2-position, spring return	4.8	Single solenoid	24 VDC 110 VAC	L6753810249 L6753810253	L6753910249 L6753910253
	4-way, 2-position	4.8	Double solenoid	24 VDC 110 VAC	L6553810249 L6553810253	L6553910249 L6553910253
	4-way, 3-position, all ports blocked	4.8	Double solenoid	24 VDC 110 VAC	L6653821149 L6653821153	L6653921149 L6653921153
	4-way, 3-position, center exhaust	4.8	Double solenoid	24 VDC 110 VAC	L6653822149 L6653822153	L6653922149 L6653922153
	4-way, 3-position, pressure center	4.8	Double solenoid	24 VDC 110 VAC	L6653823149 L6653823153	L6653923149 L6653923153

* Order subbase or manifold separately.

3/8" Basic plug-in remote pilot valve only

Symbol	Type	Cv	Operator	Part Number
	4-way, 2-position, spring return	4.8	Single remote	L67431102
	4-way, 2-position	4.8	Double remote	L65431102
	4-way, 3-position, all ports blocked	4.8	Double remote	L66431211
	4-way, 3-position, center exhaust	4.8	Double remote	L66431221
	4-way, 3-position, pressure center	4.8	Double remote	L66431231

* Order subbase or manifold separately.

3/8" Valve Subbase and Manifolds

	Cv	Port	Subbase † (side ports)	Manifolds † (end & bottom ports)
Subbase	4.8	3/8"	K022090	K142230
Manifold	4.8	1/2"	K022091	K142231
	4.8	3/4"	K022101	K142270

† Manifolds include mounting hardware, except for port adapters. Subbase includes valve mounting hardware.

Plug-in Subbase, 3/8" Basic

- K022090Inlet & Cylinder Ports 3/8" NPTF
- Exhaust ports 1/2" NPTF
- K022091Inlet & Cylinder Ports 1/2" NPTF
- Exhaust ports 1/2" NPTF
- K022101Inlet & Cylinder Ports 3/4" NPTF
- Exhaust port 3/4" NPTF
- Conduit port 1/2" NPTF

Note: Subbase assemblies include mounting hardware.

Most popular.

Plug-in Manifold, 3/8" Basic

- K142230Cylinder ports 3/8" NPTF
- K142231Cylinder ports 1/2" NPTF
- K142270Cylinder ports 3/4" NPTF
- Exhaust port..... 1" NPTF
- Inlet port..... 1" NPTF
- Conduit port..... 1-1/4" NPTF

Note: Manifold assemblies include mounting hardware.

D
Subbase & Manual Valves
H Series Micro
Modulflex Series
H Series ISO
Network Connectivity
DX ISOMAX Series
Valvair II Series







For inventory, lead times, and kit lookup, visit www.pdnplu.com

D272

Parker Hannifin Corporation
Pneumatic Division
Richland, Michigan
www.parker.com/pneumatics



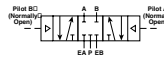

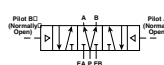
Common Part Numbers

1" Basic plug-in solenoid valve only with light

Symbol	Type	Cv	Operator	Voltage	Non-Locking	Locking
	4-way, 2-position, spring return	11.3	Single solenoid	24 VDC 110 VAC	L6758810249 L6758810253	L6758910249 L6758910253
	4-way, 2-position	11.3	Double solenoid	24 VDC 110 VAC	L6558810249 L6558810253	L6558910249 L6558910253
	4-way, 3-position, all ports blocked	11.3	Double solenoid	24 VDC 110 VAC	L6658821149 L6658821153	L6658921149 L6658921153
	4-way, 3-position, center exhaust	11.3	Double solenoid	24 VDC 110 VAC	L6658822149 L6658822153	L6658922149 L6658922153
	4-way, 3-position, pressure center	11.3	Double solenoid	24 VDC 110 VAC	L6658823149 L6658823153	L6658923149 L6658923153

* Order subbase separately.

1" Basic plug-in valve remote pilot valve only

Symbol	Type	Cv	Operator	Part Number
	4-way, 2-position, spring return	11.3	Single remote	L67481102
	4-way, 2-position	11.3	Double remote	L65481102
	4-way, 3-position, all ports blocked	11.3	Double remote	L66481211
	4-way, 3-position, center exhaust	11.3	Double remote	L66481221
	4-way, 3-position, pressure center	11.3	Double remote	L66481231

* Order subbase separately.

1" Valve Subbase

	Cv	Port	Subbase † (side ports)
	11.3	1"	K022095

Subbase

† Subbase includes valve mounting hardware.

Plug-in Subbase, 1" Basic

K022095 Inlet & Cylinder Ports 1" NPTF
 Exhaust ports 1-1/4" NPTF
 Conduit port 1/2" NPTF

Note: Subbase assemblies include mounting hardware.



For inventory, lead times, and kit lookup, visit www.pdnplu.com

D273

Parker Hannifin Corporation
 Pneumatic Division
 Richland, Michigan
www.parker.com/pneumatics

D

Subbase & Manual Valves

H Series Micro

Modulflex Series

H Series ISO

Network Connectivity

DX ISOMAX Series

Valvair II Series

3/8" Basic direct pipe ported valve only. Solenoid junction box with light, 1/2" NPT ports

Symbol	Type	Cv	Operator	Voltage	Non-Locking	Locking
	4-way, 2-position, spring return	4.8	Single solenoid	24 VDC 110 VAC	L7054810249 L7054810253	L7054910249 L7054910253
	4-way, 2-position	4.8	Double solenoid	24 VDC 110 VAC	L6854810249 L6854810253	L6854910249 L6854910253
	4-way, 3-position, all ports blocked	4.8	Double solenoid	24 VDC 110 VAC	L6954821149 L6954821153	L6954921149 L6954921153
	4-way, 3-position, center exhaust	4.8	Double solenoid	24 VDC 110 VAC	L6954822149 L6954822153	L6954922149 L6954922153
	4-way, 3-position, pressure center	4.8	Double solenoid	24 VDC 110 VAC	L6954823149 L6954823153	L6954923149 L6954923153

3/8" Basic direct pipe ported remote pilot valve only, 1/2" NPT ports

Symbol	Type	Cv	Operator	Part Number
	4-way, 2-position, spring return	4.8	Single remote	L70441102
	4-way, 2-position	4.8	Double remote	L68441102
	4-way, 3-position, all ports blocked	4.8	Double remote	L69441211
	4-way, 3-position, center exhaust	4.8	Double remote	L69441221
	4-way, 3-position, pressure center	4.8	Double remote	L69441231

D
Subbase & Manual Valves
H Series Micro
Modulflex Series
H Series ISO
Network Connectivity
DX ISOMAX Series
Valvair II Series

Most popular.











For inventory, lead times, and kit lookup, visit www.pdnplu.com

D274

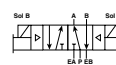

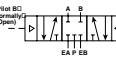

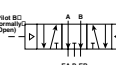

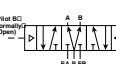

Parker Hannifin Corporation
Pneumatic Division
Richland, Michigan
www.parker.com/pneumatics

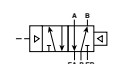
Common Part Numbers

1" Basic direct pipe ported valve only. Solenoid junction box with light, 1" NPT ports

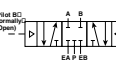
Symbol	Type	Cv	Operator	Voltage	Non-Locking	Locking
		4-way, 2-position, spring return	11.3	Single solenoid	24 VDC 110 VAC	L7058810249 L7058910249
		4-way, 2-position	11.3	Double solenoid	24 VDC 110 VAC	L6858810249 L6858910249
		4-way, 3-position, all ports blocked	11.3	Double solenoid	24 VDC 110 VAC	L6958821149 L6958921149
		4-way, 3-position, center exhaust	11.3	Double solenoid	24 VDC 110 VAC	L6958822149 L6958922149
		4-way, 3-position, pressure center	11.3	Double solenoid	24 VDC 110 VAC	L6958823149 L6958923149

1" Basic direct pipe ported remote pilot valve only. 1" NPT ports

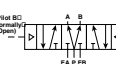
Symbol	Type	Cv	Operator	Part Number	
		4-way, 2-position, spring return	11.3	Single remote	L70481102
		4-way, 2-position	11.3	Double remote	L68481102
		4-way, 3-position, all ports blocked	11.3	Double remote	L69481211
		4-way, 3-position, center exhaust	11.3	Double remote	L69481221
		4-way, 3-position, pressure center	11.3	Double remote	L69481231



For inventory, lead times, and kit lookup, visit www.pdnplu.com

D275

Parker Hannifin Corporation
 Pneumatic Division
 Richland, Michigan
www.parker.com/pneumatics

D

Subbase & Manual Valves

H Series Micro

Modulflex Series

H Series ISO

Network Connectivity

DX ISOMAX Series

Valvair II Series

Lubricated Non-Lubricated Service
2-position, Plug-In, 3/8" & 1" Basic Size

L 67 5 3 9 10 2 53

Type	
Double	65
Single	67

Operator	
Remote	4
Solenoid	5

Size	
3/8" Basic	3
1" Basic	8

Operator options	
Solenoid (basic) or Remote	1
Solenoid with Locking Override	3
Solenoid w/Light (120VAC, 24VDC) & Non-Locking Override	8
Solenoid w/Light (120VAC, 24VDC) & Locking Override	9

Voltage & Frequency			
	60Hz	50Hz	DC
45			12
49			24
53	120	110	
57	240	220	
Blank	Remote		

Duty Cycle	
2	Standard Service, Solenoid or Remote
4	Continuous Service Solenoid

Enclosure "Class"	
10	Standard (NEMA 1 & 12) or Remote

D
 Subbase & Manual Valves
 H Series Micro
 Modulflex Series
 H Series ISO
 Network Connectivity
 DX ISOMAX Series
 Valvair II Series

Lubricated or Non-Lubricated Service
3-position, Plug-In, 3/8" & 1" Basic Size

L 66 5 3 9 21 1 53

Type	
Double	66

Operator	
Remote	4
Solenoid	5

Size	
3/8" Basic	3
1" Basic	8

Operator options	
Solenoid (basic) or Remote	1
Solenoid with Locking Override	3
Solenoid w/Light (120VAC, 24VDC) & Non-Locking Override	8
Solenoid w/Light (120VAC, 24VDC) & Locking Override	9

Voltage & Frequency			
	60Hz	50Hz	DC
45			12
49			24
53	120	110	
57	240	220	
Blank	Remote		

Duty Cycle	
1	Standard Service, Solenoid or Remote
5	Continuous Service Solenoid

Enclosure "Class"	
21	All Ports Blocked In Neutral (NEMA 1 & 12 enclosure) or Remote
22	Cyl. Ports Open to Exhaust in Neutral (NEMA 1 & 12 enclosure) or Remote
23	Cyl. Ports Open to Inlet in Neutral (NEMA 1 & 12 enclosure) or Remote

Most popular.



For inventory, lead times, and kit lookup, visit www.pdnplu.com

D276

Parker Hannifin Corporation
Pneumatic Division
Richland, Michigan
www.parker.com/pneumatics

Ordering Information

Lubricated or Non-Lubricated Service
2-position, Direct Pipe Ported, 3/8" & 1" Basic Size

L 70 5 3 9 10 2 53 —

Type	
Double	68
Single	70

Operator	
Remote	4
Solenoid	5

Size	
3/8" NPT Inlet & Cylinder 1/2" NPT Exhaust	3
1/2" NPT Inlet, Cylinder & Exhaust	4
1" NPT Inlet & Cylinder 1-1/4" NPT Exhaust	8
1-1/4" NPT Inlet Cylinder & Exhaust	9*

Lead Length	
Blank	19" (Standard)

Voltage & Frequency			
	60Hz	50Hz	DC
45			12
49			24
53	120	110	
57	240	220	
Blank	Remote		

Duty Cycle	
2	Standard Service, Solenoid or Remote
4	Continuous Service Solenoid

Enclosure "Class"	
10	Standard (NEMA 1 & 12) or Remote
60*†	Hazardous Duty (NEMA 7 & 9)
80†	NEMA 4

* Voltage 49 / 53 only.
† Use with operator options 1 & 3 only.

Operator options	
Solenoid (basic) or remote	1
Solenoid with locking override	3
Solenoid w/ junction box & locking override	6
Solenoid w/ junction box & light (120VAC, 24VDC) & non-locking override	8
Solenoid w/ junction box & light (120VAC, 24VDC) & locking override	9

Lubricated or Non-Lubricated Service
3-position, Direct Pipe Ported, 3/8" & 1" Basic Size

L 69 5 3 9 21 1 53 —

Type	
Double	69

Operator	
Remote	4
Solenoid	5

Size	
3/8" NPT Inlet & Cylinder 1/2" NPT Exhaust	3
1/2" NPT Inlet, Cylinder & Exhaust	4
1" NPT Inlet & Cylinder 1-1/4" NPT Exhaust	8
1-1/4" NPT Inlet Cylinder & Exhaust	9*

Lead Length	
Blank	19" (Standard)

Voltage & Frequency			
	60Hz	50Hz	DC
45			12
49			24
53	120	110	
57	240	220	
Blank	Remote		

Duty Cycle	
1	Standard Service, Solenoid or Remote
5	Continuous Service Solenoid

Enclosure "Class"	
All Ports Blocked in Neutral	
21	Standard (NEMA 1 & 12) or Remote
71*†	Hazardous Duty (NEMA 7 & 9)
91†	NEMA 4
Cylinder Ports Open to Exhaust in Neutral	
22	Standard (NEMA 1 & 12) or Remote
72*†	Hazardous Duty (NEMA 7 & 9)
92†	NEMA 4
Cylinder Ports Open to Inlet in Neutral	
23	Standard (NEMA 1 & 12) or Remote
73*†	Hazardous Duty (NEMA 7 & 9)
93†	NEMA 4

* Voltage 49 / 53 only.
† Use with operator options 1 & 3 only.

 Most popular.



For inventory, lead times, and kit lookup, visit www.pdnplu.com

D277

Parker Hannifin Corporation
Pneumatic Division
Richland, Michigan
www.parker.com/pneumatics

D

Subbase & Manual Valves

H Series Micro

Modulflex Series

H Series ISO

Network Connectivity

DX ISOMAX Series

Valvair II Series

Modular Pneumatic Controls Plug-In Sandwich Block Design for Modular Port Regulation

These modular regulators assemble to any 3/8" basic valve interface pattern.

Port Regulation Made Easy

Place the sandwich on the manifold or subbase, tighten the four securing screws, then plug the valve into the sandwich and tighten its securing screws to complete the assembly.

Within minutes, these modular components can be installed in new, or used to improve existing manifold systems, without disturbing wiring or air connections.

3-Configurations

1. **Common Port Regulation** - A common regulated pressure is selected to both cylinder ports.
2. **Single Port Regulation** - Line pressure is available to one cylinder port, while a single regulated pressure is selected to the other cylinder port.
3. **Independent Port Regulation** - Two independently regulated pressures selected to the cylinder ports.

NOTE: When using single or independent port sandwich regulators, be aware that:

1. Cylinder port outlets are reversed.
2. 3-Position, cylinder ports open to exhaust and cylinder ports open to inlet functions are reversed. To produce a cylinder ports open to exhaust function, order valve with cylinder ports open to inlet. To produce a cylinder ports open to inlet function, order valve with cylinder ports open to exhaust.

Manual or Remote secondary pressure adjustment.

Three Pressure Ranges are standard for manual units:

- 1-30 PSIG
- 1-60 PSIG
- 2-125 PSIG

Range for Remote: 0-140 PSIG

Gauges are furnished standard; liquid filled gauges are optional.



Solenoid Valve Assembly



Regulator Assembly



Manifold

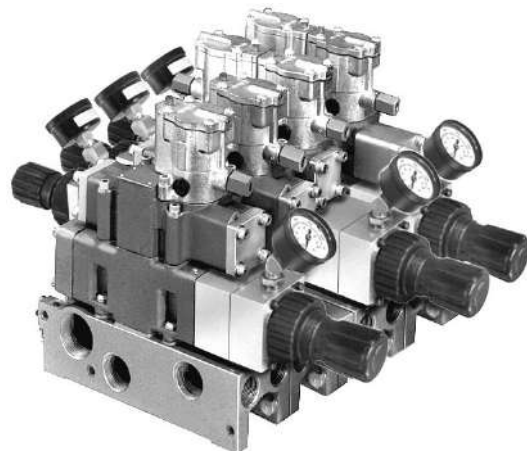

Typical Assembly

D
 Subbase & Manual Valves
 H Series Micro
 Modulflex Series
 H Series ISO
 Network Connectivity
 DX ISOMAX Series
 Valvair II Series



For inventory, lead times, and kit lookup, visit www.pdnplu.com

Function - Single Port Regulation

This modular air pressure regulator assembly, when installed between a 3/8" basic, 4-Way valve and subbase or modular manifold, supplies one or more regulated pressures to one of the valve cylinder ports and supply pressure to the other cylinder port.

On Single Port Cylinder Port Regulation Units controlled by a single solenoid valve, cylinder port "B" is the normally open cylinder port. The solenoid is energized to open cylinder Port "A". On double solenoid operated valves, energizing solenoid "B" opens cylinder port "A" and energizing solenoid "A" opens cylinder port "B".

Valve must be converted to external pilot supply.

Features

Regulated pressure output from the valve is adjusted by knob on the manually set model or by air pressure signal applied to the regulator pilot port on the remotely set model.

For reduced pressure at "A" cylinder port, the regulator is mounted per assembly "A" on end opposite the electrical junction box. For reduced pressure at "B" cylinder port the regulator is mounted per Assembly "B" which places the regulator over the electrical junction box.

Furnished with pressure gauge as standard.

Pressure Range Options

Maximum Supply Pressure	140 PSIG
Output Pressure Range	1 - 30 PSIG
	1 - 60 PSIG
	2 - 125 PSIG

Operating Temperature Range

32°F (0°C) to 175°F (79°C)

How To Order

1. Select type of adjustment.
2. Select pressure range.
3. Select assembly style.

Example: Manual adjustment.
5-60 PSIG, Port A reduced.

Model No. L55405307C

Relief and Flow Characteristics

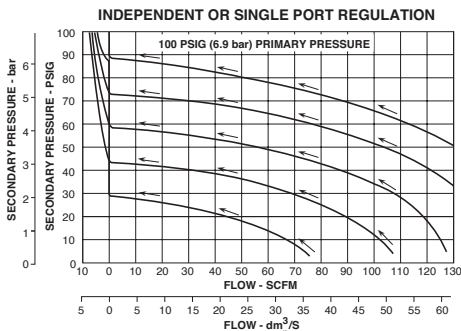

The above curves illustrate flow characteristics through an assembled valve, air regulator, and base (or modular manifold) unit.

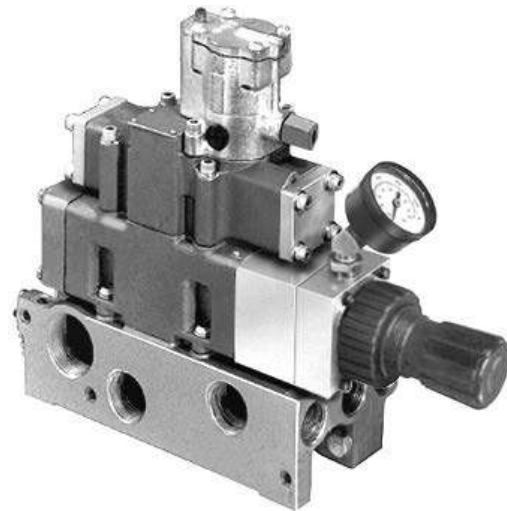

Assembly "A"

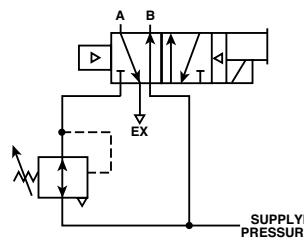

Supply Pressure at "B" & Regulated at "A"

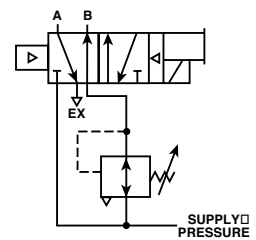

Supply Pressure at "A" & Regulated at "B"

Pressure Adjustment	Pressure Range PSIG	Model Number	
		Reduced Pressure Cyl. Port "A"	Cyl. Port "B"
Manual	1 - 60	L55405307C	L55407305C
	2 - 125	L55406307C	L55407306C
Remote	0 - 140	L55414307C	L55407314C

Note: When using single or independent port sandwich regulators, be aware that:

1. Cylinder port outlets are reversed.
2. 3-Position, cylinder ports open to exhaust and cylinder ports open to inlet functions are reversed. To produce a cylinder ports open to exhaust function, order valve with cylinder ports open to inlet. To produce a cylinder ports open to inlet function, order valve with cylinder ports open to exhaust.

See parts and accessories for gauges.

D
 Subbase & Manual Valves
 H Series Micro
 Moduteflex Series
 H Series ISO
 Network Connectivity
 DX ISOMAX Series
 Valvair II Series



For inventory, lead times, and kit lookup, visit www.pdnplu.com

Manual Adjusting

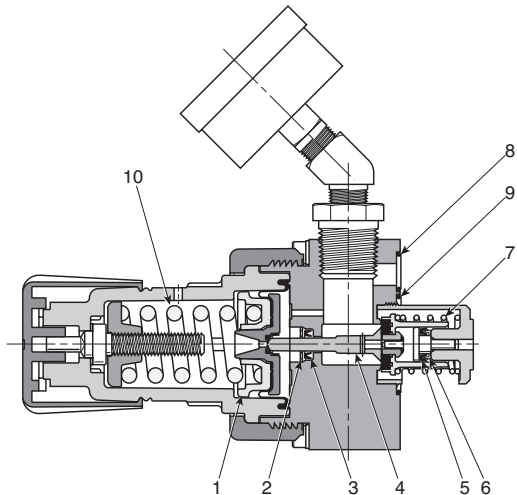

Remote Operated

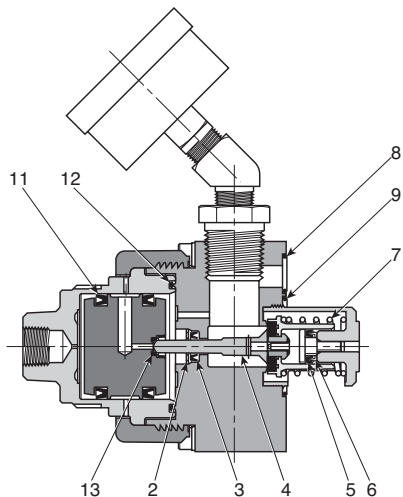

Replacement Parts

Item no.	Part Number	Description
1	○	Diaphragm Assembly
2	○ ●	Retaining Ring
3	○ ●	Vee Packing
4	○ ●	Poppet Assembly
5	○ ●	Vee Packing
6	○ ●	Backflow Retainer
7	○ ●	Poppet Spring
8	○ ●	.989 ID x .070 W O-Ring
9	○ ●	1.301 ID x .070 W O-Ring
	P01698	1-30 PSI Spring
10	P04062	1-60 PSI Spring (Blue)
	P04063	2-125 PSI Spring
11	●	Vee Packing
12	●	1.674 ID x .103 W O-Ring
13	●	Vent Seal

○ Parts included in K352409 service kit for manual operated modular regulators.

● Parts included in K352411 service kit for remote operated modular regulators.

Replacement Gauges

PSIG	Standard
0-60	K4520N14060
0-160	K4520N14160
0-300	K4520N14300

Suggested Schematic of Assembled Valve, Air Regulation and Modular Manifold Units

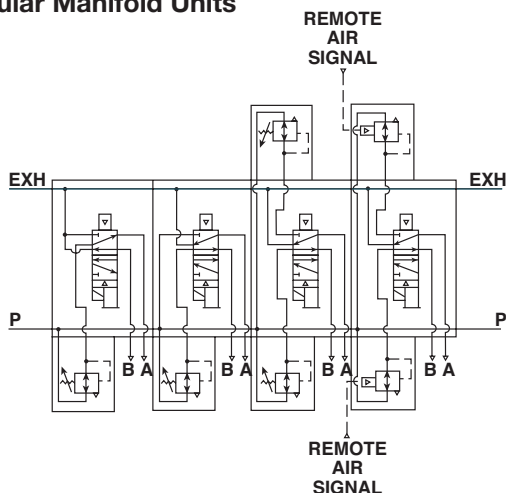

D

Subbase & Manual Valves

H Series Micro

Modulflex Series

H Series ISO

Network Connectivity

DX ISOMAX Series

Valvair II Series



For inventory, lead times, and kit lookup, visit www.pdnplu.com

Common Port Regulation

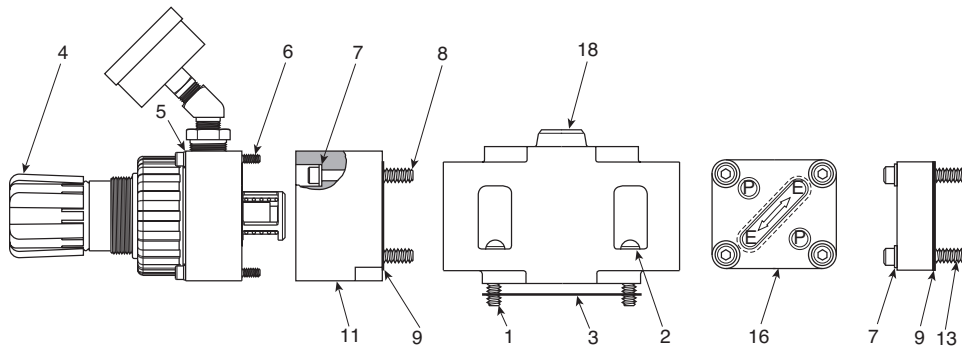

Single Port Regulation

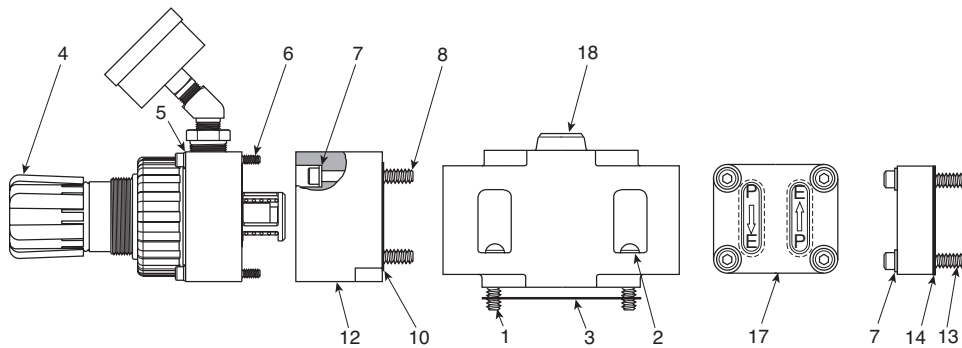

Independent Port Regulation

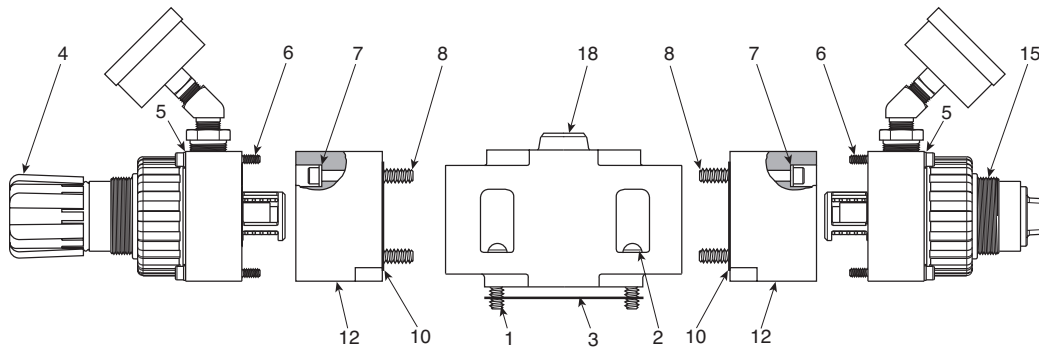

Table "E": Parts

Item No.	Part Number	Description
1	H09815	Screw (4)
2	H17512	Lockwasher (4)
3	K183077	Gasket
4	Standard	Manual Reg. Assy. (w/Gauge)
	K472001C	1-30 PSIG
	K472002C	1-60 PSIG
5	K472003C	2-125 PSIG
	H17509	#10 Lockwasher
	H10032	#10-32 x 1.75" Lg. SHCS
7	H17511	1/4" Lockwasher
8	H10069	1/4-20 x 2.25" Lg. SHCS

Item No.	Part Number	Description
9	K183082	Gasket
10	K183084	Gasket
11	K043012	Function Block (P to P)
12	K043011	Function Block (P to E)
13	H100107	1/4-20 x 1-1/2" Lg. SHCS
14	K183083	Gasket
15	Standard	Remote Reg. Assy. (w/Gauge)
	K472009C	0-140 PSIG
16	K362308	Function Plate Assy. (Incl. 7, 9, 13)
17	K362307	Function Plate Assy. (Incl. 7, 13, 14)
18	K032270	Body Assy. (Incl. 1, 2, 3)



For inventory, lead times, and kit lookup, visit www.pdnplu.com

D283

Parker Hannifin Corporation
 Pneumatic Division
 Richland, Michigan
www.parker.com/pneumatics

D

Subbase & Manual Valves

H Series Micro

Modulflex Series

H Series ISO

Network Connectivity

DX ISOMAX Series



Valvair II Series

Plug-in Pilot

	Description	Standard Service		Special Service	
	Override type	Locking	Non-locking	Locking	Non-locking
With indicator light	With override (120VAC)	K175903553	K175803553	K185902553	K185802553
	With override (Other than 120VAC)	K1753035**	—	K1853025**	—



** Voltage code - (reference model index for availability)

NEMA 1 & 12

	Description	Standard Service		Special Service	
	Override type	Locking	Non-locking	Locking	Non-locking
Basic Pilot	Basic with override	K0653035**	—	K0853025**	—
	JIC with junction box & override	K0656035**	K0655035**	K0856025**	K0855025**
	JIC pilot with junction box & override & indicator lights (120VAC Only)	K0659035**	K0658035**	K0859025**	K0858025**

** Voltage code - (reference model index for availability)

NEMA 4, 7 & 9

	Description	Standard Service		Special Service	
	Override type	Locking	Non-locking	Locking	Non-locking
Hazardous Duty	Hazardous duty pilot - UL & CSA	K0251035**†	—	K0451025**†	—
	NEMA 4 pilot	K2351035**†	—	—	—
	Hazardous duty with override	K0253035**†	K0252035**†	K0453025**†	K0452025**†
	NEMA 4 with override	—	K2353035**†	K2352035**†	—

† 49 / 53 only ** Voltage code - (reference model index for availability)

Replacement Solenoid Coil



Voltage Code	Voltage			DC	Coil Number	
	60 Hz	50 Hz	24 [†]		Plug-In	Flying lead (19") *
**	60 Hz	50 Hz	24 [†]			
49	—	—	24 [†]	K593060 K593274[‡]	K593014	
53	120 [†]	110	—	K593071 K593125[‡]	K593025	
57	240 [†]	220	—	K593081	K593035	

Notes: **Bold Face** type indicated primary coil rating.
 † Indicates voltages approved for solenoid operators designed for use in hazardous locations.
 * 19" Coil lead length is standard. Other lead lengths may be available, consult supplier.
 ‡ Assembly includes indicator light socket, less light.

Solenoid Characteristics Chart

Voltage Range +10/-15% of Nominal

3/8" & 3/4" Basic - L-Pilot

Voltage/Cycles	Amps Inrush	Amps Holding	Resistance Ohms	Watts	Insulation Class
120/60VAC	.29	.18	122	12	B
110/50VAC	.21	.14	122	12	B
240/60VAC	.18	.12	610	12	B
24/60VAC	1.6	1.0	4.5	9.5	B
24/50VAC	1.2	.75	6.4	9.5	B
6VDC	—	1.4	4.5	7.6	B
12VDC	—	.66	17.7	9	B
24VDC	—	.32	71	9	B
48VDC	—	.22	216	11	B

D
 Subbase & Manual Valves
 H Series Micro
 Modutefx Series
 H Series ISO
 Network Connectivity
 DX ISOMAX Series
 Valvair II Series



For inventory, lead times, and kit lookup, visit www.pdnplu.com

Service Kits

To use this chart you must know the basic valve series, quantity, and type of operators, or the first three characters of the valve model number.

Basic Valve	Solenoid Operated *						
	Series (prefix)	Standard Service (intermittent duty)		Special Service ** (continuous duty)		Remote Pilot Operated	
Size		Single	Double 2 & 3-Position	Single	Double 2 & 3-Position	Single	Double 2 & 3-Position
3/8"	L65	—	K352126	—	K352127	—	K352355
	L66	—	K352126	—	K352127	—	K352355
	L67	K352124	—	K352125	—	K352362	—
	L68	—	K352126	—	K352127	—	K352355
	L69	—	K352126	—	K352127	—	K352355
	L70	K352124	—	K352125	—	K352362	—
	L65	—	K352130	—	K352131	—	K352360
1"	L66	—	K352130	—	K352131	—	K352360
	L67	K352128	—	K352129	—	K352359	—
	L68	—	K352130	—	K352131	—	K352360
	L69	—	K352130	—	K352131	—	K352360
	L70	K352128	—	K352129	—	K352359	—

Notes:

* Kits for solenoid operated valves include solenoid service kits.

** Special service (continuous duty) solenoids may be identified as having gold colored solenoid tops.

Blank Plate Kit - 3/8" Basic

Manifold Assembly	Port size	Part Number
K142230	3/8"	K06020003
K142231	1/2"	
K142270	3/4"	

Kit includes: Blank plate, gasket, mounting screws.

Conversion Kits: Lubricated to Non-Lubricated Operation

Basic Size	Operators (solenoid or remote pilot)	
	Single	Double (2-position)
3/8"	K322012	K322013

Flush Type Hex Drive Pipe Plugs for Port Isolation

Size (NPTF)	Part Number
1/8"	K21R02012L
1/4"	K21R02025L
3/8"	K21R02037L
1/2"	K21R02050L
3/4"	K21R02075L

Electrical Connectors Single or Double Solenoid Valves

Basic Size	Valve Body		Subbase / Manifold	
	Single Solenoid	Double Solenoid	10" Leads	72" Leads
3/8"	H02723	H02722	H02713	H02789
1"				

Interchangeable Manual Override Assemblies for Solenoid Operators



Non-Locking Type	Locking Type
K162001	K152003

To override valve, use a flat head screwdriver to press in and rotate plunger 90° until plunger locks in place. For proper valve operation, override should be in the out position.



For inventory, lead times, and kit lookup, visit www.pdnplu.com

Plug-In
 De-Energized

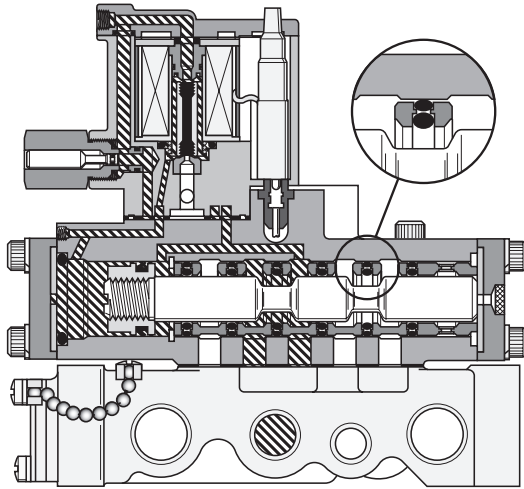

Direct Pipe Ported
 De-Energized

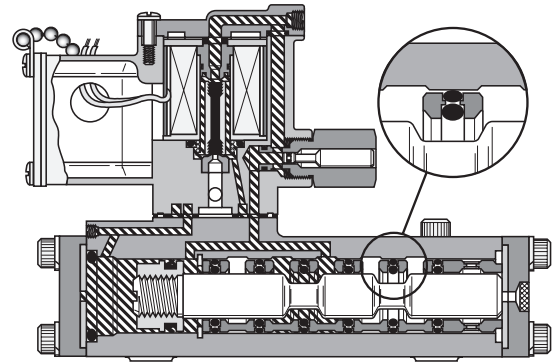

Energized

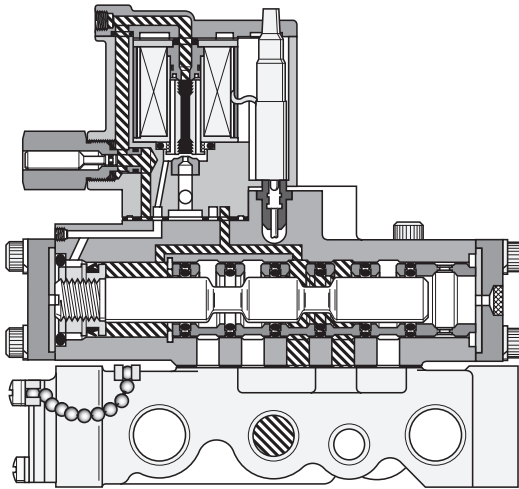

Energized

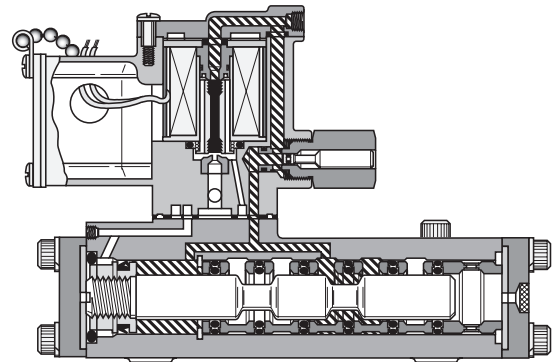

 **Pressure**  **Exhaust**

D	Subbase & Manual Valves
H Series Micro	
Modulflex Series	
H Series ISO	
Network Connectivity	
DX ISOMAX Series	
Valvair II Series	



For inventory, lead times, and kit lookup, visit www.pdnplu.com

D286

Parker Hannifin Corporation
 Pneumatic Division
 Richland, Michigan
www.parker.com/pneumatics

Flow Capacities

Valve Type	Cylinder Port Size (NPTF)	Mounting Style	Cv Flow Rating Inlet to Cylinder "A"
3/8" Single	3/8"	Direct Pipe	4.7
	1/2"	Direct Pipe	5.3
3/8" Double	3/8"	Direct Pipe	4.5
	1/2"	Direct Pipe	5.5
	3/4"	Subbase	5.0
	3/4"	Manifold	4.9
3/8" Double 3-Position	3/8"	Direct Pipe	4.1
	1/2"	Direct Pipe	4.5
	3/4"	Subbase	4.5
	3/4"	Manifold	4.1
1" Single & Double	1"	Direct Pipe	12.0
		Subbase	11.3

Recommended Filtration

Maintained 40 Micron Filtration

Life Expectancy

Valves designed for non-lubricated service as well as those designed for lubricated service will provide millions of maintenance free cycles. Under laboratory conditions service life exceeds 25,000,000 cycles.

Factory Pre-Lubrication

Valves are lubricated at assembly with Sunaplex 781 or equivalent. Valves specified for vacuum service are lubricated with Dow Corning Valve Seal A.

Valves for Non-Lubricated Service

3/8" basic valve sizes are designed to operate in applications where in-service lubrication is not desirable. Valves are factory pre-lubed as noted above. These valves may be used for lubricated service as well.

Lubrication

Air Line Lubricant (compatible with Nitrile & Polyurethane seals) must readily atomize and be of the medium aniline type. Aniline point range must be between 180° and 220°F. Viscosity @ 100°F: 140-170 SUS.

Recommended Lubricant

If in-service lubrication is required, use F442 oil, or equivalent. F442 is specially formulated to provide peak performance and maximum service life for air operated equipment.

Subbase & Manifold Valve Products Valvair II Series

Listing Agencies

General Purpose Approvals

CSA - Canadian Standards Association
 File Number 42024

Hazardous Duty Approvals

UL - Underwriters Laboratories, Inc.
 File Number E42542
 Category Y107

CSA - Canadian Standards Association
 File Number 24349

Solenoid Enclosure Ratings

Type	Listing Agency	NEMA Rating	Description
Plug-In	CSA	1 & 12	General purpose indoor only dust tight
Conduit / flying lead	CSA	1 & 12	General purpose indoor only dust tight
* Conduit (as specified)	UL & CSA	7 & 9	Hazardous location see chart below)
* Conduit (as specified)	CSA	4	General purpose indoor / outdoor

* See ordering information on specific valve type. (Direct Pipe Ported Valves Only.)

Hazardous Duty Solenoid Listing

Valves with solenoid operators designated for hazardous locations are UL & CSA Approved as follows:

National Electric Code	Ambient Conditions	NEMA Classification
Class I Div. 1 Group C	Ethyl, Ether, Etc., Gases & Vapors	VII (7)
Class I Div. 1 Group D	Gasoline, Etc., Gases & Vapors	VII (7)
Class I Div. 2 Group B	Butadiene, Etc., Liquid, Fluid or Vapor Normally Contained, or Atmosphere Ventilated	VII (7)
Class II Div. 1 Group E	Metal Dust	IX (9)
Class II Div. 1 Group F	Coal, Coke, Carbon Black Dust	IX (9)
Class II Div. 1 Group G	Flour, Starch, Grain Dust	IX (9)

See Article 500 - Hazardous (Classified) Locations, National Electric Code.



For inventory, lead times, and kit lookup, visit www.pdnplu.com

D287

Parker Hannifin Corporation
 Pneumatic Division
 Richland, Michigan
www.parker.com/pneumatics

D

Subbase & Manual Valves

H Series Micro

Moduflex Series

H Series ISO

Network Connectivity

DX ISOMAX Series

Valvair II Series

Installation

Valves should be installed with reasonable accessibility for service. Exercise care in keeping piping lengths to a minimum. Piping should be free of dirt, chips & scale. Pipe joint compound should be used sparingly applied only to the thread, never to the valve body. Avoid undue strain at piping joints. Protect the valve from exposure to extreme temperatures, dirt and moisture to maximize life.

Note: Valves equipped with locking manual overrides. Override(s) must be in the fully extended position for proper valve operation.

Double Solenoid / Remote Caution

Note: It is recommended that double solenoid and double remote 2-Position valves be mounted with the main spool in the horizontal plane.

Wiring Instructions for Base Mounted Valves

Single Solenoid:

Use wires marked "2" & "3" for connection. Units with DC Solenoids and indicator lights are polarity sensitive. Wire marked "3" is positive (+).

Double Solenoid:

Use wires marked "1" & "2" for Solenoid "A". Use wires marked "3" & "4" for Solenoid "B". Units with DC Solenoids and indicator lights are polarity sensitive. Wires marked "1" and "3" are positive.

CAUTION:
 DC Solenoids are polarity sensitive.
 Observe polarities indicated above.

Units with Flying Leads

Wires are not polarity sensitive.

CAUTION:
 DC solenoids with indicator lights and / or arc suppression coils are polarity sensitive. Use red wire as positive.

"Special Service" Solenoid (Continuous Duty)

Special Service Solenoids are designed for use when the solenoid duty cycle is greater than 70% or when energization times are for 10 minutes or longer.

These solenoids should be used when valves are to be held energized for hours, days or weeks... or when extended ambient temperature operation is required. Apply the duty cycle formula to determine if this type of solenoid is required.

Duty Cycle Formula

$$\frac{\text{Time Energized}}{\text{Time Energized} + \text{Time Off}} \times 100 = \% \text{ Duty Cycle}$$

If Duty Cycle is 70% or greater, then Special Service (Continuous Duty) Solenoid should be used.

Pilot Supply Conversion

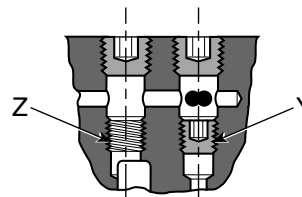

Base Mounted

For field conversion to external pilot supply, remove two 1/8" NPTF plugs from top of valve body and move bottom plug from "Y" to "Z".

Replace 1/8" NPTF plugs and connect pilot pressure to the 1/4" NPTF external pilot supply port "X" in subbase.

Direct Pipe Ported

For field conversion to external pilot supply, remove and discard 1/4" NPTF plug in external pilot supply port "X". Move stored plug "Y" to location "Z" in bottom of pilot supply port "X". Then connect pilot pressure to port "X" in valve body.

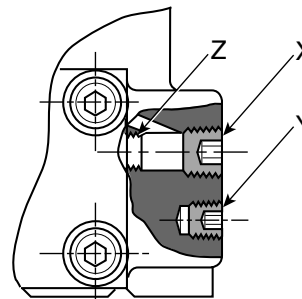

D	Subbase & Manual Valves
	H Series Micro
H Series	Modulflex Series
	ISO
Network Connectivity	DX ISOMAX Series
	Valvair II Series



For inventory, lead times, and kit lookup, visit www.pdnplu.com

* Assembly "A" places the regulator on the end opposite the electrical junction box. Assembly "B" places the regulator over the electrical junction box.

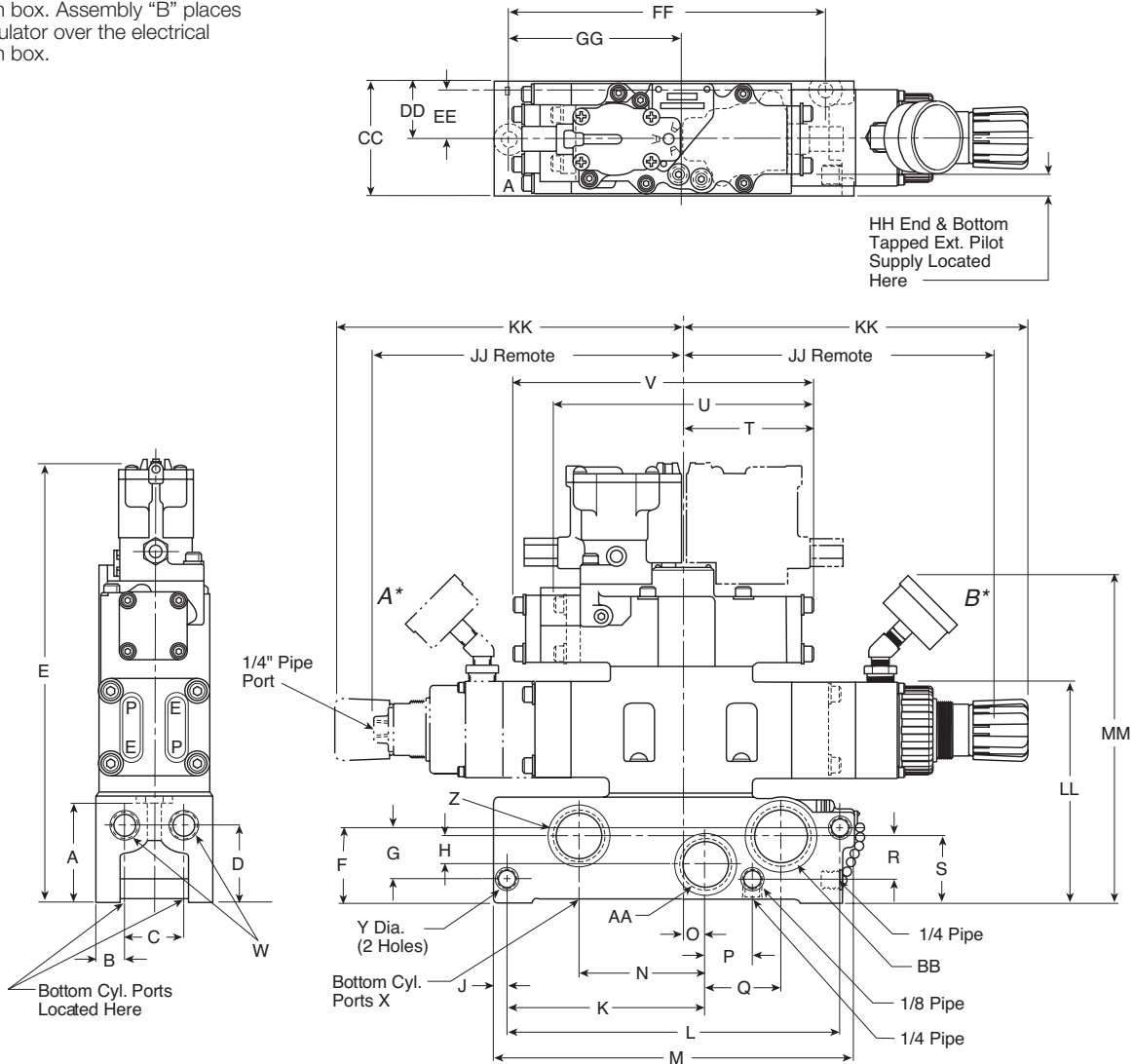

Dimensions - 3/8" Basic Valve

A	B	C	D	E	F	G	H	J	K	L	M	N	O
2.56 (65.0)	.75 (19.1)	1.50 (38.1)	2.09 (53.1)	11.28 (286.5)	2.06 (52.3)	1.41 (35.8)	.75 (19.1)	.34 (8.64)	5.00 (127.0)	8.44 (214.4)	9.09 (230.9)	3.19 (81.0)	.61 (15.5)
P	Q	R	S	T	U	V	W	X	Y	Z	AA	BB	CC
1.19 (30.2)	1.91 (48.5)	1.09 (27.7)	1.81 (46.0)	3.32 (84.3)	6.64 (168.7)	7.56 (192.0)	3/8", 1/2" or 3/4" NPTF		.39 (9.9)	1" NPTF	1" NPTF	1-1/4" NPTF	3.00 (76.2)
DD	EE	FF	GG	HH	JJ	KK	LL	MM					
1.50 (38.1)	1.24 (31.5)	7.97 (202.4)	4.34 (110.2)	.40 (10.2)	8.53 (216.6)	10.15 (257.8)	5.46 (138.6)	8.80 (223.5)					

Inches (mm)



For inventory, lead times, and kit lookup, visit www.pdnplu.com

D289

Parker Hannifin Corporation
 Pneumatic Division
 Richland, Michigan
www.parker.com/pneumatics

D

Subbase & Manual Valves

H Series Micro

Moduflex Series

H Series ISO

Network Connectivity

DX ISOMAX Series

Valvair II Series

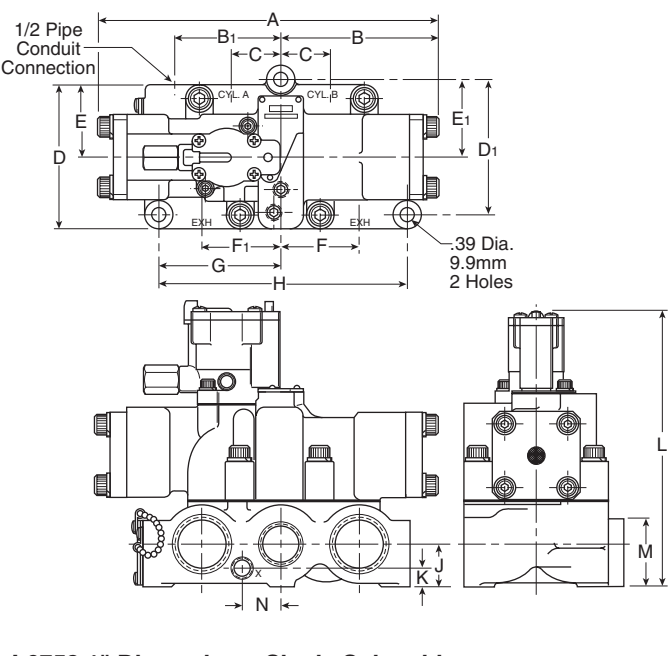
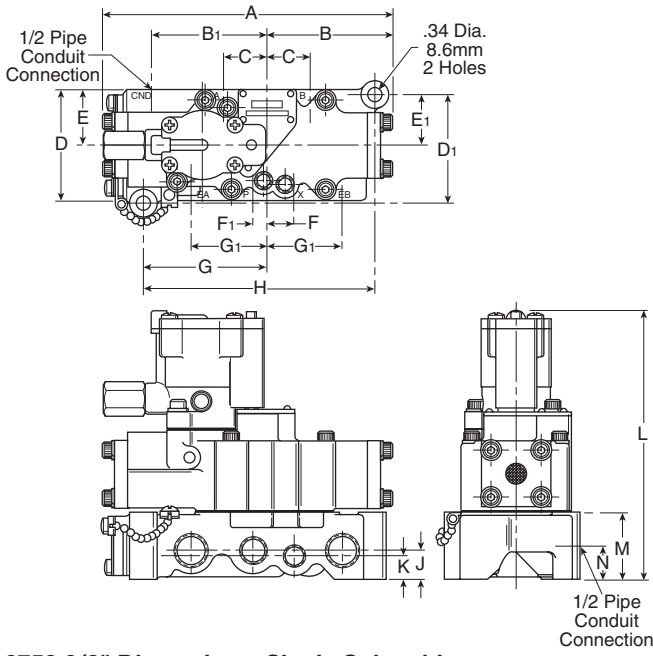

L6753 3/8" Dimensions, Single Solenoid

A	B	B ₁	C	D	D ₁	E	E ₁	F
7.56 (192)	3.32 (84.3)	2.94 (74.7)	1.12 (28.4)	2.88 (73.2)	2.84 (72.1)	1.44 (36.6)	1.34 (34)	.75 (19.1)
F ₁	G	G ₁	H	J	K	L	M	N
.38 (9.7)	3.16 (80.3)	2.00 (50.8)	6.03 (153.2)	.75 (19.1)	.62 (15.7)	6.93 (176)	1.75 (44.5)	1.00 (25.4)

Inches (mm)

L6758 1" Dimensions, Single Solenoid

A	B	B ₁	C	D	D ₁	E	E ₁	F
10.46 (265.7)	4.75 (120.6)	2.94 (74.7)	3.38 (85.8)	4.56 (115.8)	4.28 (108.7)	2.28 (57.9)	2.44 (62)	2.45 (62.2)
F ₁	G	H	J	K	L	M	N	
2.46 (62.5)	3.81 (96.8)	7.62 (193.5)	1.31 (33.3)	.59 (15)	8.74 (222)	2.09 (53.1)	1.22 (31)	

Inches (mm)

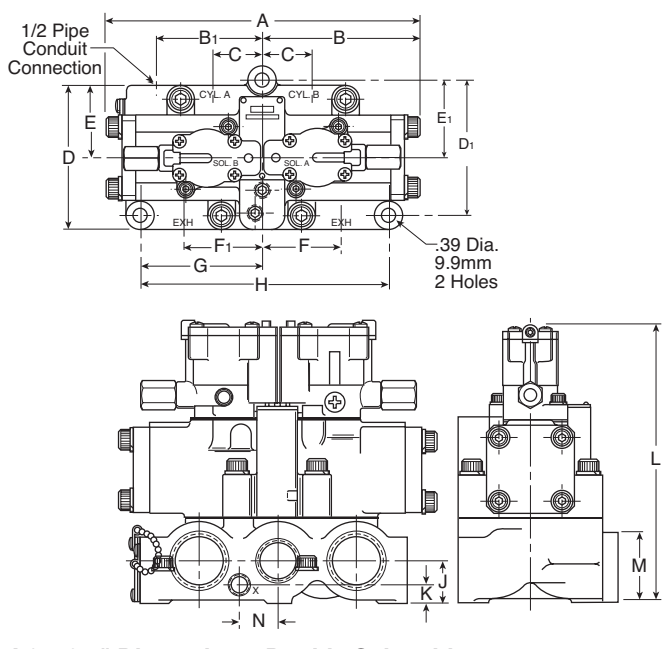
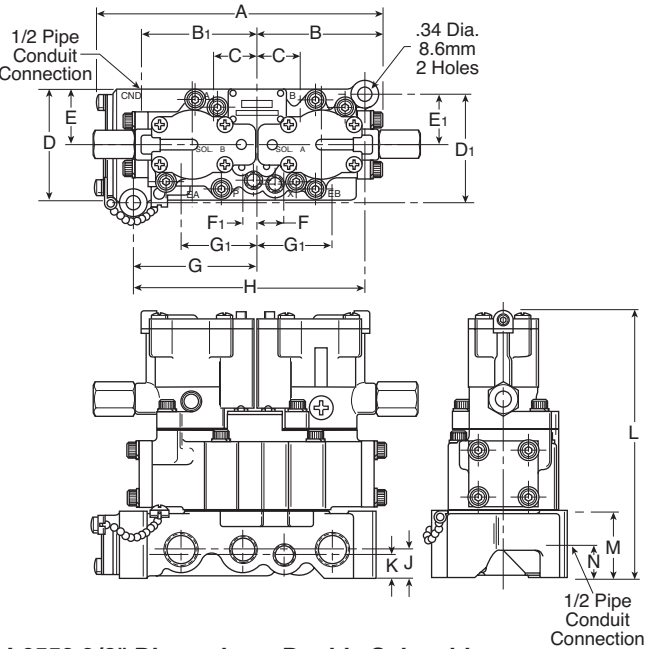

L6553 3/8" Dimensions, Double Solenoid

A	B	B ₁	C	D	D ₁	E	E ₁	F
7.38 (187.5)	3.32 (84.3)	2.94 (74.7)	1.12 (28.4)	2.88 (73.2)	2.84 (72.1)	1.44 (36.6)	1.34 (34)	.75 (19.1)
F ₁	G	G ₁	H	J	K	L	M	N
.38 (9.7)	3.16 (80.3)	2.00 (50.8)	6.03 (153.2)	.75 (19.1)	.62 (15.7)	6.93 (176)	1.75 (44.5)	1.00 (25.4)

Inches (mm)

L6558 1" Dimensions, Double Solenoid

A	B	B ₁	C	D	D ₁	E	E ₁	F
9.50 (241.3)	4.75 (120.6)	3.38 (85.8)	1.53 (38.9)	4.56 (115.8)	4.28 (108.7)	2.28 (57.9)	2.44 (62)	2.45 (62.2)
F ₁	G	H	J	K	L	M	N	
2.46 (62.5)	3.81 (96.8)	7.62 (193.5)	1.31 (33.3)	.59 (15)	8.74 (222)	2.09 (53.1)	1.22 (31)	

Inches (mm)

D
 Subbase & Manual Valves
 H Series Micro
 Moduteflex Series
 H Series ISO
 Network Connectivity
 DX ISOMAX Series
 Valvair II Series



For inventory, lead times, and kit lookup, visit www.pdnplu.com

D290

Parker Hannifin Corporation
 Pneumatic Division
 Richland, Michigan
www.parker.com/pneumatics

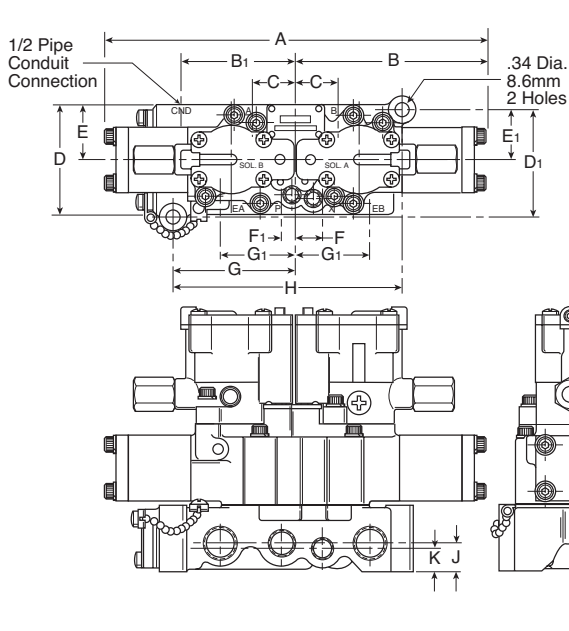

L6653 3/8" Dimensions, 3-Position, Double Solenoid

A	B	B ₁	C	D	D ₁	E	E ₁	F
9.64 (244.8)	4.82 (122.4)	2.94 (74.7)	1.12 (28.4)	2.88 (73.2)	2.84 (72.1)	1.44 (36.6)	1.34 (34)	.75 (19.1)
F ₁	G	G ₁	H	J	K	L	M	
.38 (9.7)	3.16 (80.3)	2.00 (50.8)	6.03 (153.2)	.75 (19.1)	.62 (15.7)	6.93 (176)	1.00 (25.4)	

Inches (mm)

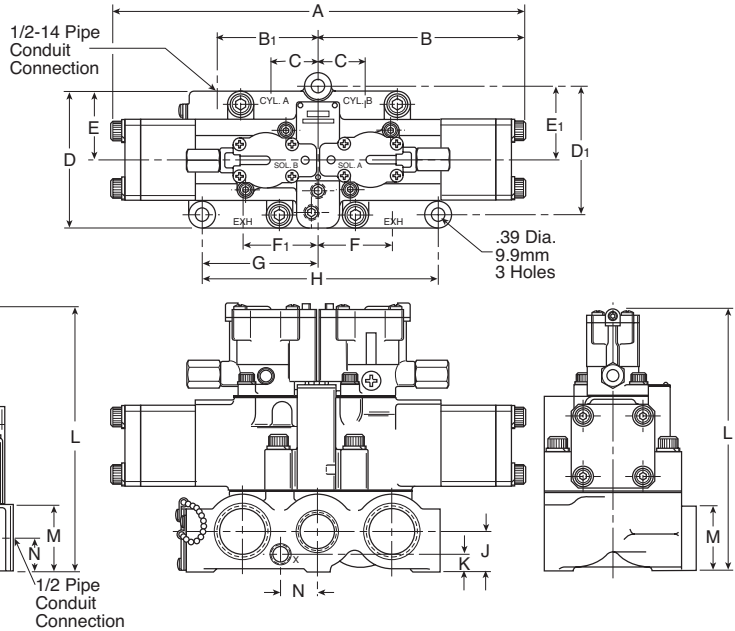

L6658 1" Dimensions, 3-Position, Double Solenoid

A	B	B ₁	C	D	D ₁	E	E ₁	F
13.62 (345.9)	6.81 (173)	3.38 (85.8)	1.53 (38.9)	4.56 (115.8)	4.28 (108.7)	2.28 (57.9)	2.44 (62)	2.45 (62.2)
F ₁	G	H	J	K	L	M	N	
2.46 (62.5)	3.81 (96.8)	7.62 (193.5)	1.31 (33.3)	.59 (15)	8.74 (222)	2.09 (53.1)	1.22 (31)	

Inches (mm)

D

Subbase & Manual Valves

H Series Micro

Moduflex Series

H Series ISO

Network Connectivity

DX ISOMAX Series

Valvair II Series

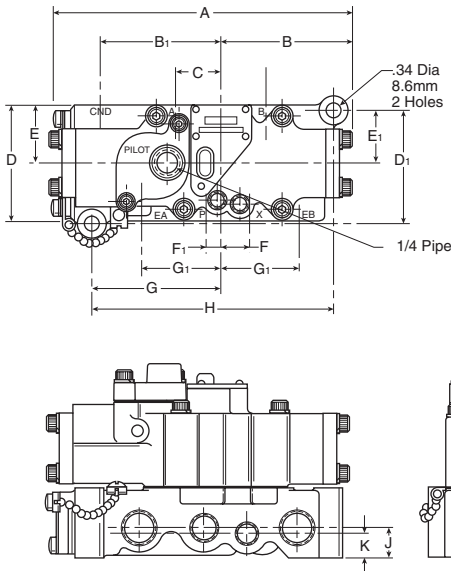

L6743 3/8" Dimensions, Single Remote Pilot

A	B	B ₁	C	D	D ₁	E	E ₁	F
7.56 (192)	3.32 (84.3)	2.94 (74.7)	1.12 (28.4)	2.88 (73.2)	2.84 (72.1)	1.44 (36.6)	1.34 (34)	.75 (19.1)
F ₁	G	G ₁	H	J	K	L	M	
.38 (9.7)	3.16 (80.3)	2.00 (50.8)	6.03 (153.2)	.75 (19.1)	.62 (15.7)	4.76 (120.9)	1.75 (44.5)	

Inches (mm)

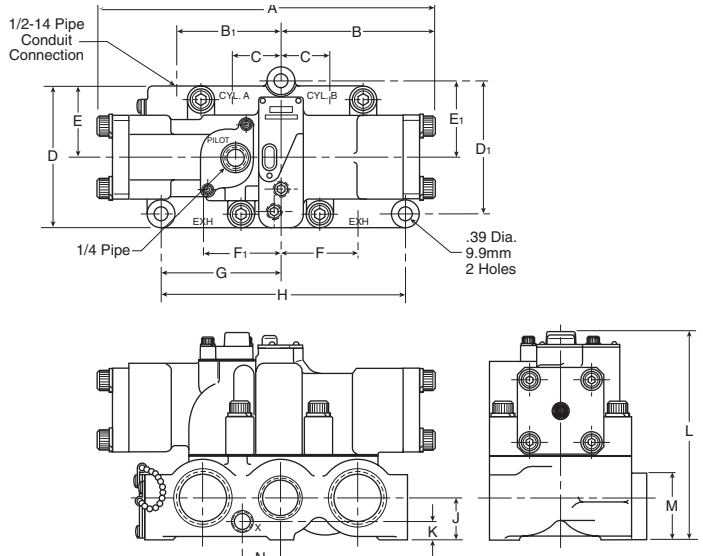

L6748 1" Dimensions, Single Remote Pilot

A	B	B ₁	C	D	D ₁	E	E ₁	F
10.46 (265.7)	4.75 (120.6)	3.38 (85.8)	1.53 (38.9)	4.56 (115.8)	4.28 (108.7)	2.28 (57.9)	2.44 (62)	2.45 (62.2)
F ₁	G	H	J	K	L	M	N	
2.46 (62.5)	3.81 (96.8)	7.62 (193.5)	1.31 (33.3)	.59 (15)	6.57 (166.9)	2.09 (53.1)	1.22 (31)	

Inches (mm)



For inventory, lead times, and kit lookup, visit www.pdnplu.com

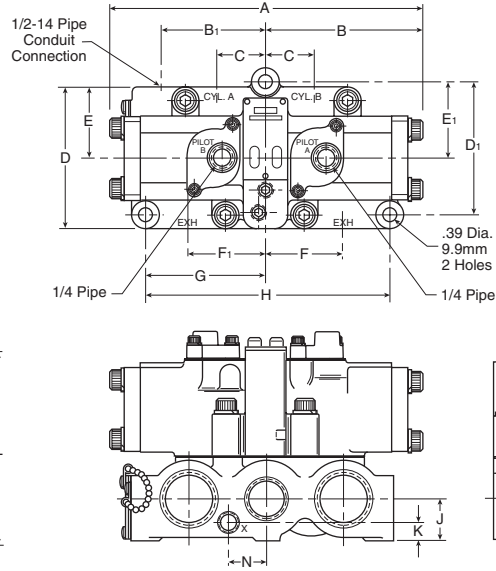
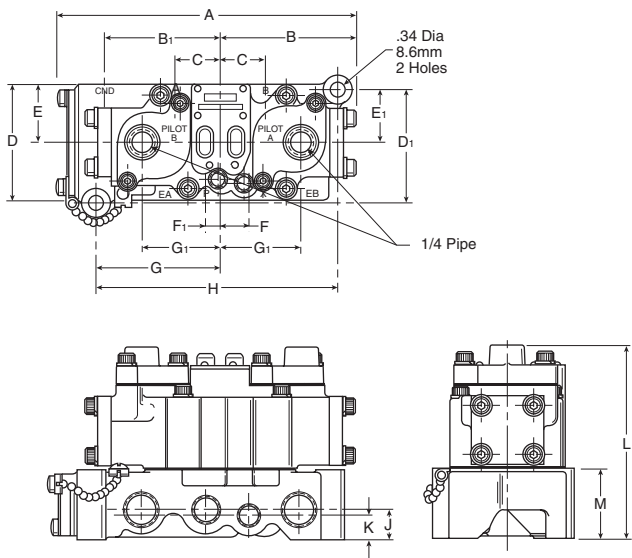

L6543 3/8" Dimensions, Double Remote Pilot

A	B	B ₁	C	D	D ₁	E	E ₁	F
7.56 (192)	3.32 (84.3)	2.94 (74.7)	1.12 (28.4)	2.88 (73.2)	2.84 (72.1)	1.44 (36.6)	1.34 (34)	.75 (19.1)
F ₁	G	G ₁	H	J	K	L	M	
.38 (9.7)	3.16 (80.3)	2.00 (50.8)	6.03 (153.2)	.75 (19.1)	.62 (15.7)	4.76 (120.9)	1.75 (44.5)	

Inches (mm)

L6548 1" Dimensions, Double Remote Pilot

A	B	B ₁	C	D	D ₁	E	E ₁	F
9.50 (241.3)	4.75 (120.6)	3.38 (85.8)	1.53 (38.9)	4.56 (115.8)	4.28 (108.7)	2.28 (57.9)	2.44 (62)	2.45 (62.2)
F ₁	G	H	J	K	L	M	N	
2.46 (62.5)	3.81 (96.8)	7.62 (193.5)	1.31 (33.3)	.59 (15)	6.57 (166.9)	2.09 (53.1)	1.22 (31)	

Inches (mm)

D
Subbase & Manual Valves
H Series Micro
Modulflex Series
H Series ISO
Network Connectivity
DX ISOMAX Series
Valvair II Series

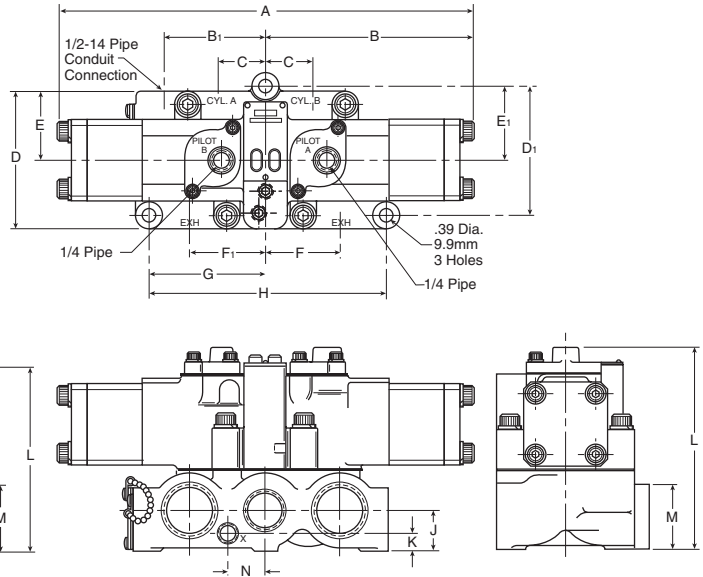
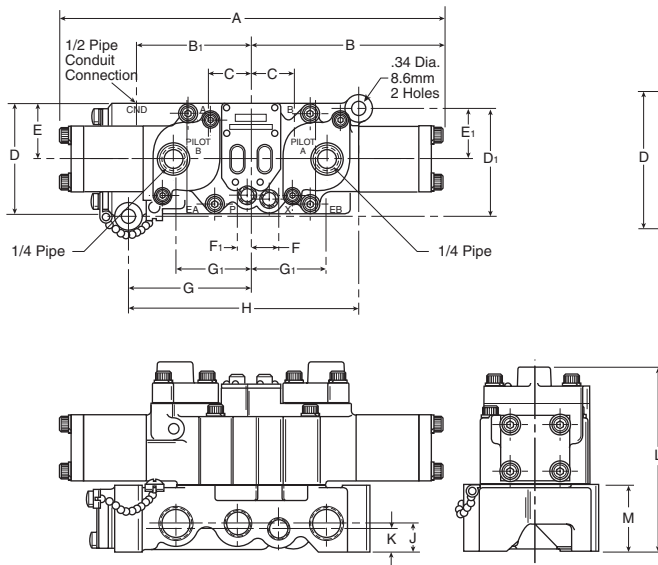

L6643 3/8" Dimensions, 3-Position, Remote Pilot

A	B	B ₁	C	D	D ₁	E	E ₁	F
9.64 (244.8)	4.82 (122.4)	2.94 (74.7)	1.12 (28.4)	2.88 (73.2)	2.84 (72.1)	1.44 (36.6)	1.34 (34)	.75 (19.1)
F ₁	G	G ₁	H	J	K	L	M	
.38 (9.7)	3.16 (80.3)	2.00 (50.8)	6.03 (153.2)	.75 (19.1)	.62 (15.7)	4.76 (120.9)	1.75 (44.5)	

Inches (mm)

L6648 1" Dimensions, 3-Position, Remote Pilot

A	B	B ₁	C	D	D ₁	E	E ₁	F
13.62 (345.9)	6.81 (173)	3.38 (85.8)	1.53 (38.9)	4.56 (115.8)	4.28 (108.7)	2.28 (57.9)	2.44 (62)	2.45 (62.2)
F ₁	G	H	J	K	L	M	N	
2.46 (62.5)	3.81 (96.8)	7.62 (193.5)	1.31 (33.3)	.59 (15)	6.57 (166.8)	2.09 (53.1)	1.22 (31)	

Inches (mm)



For inventory, lead times, and kit lookup, visit www.pdnplu.com

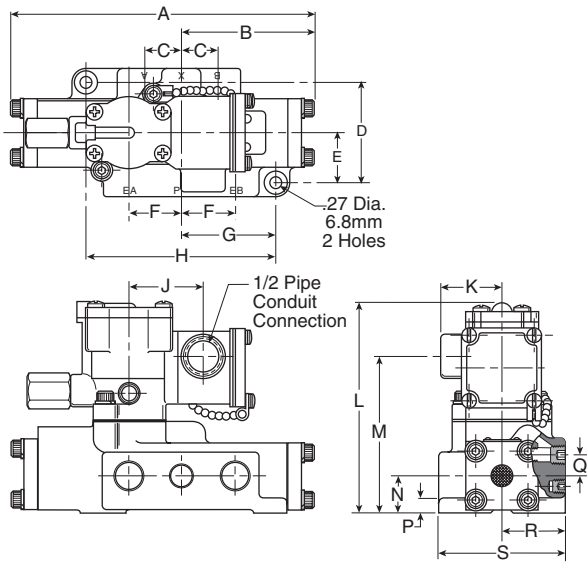

L705 3/8" Dimensions, Single Solenoid

A	B	C	D	E	F	G	H	J
7.56	3.32	.90	2.56	1.28	1.33	2.34	4.69	1.82
(192)	(84.3)	(22.9)	(65)	(32.5)	(33.8)	(59.4)	(119.1)	(46.2)
K	L	M	N	P	Q	R	S	
1.50	5.35	3.91	.94	.38	.53	1.62	3.25	
(38.1)	(135.9)	(99.3)	(23.9)	(9.7)	(13.5)	(41.1)	(82.6)	

Inches (mm)

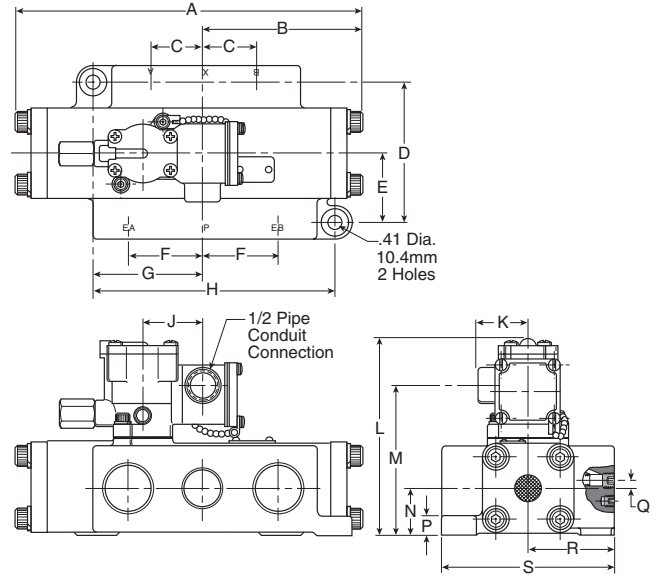

L705 1" Dimensions, Single Solenoid

A	B	C	D	E	F	G	H	J
10.46	4.75	1.62	4.25	2.12	2.19	3.44	7.44	1.82
(265.7)	(120.6)	(41.1)	(108)	(53.8)	(55.6)	(87.4)	(189)	(46.2)
K	L	M	N	P	Q	R	S	
1.50	6.44	4.95	1.50	.69	.20	2.62	5.25	
(38.1)	(163.6)	(125.7)	(38.1)	(17.5)	(5.1)	(66.5)	(133.4)	

Inches (mm)

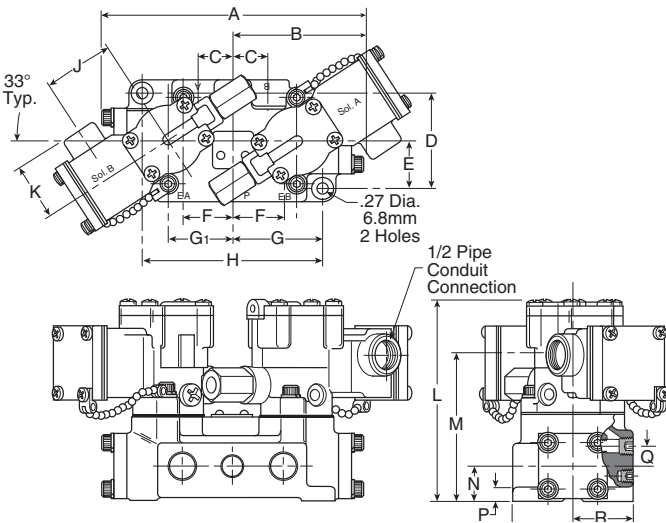

L685 3/8" Dimensions, Double Solenoid

A	B	C	D	E	F	G	G ₁	H
7.56	3.32	.90	2.56	1.28	1.33	2.34	1.66	4.69
(192)	(84.3)	(22.9)	(65)	(32.5)	(33.8)	(59.4)	(42.4)	(119.1)
J	K	L	M	N	P	Q	R	S
1.82	1.50	5.35	3.91	.94	.38	.53	1.62	3.25
(46.2)	(38.1)	(135.9)	(99.3)	(23.9)	(9.7)	(13.5)	(41.1)	(82.6)

Inches (mm)

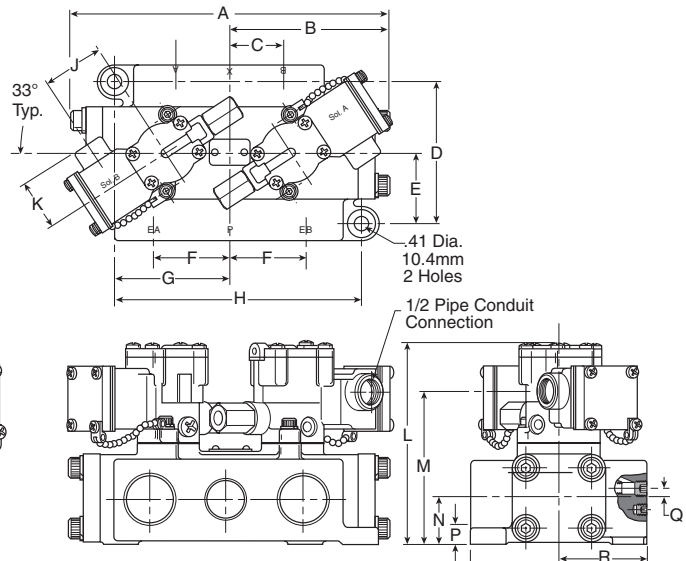

L685 1" Dimensions, Double Solenoid

A	B	C	D	E	F	G	H	J
9.50	4.75	1.62	4.25	2.12	2.19	3.44	7.44	1.82
(241.3)	(120.6)	(41.1)	(108)	(53.8)	(55.6)	(87.4)	(189)	(46.2)
K	L	M	N	P	Q	R	S	
1.50	6.44	4.95	1.50	.69	.20	2.62	5.25	
(38.1)	(163.6)	(125.7)	(38.1)	(17.5)	(5.1)	(66.5)	(133.4)	

Inches (mm)



For inventory, lead times, and kit lookup, visit www.pdnplu.com

D293

Parker Hannifin Corporation
 Pneumatic Division
 Richland, Michigan
www.parker.com/pneumatics

D

Subbase & Manual Valves

H Series Micro

Modulflex Series

H Series ISO

Network Connectivity

DX ISOMAX Series

Valvair II Series

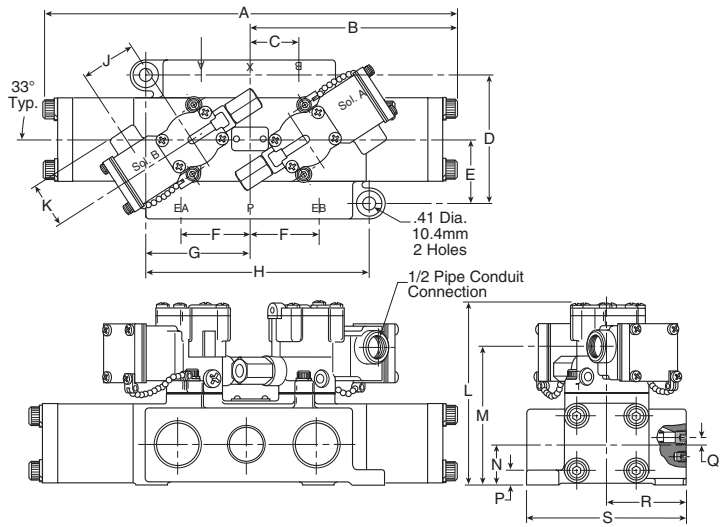
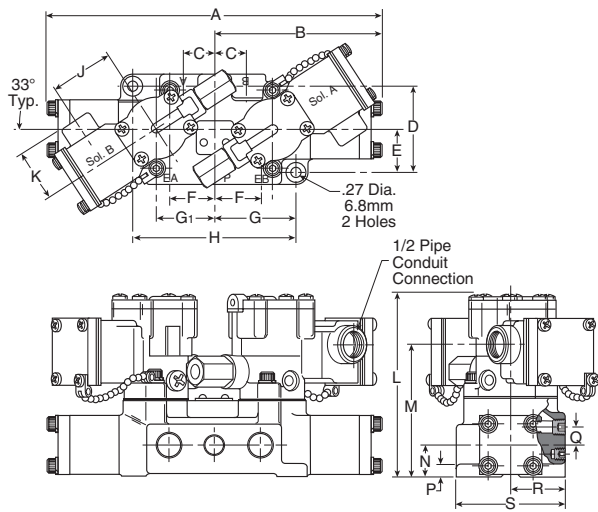

L695 3/8" Dimensions, 3-Position Double Solenoid

A	B	C	D	E	F	G	G ₁	H
9.64	4.82	.90	2.56	1.28	1.33	2.34	1.66	4.69
(244.8)	(122.4)	(22.9)	(65)	(32.5)	(33.8)	(59.4)	(42.4)	(119.1)
J	K	L	M	N	P	Q	R	S
1.82	1.50	5.35	3.91	.94	.38	.53	1.62	3.25
(46.2)	(38.1)	(135.9)	(99.3)	(23.9)	(9.7)	(13.5)	(41.1)	(82.6)

Inches (mm)

L695 1" Dimensions, 3-Position, Double Solenoid

A	B	C	D	E	F	G	H	J
13.63	6.81	1.62	4.25	2.12	2.19	3.44	7.44	1.82
(346.2)	(173)	(41.1)	(108)	(53.8)	(55.6)	(87.4)	(189)	(46.2)
K	L	M	N	P	Q	R	S	
1.50	6.44	4.95	1.50	.69	.20	2.62	5.25	
(38.1)	(163.6)	(125.7)	(38.1)	(17.5)	(5.1)	(66.5)	(133.4)	

Inches (mm)

D
Subbase & Manual Valves
H Series Micro
Modulflex Series
H Series ISO
Network Connectivity
DX ISOMAX Series
Valvair II Series

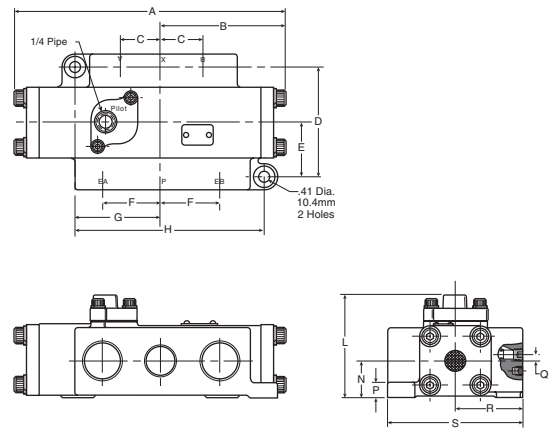
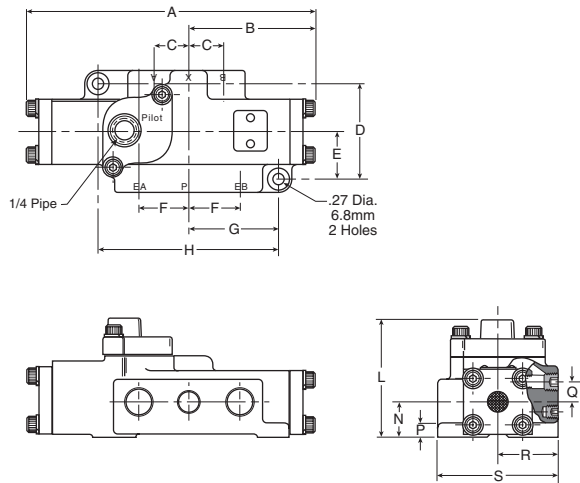

L704 3/8" Dimensions, Single Remote Pilot

A	B	C	D	E	F	G	H	L
7.56	3.32	.90	2.56	1.28	1.33	2.34	4.69	3.18
(192)	(84.3)	(22.9)	(65)	(32.5)	(33.8)	(59.4)	(119.1)	(80.8)
N	P	Q	R	S				
.94	.38	.53	1.62	3.25				
(23.9)	(9.7)	(13.5)	(41.1)	(82.6)				

Inches (mm)

L704 1" Dimensions, Single Remote Pilot

A	B	C	D	E	F	G	H	L
10.46	4.75	1.62	4.25	2.12	2.19	3.44	7.44	4.09
(265.7)	(120.6)	(41.1)	(108)	(53.8)	(55.6)	(87.4)	(189)	(103.9)
N	P	Q	R	S				
1.50	.69	.20	2.62	5.25				
(38.1)	(17.5)	(5.1)	(66.5)	(133.4)				

Inches (mm)



For inventory, lead times, and kit lookup, visit www.pdnplu.com

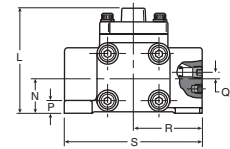
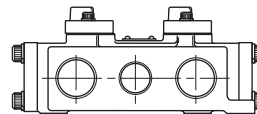
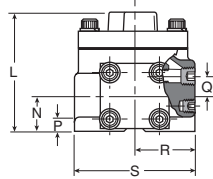
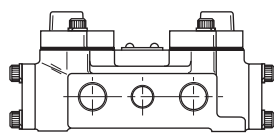
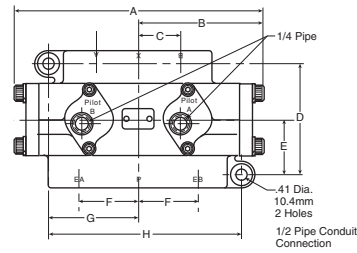
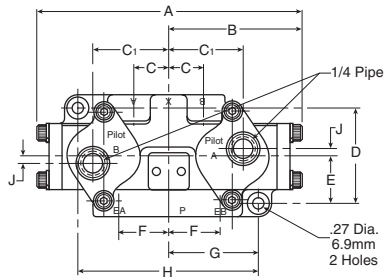

L684 3/8" Dimensions, Double Remote Pilot

A	B	C	C ₁	D	E	F	G	H
6.64	3.32	.90	1.98	2.56	1.28	1.33	2.34	4.69
(168.7)	(84.3)	(22.9)	(50.3)	(65)	(32.5)	(33.8)	(59.4)	(119.1)
J	L	N	P	Q	R	S		
.22	3.05	.94	.38	.53	1.62	3.25		
(5.6)	(77.5)	(23.9)	(9.7)	(13.5)	(41.1)	(82.6)		

Inches (mm)

L684 1" Dimensions, Double Remote Pilot

A	B	C	D	E	F	G	H	L
9.50	4.75	1.62	4.25	2.12	2.19	3.44	7.44	4.09
(241.3)	(120.6)	(41.1)	(108)	(53.8)	(55.6)	(87.4)	(189)	(103.9)
N	P	Q	R	S				
1.50	.69	.20	2.62	5.25				
(38.1)	(17.5)	(5.1)	(66.5)	(133.4)				

Inches (mm)

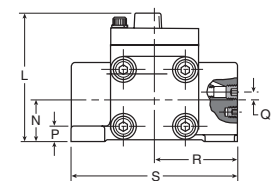
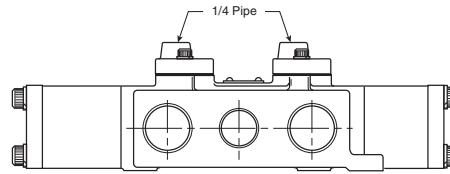
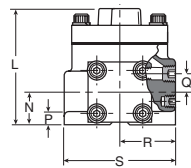
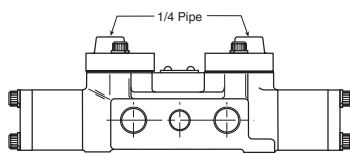
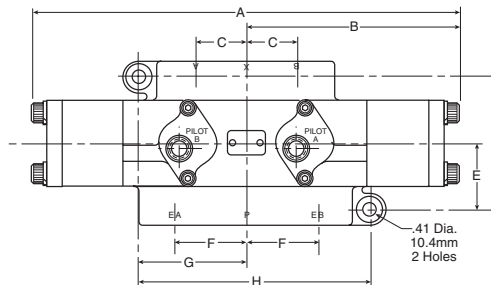
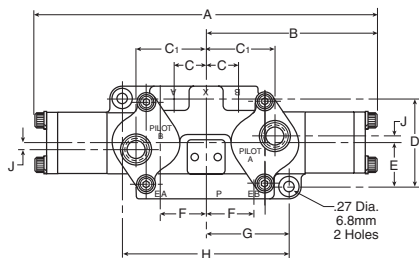

L694 3/8" Dimensions, 3-Position, Double Remote Pilot

A	B	C	C ₁	D	E	F	G	H
9.64	4.82	.90	1.98	2.56	1.28	1.33	2.34	4.69
(244.8)	(122.4)	(22.9)	(50.3)	(65)	(32.5)	(33.8)	(59.4)	(119.1)
J	L	N	P	Q	R	S		
.22	3.05	.94	.38	.53	1.62	3.25		
(5.6)	(77.5)	(23.9)	(9.7)	(13.5)	(41.1)	(82.6)		

Inches (mm)

L694 1" Dimensions, 3-Position, Double Remote Pilot

A	B	C	D	E	F	G	H	L
13.63	6.81	1.62	4.25	2.12	2.19	3.44	7.44	6.44
(346.2)	(173)	(41.1)	(108)	(53.8)	(55.6)	(87.4)	(189)	(163.6)
N	P	Q	R	S				
1.50	.69	.20	2.62	5.25				
(38.1)	(17.5)	(5.1)	(66.5)	(133.4)				

Inches (mm)



For inventory, lead times, and kit lookup, visit www.pdnplu.com

D295

Parker Hannifin Corporation
 Pneumatic Division
 Richland, Michigan
www.parker.com/pneumatics

D

Subbase & Manual Valves

H Series Micro

Modulflex Series

H Series ISO

Network Connectivity

DX ISOMAX Series

Valvair II Series

Plug-in Manifold, 3/8" Basic

- K142230Cylinder ports 3/8" NPTF
- K142231Cylinder ports 1/2" NPTF
- K142270Cylinder ports 3/4" NPTF
- Exhaust port..... 1" NPTF
- Inlet port..... 1" NPTF
- Conduit port..... 1-1/4" NPTF

Note: Manifold assemblies include mounting hardware.

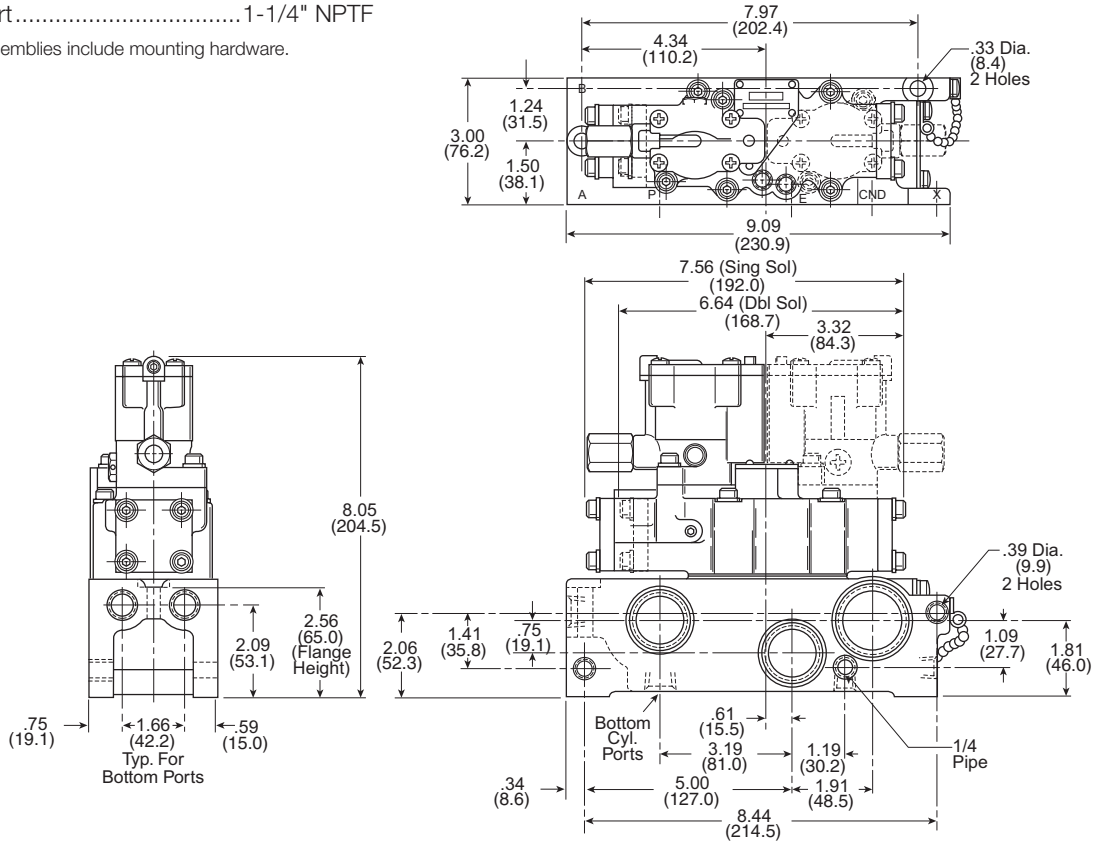

D	Subbase & Manual Valves
H Series Micro	Modulflex Series
H Series ISO	Network Connectivity
DX ISOMAX Series	Valvair II Series



For inventory, lead times, and kit lookup, visit www.pdnplu.com

D296

Parker Hannifin Corporation
 Pneumatic Division
 Richland, Michigan
www.parker.com/pneumatics

Pneumatic Valve Products
Manual / Mechanical Series



Directair 2 / Directair 4 Series

Features	E2
Common Part Numbers / Ordering Information	E3-E6
Technical Data	E7-E8
Dimensional Data	E9-E13



Viking Xtreme Lever Series

Features	E14
Common Part Numbers / Ordering Information	E15-E16
Accessories	E17
Dimensional Data	E17a-E20



42 Lever / Pedal Series

Features	E19
Common Part Numbers / Ordering Information	E20
Dimensional Data	E21



MO Series

Features	E22
Common Part Numbers / Ordering Information	E23-E25
Accessories	E26
Technical Data	E27-E34
Dimensional Data	E35-E49



Safety

Lockout Valves	E50-E57
Two Hand Control	E58-E59

Brass Poppet / Sliding Seal

PL / VL Series	E60-E61
HV Series	E62
Sliding Seal Valves	E63
Button Operated Valves	E64
Hand / Cam Operated Valves	E65
Bleed Valves	E66



Control Panel Products

Features	E67
Accessories	E68-E71
Technical / Dimensional Data	E72-E74



Sensing Products, Limit Switches

Features	E75
Technical / Dimensional Data	E79-E83



Features

Directair 2 & 4 Series

Directair 2, 1/8" valves
Poppet style – .17 Cv

- Economical
- 3-way normally closed function

Directair 2, 1/8" valves
Packed bore style – .20 Cv

- Stainless steel spool
- Fluorocarbon o-rings
- 3-way & 4-way

Directair 4, 1/4" valves
Packed bore style – .83 Cv

- Stainless steel spool
- Fluorocarbon o-rings
- 3-way & 4-way

Material specifications

Body and operator housings	Aluminum extrusion
Bushings and pilot piston	Brass
Dynamic seals	Fluorocarbon
Operator o-rings, u-cups	Buna (nitrile)
Poppet ball	Nylon
Spacers - Directair 2	Aluminum
Spacers - Directair 4	Zinc die cast
Spool	Stainless steel

Flow Rating (Cv)

Flow Path	Direct Pipe Spool, 1/8" Ports	Direct Pipe Poppet, 1/8" Ports
Directair 2		
1 → 2	.199	.125
1 → 4	.191	—
2 → 3	.192	.215
4 → 5	.212	—
Avg.	.199	N/A
Directair 4		
1 → 2	.82	.64
1 → 4	.84	.66
2 → 3	.84	.63
4 → 5	.83	.63
Avg.	.83	.64

 Most popular.

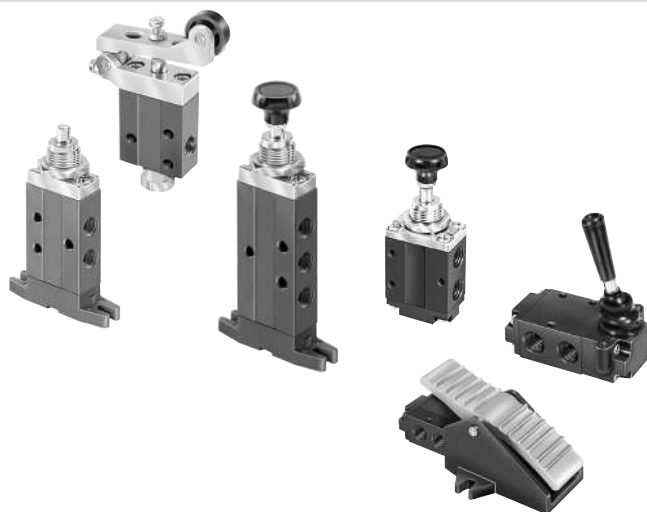

Operating information

Operating pressure	Vacuum to 150 PSI (28 inHg to 1035 kPa)*
Temperature range	32°F to 175°F (0°C to 80°C)

* Poppet valves cannot be used for vacuum. Minimum operating pressure = 0 PSIG.

CAUTION:
If it is possible that the ambient temperature may fall below freezing, the medium must be moisture free to prevent internal damage or unpredictable behavior.

Lubrication

For maximum service life use clean, lubricated air. Valves are shipped pre-lubricated and can be operated without additional lubrication with reduced service life.

Suggested Lubricant

F442 Oil

Mechanically operated actuating forces in lbs. 1/4" Directair 4 valves

	2-Position Spring Return	2-Position Manual Return	3-Position Spring Return	3-Position Manual Return
Button Actuator	13.0	2.0	13.0	N/A
Roller Actuator	13.0	N/A	N/A	N/A
Lever Actuator	4.0	2.0	4.0	2.5

Notes: N/A = Not Applicable
All valves are at 100 PSIG inlet pressure to the valve.

Directair 2 & 4 Series

Viking Xtreme Lever Series

4:2 Lever / Pedal Series

M0 Series

Safety



Manual / Mechanical Valves

Brass Poppet / Sliding Seal











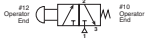
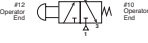

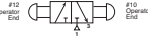

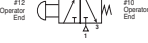

Control Panel Products

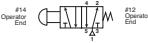
Sensing

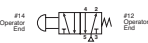
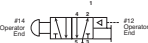

For inventory, lead times, and kit lookup, visit www.pdnplu.com

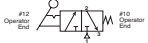
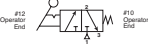
3-Way & 4-Way Valves

	Symbol	Port Size	Cv	Description	Valve Type	Part Number	
		1/8"	.17	3-Way, Spring Return	Poppet	404411000	
		1/8"	.20	3-Way, Spring Return	Spool	414411000	
		1/8"	.20	3-Way, Spring Return, Foot Mounted	Spool	414421000	
		1/8"	.20	3-Way, Pilot Return	Spool	414451000	
		1/8"	.20	3-Way, Manual Return	Spool	414931000	
		1/8"	.20	3-Way, Manual Return, Foot Mounted	Spool	414941000	
		1/8"	.20	3-Way, Manual Or Pilot Return	Spool	414951000	
		1/4"	.83	3-Way, Spring Return	Spool	524411000	
		1/4"	.83	3-Way, Pilot Return	Spool	524451000	
		1/4"	.83	3-Way, Manual Return	Spool	524431000	
			1/8"	.20	4-Way, Spring Return	Spool	410411000
			1/8"	.20	4-Way, Spring Return, Foot Mounted	Spool	410421000
		1/8"	.20	4-Way, Pilot Return	Spool	410451000	
		1/8"	.20	4-Way, Manual Return	Spool	410931000	
		1/8"	.20	4-Way, Manual Return, Foot Mounted	Spool	410941000	
		1/8"	.20	4-Way, Manual Or Pilot Return	Spool	410951000	
		1/4"	.83	4-Way, Spring Return	Spool	520411000	
		1/4"	.83	4-Way, Pilot Return	Spool	520451000	
		1/4"	.83	4-Way, Manual Return	Spool	520431000	
			1/8"	.17	3-Way, Spring Return	Poppet	404811000
		1/8"	.20	3-Way, Spring Return	Spool	414811000	
		1/8"	.20	3-Way, Spring Return, Foot Mounted	Spool	414821000	
		1/8"	.20	4-Way, Spring Return	Spool	410811000	
		1/8"	.20	4-Way, Spring Return, Foot Mounted	Spool	410821000	

Directair 2 & 4 Series
 Viking Xtreme Lever Series
 42 Lever / Pedal Series
 M0 Series
 Safety
 Manual / Mechanical Valves
 Brass Poppet / Sliding Seal
 Control Panel Products
 Sensing



For inventory, lead times, and kit lookup, visit www.pdnplu.com

3-Way & 4-Way Valves

	Symbol	Port Size	Cv	Description	Valve Type	Part Number
Lever Operated		1/4"	.83	3-Way, Spring Return	Spool	524811000
		1/4"	.83	3-Way, Manual Return	Spool	524831000
		1/4"	.83	3-Way, 3-Position Detented, All Ports Blocked	Spool	523831000
		1/4"	.83	4-Way, Spring Return	Spool	520811000
		1/4"	.83	4-Way, Manual Return	Spool	520831000
		1/4"	.83	4-Way, Spring Centered, Closed Center	Spool	521811000
		1/4"	.83	4-Way, Spring Centered, Pressure Center	Spool	522811000
		1/4"	.83	4-Way, Spring Centered, Exhaust Center	Spool	529811000
		1/4"	.83	4-Way, Detented, Closed Center	Spool	521831000
		1/4"	.83	4-Way, Detented, Pressure Center	Spool	522831000
	1/4"	.83	4-Way, Detented, Exhaust Center	Spool	529831000	
Roller Operated		1/8"	.20	3-Way, Spring Return	Poppet	404211000
		1/8"	.20	3-Way, Spring Return	Spool	414211000
		1/8"	.20	3-Way, Spring Return, Foot Mounted	Spool	414221000
		1/8"	.20	3-Way, Pilot Return	Spool	414251000
		1/8"	.20	4-Way, Spring Return	Spool	410211000
		1/8"	.20	4-Way, Spring Return, Foot Mounted	Spool	410221000
		1/8"	.20	4-Way, Pilot Return	Spool	410251000
		1/4"	.83	3-Way, Spring Return, Delrin Roller	Spool	524211000
		1/4"	.83	3-Way, Pilot Return, Delrin Roller	Spool	524251000
		1/4"	.83	3-Way, Spring Return, Steel Roller	Spool	524A11000
	1/4"	.83	3-Way, Pilot Return, Steel Roller	Spool	524A51000	
Roller Operated		1/4"	.83	4-Way, Spring Return, Delrin Roller	Spool	520211000
		1/4"	.83	4-Way Pilot Return, Delrin Roller	Spool	520251000
		1/4"	.83	4-Way, Spring Return, Steel Roller	Spool	520A11000
		1/4"	.83	4-Way, Pilot Return, Steel Roller	Spool	520A51000

Directair 2 & 4 Series

Viking Xtreme Lever Series

42 Lever / Pedal Series

M0 Series

Safety



Manual / Mechanical Valves

Brass Poppet / Sliding Seal













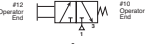
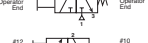

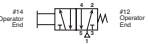
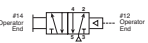



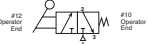
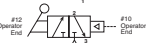
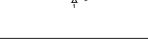
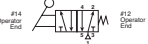



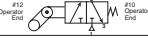
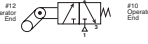
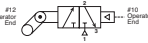

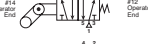
Control Panel Products

Sensing



For inventory, lead times, and kit lookup, visit www.pdnplu.com

3-Way & 4-Way Valves

	Symbol	Port Size	Cv	Description	Valve Type	Part Number	
Plunger Operated  		1/8"	.17	3-Way, Spring Return	Poppet	404111000	
		1/8"	.20	3-Way, Spring Return	Spool	414111000	
		1/8"	.20	3-Way, Spring Return, Foot Mounted	Spool	414121000	
		1/8"	.20	3-Way, Pilot Return	Spool	414151000	
		1/8"	.17	4-Way, Spring Return	Spool	410111000	
		1/8"	.20	4-Way, Spring Return, Foot Mounted	Spool	410121000	
		1/8"	.20	4-Way, Pilot Return	Spool	410151000	
	Hand Lever Operated  		1/8"	.17	3-Way, Spring Return	Poppet	404711000
			1/8"	.20	3-Way, Spring Return	Spool	414711000
		1/8"	.20	3-Way, Spring Return, Foot Mounted	Spool	414721000	
		1/8"	.20	3-Way, Pilot Return	Spool	414751000	
		1/8"	.20	4-Way, Spring Return	Spool	410711000	
		1/8"	.20	4-Way, Spring Return, Foot Mounted	Spool	410721000	
		1/8"	.20	4-Way, Pilot Return	Spool	410751000	
One Way Tripper Operated  			1/8"	.17	3-Way, Spring Return	Poppet	404311000
			1/8"	.20	3-Way, Spring Return	Spool	414311000
		1/8"	.20	3-Way, Spring Return, Foot Mounted	Spool	414321000	
		1/8"	.20	3-Way, Pilot Return	Spool	414351000	
		1/8"	.20	4-Way, Spring Return	Spool	414311000	
		1/8"	.20	4-Way, Spring Return, Foot Mounted	Spool	414321000	
		1/8"	.20	4-Way, Pilot Return	Spool	414351000	
	Pedal Operated 		1/4"	.83	3-Way, Spring Return	Spool	524711000
			1/4"	.83	3-Way, Pilot Return	Spool	524751000
		1/4"	.83	4-Way, Spring Return	Spool	520711000	
		1/4"	.83	4-Way, Pilot Return	Spool	520751000	
<p>CAUTION: <i>This valve shall not be used to actuate a punch press. Do not use this valve on punch presses or press brakes. See OSHA 1910.217.</i></p>							
Treadle Operated 		1/4"	.83	3-Way, Treadle Operated, Detented	Spool	524931000	
		1/4"	.83	4-Way, Treadle Operated, Detented	Spool	520931000	
<p>CAUTION: <i>This valve shall not be used to actuate a punch press. Do not use this valve on punch presses or press brakes. See OSHA 1910.217.</i></p>							

Directair 2 & 4 Series
Viking Xtreme Lever Series
42 Lever / Pedal Series
M0 Series
Safety
E
Manual / Mechanical Valves
Brass Poppet / Sliding Seal
Control Panel Products
Sensing



For inventory, lead times, and kit lookup, visit www.pdnplu.com

Ordering Information

Directair 2

41 0 1 1 1 000

Basic Series	
1/8" Port Poppet Valve	40*
1/8" Port Spool Valve	41

* Only available in Spring Return.

Manual / Mechanical	
000	Standard

Type	
4-Way, 2-Position Valve	0*
3-Way, 2-Position	4

* N/A with Basic Series 40.

Mounting	
1	Direct Pipe Ported, NPT
K	Direct Pipe Ported, BSPP

Actuation	
Plunger	1
Roller - Delrin	2
One-Way Tripper	3
Button - Spring Return	4
Hand Lever	7
Toggle	8
Button - Push-Pull	9*

* N/A with Basic Series 40.

Return	
1 [†]	Spring
2 [†]	Spring w/ Foot Mount
3 [†]	None (Manual Return)
4 [†]	None (Manual Return w/ Foot Mount)
5 [†]	Remote Pilot Return

* Available only with Actuation 9.

[†] N/A with Actuation 8.

Directair 4

52 0 8 1 1 000

Basic Series	
1/4" Port Spool Valve	52

Manual / Mechanical	
000	Standard

Type	
4-Way, 2-Position Valve	0
4-Way, 3-Position, Closed Center	1*
4-Way, 3-Position, Pressure Center	2*
3-Way, 3-Position, Closed Center	3*
3-Way, 2-Position, Normally Closed	4
3-Way, 2-Position, Normally Open	6
4-Way, 3-Position, Exhaust Center	9*

* Only Available with Actuation 8 Lever.

Mounting	
1	Direct Pipe Ported, NPT
L	Direct Pipe Ported, BSPP

Return	
1 ^{††}	Spring
3 [†]	None (Manual Return)
5 [†]	Remote Pilot Return

* N/A with Actuation 8 & 9.

[†] N/A with Actuation 2, 7 or A.

^{††} N/A with Actuation 9.

Actuation	
Roller - Delrin	2
Button	4
Pedal	7
Lever	8
Treadle	9
Roller - Metal	A



For inventory, lead times, and kit lookup, visit www.pdnplu.com

Service Kits – 1/8 Port Size Valves (DA2)

①	Spool Valve Seal Kit (3 & 4-way, direct pipe ported)	410008000
②	Poppet Valve Seal Kit	404118000
③	Body Service Kit	410008005

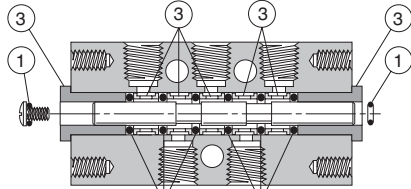

4-Way Spool

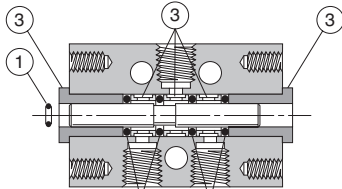

3-Way Spool

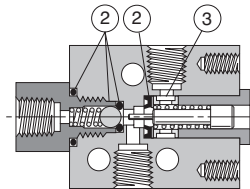

3-Way Poppet

Panel Mounting Kit – No. 520838004

Available for panel mounting direct pipe ported, lever operated 1/4" Directair 4 Series valves only. Kit includes a flange and two screws.

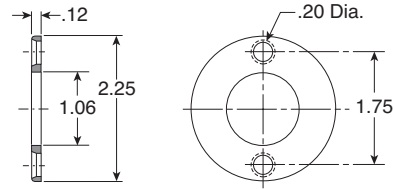

Pedal Guard Kit – No. 520718001

Pedal guard meets safety requirements for foot operated valves by protecting pedal from accidental tripping from all angles. Guard is constructed of lightweight aluminum casting for strength and durability. Bolts quickly into place with only three screws without special valve mounting. One model fits any pedal (not treadle) operated 1/4" Directair 4 Series valve.



CAUTION:

*This valve shall not be used to actuate a punch press.
 Do not use this valve on punch presses or press brakes.
 See OSHA 1910.217.*

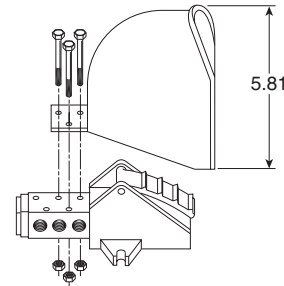

Service Kits – 1/4 Port Size Valves (DA4)

●	Valve Seal Kit (Contains all soft seals found in 3 & 4-way bodies and all actuator styles.)	520008050
	All fluorocarbon	520008500
■	Body Service Kit (Contains bushing, springs, retainers and shell from 2 & 3-position, 3 & 4-way bodies.)	520018005

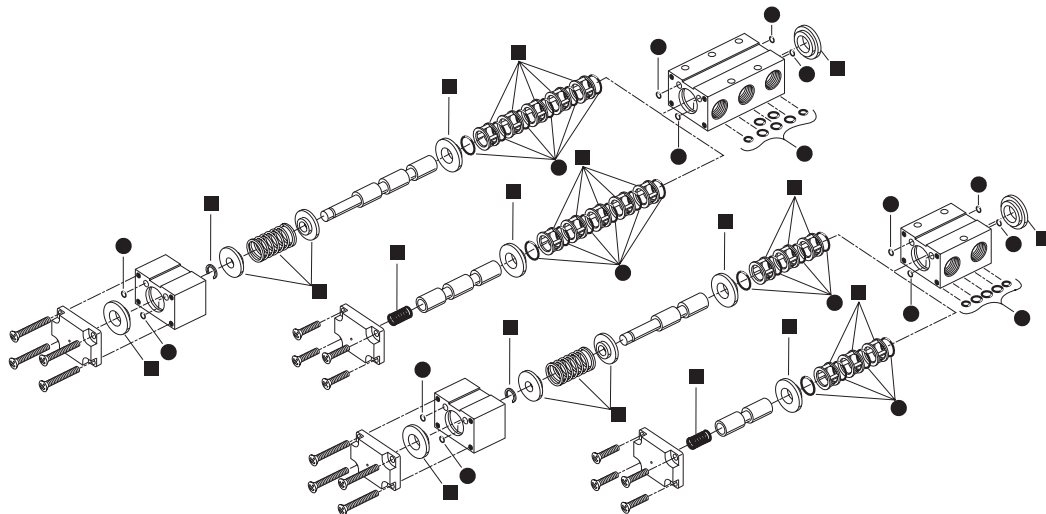

Directair 2 & 4 Series	Viking Xtreme Lever Series	42 Lever / Pedal Series	MO Series	Safety		Manual / Mechanical Valves	Brass Poppet / Sliding Seal	Control Panel Products	Sensing
------------------------	----------------------------	-------------------------	-----------	--------	--	----------------------------	-----------------------------	------------------------	---------

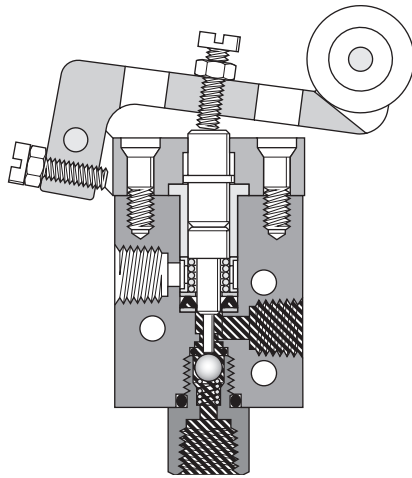

Roller Operated Poppet



Button Operated

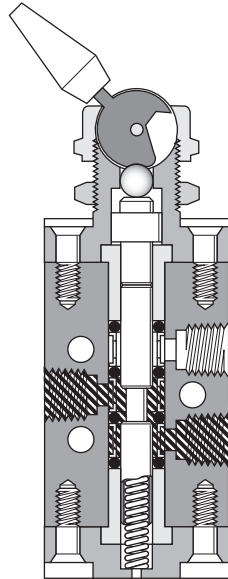

Toggle Operated Spool



Lever Operated



Treadle Operated

 Pressure  Exhaust



For inventory, lead times, and kit lookup, visit www.pdnplu.com

Plunger, Roller, One-way Tripper & Toggle Operated — 3-Way, 3-Port, 2-Position – 1/8" Ports

Plunger Operated

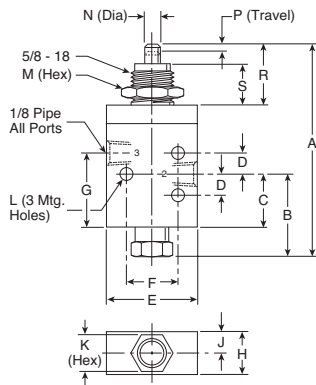

Roller Operated

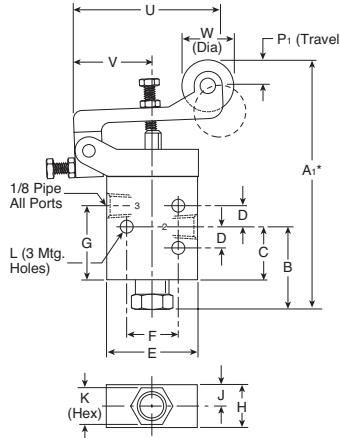

3-Way, 3-Port, 2-Position

A	A₁[*]	A₂[*]	A₃	B
3.37 (86)	4.21 (107)	4.46 (113)	3.99 (101)	1.03 (26)
C	D	E	F	G
.55 (14)	.31 (8)	1.31 (33)	.75 (19)	.90 (23)
H	J	K	L	M
.62 (16)	.31 (8)	.56 (14)	.19 (5)	.88 (22)
N	P	P₁	R	R₁
.25 (6)	.17 (4)	.38 (10)	.91 (23)	1.53 (39)
S	S₁	U	V	W
.62 (16)	.78 (20)	2.28 (58)	1.19 (30)	.75 (19)
X	Y			
.19 (5)	2.19 (56)			

One-Way Tripper Operated

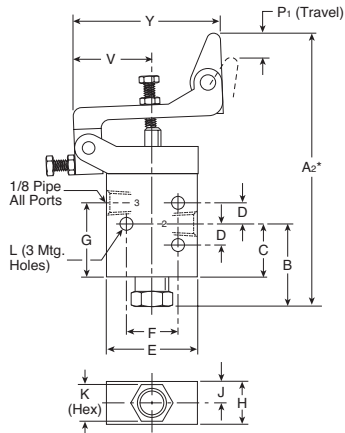

Toggle Operated

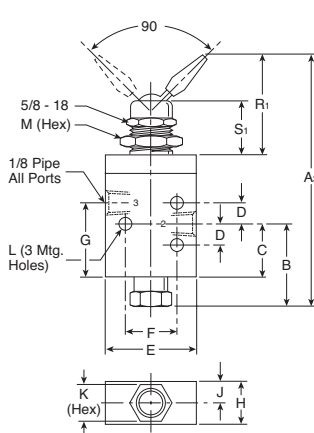

* Dimensions may be reduced .44" using adjusting screw.
 Inches (mm)

Button & Hand Lever Operated — 3-Way, 3-Port, 2-Position – 1/8" Ports

Button Operated

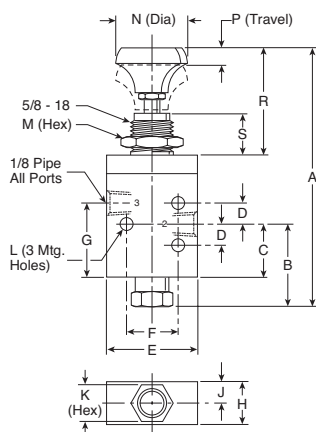

Hand Lever Operated

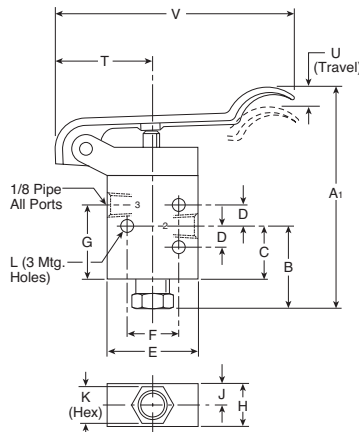

3-Way, 3-Port, 2-Position

A	A₁	B	C	D
4.13 (105)	3.34 (85)	1.03 (26)	.55 (14)	.31 (8)
E	F	G	H	J
1.31 (33)	.75 (19)	.90 (23)	.62 (16)	.31 (8)
K	L	M	N	P
.56 (14)	.19 (5)	.88 (22)	1.06 (27)	.17 (4)
R	S	T	U	V
1.67 (42)	.63 (16)	1.19 (30)	.53 (13)	3.38 (86)

Inches (mm)



For inventory, lead times, and kit lookup, visit www.pdnplu.com

Directair 2 & 4 Series
 Viking Xtreme Lever Series
 42 Lever / Pedal Series
 M0 Series
 Safety
 Manual / Mechanical Valves
 Brass Poppet / Sliding Seal
 Control Panel Products
 Sensing

Plunger, Roller, One-way Tripper & Toggle Operated — 3-Way, 3-Port, 2-Position – 1/8" Ports

Plunger Operated

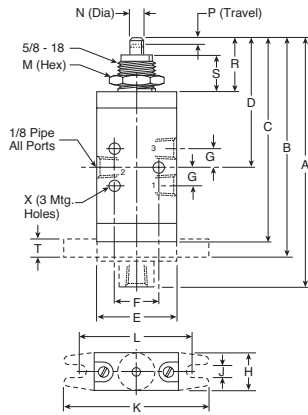

Roller Operated

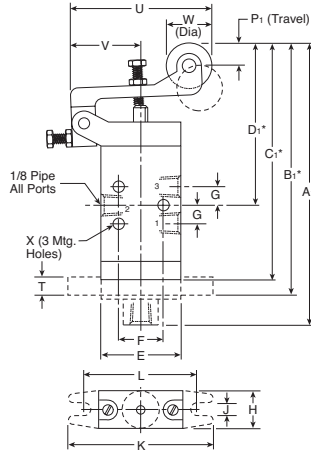

One-Way Tripper Operated

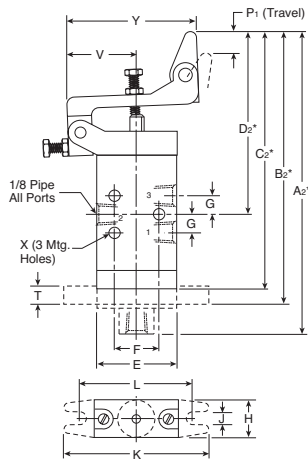

Toggle Operated

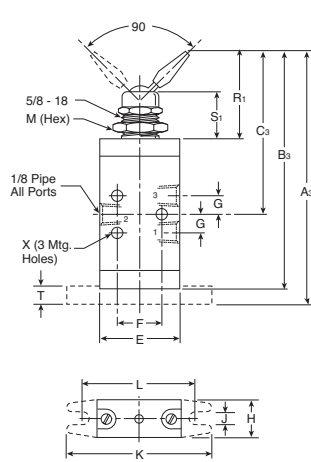

3-Way, 3-Port, 2-Position

A 4.14 (105)	A1* 4.98 (126)	A2* 5.23 (133)	A3 4.23 (107)	B 3.61 (92)
B1 4.45 (113)	B2 4.70 (119)	B3 4.00 (102)	C 3.38 (86)	C1 4.22 (107)
C2 4.47 (113)	C3 2.75 (70)	D 2.05 (52)	D1 2.98 (76)	D2 3.22 (82)
E 1.31 (33)	F .75 (19)	G .31 (8)	H .62 (16)	J .20 (5)
K 2.38 (60)	L 1.88 (48)	M .88 (22)	N .25 (6)	P .17 (4)
P1 .38 (10)	R .91 (23)	R1 1.53 (39)	S .62 (16)	S1 .78 (20)
T .25 (6)	U 2.28 (58)	V 1.19 (30)	W .75 (19)	X .19 (5)
Y 2.19 (56)				

* Dimensions may be reduced .44" using adjusting screw.
Inches (mm)

Button, Hand Lever Operated — 3-Way, 3-Port, 2-Position – 1/8" Ports

Button Operated

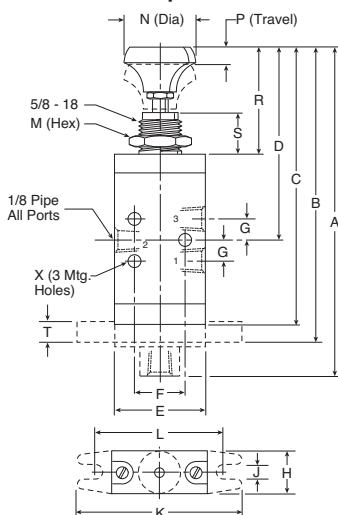

Hand Lever Operated

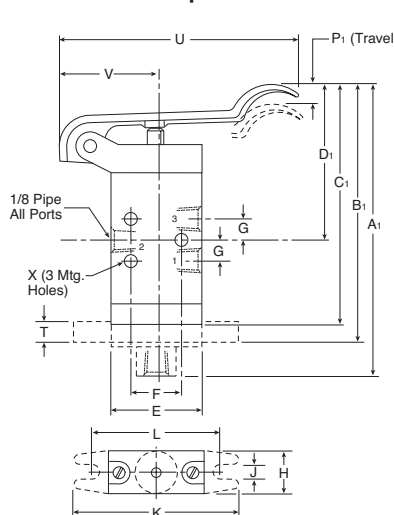

3-Way, 3-Port, 2-Position

A 5.08 (129)	A1 4.29 (109)	B 4.55 (115)	B1 3.77 (96)	C 4.31 (109)
C1 3.53 (90)	D 3.08 (78)	D1 2.29 (58)	E 1.31 (33)	F .75 (19)
G .31 (8)	H .62 (16)	J .20 (5)	K 2.38 (60)	L 1.88 (48)
M .88 (22)	N 1.06 (27)	P .17 (4)	P1 .53 (13)	R 1.67 (42)
S .63 (16)	T .25 (6)	U 3.38 (86)	V 1.19 (30)	X .19 (5)
Y .59 (15)				

Inches (mm)



For inventory, lead times, and kit lookup, visit www.pdnplu.com

Directair 2 & 4 Series

Viking Xtreme Lever Series

4:2 Lever / Pedal Series

M0 Series

Safety



Manual / Mechanical Valves

Brass Poppet / Sliding Seal

Control Panel Products

Sensing

Plunger, Roller, One-way Tripper & Toggle Operated — 4-Way, 5-Port, 2-Position – 1/8" Ports

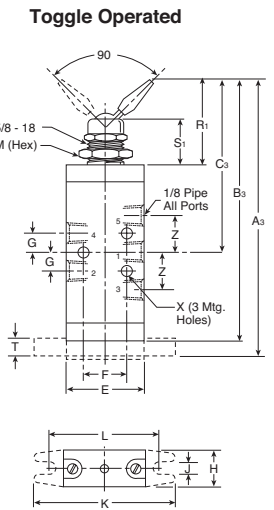
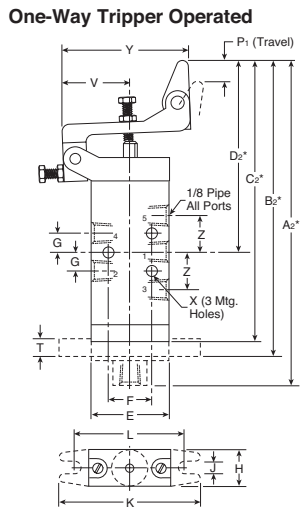
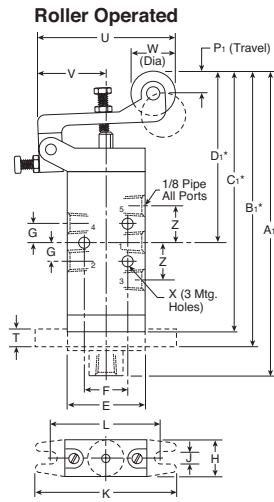
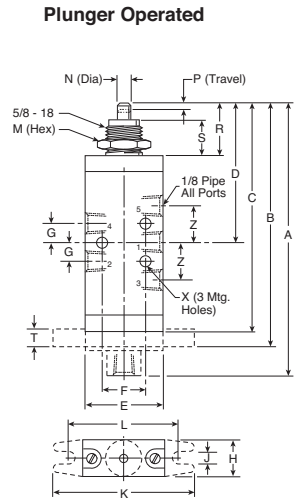

4-Way, 5-Port, 2-Position

A	A1*	A2*	A3	B
4.75 (121)	5.59 (142)	5.84 (148)	4.84 (123)	4.22 (107)
B1*	B2*	B3	C	C1*
5.06 (128)	5.31 (135)	4.61 (117)	3.99 (102)	4.83 (123)
C2*	C3	D	D1*	D2*
5.08 (129)	3.06 (78)	2.44 (62)	3.28 (83)	3.53 (90)
E	F	G	H	J
1.31 (33)	.75 (19)	.31 (8)	.62 (16)	.20 (5)
K	L	M	N	P
2.38 (60)	1.88 (48)	.88 (22)	.25 (6)	.17 (4)
P1	R	R1	S	S1
.38 (10)	.91 (23)	1.53 (39)	.62 (16)	.78 (20)
T	U	V	W	X
.25 (6)	2.28 (58)	1.19 (30)	.75 (19)	.19 (5)
Y	Z			
2.19 (56)	.62 (16)			

* Dimensions may be reduced .44" using adjusting screw.
 Inches (mm)

Button & Hand Lever Operated — 4-Way, 5-Port, 2-Position – 1/8" Ports

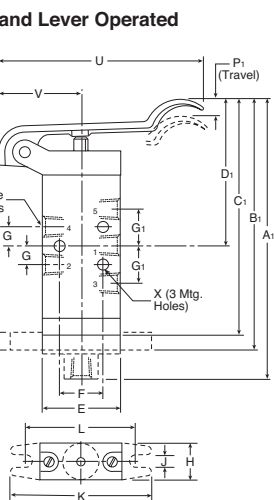
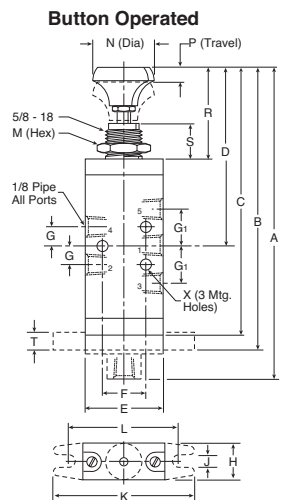

4-Way, 5-Port, 2-Position

A	A1	B	B1	C
5.69 (144)	4.90 (124)	5.16 (131)	4.38 (111)	4.92 (125)
C1	D	D1	E	F
4.14 (105)	3.67 (93)	2.90 (74)	1.31 (33)	.75 (19)
G	G1	H	J	K
.31 (8)	.63 (16)	.62 (16)	.20 (5)	2.38 (60)
L	M	N	P	P1
1.88 (48)	.88 (22)	1.06 (27)	.17 (4)	.53 (13)
R	S	T	U	V
1.67 (42)	.63 (16)	.25 (6)	3.38 (86)	1.19 (30)
X	Y			
.19 (5)	.59 (15)			

Inches (mm)



For inventory, lead times, and kit lookup, visit www.pdnplu.com

E11

Parker Hannifin Corporation
 Pneumatic Division
 Richland, Michigan
www.parker.com/pneumatics

Directair 2
& 4 Series

Viking Xtreme
Lever Series

42 Lever/
Pedal Series

M0 Series

Safety



Manual / Mechanical
Valves

Brass Poppet /
Sliding Seal

Control Panel
Products

Sensing

Dimensional Data

Button & Roller Operated — 3-Way, 3-Port, 2-Position

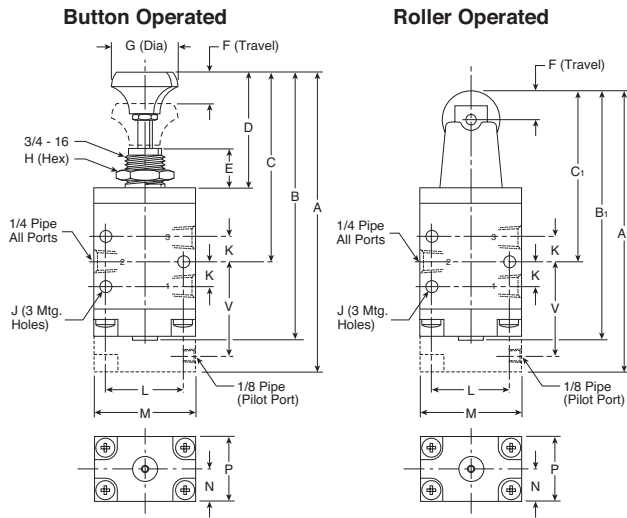

3-Way, 3-Port, 2-Position

A	A ₁	B	B ₁	C
4.91 (125)	4.25 (108)	4.44 (113)	3.78 (96)	3.10 (79)
C ₁	D	E	F	G
2.44 (62)	2.00 (51)	.63 (16)	.32 (8)	1.05 (27)
H	J	K	L	M
1.00 (25)	.19 (5)	.41 (10)	1.25 (32)	1.63 (42)
N	P	V		
.53 (14)	1.06 (27)	1.52 (39)		

Inches (mm)

Lever & Pedal Operated — 3-Way, 3-Port, 2 & 3-Position

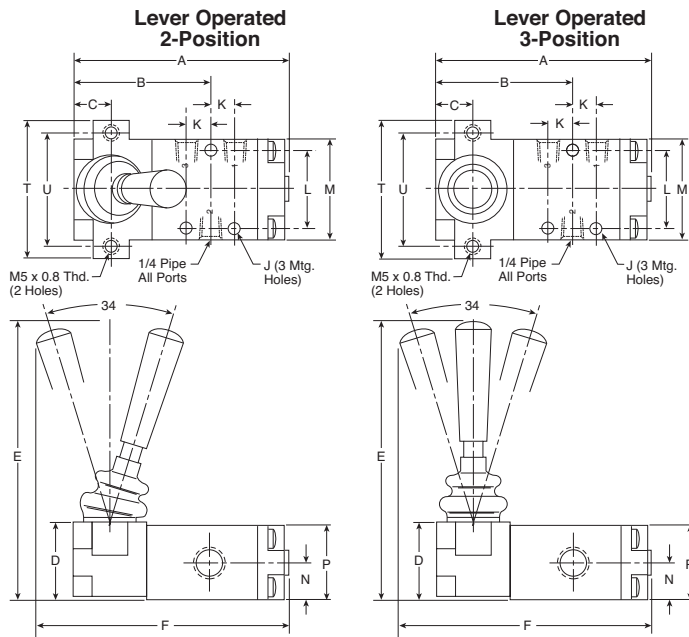

3-Way, 3-Port, 2 & 3-Position

A	A ₁	B	B ₁	C
3.31 (84)	6.55 (166)	1.97 (50)	5.20 (132)	.53 (14)
C ₁	D	E	F	J
2.19 (56)	1.12 (28)	4.06 (103)	3.90 (99)	.19 (5)
K	L	M	N	P
.41 (10)	1.25 (32)	1.63 (42)	.53 (14)	1.06 (27)
Q	R	S	T	T ₁
.37 (10)	2.40 (61)	.34 (9)	2.13 (54)	3.50 (89)
U	U ₁			
1.75 (44)	3.00 (76)			

Inches (mm)

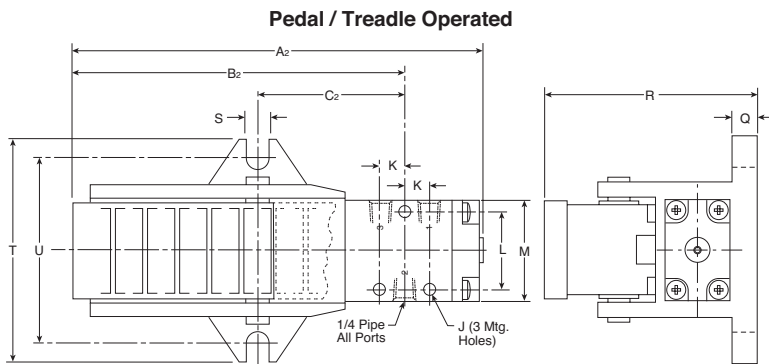

CAUTION:

This valve shall not be used to actuate a punch press. Do not use this valve on punch presses or press brakes. See OSHA 1910.217.



For inventory, lead times, and kit lookup, visit www.pdnplu.com

Directair 2 & 4 Series
 Viking Xtreme Lever Series
 42 Lever / Pedal Series
 M0 Series
 Safety
 Manual / Mechanical Valves
 Brass Poppet / Sliding Seal
 Control Panel Products
 Sensing

Button, Roller, Pedal & Treadle, Lever Operated — 4-Way, 5-Port, 2-Position

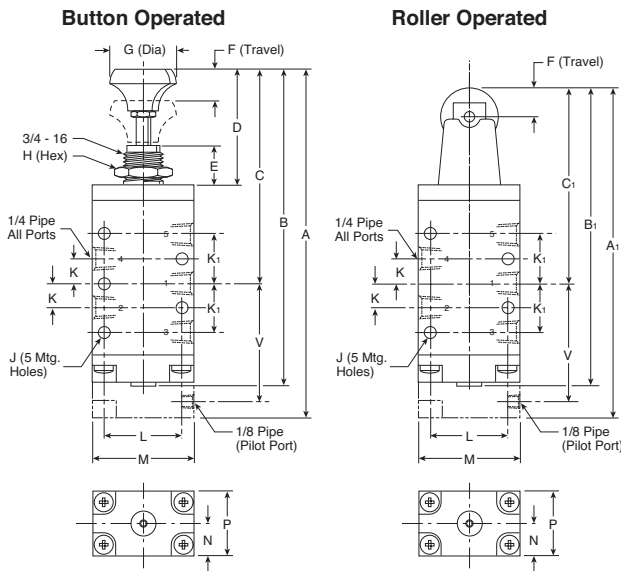

4-Way, 5-Port, 2-Position

A	A₁	A₂	B	B₁
5.75 (146)	5.13 (130)	7.41 (189)	5.28 (134)	4.66 (118)
B₂	C	C₁	C₂	D
5.63 (143)	3.50 (89)	2.88 (73)	2.64 (67)	2.00 (51)
E	F	G	H	J
.63 (16)	.32 (8)	1.05 (27)	1.00 (25)	.19 (5)
K	K₁	L	M	N
.44 (11)	.84 (21)	1.25 (32)	1.63 (41)	.53 (14)
P	Q	R	S	T
1.06 (27)	.37 (10)	2.40 (61)	.34 (9)	3.50 (89)
U	V			
3.00 (76)	1.96 (50)			

Inches (mm)

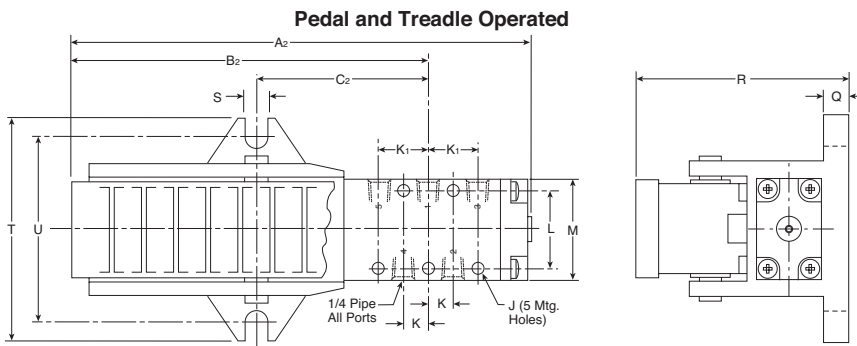

CAUTION:
 This valve shall not be used to actuate a punch press.
 Do not use this valve on punch presses or press brakes.
 See OSHA 1910.217.

Lever Operated — 4-Way, 5-Port, 2 & 3-Position

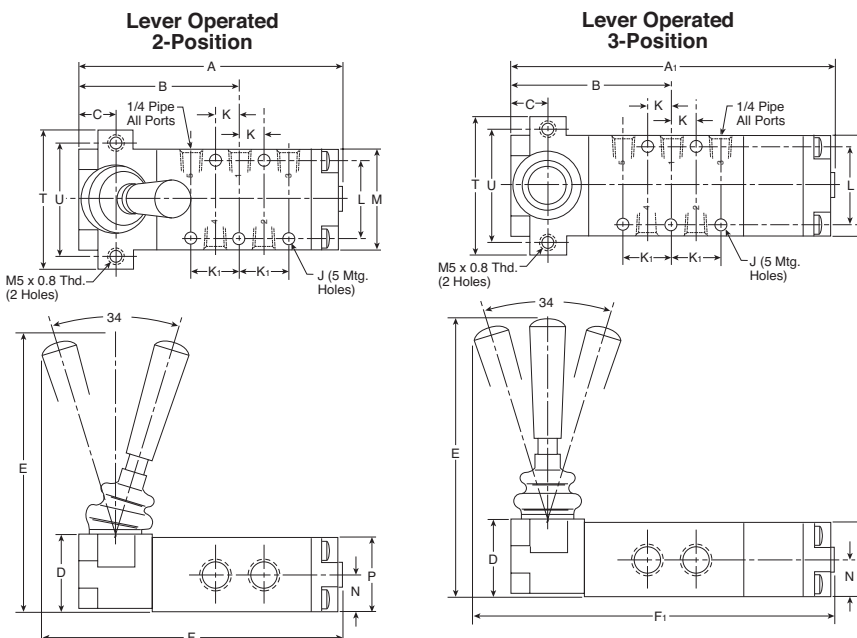

4-Way, 5-Port, 2 & 3-Position

A	A₁	B	C	D
4.19 (106)	5.09 (129)	2.41 (61)	.53 (14)	1.12 (28)
E	F	F₁	J	K
4.06 (103)	4.78 (121)	5.78 (147)	.19 (5)	.44 (11)
K₁	L	M	N	P
.84 (21)	1.25 (32)	1.63 (42)	.53 (14)	1.06 (27)
T	U			
2.13 (54)	1.75 (44)			

Inches (mm)



For inventory, lead times, and kit lookup, visit www.pdnplu.com

Directair 2
& 4 Series

Viking Xtreme
Lever Series

42 Lever/
Pedal Series

M0 Series

Safety



Manual / Mechanical
Valves

Brass Poppet /
Sliding Seal

Control Panel
Products

Sensing

Features

Viking Xtreme Manual Series

The Viking Xtreme Manual valve range is robust, versatile and combines high performance with compact installation dimensions. The valves rugged lever actuator has been specifically designed for gloved hands to suit mobile applications in the most arduous of environments. Available in 3/2, 5/2 and 5/3 functions with either spring return or detented lever. The lever actuated versions are available across the entire range from 1/8 to 1/2 port sizes.

- **Heavy duty lever**
- **Inline valve**
 - 1/8", 1/4", 3/8", 1/2" NPT & BSPP
- **2-position models**
 - 4-way & 3-way
- **3-position models**
 - all ports blocked
 - pressure center
 - center exhaust
- **Approval**
 - Canada Registration Number available (CRN)
- **Over-moulded single piece aluminium spool**
 - Reduced product complexity
 - Increased flow
 - Wide operating temperature range
 - Stable seal performance even with high flow / pressure drop across spool.



Operating information

Operating pressure: Type A & B: Vacuum to 232 PSIG (Vacuum to 16 bar Max.)
 Type C & D: Vacuum to 174 PSIG (Vacuum to 12 bar Max.)
 Temperature range: Xtreme: -40°F to 140°F (-40°C to 60°C)

Material specifications

End covers	Anodized aluminum
Lever	Reinforced polyamide plastic
Lever housing	Acetal plastic
Piston	Acetal plastic / anodized aluminum
Seals	Nitrile rubber
Screws	Stainless steel
Spool	Aluminum & nitrile rubber
Springs	Stainless steel
Valve body	Anodized aluminum

Lever Handle – 1/8" valve size, 5/2 & 5/3 only	Twist Handle – 1/4" valve sizes	Lever Handle – All other valve sizes

Features

- Variety of manual actuators
- Robust Knobs
- Stainless steel shafts
- Handle boots for ingress protection
- **Over Molded Spool**
 - Aluminum spool with nitrile rubber coating ground to exact size for optimum performance
 - Precision ground for maximum performance
 - Wide operating temperature range
 - Low temperature to -40°
- Robust anodized aluminum valve body
- Diecast end covers with stainless steel screws to resist aggressive environments.
- Sintered bronze pilot chamber breathers provide increased protection against ingress of dust and dirt.
- The bore is polished to a very high surface finish for maximum flow capacity and long life.
- Stainless steel return spring



For inventory, lead times, and kit lookup, visit www.pdnplu.com

Directair 2 & 4 Series

Viking Xtreme Lever Series

4/2 Lever / Pedal Series

MO Series

Safety





Manual / Mechanical Valves



Brass Poppet / Sliding Seal

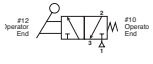

Control Panel Products

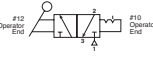

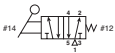
Sensing

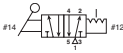
Common Part Numbers

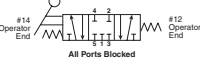
3/2 - 2-Position *	Symbol	Valve Type	Port Size	Cv	Weight lb (kg)	Part Number NPT	Part Number BSPP
 Size P2LXB Shown		Lever Spring Return	1/8	0.6	0.73 (0.33)	P2LAX391VS	P2LAX311VS
			1/4	1.5	0.73 (0.33)	P2LXB392VS	P2LXB312VS
			3/8	2.5	0.88 (0.40)	P2LCX393VS	P2LCX313VS
			1/2	2.7	1.32 (0.60)	P2LDX394VS	P2LDX314VS
 Size P2LAX Shown		Lever Detent	1/8	0.7	0.73 (0.33)	P2LAX391VV	P2LAX311VV
			1/4	1.3	0.73 (0.33)	P2LXB392VV	P2LXB312VV
			3/8	2.5	0.88 (0.40)	P2LCX393VV	P2LCX313VV
			1/2	2.7	1.32 (0.60)	P2LDX394VV	P2LDX314VV

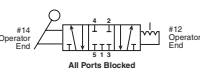
5/2 - 2-Position *	Symbol	Valve Type	Port Size	Cv	Weight lb (kg)	Part Number NPT	Part Number BSPP
 Size P2LXB Shown		Lever Spring Return	1/8	0.6	0.40 (0.18)	P2LAX591VS	P2LAX511VS
			1/4	1.5	0.73 (0.33)	P2LXB592VS	P2LXB512VS
			3/8	2.5	0.88 (0.40)	P2LCX593VS	P2LCX513VS
			1/2	2.7	1.32 (0.60)	P2LDX594VS	P2LDX514VS
 Size P2LAX Shown		Lever Detent	1/8	0.7	0.40 (0.18)	P2LAX591VV	P2LAX511VV
			1/4	1.3	0.73 (0.33)	P2LXB592VV	P2LXB512VV
			3/8	2.5	0.88 (0.40)	P2LCX593VV	P2LCX513VV
			1/2	2.7	1.32 (0.60)	P2LDX594VV	P2LDX514VV

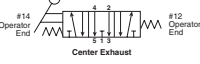
5/3 - 3-Position,* All Ports Blocked	Symbol	Valve Type	Port Size	Cv	Weight lb (kg)	Part Number NPT	Part Number BSPP
 Size P2LAX Shown		Lever Spring Center	1/8	0.6	0.40 (0.18)	P2LAX69111	P2LAX61111
			1/4	1.5	0.73 (0.33)	P2LXB69211	P2LXB61211
			3/8	2.5	1.56 (0.71)	P2LCX69311	P2LCX61311
			1/2	2.7	1.61 (0.73)	P2LDX69411	P2LDX61411
 Size P2LXB Shown		Lever Detent	1/8	0.7	0.40 (0.18)	P2LAX69122	P2LAX61122
			1/4	1.3	0.73 (0.33)	P2LXB69222	P2LXB61222
			3/8	2.5	1.56 (0.71)	P2LCX69322	P2LCX61322
			1/2	2.7	1.61 (0.73)	P2LDX69422	P2LDX61422

5/3 - 3-Position,* Center Exhaust	Symbol	Valve Type	Port Size	Cv	Weight lb (kg)	Part Number NPT	Part Number BSPP
 Size P2LDX Shown		Lever Spring Center	1/8	0.6	0.40 (0.18)	P2LAX89111	P2LAX81111
			1/4	1.5	0.73 (0.33)	P2LXB89211	P2LXB81211
			3/8	2.5	1.56 (0.71)	P2LCX89311	P2LCX81311
			1/2	2.7	1.61 (0.73)	P2LDX89411	P2LDX81411
 Size P2LXB Shown		Lever Detent	1/8	0.7	0.40 (0.18)	P2LAX89122	P2LAX81122
			1/4	1.3	0.73 (0.33)	P2LXB89222	P2LXB81222
			3/8	2.5	1.56 (0.71)	P2LCX89322	P2LCX81322
			1/2	2.7	1.61 (0.73)	P2LDX89422	P2LDX81422

* Valve lever movement 90° to ports.

 Most popular.



For inventory, lead times, and kit lookup, visit www.pdnplu.com

Directair 2
& 4 Series

Viking Xtreme
Lever Series

42 Lever/
Pedal Series

M0 Series

Safety









Manual / Mechanical
Valves

Brass Poppet /
Sliding Seal

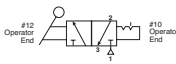
Control Panel
Products

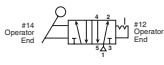
Sensing

Common Part Numbers

3/2 - 2-Position	Symbol	Valve Type	Port Size	Cv	Part Number NPT	Part Number BSPP
		Twist Handle Detent	1/4	1.3 0.73 (0.33)	P2LBX392JJ	P2LBX312JJ
5/2 - 2-Position	Symbol	Valve Type	Port Size	Cv	Part Number NPT	Part Number BSPP
		Twist Handle Detent	1/4	1.3 0.73 (0.33)	P2LBX592JJ	P2LBX512JJ
5/2 - 2-Position *	Symbol	Valve Type	Port size	Cv	Part Number NPT	Part Number BSPP
		Lever Spring Return	1/4	1.3 0.73 (0.33)	P2LBX592ZS	P2LBX512ZS
		Lever Detent	1/4	1.3 0.73 (0.33)	P2LBX592ZZ	P2LBX512ZZ

* Valve lever movement inline to ports.

Viking Xtreme Manual Operated Valves

Vacuum to 232 PSIG (Vacuum to 16 bar) -40°F to 140°F (-40°C to 60°C)

P2L A X 5 91 VS

Valve Size	
1/8"	A
1/4"	B
3/8"	C
1/2"	D

Valve Type / Function	
3/2 NC - 2-Position	3
5/2 2-Position	5
5/3 3-Position, APB	6
5/3 3-Position, PC	7
5/3 3-Position, CE	8

Actuator / Position / Lever	
JJ*	Twist Handle Detent, 2-Position
VS	Spring Return Lever, 2-Position, 90° to Ports
VV	Lever, Detent, 2-Position, 90° to Ports
ZS**	Spring Return Lever, 2-Position, Inline to Ports
ZZ**	Lever Detent, 2-Position, Inline to Ports
11	Spring Centered Lever, 3-Position, 90° to Ports
22	Lever, Detent, 3-Position, 90° to Ports
55**	Spring Return Lever, 3-Position, Inline to Ports
66**	Lever Detent, 3-Position, Inline to Ports

* Not available with 3-position valves or main port thread 1N or 9N, valve size B only.
 ** Size B valve only.

Main Port Thread	
11	G1/8 (P2LA)
12	G1/4 (P2LB)
1N*	G1/4 (P2LB) NAMUR Mount
13	G3/8 (P2LC)
14	G1/2 (P2LD)
91	1/8" NPT (P2LA)
92	1/4" NPT (P2LB)
9N*	1/4 NPT (P2LB) NAMUR Mount
93	3/8" NPT (P2LC)
94	1/2" NPT (P2LD)

* 5/2, 2-position valve only.

 Most popular.



For inventory, lead times, and kit lookup, visit www.pdnplu.com

Directair 2 & 4 Series
 Viking Xtreme Lever Series
 4/2 Lever / Pedal Series
 M0 Series
 Safety
 Manual / Mechanical Valves
 Brass Poppet / Sliding Seal
 Control Panel Products
 Sensing

Exhaust Mufflers

Pipe Thread	Part Number
M5	P6M-PAC5
1/8" NPT	EM12
1/4" NPT	EM25
3/8" NPT	EM37
1/2" NPT	EM50

P6M - Plastic; EM - Sintered bronze



Plastic Silencers

Thread Size	Part Number			A (mm)	B (mm)
	NPT	BSPT	Metric		
M5			AS-5	.43 (11)	.32 (8)
1/8"	ASN-6	AS-6		1.57 (40)	.63 (16)
1/4"	ASN-8	AS-8		2.56 (65)	.83 (21)
3/8"	ASN-10	AS-10		3.35 (85)	.98 (25)
1/2"	ASN-15	AS-15		3.74 (95)	1.18 (30)



Exhaust Protector

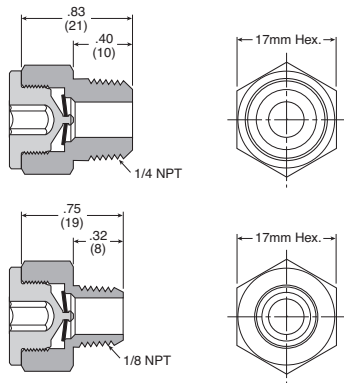

Specifications

Operating pressure 0 – 150 PSIG
 (0 to 10 bar, 0 to 1034 kPa)

Operating temperature -40°F to 158°F (-40°C to 70°C)

Material:

Body and pipe adapter Brass
 Membrane Fluorocarbon

Flow Data (SCFM)

Part Number	Size	60 PSIG Inlet	90 PSIG Inlet	125 PSIG Inlet
E90016	1/8"	40.1	56.5	75.5
E90017	1/4"	44.6	62.7	83.5

Features

- 1/8 and 1/4 NPT male sizes
- Fitted with a brass pipe adapter and a fluorocarbon membrane
- Resistant to rust, clog, wash down and contamination

Applications

These protectors are intended for mobile applications, quick venting applications and alternative exhaust port breathers that require protection against clogging.

Ideal for valves exposed to harsh environmental conditions (which can cause a “caking up” in the exhaust pipe ports where the bronze mufflers or breather vents are installed).

Particularly suitable for time-sensitive applications such as axle-lift suspensions or pushers or tag axles.

Directair 2 & 4 Series

Viking Xtreme Lever Series

42 Lever / Pedal Series

M0 Series

Safety



Manual / Mechanical Valves

Brass Poppet / Sliding Seal

Control Panel Products

Sensing



For inventory, lead times, and kit lookup, visit www.pdnplu.com

Dimensional Data

P2LAX 3/2 Hand Lever Operated
 Lever operation 90° to ports movement

P2LAX 3/2

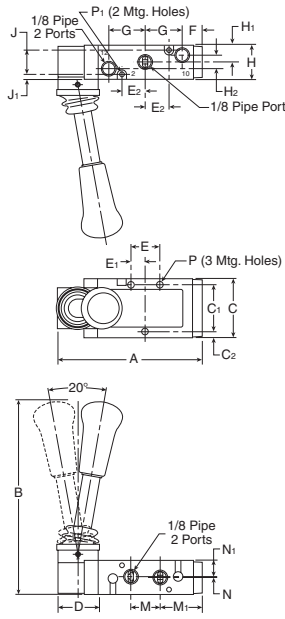

A	B	C
3.88 (99)	5.23 (133)	1.57 (40)
C ₁	C ₂	D
1.26 (32)	.16 (4)	1.06 (27)
E	E ₁	E ₂
.79 (20)	.39 (10)	.63 (16)
F	G	H
.55 (14)	.98 (25)	.87 (22)
H ₁	H ₂	J
.42 (10.6)	.02 (0.5)	.65 (16.5)
J ₁	M	M ₁
.11 (2.9)	.79 (20)	1.14 (29)
N	N ₁	P
.18 (4.5)	.26 (6.6)	Ø .17 (Ø 4.3)
P ₁	Ø .12 (Ø 3.1)	

Inches (mm)

P2LAX 5/2 & 5/3 Hand Lever Operated
 Lever operation 90° to ports movement

P2LAX 5/2 & 5/3

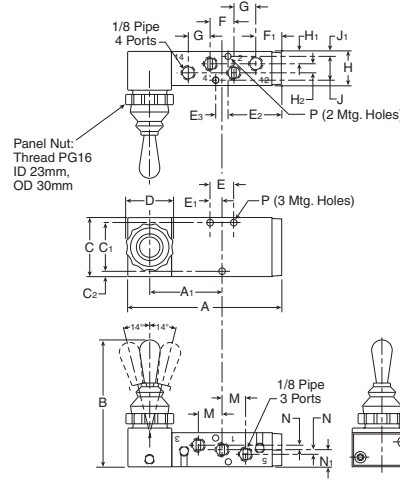

A	A ₁	B
4.02 (102)	1.89 (48)	3.23 (82)
C	C ₁	C ₂
1.57 (40)	1.30 (33)	.14 (3.5)
D	E ₂	E ₃
1.18 (30)	1.42 (36)	.33 (8.5)
F	F ₁	G
.63 (16)	.67 (17)	.59 (15)
H	H ₁	H ₂
.87 (22)	.31 (8)	.24 (6)
J	J ₁	M
.63 (16)	.12 (3)	.63 (16)
N	N ₁	P
.12 (3)	.43 (11)	Ø .16 (Ø 4.1)

Inches (mm)

P2LBX 3/2 Hand Lever Operated
 Lever operation 90° to ports movement

P2LBX 3/2

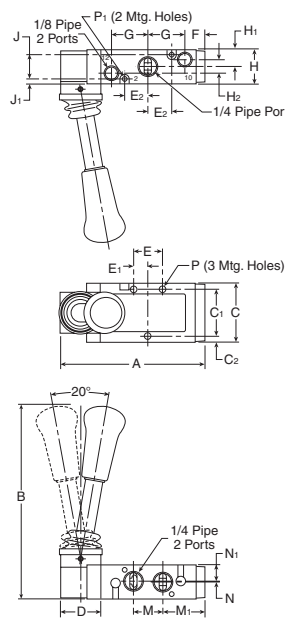

A	B	C
3.88 (99)	5.23 (133)	1.57 (40)
C ₁	C ₂	D
1.26 (32)	.16 (4)	1.06 (27)
E	E ₁	E ₂
.79 (20)	.39 (10)	.63 (16)
F	G	H
.55 (14)	.98 (25)	.87 (22)
H ₁	H ₂	J
.42 (10.6)	.02 (0.5)	.65 (16.5)
J ₁	M	M ₁
.11 (2.9)	.79 (20)	1.14 (29)
N	N ₁	P
.18 (4.5)	.26 (6.6)	Ø .17 (Ø 4.3)
P ₁	Ø .12 (Ø 3.1)	

Inches (mm)

P2LBX 5/2 & 5/3 Hand Lever Operated
 Lever operation 90° to ports movement

P2LBX 5/2 & 5/3

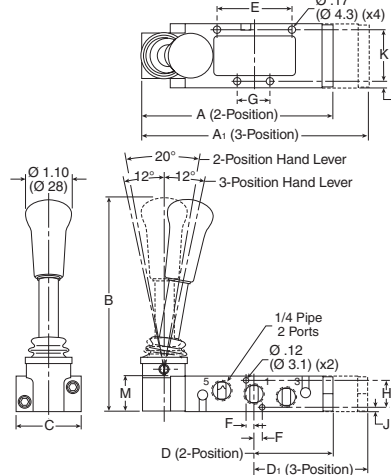

A	A ₁	B	
4.67 (118.5)	5.51 (140)	5.19 (131.8)	
C	D	D ₁	
1.57 (40)	1.93 (49)	2.35 (59.8)	
E	F	G	
1.81 (46)	.20 (5)	.79 (20)	
H	J	K	
.65 (16.5)	.11 (2.85)	1.26 (32)	
L	M		
.16 (4)	.87 (22.2)		

Inches (mm)

Directair 2
& 4 Series

Viking Xtreme
Lever Series

4/2 Lever /
Pedal Series

M0 Series

Safety



Manual / Mechanical
Valves

Brass Poppet /
Sliding Seal

Control Panel
Products

Sensing



For inventory, lead times, and kit lookup, visit www.pdnplu.com

E17-a

Parker Hannifin Corporation
 Pneumatic Division
 Richland, Michigan
www.parker.com/pneumatics

P2LCX 3/2 Hand Lever Operated
 Lever operation 90° to ports movement

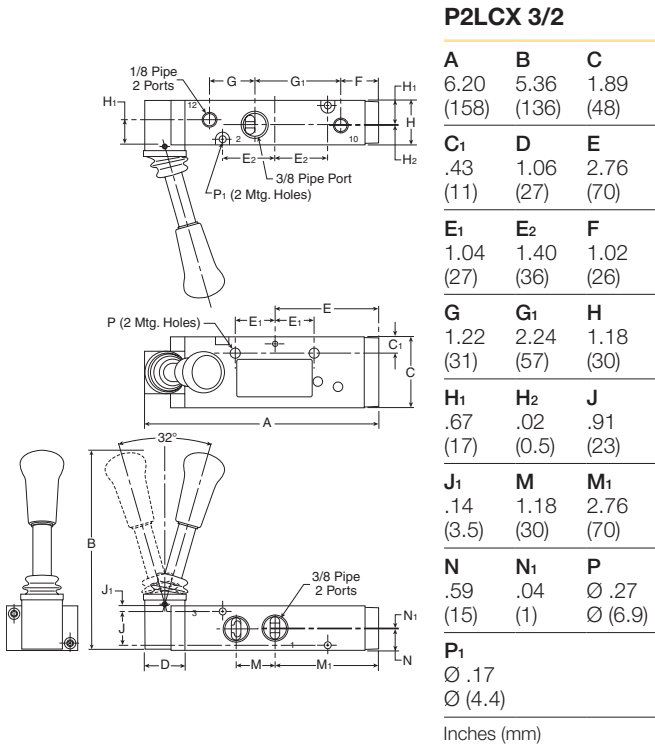

P2LCX 5/2 & 5/3 Hand Lever Operated
 Lever operation 90° to ports movement

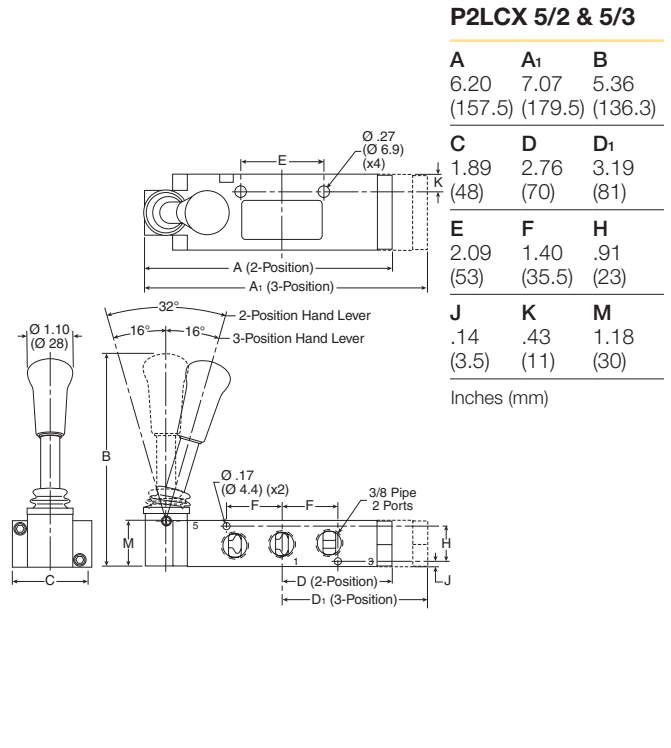

P2LDX 3/2 Hand Lever Operated
 Lever operation 90° to ports movement

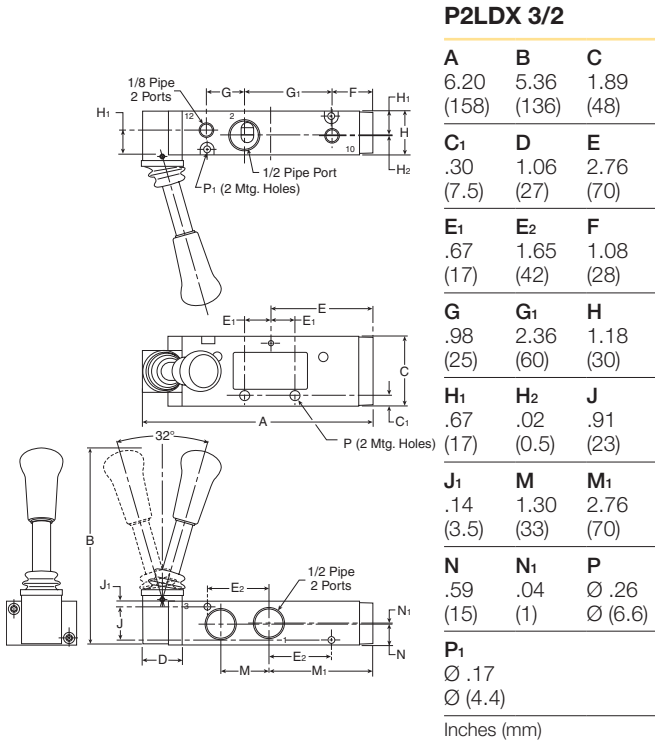

P2LDX 5/2 & 5/3 Hand Lever Operated
 Lever operation 90° to ports movement

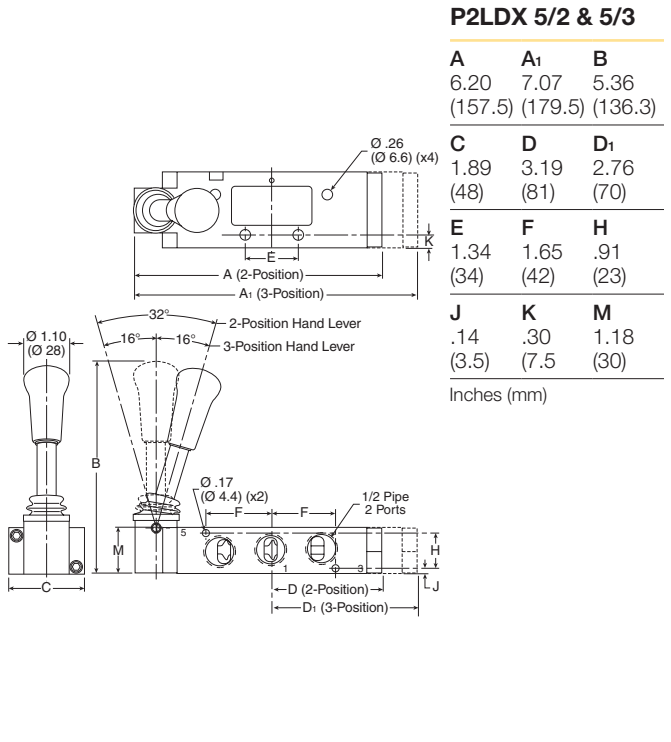

P2LBX 3/2 Twist Lever Operated

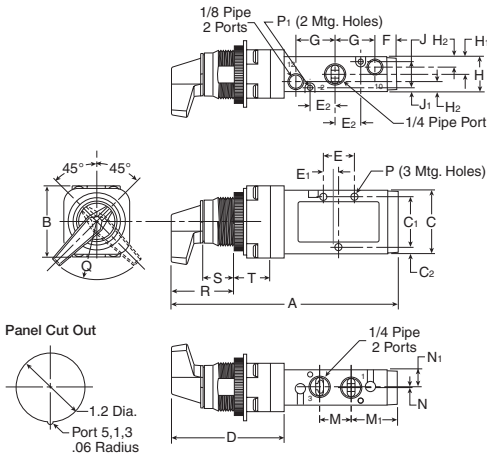

P2LBX 3/2

A	B	C	C ₁	C ₂	D	E	E ₁	E ₂
5.67 (144)	1.79 (45.5)	1.57 (40)	1.26 (32)	.16 (4)	2.87 (73)	.79 (20)	.39 (10)	.63 (16)
F	G	H	H ₁	H ₂	J	J ₁	M	M ₁
.55 (14)	.98 (25)	.87 (22.2)	.44 (11.1)	.26 (6.6)	.65 (16.5)	.11 (2.9)	.79 (20)	1.14 (29)
N	N ₁	P	P ₁	Q	R	S	T	
.02 (0.5)	.42 (10.6)	∅ .17 (4.3)	∅ .12 (3.1)	1.5R (38.1)R	1.85 (47)	1.10 (28)	.67 (17)	

Inches (mm)

P2LBX 5/2 Twist Lever Operated

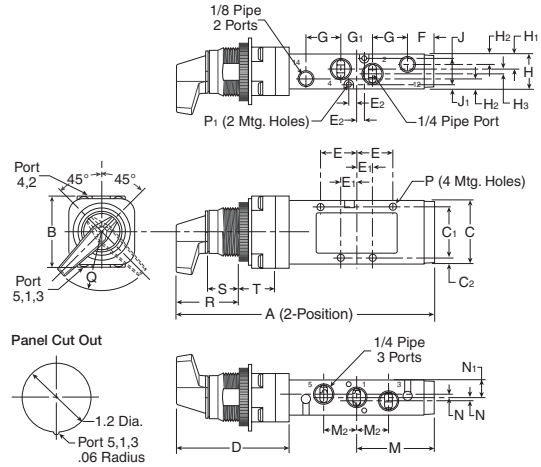

P2LBX 5/2

A	B	C	C ₁	C ₂	D	E	E ₁	E ₂	F
6.46 (164)	1.79 (45.5)	1.57 (40)	1.26 (32)	.15 (4)	2.87 (73)	.91 (23)	.39 (10)	.20 (5)	.67 (17)
G	G ₁	H	H ₁	H ₂	H ₃	J	J ₁	M	M ₂
.87 (22)	.79 (20)	.87 (22.2)	.44 (11.1)	.26 (6.6)	.12 (3)	.65 (16.5)	.11 (2.9)	1.93 (49)	.79 (20)
N	N ₁	P	P ₁	Q	R	S	T		
.08 (0.2)	.44 (11.1)	∅ .17 (4.3)	∅ .12 (3.1)	1.5R (38.1)R	1.85 (47)	1.10 (28)	.67 (17)		

Inches (mm)

P2LBX 3/2 Knob Lever Operated
 Lever operation inline with ports

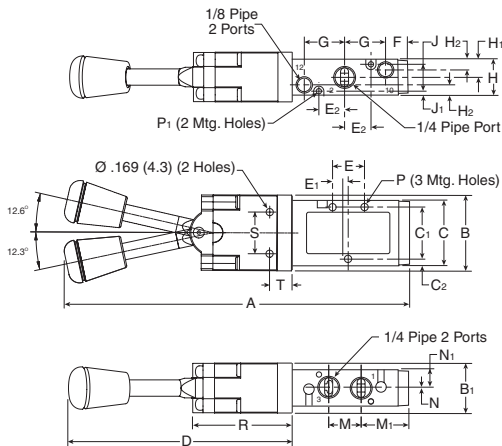

P2LBX 3/2

A	B	B ₁	C	C ₁	C ₂	D	E	E ₁
8.19 (208)	1.79 (45.5)	1.2 (30.5)	1.57 (40)	1.26 (32)	.16 (4)	5.39 (137)	.79 (20)	.39 (10)
E ₂	F	G	H	H ₁	H ₂	J	J ₁	M
.63 (16)	.55 (14)	.98 (25)	.87 (22.2)	.44 (11.1)	.26 (6.6)	.65 (16.5)	.11 (2.9)	.79 (20)
M ₁	N	N ₁	P	P ₁	R	S	T	
1.14 (29)	.02 (0.5)	.42 (10.6)	∅ .17 (4.3)	∅ .12 (3.1)	2.38 (60.5)	.98 (25.0)	.52 (13.2)	

Inches (mm)

P2LBX 5/2 & 5/3 Knob Lever Operated
 Lever operation inline with ports

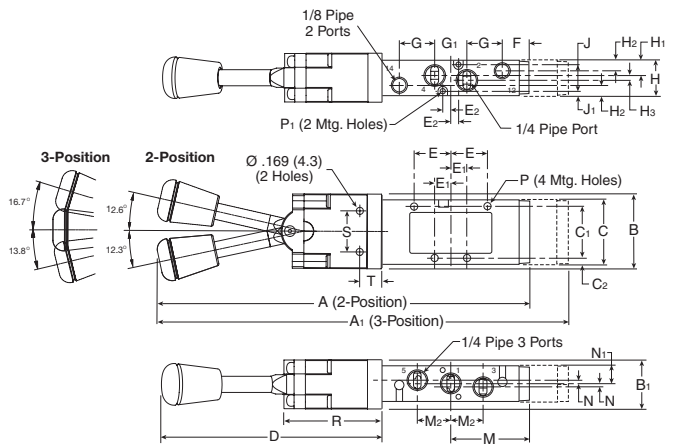

P2LBX 5/2 & 5/3

A	A ₁	B	B ₁	C	C ₁	C ₂	D	E	E ₁
8.97 (228)	9.84 (250)	1.79 (45.5)	1.2 (30.5)	1.57 (40)	1.26 (32)	.15 (4)	5.39 (137)	.91 (23)	.39 (10)
E ₂	F	G	G ₁	H	H ₁	H ₂	H ₃	J	J ₁
.20 (5)	.67 (17)	.87 (22)	.79 (20)	.87 (22.2)	.44 (11.1)	.26 (6.6)	.12 (3)	.65 (16.5)	.11 (2.9)
M	M ₂	N	N ₁	P	P ₁	R	S	T	
1.93 (49)	.79 (20)	.08 (0.2)	.44 (11.1)	∅ .17 (4.3)	∅ .12 (3.1)	2.38 (60.5)	.98 (25.0)	.52 (13.2)	

Inches (mm)

Directair 2
& 4 Series

Viking Xtreme
Lever Series

4:2 Lever /
Pedal Series

M0 Series

Safety



Manual / Mechanical
Valves

Brass Poppet /
Sliding Seal

Control Panel
Products

Sensing



For inventory, lead times, and kit lookup, visit www.pdnplu.com

Features

42 Lever / Pedal Series

Heavy duty lever

- Parallel mount handle
- Perpendicular mount handle

Heavy duty foot pedal

1 port size

- 3/8" port – 1.3 to 2.9 Cv

2-position

- 4-way

3-position valves

- All ports blocked
- Center exhaust



Operating information

Operating pressure: Vacuum to 150 PSI (710 mmHg to 1035 kPa)
Temperature range: 0°F to 140°F (-18°C to 60°C)

Lever Valve - 2-Position

	Symbol	Port Size	Cv	Description	Valve Type	Part Number
		3/8"	2.9	Inline, parallel	2-position, spring return	422CS021K
		3/8"	2.9	Inline, parallel	2-position, detent	422CS021W
		3/8"	2.9	Inline, perpendicular	2-position, spring return	422CR021K
		3/8"	2.9	Inline, perpendicular	2-position, detent	422CR021W

Lever Valve - 3-Position

	Symbol	Port Size	Cv	Description	Valve Type	Part Number
		3/8"	1.3	Inline, parallel	3-position, APB	422CS023W
		3/8"	1.3	Inline, parallel	3-position, CE	422CS024W
		3/8"	1.3	Inline, perpendicular	3-position, APB	422CR023W
		3/8"	1.3	Inline, perpendicular	3-position, CE	422CR024W

Foot Pedal Valve - 2-Position

	Symbol	Port Size	Cv	Description	Valve Type	Part Number
		3/8"	2.9	Foot pedal	2-position, spring return	422CT021K
				Foot pedal guard*		PS2043P

* This kit contains the valve mounting hardware.

CAUTION:

This valve shall not be used to actuate a punch press. Do not use this valve on punch presses or press brakes. See OSHA 1910.217.

Most popular.



For inventory, lead times, and kit lookup, visit www.pdnplu.com

Directair 2
& 4 Series

Viking Xtreme
Lever Series

42 Lever /
Pedal Series

M0 Series

Safety



Manual / Mechanical
Valves

Brass Poppet /
Sliding Seal

Control Panel
Products

Sensing

42 Lever / Pedal Series

422 C R 0 1 1 K

Operator #14 End	
Lever Perpendicular (Inline Only)	R
Lever Parallel	S
Foot Pedal (2-Position, Spring Return, Inline Only)	T

Operator #12 End	
K	Spring Return (2-Position Only)
W	Detented

Style	
NPT	0

Function (4-Way)	
2-Position	
1	Single Pressure
3-Position*	
3	Single Pressure - All Ports Blocked
4	Single Pressure - Cyl. Ports to Exhaust

* Available Detented Only.

Port Size	
2	3/8"

Valve body service kits

2-position valve	Single pressure	PS2038P
	Dual pressure	PS2039P
3-position valve	Single pressure	PS2041P

Kit includes: all soft seals and spool.

Most popular.



For inventory, lead times, and kit lookup, visit www.pdnplu.com

Directair 2 & 4 Series

Viking Xtreme Lever Series

42 Lever / Pedal Series

MO Series

Safety



Manual / Mechanical Valves

Brass Poppet / Sliding Seal

Control Panel Products

Sensing

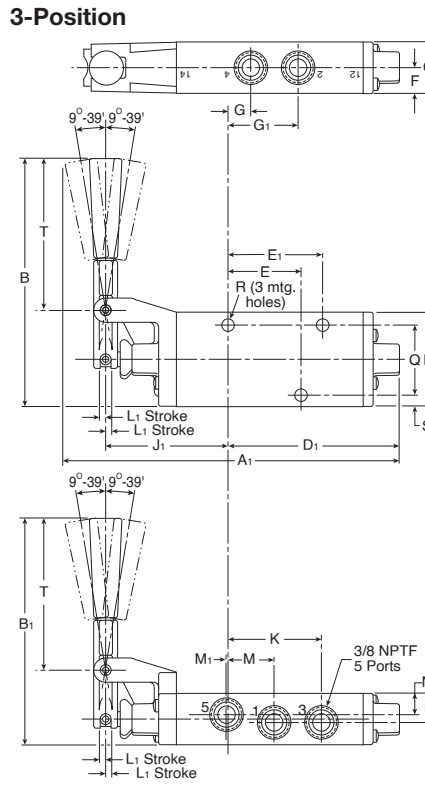
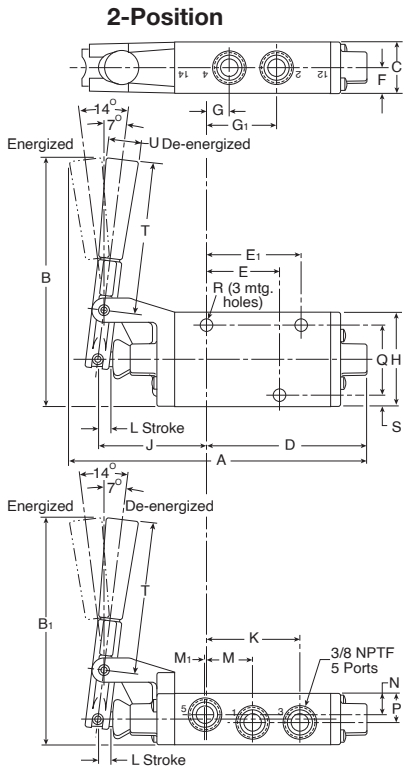

Lever Valve

A	A ₁	B	B ₁	C
6.70 (170)	7.58 (193)	5.55 (141)	5.05 (128)	1.15 (29)
D	D ₁	E	E ₁	F
3.59 (91)	3.83 (97)	1.58 (40)	2.06 (52)	.57 (14)
G	G ₁	H	J	J ₁
.55 (14)	1.51 (38)	2.13 (54)	2.44 (62)	2.80 (71)
K NPT	L	L ₁	M	L
2.13 (54)	.25 (6)	.18 (5)	1.03 (36)	.25 (6)
L ₁	M	M ₁ NPT	N	P
.18 (5)	1.03 (36)	.06 (2)	.50 (13)	.65 (17)
Q	R	S	T	U Dia
1.58 (40)	.33 (8)	.27 (7)	3.42 (87)	.75 (19)

Inches (mm)

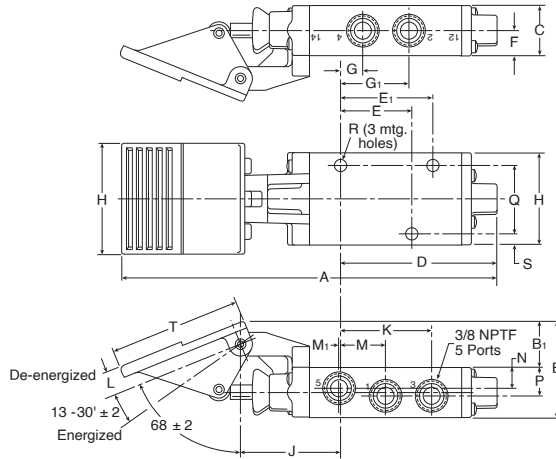

Foot Pedal Valve

A	B	B ₁	C	D
8.64 (220)	2.18 (55)	1.03 (26)	1.15 (29)	3.59 (91)
E	E ₁	F	G NPT	G ₁ NPT
1.58 (40)	2.06 (52)	.57 (14)	.55 (14)	1.51 (38)
H	H ₁	J	K NPT	L
2.13 (54)	2.50 (64)	2.32 (59)	2.13 (54)	.60 (15)
M	M ₁ NPT	N	P	Q
1.03 (26)	.06 (2)	.50 (13)	.65 (17)	1.58 (40)
R	S	T	U	
.33 (8)	.27 (7)	3.00 (76)	.48 (11)	

Inches (mm)

Foot Valve Guard: PS2043P*

A	A ₁	B	B ₁	C
4.50 (114)	.75 (19)	10.50 (267)	1.25 (32)	.48 (11)
D	E	E ₁	F	F ₁
6.00 (152)	7.13 (181)	.50 (13)	13.00 (330)	8.38 (213)

Inches (mm)

* This kit contains the valve mounting hardware.

CAUTION:

This valve shall not be used to actuate a punch press. Do not use this valve on punch presses or press brakes. See OSHA 1910.217.

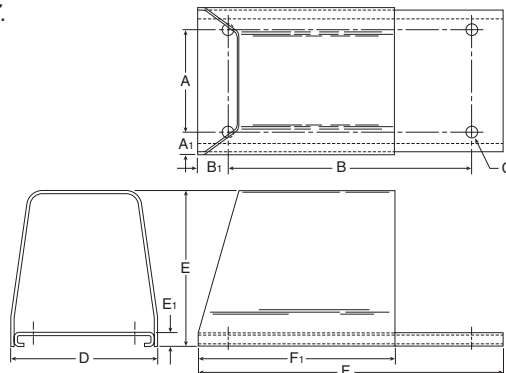

For inventory, lead times, and kit lookup, visit www.pdnplu.com

Directair 2 & 4 Series

Viking Xtreme Lever Series

42 Lever / Pedal Series

M0 Series

Safety



Manual / Mechanical Valves

Manual / Mechanical

Brass Poppet / Sliding Seal

Control Panel Products

Sensing

Features

MO Series

MO Series

- 1/4" to 3/4" NPTF ports
- Standard operators listed. Consult factor for variations in orientation
- Standard 2 position 3-way and 4-way valves listed. Consult factory for 2-way and 3 position valves
- Corrosion resistant bronze body
- High flow brass spacers position o-ring, permit reverse piping and vacuum service
- Specially compounded o-rings suitable for non-lube air service and low pressure oil service
- Floating stem of hard chrome plated stainless steel; no metal to metal contact
- Closed at crossover design for air savings
- Piped exhaust convenient for muffling
- Interchangeable operators
- Interchangeable end sections
- Service without disturbing plumbing
- Dual mounting brackets on most models

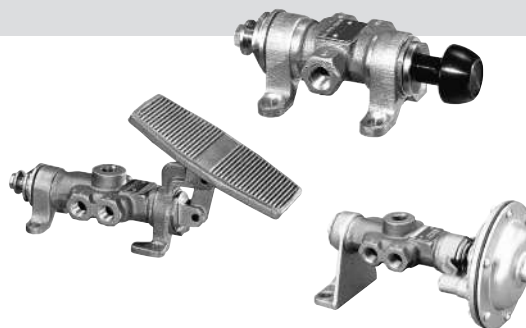

Flow Cv ratings

Valve Type	Port Size	Port 1 to 2	Port 1 to 3	Port 2 to 3	Port 2 to 4	Port 3 to 4
3-Way 2-Position	1/4	2.4	—	2.4	—	—
	3/8	3.2	—	3.4	—	—
	1/2	5.0	—	5.1	—	—
4-Way 2-Position	1/4	2.4	2.4	—	2.0	2.2
	3/8	3.4	3.2	—	3.0	3.1
	1/2	5.2	5.3	—	4.7	4.7
	3/4	8.7	9.2	—	7.9	8.0

Flow Cv

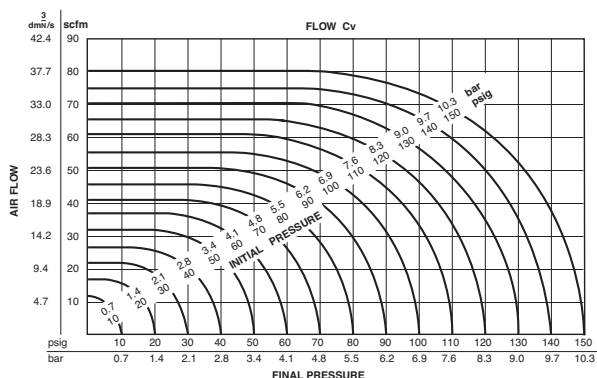

Flow capacities

The capacity curves shown in the chart are for a theoretical valve having a Cv = 1.0 for air at standard conditions.

Flow rating determined in accordance with NFPA recommended standard NFPA/T3.21.3 - 1974.

Operating information

Pressure limitations
Knob (manual and spring return) and palm operators (manual and spring return)

Media	Port size	PSI (kPa)	
		3-way	4-way
Air and Hydraulic	1/4	200 (1380)	180 (1240)
	3/8	175 (1210)	170 (1170)
	1/2	160 (1100)	150 (1030)
	3/4	150 (1030)	150 (1030)
Vacuum	All	Within 1" Hg of perfect	
Other	Consult factory		

Pressure limitations
Knob (detent), lever, pedal, treadle, clevis, cam air operated diaphragm and cylinder

Media	Port size	PSI (kPa)	
		3-way	4-way
Air and Hydraulic	1/4	225 (1550)	225 (1550)
	3/8	225 (1550)	225 (1550)
	1/2	215 (1480)	215 (1480)
	3/4	200 (1380)	200 (1380)
Vacuum	All	Within 1" Hg of perfect	
Other	Consult factory		

Temperature range: -15°F to 200°F (-26° to 93°C)

Lubrication: For best results and service life use clean, moisture free lubricated air.

Material specifications

Body	High pressure valve bronze
Knobs and palm buttons	Anodized aluminum
Operators	Iron castings; steel rod, bar and tube, and plated for corrosion resistance
O-rings	Buna-N and impregnated with Molybdenum Disulfide
Spacers and end bearings	Brass bar stock
Springs	high quality steel and plated for corrosion resistance
Stem	Stainless steel and hard chrome plated

Warnings

- ⚠ Install guards on all hand operated valves if accidental operation can cause personal injury.
- ⚠ Foot operated valves must be protected against inadvertent operation that can cause serious bodily injury. Use of a guard is strongly recommended as it will reduce the likelihood of inadvertent operation.

Directair 2 & 4 Series

Viking Xtreme Lever Series

4/2 Lever / Pedal Series

MO Series

Safety



Manual / Mechanical Valves

Brass Poppet / Sliding Seal







































Control Panel Products

Sensing



For inventory, lead times, and kit lookup, visit www.pdnplu.com

MO Series Air Pilot, Manual & Mechanically Actuated Valves

3-Way And 4-Way Knob Operated	Description	Part Number 1/4 NPT	Part Number 3/8 NPT	Part Number 1/2 NPT	Part Number 3/4 NPT
	 3-way, detent ball, foot bracket	M05422448	M05432448	M05442448	M05462448
	 3-way, detent ball, panel mount with nut	M05822451	M05832451	M05842451	M05862451
	 3-way, N.C., manual, foot bracket	M08521848	M08531848	M08541848	M08561848
	 3-way, N.C., manual, panel nut	M08521851	M08531851	M08541851	M08561851
	 3-way, N.C., pull to operate, spring return, foot bracket	M09721848	M09731848	M09741848	M09761848
	 3-way, N.C., pull to operate, spring return, panel mount with nut	M06421851	M06431851	M06441851	M06461851
	 3-way, N.C., push to operate, spring return, foot bracket	M09821848	M09831848	M09841848	M09861848
	 3-way, N.C., push to operate, spring return, panel mount with nut	M06521851	M06531851	M06541851	M06561851
	 4-way, detent ball, foot bracket	M05425448	M05435448	M05445448	M05465448
	 4-way, detent ball, panel mount with nut	M05825451	M05835451	M05845451	M05865451
	 4-way, manual, foot bracket	M08524648	M08534648	M08544648	M08564648
	 4-way, manual, panel nut	M08524651	M08534651	M08544651	M08564651
	 4-way, pull to operate, spring return, foot bracket	M09724648	M09734648	M09744648	M09764648
	 4-way, pull to operate, spring return, panel mount with nut	M06424651	M06434651	M06444651	M06464651
	 4-way, push to operate, spring return, foot bracket	M09824648	M09834648	M09844648	M09864648
	 4-way, push to operate, spring return, panel mount with nut	M06524651	M06534651	M06544651	M06564651
3-Way and 4-Way Palm Button Operated					
	 3-way, N.C., pull palm button to operate, spring return, panel mount with nut	M06421859	M06431859	M06441859	M06461859
	 3-way, N.C., push palm button to operate, spring return, panel mount with nut	M06521859	M06531859	M06541859	M06561859
	 4-way, pull palm button to operate, spring return panel mount with nut	M06424659	M06434659	M06444659	M06464659
	 4-way, push palm button to operate, spring return, panel mount with nut	M06524659	M06534659	M06544659	M06564659
3-Way and 4-Way Lever Operated					
	 3-way, detent ball, foot bracket	M05422443	M05432443	M05442443	M05462443
	 3-way, manual, foot bracket	M08521843	M08531843	M08541843	M08561843
	 3-way, N.C., pull lever to operate, spring return, foot bracket	M09621843	M09631843	M09641843	M09661843
	 3-way, N.C., push lever to operate, spring return, foot bracket	M09521843	M09531843	M09541843	M09561843
	 4-way, detent ball, foot bracket	M05425443	M05435443	M05445443	M05465443
	 4-way, manual, foot bracket	M08524643	M08534643	M08544643	M08564643
	 4-way, pull lever to operate, spring return, foot bracket	M09624643	M09634643	M09644643	M09664643
	 4-way, push lever to operate, spring return, foot bracket	M09524643	M09534643	M09544643	M09564643

Red Square = Discontinued

 Most popular.



For inventory, lead times, and kit lookup, visit www.pdnplu.com

Directair 2 & 4 Series
Viking Xtreme Lever Series
42 Lever / Pedal Series
MO Series
Safety
M
Manual / Mechanical Valves
Brass Poppet / Sliding Seal
Control Panel Products
Sensing

Common Part Numbers

MO Series

MO Series Air Pilot, Manual & Mechanically Actuated Valves

3-Way and 4-Way, Foot Operated: Treadle / Pedal Type		Part Number 1/4 NPT	Part Number 3/8 NPT	Part Number 1/2 NPT	Part Number 3/4 NPT
	3-way, treadle operated, detent ball, foot bracket	M05422488	M05432488	M05442488	—
	3-way, treadle operated, manual return, foot bracket	M08521888	M08531888	M08541888	—
	3-way, N.C., spring return, pedal operated, foot bracket	M06221840	M06231840	M06241840	—
	4-way, treadle operated, detent ball, foot bracket	M05425488	M05435488	M05445488	—
	4-way, treadle operated, manual return, foot bracket	M08524688	M08534688	M08544688	—
	4-way, spring return, pedal operated, foot bracket	M06224640	M06234640	M06244640	—

CAUTION: This valve shall not be used to actuate a punch press. Do not use this valve on punch presses or press brakes. See OSHA 1910.217.

3-Way and 4-Way Air Operated : Diaphragm or Cylinder

	3-way, N.C., single air diaphragm, air signal to actuate, spring return foot bracket	M08421830	M08431830	M08441830	—
	3-way, single air cylinder signal to actuate, spring return foot bracket	M08521826	M08531826	M08541826	M08561826
	3-way, double air diaphragm	M03321833	M03331833	M03341833	—
	3-way, double air cylinder foot bracket	M01921819	M01931819	M01941819	M01961819
	4-way, single air diaphragm, air signal to actuate, spring return foot bracket	M08424630	M08434630	M08444630	—
	4-way, single air cylinder signal to actuate, spring return foot bracket	M08524626	M08534626	M08544626	M08564626
	4-way, double air diaphragm	M03324633	M03334633	M03344633	—
	4-way, double air cylinder foot bracket	M01924619	M01934619	M01944619	M01964619

Note: diaphragm operators : pilot signal pressures from 20 to 60 psi. Cylinder operators : pilot signal pressures from 20 to 250 psi.

3-Way and 4-Way Clevis Operated

	3-way, manual, foot bracket	M08521805	M08531805	M08541805	M08561805
	3-way, N.C., pull to operate, spring return foot bracket	M09621805	M09631805	M09641805	M09661805
	3-way, N.C., push to operate, spring return, foot bracket	M09521805	M09531805	M09541805	M09561805
	4-way, manual, foot bracket	M08524605	M08534605	M08544605	M08564605
	4-way, pull clevis to operate, spring return, foot bracket	M09624605	M09634605	M09644605	M09664605
	4-way, push clevis to operate, spring return, foot bracket	M09524605	M09534605	M09544605	M09564605

3-Way and 4-Way Cam Operated

	3-way, N.C., spring return, cam operated, foot bracket	M09521803	M09531803	M09541803	M09561803
	4-way, spring return, cam operated, foot bracket	M09524603	M09534603	M09544603	M09564603

Red Square = Discontinued

Most popular.



For inventory, lead times, and kit lookup, visit www.pdnplu.com

Directair 2 & 4 Series

Viking Xtreme Lever Series

4/2 Lever / Pedal Series

MO Series

Safety



Manual / Mechanical Valves

Brass Poppet / Sliding Seal

Control Panel Products

Sensing

MO Valve: 1/4", 3/8", 1/2" Port Size

MO 85 3 18 48

Valve Series	
Basic Series	MO

Left End Section	
Double Cylinder	19
Double Air Diaphragm	33
Ball Detent, Small Bracket	54
Ball Detent, Panel Mounted	58
Direct Acting Spring Return, Less Bracket (Push Lever)	62
Reverse Acting Spring Return, Less Bracket (Pull Lever)	63
Light Spring Return Direct Acting, Less Bracket (Pull Knob)	64
Light Spring Return Reverse Acting, Less Bracket (Push Knob)	65
Stem Stop, Large Bracket	84
Stem Stop, Small Bracket	85
Direct Acting Spring Return, Small Bracket (Push Lever)	95
Reverse Acting Spring Return, Small Bracket (Pull Lever)	96
Light Spring Return Direct Acting, Small Bracket (Pull Knob)	97
Light Spring Return Reverse Acting, Small Bracket (Push Knob)	98

Operating End Section: Right End	
03	Cam Follower
05	Clevis, Small Bracket
19	Double Cylinder
26	Single Cylinder
30	Single Diaphragm, Std. Spring
33	Double Diaphragm
40	Pedal
43	Lever, Mounting Feet
48	Knob, Small Bracket
51	Knob, Panel Mounted
59	Palm Button, Panel Mounted
88	Treadle
99	Palm Button

Body / Function	
18	3-Way
24*	3-Way, 2-Position Detent
46	4-Way
54*	4-Way, 2-Position Detent

* At least one end section must be coded 54.

Pipe Size	
NPT	Port Size
1/4	2
3/8	3
1/2	4

MO Valve: 3/4" Port Size

MO 85 6 18 48

Valve Series	
Basic Series	MO

Left End Section	
Double Cylinder	19
Ball Detent, Small Bracket	54
Ball Detent, Panel Mounted	58
Direct Acting Spring Return, Less Bracket (Push Lever)	62
Reverse Acting Spring Return, Less Bracket (Pull Lever)	63
Light Spring Return Direct Acting, Less Bracket (Pull Knob)	64
Light Spring Return Reverse Acting, Less Bracket (Push Knob)	65
Stem Stop, Small Bracket	85
Direct Acting Spring Return, Small Bracket (Push Lever)	95
Reverse Acting Spring Return, Small Bracket (Pull Lever)	96
Light Spring Return Direct Acting, Small Bracket (Pull Knob)	97
Light Spring Return Reverse Acting, Small Bracket (Push Knob)	98

Operating End Section: Right End	
03	Cam Follower
05	Clevis, Small Bracket
19	Double Cylinder
26	Single Cylinder
43	Lever, Mounting Feet
48	Knob, Small Bracket
51	Knob, Panel Mounted
59	Palm Button, Panel Mounted
99	Palm Button

Body / Function	
18	3-Way
24*	3-Way, 2-Position Detent
46	4-Way
54*	4-Way, 2-Position Detent

* At least one end section must be coded 54.

Pipe Size	
NPT	Port Size
3/4	6



CAUTION:

Be sure to order end sections that are functionally effective with each other and with the body section selected. Model number combinations are possible which may not operate.



For inventory, lead times, and kit lookup, visit www.pdnplu.com

Directair 2 & 4 Series
Viking Xtreme Lever Series
42 Lever / Pedal Series
MO Series
Safety
M
Manual / Mechanical Valves
Brass Poppet / Sliding Seal
Control Panel Products
Sensing

Accessories

**Pedal Guard
(Fits All Pedal Operated Valves)**

Description	Model number
Guard with door	M232001
Guard without door	M232002
Guard with door for 1/4 and 3/8 valve	M232003*
Guard without door for 1/4 and 3/8 valve	M232004*
Guard with door for 1/2 and 3/4	M232005*
Guard without door for 1/2 and 3/4	M232006*

* Includes mounting hardware.

CAUTION:

Foot valves utilizing this guard shall not be used to actuate a punch press.
Do not use this valve on punch presses or press brakes.
See OSHA 1910.217.

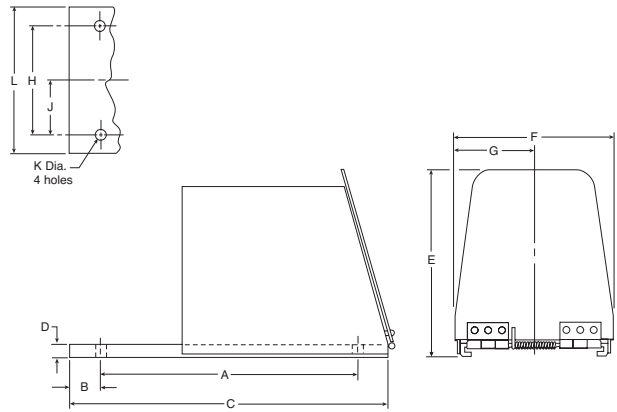

Dimensions

A	B	C	D	E	F	G
10.50	1.25	13.00	.50	7.38	6.36	3.18
266.7	31.8	330.2	12.7	187.4	161.5	80.8
H	J	K	L			
4.50	2.25	.44	6.00			
114.3	57.2	11.2	152.4			

MO valve 9 digit part number dissection

The MO Valve Series has with wide variety of operating and return ends which can be ordered either on the left or right hand side of the valve body. Common part numbers on the previous pages can be ordered with the left and right hand ends swapped. Swapping operator and return end sections does not change the spool function, but can reverse the

expected function of the valve. For example, a 3-way, normally closed, "NC", spring return valve will become a 3-way normally open, "NO", valve when the operator and return section is swapped. There are other non-cataloged options available and this part number dissection will enable you to discuss your valve part number with the factory for options.

3-way

Series name	Left end	Port size	Body function	Right end
MO	XX	X	XX	XX

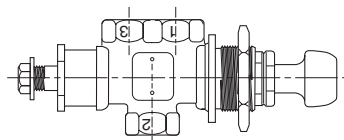

Left End Section in relation to port #2 ← → Right End Section in relation to port #2

4-way

Series name	Left end	Port size	Body function	Right end
MO	XX	X	XX	XX

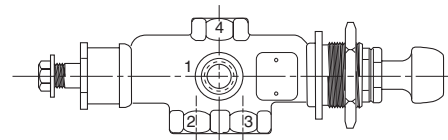

Left End Section in relation to port #2 ← → Right End Section in relation to port #3

Most popular.

Red Square = Discontinued



For inventory, lead times, and kit lookup, visit www.pdnplu.com

Body Sections

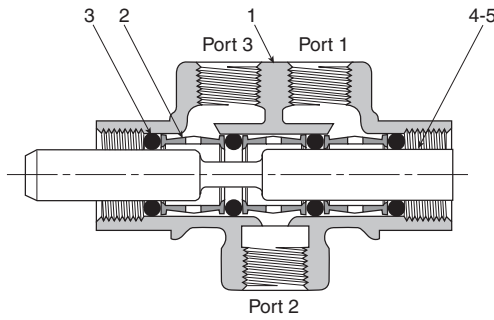

M032*18
Standard 3-Way
M032*24
2-Position Detent 3-Way

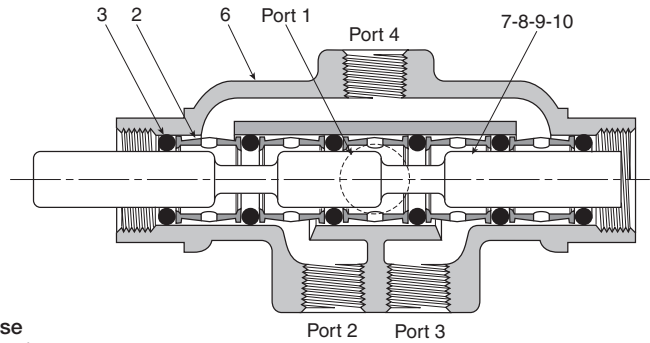

M032*46
Standard 4-Way
M032*54
2-Position Detent 4-Way

Port Size	Use No. *
1/4	2
3/8	3
1/2	4
3/4	6

Item No.	Part Number				Description
	1/4"	3/8"	1/2"	3/4"	
1	M053007	M053019	M053030	M053038	Body – 3-Way
2	M313004	M313011	M313013	M313017	Spacer (2-3-5)
3	H13466	H13588	H13580	H13584	O-Ring (3-4-6)
4	M373014	M373060	M373102	M373142	Stem – 3-Way
5	M373020	M373064	M373103	M373146	Stem – 3-Way 2-Pos. Detent
6	M053003	M053020	M053033	M053039	Body – 4-Way
7	M373033	M373074	M373116	M373156	Stem – 4-Way
8	M373039	M373076	M373118	—	Stem – 4-Way 2-Pos. Detent

NOTE: () denotes quantity required when more than one.

Service Kits

(Field service instructions)

Description (For all 3 & 4-way valves)	1/4	3/8	1/2	3/4
Manual & mechanical operators	M242001	M242002	M242003	M242004
Cylinder (single, double & double-acting)	M242006	M242007	M242008	M242009
Diaphragm (single & double)	M242011	M242012	M242013	M242014

Replacement Knobs & Palm Buttons



Knob & Adapter Kit Palm Button & Adapter Kit

Description	1/4" & 3/8"	1/2"	3/4"
Knob & Adapter Kit	M122001	M122002	M122003
Palm Button & Adapter Kit	M122004	M122005	M122006

Hex Drive Pipe Plugs

Port Size	1/4"	3/8"	1/2"	3/4"
Part Number	K21R02025L	K21R02037L	K21R02050L	K21R02075L

Red Square = Discontinued



For inventory, lead times, and kit lookup, visit www.pdnplu.com

Directair 2 & 4 Series
 Viking Xtreme Lever Series
 42 Lever / Pedal Series
 MO Series
 Safety
 Manual / Mechanical Valves
 Brass Poppet / Sliding Seal
 Control Panel Products
 Sensing

Manual & Mechanical Operators

Directair 2 & 4 Series
 Viking Xtreme Lever Series
 42 Lever / Pedal Series
 MO Series
 Safety
 Manual / Mechanical Valves
 Brass Poppet / Sliding Seal
 Control Panel Products
 Sensing

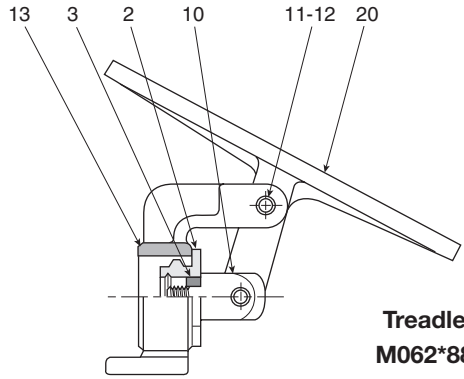

**Treadle
 M062*88**

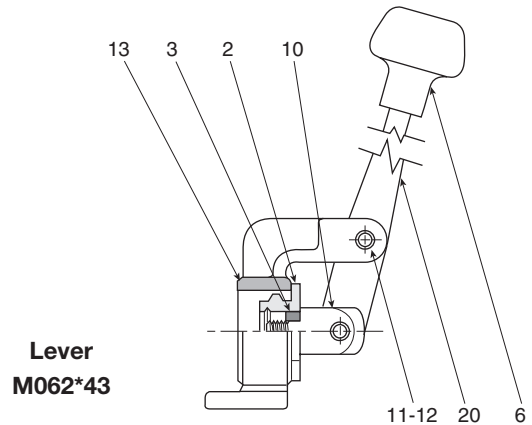

**Lever
 M062*43**

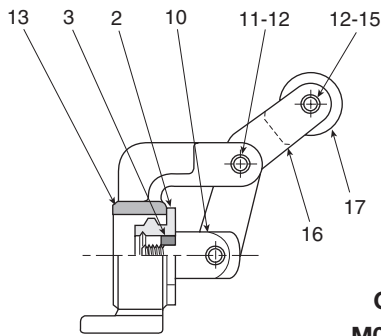

**Cam
 M062*03**

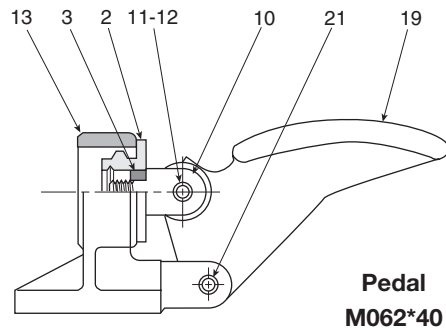

**Pedal
 M062*40**

Port Size	Use No. *
1/4	2
3/8	3
1/2	4
3/4	6

Item No.	Part Number				Description
	1/4"	3/8"	1/2"	3/4"	
2	M103012	M103047	M103066	M103108	End Bearing
3	H17705	H17705	H17706	H17408	Lockwasher
6	H05028	H05028	H05028	H05028	Knob
10	M133003	M133003	M133012	M133018	Clevis
11	H07229	H07229	M333013	M333013	Pivot Pin (2)
12	—	—	H08903	H08903	Retaining Ring (4)
13	M073009	M073022	M073033	M073042	Bracket
14	M273022	M273022	M273023	M273024	Lever
15	—	H07230	M333016	M333016	Roller Trunnion
16	M273002	M273002	M273006	M273007	Cam Arm
17	M443003	M443003	M443002	M443002	Roller
19	M323005	M323005	M323006	M323007	Pedal
20	M553004	M553004	M553005	—	Treadle
21	H07229	H07229	M333013	M333014	Pivot Pin

NOTE: () denotes quantity required when more than one.

Red Square = Discontinued



For inventory, lead times, and kit lookup, visit www.pdnplu.com

Manual & Mechanical Operators

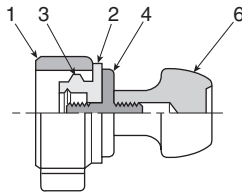

Knob
M062*48

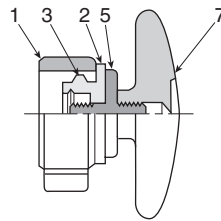

Palm Button
M062*99

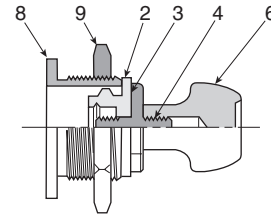

Panel Mounted Knob
M062*51

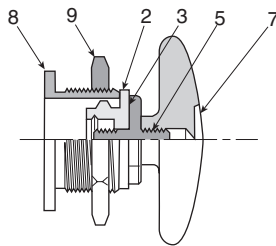

Panel Mounted Palm Button
M062*59

Port Size	Use No. *
1/4	2
3/8	3
1/2	4
3/4	6

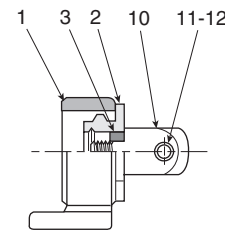

Clevis
M062*05

Item No.	Part Number				Description
	1/4"	3/8"	1/2"	3/4"	
1	M073016	M073026	M073037	M073046	Bracket
2	M103012	M103047	M103066	M103108	End Bearing
3	H17705	H17705	H17706	H17408	Lockwasher
4	M013011	M013011	M013012	M013013	Knob Adapter
5	M013011	M013011	M013012	M013013	Palm Knob Adapter
6	H05028	H05028	H05028	H05028	Knob
7	H05029	H05029	H05029	H05029	Palm Button
8	M013014	M013015	M013016	M013017	Panel Adapter
9	M303005	M303006	M303007	M303008	Jam Nut
10	M133003	M133003	M133012	M133018	Clevis
11	H07229	H07229	M333013	M333013	Pivot Pin (2)
12	—	—	H08903	H08903	Retaining Ring (4)

NOTE: () denotes quantity required when more than one.

Red Square = Discontinued



For inventory, lead times, and kit lookup, visit www.pdnplu.com

Directair 2
& 4 Series

Viking Xtreme
Lever Series

42 Lever/
Pedal Series

MO Series

Safety



Manual / Mechanical
Valves

Brass Poppet /
Sliding Seal

Control Panel
Products

Sensing

Pneumatic Operators

Directair 2 & 4 Series
 Viking Xtreme Lever Series
 42 Lever / Pedal Series
 MO Series
 Safety
 Manual / Mechanical Valves
 Brass Poppet / Sliding Seal
 Control Panel Products
 Sensing

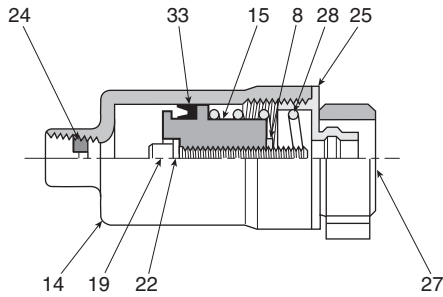

**Single Cylinder
 M062*26**

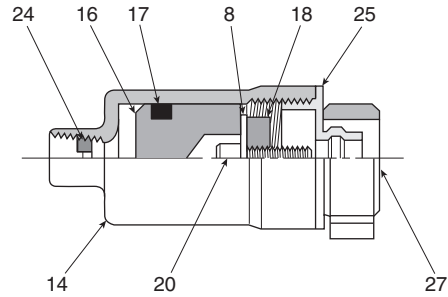

**Double Cylinder
 M062*19**

Port Size	Use No. *
1/4	2
3/8	3
1/2	4
3/4	6

Item No.	Part Number				Description
	1/4"	3/8"	1/2"	3/4"	
8	H17705	H17705	H17706	H17408	Lockwasher
14	M243028	M243028	M243028	M243036	Housing
15	M343019	M343019	M343018	M343027	Piston – Single Act.
16	M343022	M343022	M343022	M343028	Piston – Double Cyl.
17	H14515	H14515	H14515	H14520	Packer
18	M013005	M013005	M013007	M013009	Adapter
19	H10121	H10121	H10147	H10219	Screw – Single Act.
20	H10117	H10117	H10145	H10215	Screw – Double Act.
22	H17514	H17514	H17519	H17524	Lockwasher
24	M363002	M363002	M363002	M363002	Restrictor
25	M383007	M383011	M383018	M383029	Retainer
27	M073016	M073026	M073037	M073046	Bracket
28	M493015	M493015	M493015	M493020	Spring
33	H22232	H22232	H22232	H14520	Packer

NOTE: () denotes quantity required when more than one.

Red Square = Discontinued



For inventory, lead times, and kit lookup, visit www.pdnplu.com

Pneumatic Operators

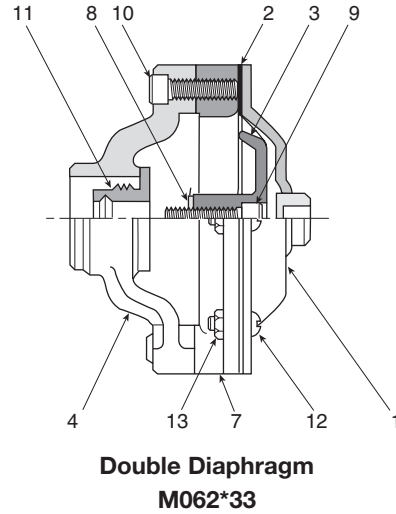
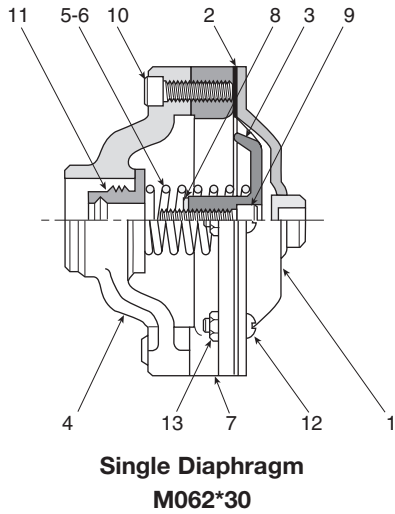

Port Size	Use No. *
1/4	2
3/8	3
1/2	4
3/4	6

Item No.	Part Number				Description
	1/4"	3/8"	1/2"	3/4"	
1	M163005	M163005	M163005	M163012	Cover
2	M193002	M193002	M193002	M193005	Diaphragm
3	M343038	M343038	M343032	M343039	Piston
4	M573004	M573003	M573001	M573011	Yoke
5	M493024	M493024	M493010	M493023	Spring
6	M493022	M493022	M493009	—	Spring (Inst. Air)
7	M423002	M423002	M423002	M423004	Ring
8	H17705	H17705	H17706	H17408	Lockwasher
9	H10119	H10119	H10145	H10217	Screw
10	H10115	H10115	H10115	H10115	Screw (2)
11	M103012	M103047	M103066	M103108	End Bearing
12	H11333	H11333	H11333	H11333	Screw (6)
13	H06416	H06416	H06416	H06416	Nut (6)

NOTE: () denotes quantity required when more than one.

Red Square = Discontinued



For inventory, lead times, and kit lookup, visit www.pdnplu.com

Directair 2 & 4 Series
 Viking Xtreme Lever Series
 42 Lever / Pedal Series
 MO Series
 Safety
M
 Manual / Mechanical Valves
 Brass Poppet / Sliding Seal
 Control Panel Products
 Sensing

End Sections

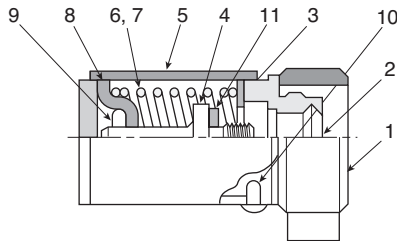

Direct Acting Spring Return with Bracket
M062*95 Push Lever
M062*97 Pull Knob

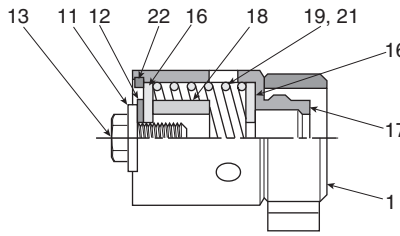

Spring Centered Neutral
M062*74 Standard Spring
M062*78 Heavy Spring

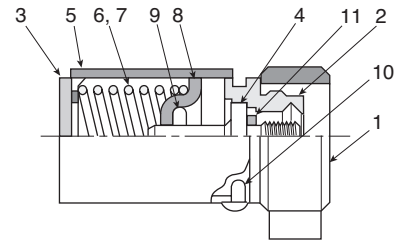

Reverse Acting Spring Return with Bracket
M062*96 Pull Lever
M062*98 Push Knob

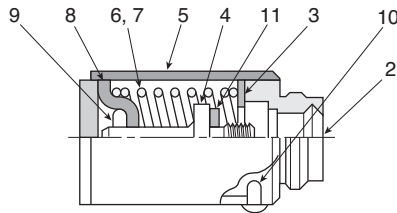

Direct Acting Spring Return Less Bracket
M062*62 Push Lever
M062*64 Pull Knob

Port Size	Use No. *
1/4	2
3/8	3
1/2	4
3/4	6

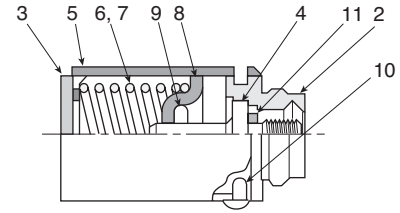

Reverse Acting Spring Return Less Bracket
M062*63 Pull Lever
M062*65 Push Knob

Item No.	Part Number				Description
	1/4"	3/8"	1/2"	3/4"	
1	M073016	M073026	M073037	M073046	Bracket
2	M103111	M103112	M103113	M103114	End Bearing
3	M413015	M413015	M413016	M413017	Spring Retainer Washer
4	M523009	M523009	M523010	M523011	Stem Stop – Guide
5	M243043	M243043	M243044	M243045	Spring Housing
6	M493037	M493037	M493027	M493026	Spring – Knob Oper.
7	M493038	M493038	M493011	M493012	Spring – Other Oper.
8	M383032	M383032	M383033	M383034	Spring Retainer
9	H07254	H07254	H07270	H07271	Roll Pin
10	H11215	H11215	H11216	H11217	Screw
11	H17705	H17705	H17706	H17408	Lockwasher
12	M563002	M563002	M563006	M563014	Stem Stop
13	H09626	H09626	H09645	H09706	Stem Stop Screw
16	M563007	M563009	M563008	M563016	Washer
17	M243008	M243019	M243027	M243032	Spring Housing
18	M083003	M083004	M083005	M083008	Spacer
19	M493008	M493008	M493008	M493014	Spring
21	M493006	M493006	M493006	M493007	Spring – Dbl. Act. Cyl.
22	H09025	H09025	H09025	H09012	Retainer Ring

Red Square = Discontinued

NOTE: () denotes quantity required when more than one.



For inventory, lead times, and kit lookup, visit www.pdnplu.com

Directair 2 & 4 Series

Viking Xtreme Lever Series

42 Lever / Pedal Series

MO Series

Safety



Manual / Mechanical Valves

Brass Poppet / Sliding Seal

Control Panel Products

Sensing

End Sections

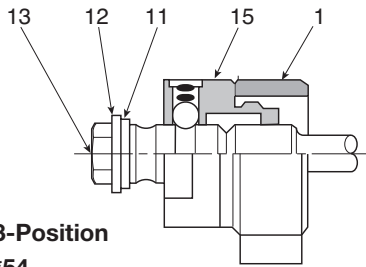

**Ball Detent, 3-Position
M062*54**

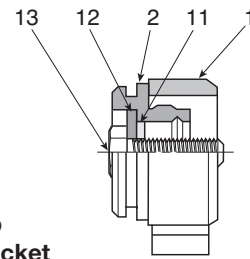

**Stem Stop
with Small Bracket
M062*85**

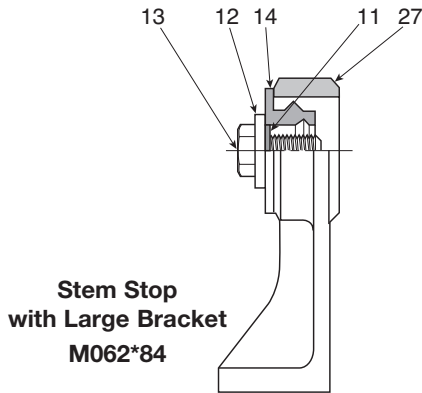

**Stem Stop
with Large Bracket
M062*84**

Port Size	Use No. *
1/4	2
3/8	3
1/2	4
3/4	6

Item No.	Part Number				Description
	1/4"	3/8"	1/2"	3/4"	
1	M073016	M073026	M073037	M073046	Bracket
2	M103111	M103112	M103113	M103114	End Bearing
11	H17705	H17705	H17706	H17408	Lockwasher
12	M563002	M563002	M563006	M563014	Stem Stop
13	H09626	H09626	H09645	H09706	Stem Stop Screw
14	M103012	M103047	M103066	M103108	End Bearing – Plain
15	M012001	M012002	M012003	M012005	Ball Detent Assembly
27	M073006	M073017	M073028	—	Large Bracket

NOTE: () denotes quantity required when more than one.

Directair 2 & 4 Series
Viking Xtreme Lever Series
42 Lever / Pedal Series
MO Series
Safety
Manual / Mechanical Valves
Brass Poppet / Sliding Seal
Control Panel Products
Sensing



For inventory, lead times, and kit lookup, visit www.pdnplu.com

Knob Operated, 2-Position Detent, Ball Detent

M054 Ball Detent, Small Bracket & M058 Ball Detent, Panel Mounted

3-Way

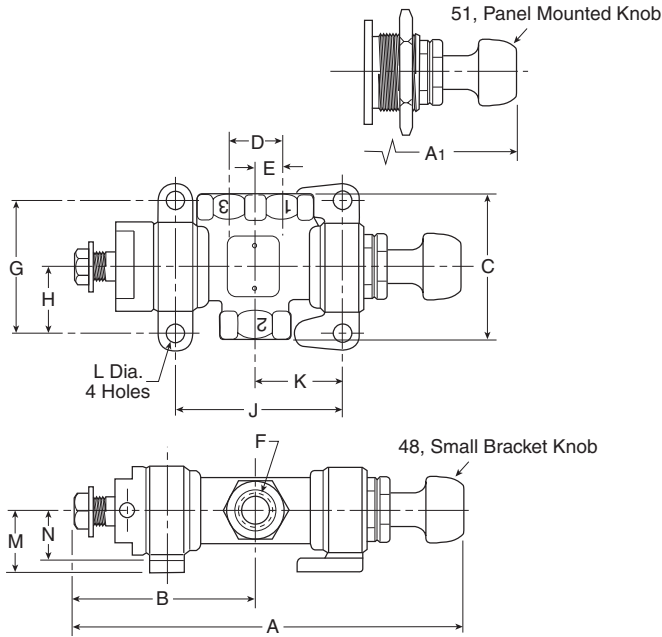

	1/4	3/8	1/2	3/4
A	6.57 (166.9)	7.30 (185.4)	8.56 (217.4)	10.40 (264.2)
A1	6.57 (166.9)	7.30 (185.4)	8.56 (217.4)	10.40 (264.2)
B	3.25 (82.6)	3.66 (93.0)	4.39 (111.5)	5.41 (137.4)
C	2.38 (60.4)	2.62 (66.6)	3.00 (76.2)	3.62 (92.0)
D	.94 (23.9)	1.06 (26.9)	1.25 (31.8)	1.62 (41.2)
E	.47 (11.9)	.53 (13.5)	.62 (15.8)	.81 (20.6)
F	1/4" Pipe	3/8" Pipe	1/2" Pipe	3/4" Pipe
G	2.25 (57.2)	2.38 (60.4)	2.62 (66.6)	3.25 (82.6)
H	1.12 (28.4)	1.19 (30.2)	1.31 (33.3)	1.62 (41.2)
J	2.63 (66.8)	3.13 (79.5)	3.72 (94.5)	4.56 (115.8)
K	1.31 (33.3)	1.56 (39.6)	1.86 (47.2)	2.28 (57.9)
L	.34 (8.6)	.34 (8.6)	.41 (10.4)	.41 (10.4)
M	1.12 (28.4)	1.12 (28.4)	1.25 (31.8)	1.56 (39.6)
N	.25 (6.4)	.25 (6.4)	.31 (7.9)	.31 (7.9)

Inches (mm)

M054 Ball Detent, Small Bracket & M058 Ball Detent, Panel Mounted

4-Way

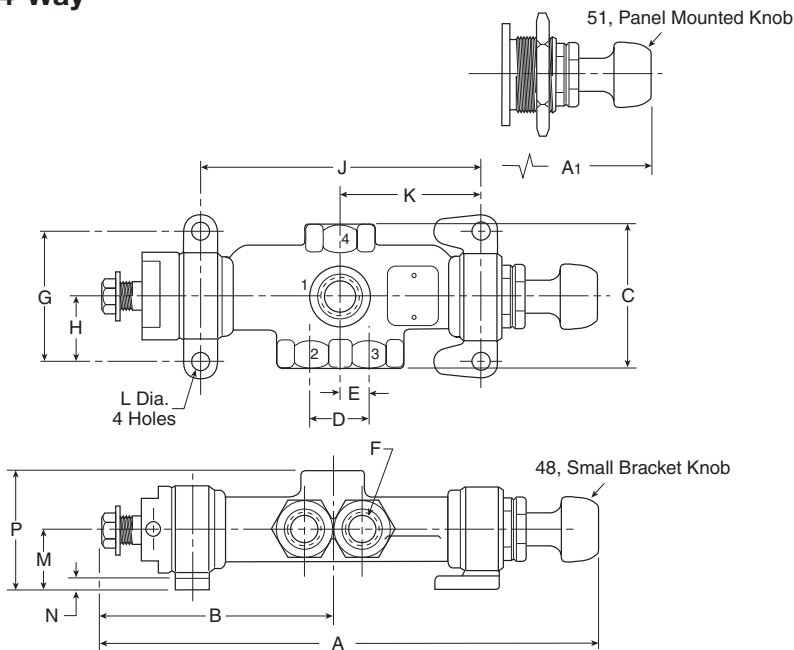

	1/4	3/8	1/2	3/4
A	8.02 (203.7)	9.13 (231.9)	11.17 (283.7)	13.10 (332.7)
A1	8.02 (203.7)	9.13 (231.9)	11.17 (283.7)	13.10 (332.7)
B	4.00 (101.6)	4.57 (116.1)	5.44 (138.2)	6.76 (171.7)
C	2.38 (60.4)	2.62 (66.6)	3.00 (76.2)	3.62 (92.0)
D	.94 (23.9)	1.06 (26.9)	1.25 (31.8)	1.62 (41.2)
E	.47 (11.9)	.53 (13.5)	.62 (15.8)	.81 (20.6)
F	1/4" Pipe	3/8" Pipe	1/2" Pipe	3/4" Pipe
G	2.25 (57.2)	2.38 (60.4)	2.62 (66.6)	3.25 (82.6)
H	1.12 (28.4)	1.19 (30.2)	1.31 (33.3)	1.62 (41.2)
J	4.14 (105.2)	4.98 (126.5)	5.85 (148.6)	7.39 (187.7)
K	2.07 (52.6)	2.49 (63.2)	2.92 (74.2)	3.69 (93.7)
L	.34 (8.6)	.34 (8.6)	.41 (10.4)	.41 (10.4)
M	1.12 (28.4)	1.12 (28.4)	1.25 (31.8)	1.56 (39.6)
N	.25 (6.4)	.25 (6.4)	.31 (7.9)	.31 (7.9)
P	2.12 (53.8)	2.18 (55.4)	2.63 (66.8)	3.06 (77.7)

Inches (mm)



For inventory, lead times, and kit lookup, visit www.pdnplu.com

Knob Operated, Manual Return, Stem Stop

M085 Stem Stop, Small Bracket

3-Way

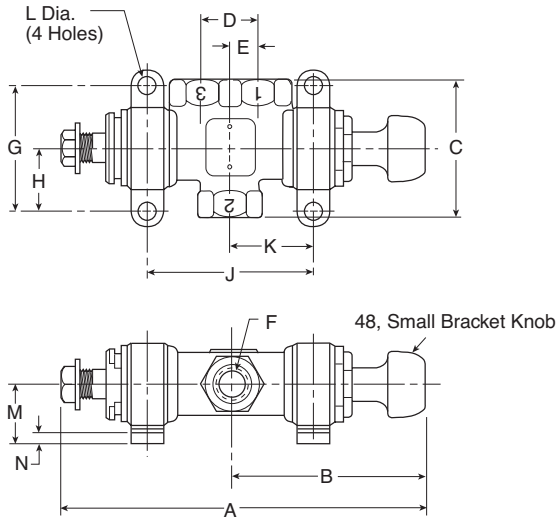

	1/4	3/8	1/2	3/4
A	5.99 (152.2)	6.69 (169.9)	7.90 (200.7)	9.60 (243.8)
B	3.32 (84.3)	3.64 (92.5)	4.17 (105.9)	4.99 (126.8)
C	2.38 (60.4)	2.62 (66.6)	3.00 (76.2)	3.62 (92.0)
D	0.94 (23.9)	1.06 (26.9)	1.25 (31.8)	1.62 (41.2)
E	0.47 (11.9)	0.53 (13.5)	0.62 (15.8)	0.81 (20.6)
F	1/4" Pipe	3/8" Pipe	1/2" Pipe	3/4" Pipe
G	2.25 (57.2)	2.38 (60.4)	2.62 (66.6)	3.25 (82.6)
H	1.12 (28.4)	1.19 (30.2)	1.31 (33.3)	1.62 (41.2)
J	2.64 (67.1)	3.14 (79.8)	3.73 (94.7)	4.67 (118.6)
K	1.32 (33.5)	1.57 (39.9)	1.87 (47.5)	2.33 (59.2)
L	0.34 (8.6)	0.34 (8.6)	0.41 (10.4)	0.41 (10.4)
M	1.12 (28.4)	1.12 (28.4)	1.25 (31.8)	1.56 (39.6)
N	0.25 (6.4)	0.25 (6.4)	0.31 (7.9)	0.31 (7.9)
Travel	0.62 (15.7)	0.69 (17.5)	0.88 (22.4)	1.12 (28.4)

Inches (mm)

M085 Stem Stop, Small Bracket

4-Way

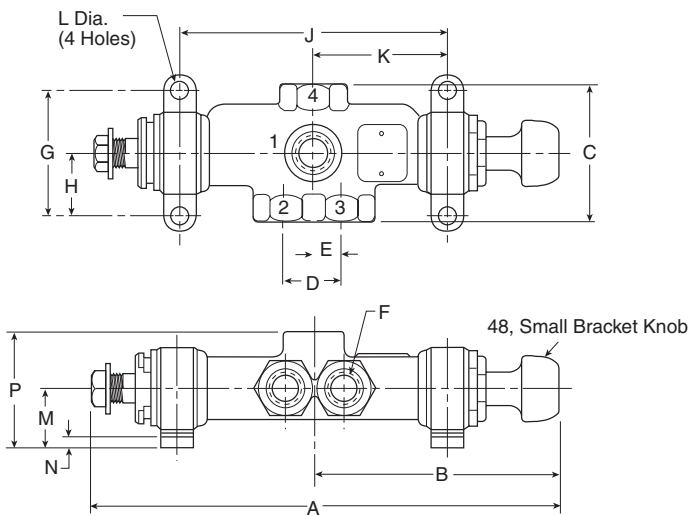

	1/4	3/8	1/2	3/4
A	7.49 (190.2)	8.53 (216.7)	10.01 (254.2)	12.31 (312.7)
B	4.02 (102.1)	4.56 (115.8)	5.73 (145.5)	6.34 (161.0)
C	2.38 (60.4)	2.62 (66.6)	3.12 (79.2)	3.62 (92.0)
D	0.94 (23.9)	1.06 (26.9)	1.25 (31.8)	1.62 (41.2)
E	0.47 (11.9)	0.53 (13.5)	0.62 (15.8)	0.81 (20.6)
F	1/4" Pipe	3/8" Pipe	1/2" Pipe	3/4" Pipe
G	2.25 (57.2)	2.38 (60.4)	2.62 (66.6)	3.25 (82.6)
H	1.12 (28.4)	1.19 (30.2)	1.31 (33.3)	1.62 (41.2)
J	4.14 (105.2)	4.98 (126.5)	5.85 (148.6)	7.39 (187.7)
K	2.07 (52.6)	2.49 (63.2)	2.93 (74.4)	3.69 (93.7)
L	0.34 (8.6)	0.34 (8.6)	0.41 (10.4)	0.41 (10.4)
M	1.12 (28.4)	1.12 (28.4)	1.25 (31.8)	1.56 (39.6)
N	0.25 (6.4)	0.25 (6.4)	0.31 (7.9)	0.31 (7.9)
P	2.12 (53.8)	2.18 (55.4)	2.63 (66.8)	3.06 (77.7)
Travel	0.62 (15.7)	0.69 (17.5)	0.88 (22.4)	1.12 (28.4)

Inches (mm)

Dimensional Data

MO Series

Knob & Palm Button Operated, Light Spring Return

M097 Light Spring Return Direct Acting, Small Bracket (Pull Knob)

3-Way

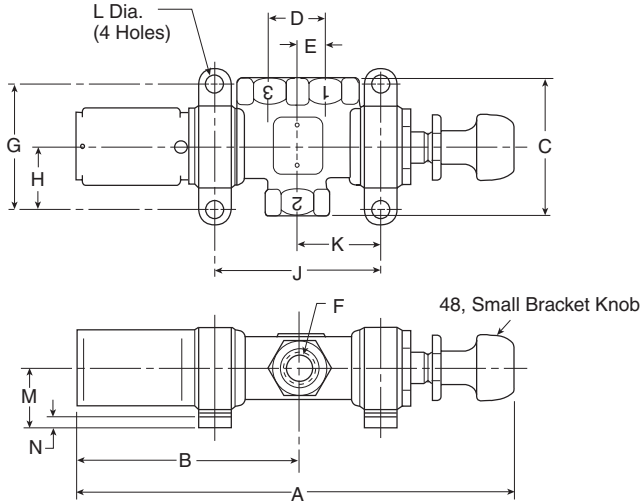

	1/4	3/8	1/2	3/4
A	7.86 (199.8)	8.55 (217.2)	10.36 (263.1)	13.01 (330.4)
B	3.92 (99.6)	4.24 (107.7)	5.32 (135.2)	6.92 (175.8)
C	2.38 (60.4)	2.62 (66.6)	3.00 (76.2)	3.62 (92.0)
D	0.94 (23.9)	1.06 (26.9)	1.25 (31.8)	1.62 (41.2)
E	0.47 (11.9)	0.53 (13.5)	0.62 (15.8)	0.81 (20.6)
F	1/4" Pipe	3/8" Pipe	1/2" Pipe	3/4" Pipe
G	2.25 (57.2)	2.38 (60.4)	2.62 (66.6)	3.25 (82.6)
H	1.12 (28.4)	1.19 (30.2)	1.31 (33.3)	1.62 (41.2)
J	2.64 (67.1)	3.14 (79.8)	3.73 (94.7)	4.67 (118.6)
K	1.32 (33.5)	1.57 (39.9)	1.87 (47.5)	2.33 (59.2)
L	0.34 (8.6)	0.34 (8.6)	0.41 (10.4)	0.41 (10.4)
M	1.12 (28.4)	1.12 (28.4)	1.25 (31.8)	1.56 (39.6)
N	0.25 (6.4)	0.25 (6.4)	0.31 (7.9)	0.31 (7.9)
Travel	0.62 (15.7)	0.69 (17.5)	0.88 (22.4)	1.12 (28.4)

Inches (mm)

M097 Light Spring Return Direct Acting, Small Bracket (Pull Knob)

4-Way

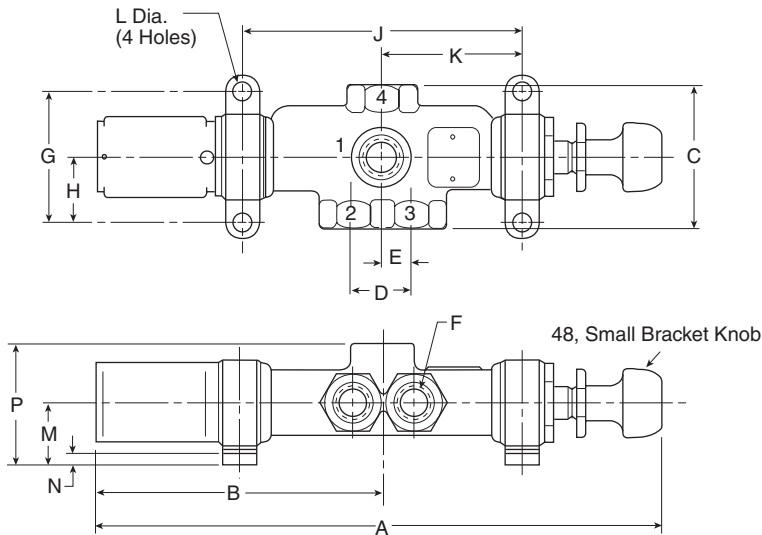

	1/4	3/8	1/2	3/4
A	9.36 (237.9)	10.39 (263.9)	12.48 (317.0)	15.73 (399.5)
B	4.67 (118.5)	5.15 (130.8)	6.37 (161.8)	8.27 (210.1)
C	2.38 (60.4)	2.62 (66.6)	3.12 (79.2)	3.62 (92.0)
D	0.94 (23.9)	1.06 (26.9)	1.25 (31.8)	1.62 (41.2)
E	0.47 (11.9)	0.53 (13.5)	0.62 (15.8)	0.81 (20.6)
F	1/4" Pipe	3/8" Pipe	1/2" Pipe	3/4" Pipe
G	2.25 (57.2)	2.38 (60.4)	2.62 (66.6)	3.25 (82.6)
H	1.12 (28.4)	1.19 (30.2)	1.31 (33.3)	1.62 (41.2)
J	4.14 (105.2)	4.98 (126.5)	5.85 (148.6)	7.39 (187.7)
K	2.07 (52.6)	2.49 (63.2)	2.93 (74.4)	3.69 (93.7)
L	0.34 (8.6)	0.34 (8.6)	0.41 (10.4)	0.41 (10.4)
M	1.12 (28.4)	1.12 (28.4)	1.25 (31.8)	1.56 (39.6)
N	0.25 (6.4)	0.25 (6.4)	0.31 (7.9)	0.31 (7.9)
P	2.12 (53.8)	2.18 (55.4)	2.63 (66.8)	3.06 (77.7)
Travel	0.62 (15.7)	0.69 (17.5)	0.88 (22.4)	1.12 (28.4)

Inches (mm)



For inventory, lead times, and kit lookup, visit www.pdnplu.com

**Panel Mounted, Knob & Button Operated,
 Light Spring Return**

**M064 Direct Acting, Less Bracket (Pull Knob) &
 M065 Reverse Acting, Less Bracket (Push Knob)**

3-Way

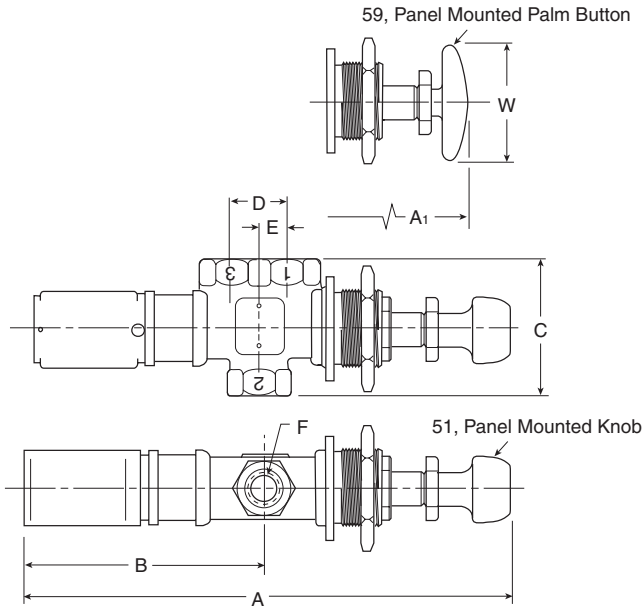

	1/4	3/8	1/2	3/4
A	7.86 (199.6)	8.55 (217.1)	10.36 (263.1)	13.01 (330.4)
A1	7.55 (191.8)	8.24 (209.3)	10.05 (255.3)	12.70 (322.6)
B	3.96 (99.5)	4.23 (107.4)	5.31 (134.9)	6.91 (175.5)
C	2.38 (60.4)	2.62 (66.6)	3.00 (76.2)	3.62 (92.0)
D	0.94 (23.9)	1.06 (26.9)	1.25 (31.8)	1.62 (41.2)
E	0.47 (11.9)	0.53 (13.5)	0.62 (15.8)	0.81 (20.6)
F	1/4" Pipe	3/8" Pipe	1/2" Pipe	3/4" Pipe
W	2.25 (57.2)	2.25 (57.2)	2.25 (57.2)	2.25 (57.2)
Travel	0.62 (15.7)	0.69 (17.5)	0.88 (22.4)	1.12 (28.4)

Inches (mm)

**M064 Direct Acting, Less Bracket (Pull Knob) &
 M065 Reverse Acting, Less Bracket (Push Knob)**

4-Way

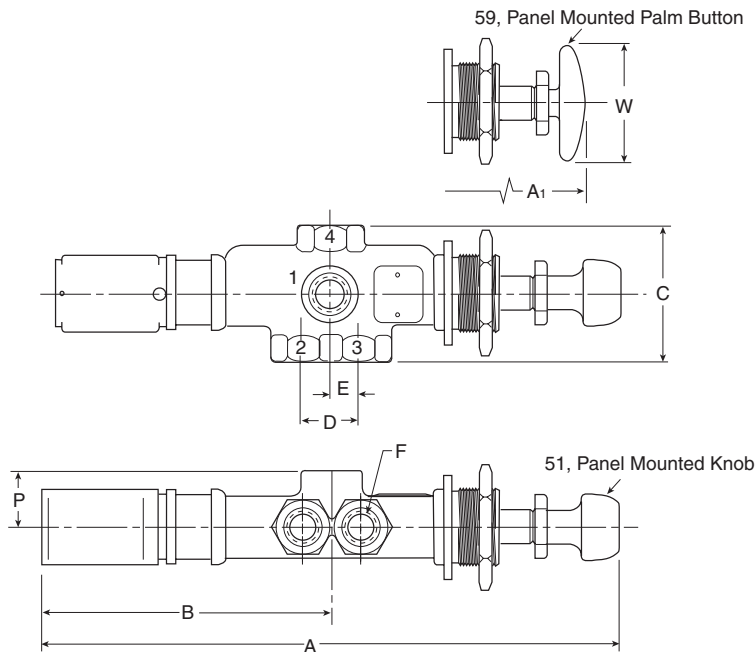

	1/4	3/8	1/2	3/4
A	9.36 (237.7)	10.39 (263.9)	12.48 (317.0)	15.73 (399.5)
A1	9.05 (229.9)	10.08 (256.0)	12.17 (309.1)	15.42 (391.7)
B	4.67 (118.5)	5.15 (130.8)	6.37 (161.8)	8.27 (210.1)
C	2.38 (60.4)	2.62 (66.6)	3.12 (79.2)	3.62 (92.0)
D	0.94 (23.9)	1.06 (26.9)	1.25 (31.8)	1.62 (41.2)
E	0.47 (11.9)	0.53 (13.5)	0.62 (15.8)	0.81 (20.6)
F	1/4" Pipe	3/8" Pipe	1/2" Pipe	3/4" Pipe
P	2.12 (53.8)	2.18 (55.4)	2.63 (66.8)	3.06 (77.7)
W	2.25 (57.2)	2.25 (57.2)	2.25 (57.2)	2.25 (57.2)
Travel	0.62 (15.7)	0.69 (17.5)	0.88 (22.4)	1.12 (28.4)

Inches (mm)

Dimensional Data

Lever Operated, Manual Return, Stem Stop

M085 Stem Stop, Small Bracket

3-Way

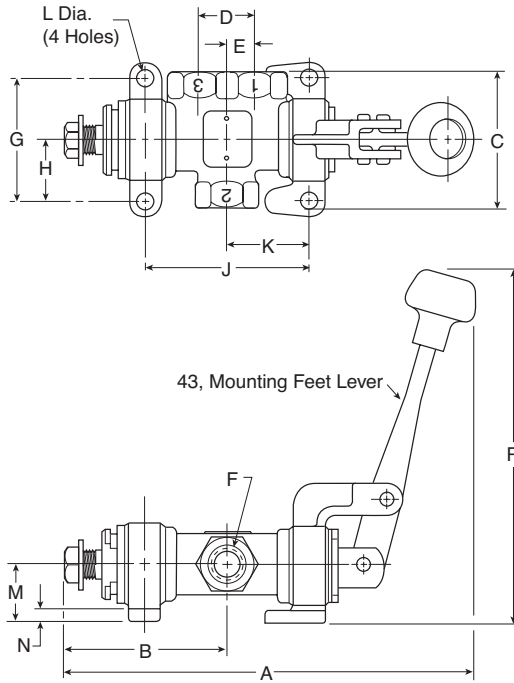

	1/4	3/8	1/2	3/4
A	6.77 (172.0)	7.76 (197.1)	9.29 (236.0)	11.46 (291.1)
B	2.67 (67.8)	3.05 (77.5)	3.72 (94.5)	4.61 (117.1)
C	2.38 (60.4)	2.62 (66.6)	3.00 (76.2)	3.62 (92.0)
D	0.94 (23.9)	1.06 (26.9)	1.25 (31.8)	1.62 (41.2)
E	0.47 (11.9)	0.53 (13.5)	0.62 (15.8)	0.81 (20.6)
F	1/4" Pipe	3/8" Pipe	1/2" Pipe	3/4" Pipe
G	2.25 (57.2)	2.38 (60.4)	2.62 (66.6)	3.25 (82.6)
H	1.12 (28.4)	1.19 (30.2)	1.31 (33.3)	1.62 (41.2)
J	2.63 (66.8)	3.13 (79.5)	3.72 (94.5)	4.56 (115.8)
K	1.31 (33.3)	1.56 (39.6)	1.86 (47.2)	2.28 (57.9)
L	0.34 (8.6)	0.34 (8.6)	0.41 (10.4)	0.41 (10.4)
M	1.12 (28.4)	1.12 (28.4)	1.25 (31.8)	1.56 (39.6)
N	0.25 (6.4)	0.25 (6.4)	0.31 (7.9)	0.31 (7.9)
R	6.78 (172.2)	6.78 (172.2)	8.10 (205.7)	10.73 (272.5)
Travel	0.62 (15.7)	0.69 (17.5)	0.88 (22.4)	1.12 (28.4)

Inches (mm)

M085 Stem Stop, Small Bracket

4-Way

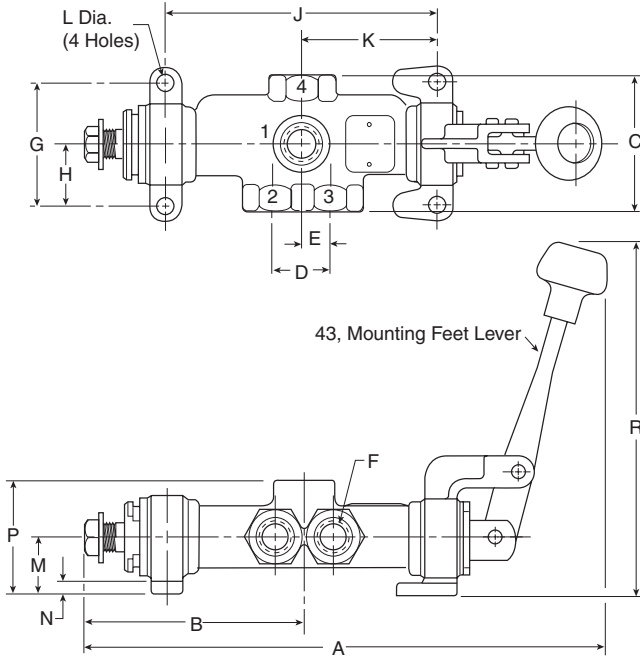

	1/4	3/8	1/2	3/4
A	8.28 (210.3)	9.60 (243.8)	11.08 (281.4)	14.17 (359.9)
B	3.42 (86.9)	3.97 (100.8)	4.78 (121.4)	5.97 (151.6)
C	2.38 (60.4)	2.62 (66.6)	3.12 (79.2)	3.62 (92.0)
D	0.94 (23.9)	1.06 (26.9)	1.25 (31.8)	1.62 (41.2)
E	0.47 (11.9)	0.53 (13.5)	0.62 (15.8)	0.81 (20.6)
F	1/4" Pipe	3/8" Pipe	1/2" Pipe	3/4" Pipe
G	2.25 (57.2)	2.38 (60.4)	2.62 (66.6)	3.25 (82.6)
H	1.12 (28.4)	1.19 (30.2)	1.31 (33.3)	1.62 (41.2)
J	4.14 (105.2)	4.98 (126.5)	5.85 (148.6)	7.39 (187.7)
K	2.07 (52.6)	2.49 (63.2)	2.92 (74.2)	3.69 (93.7)
L	0.34 (8.6)	0.34 (8.6)	0.41 (10.4)	0.41 (10.4)
M	1.12 (28.4)	1.12 (28.4)	1.25 (31.8)	1.56 (39.6)
N	0.25 (6.4)	0.25 (6.4)	0.31 (7.9)	0.31 (7.9)
P	2.12 (53.8)	2.18 (55.4)	2.63 (66.8)	3.06 (77.7)
R	6.78 (172.2)	6.78 (172.2)	8.10 (205.7)	10.73 (272.5)
Travel	0.62 (15.7)	0.69 (17.5)	0.88 (22.4)	1.12 (28.4)

Inches (mm)

Directair 2
& 4 Series

Viking Xtreme
Lever Series

42 Lever /
Pedal Series

MO Series

Safety



Manual / Mechanical
Valves

Brass Poppet /
Sliding Seal

Control Panel
Products

Sensing



For inventory, lead times, and kit lookup, visit www.pdnplu.com

E38

Parker Hannifin Corporation
Pneumatic Division
Richland, Michigan
www.parker.com/pneumatics

Lever Operated, Spring Return

M095 Direct Acting, Small Bracket (Push Lever) & M096 Reverse Acting, Small Bracket (Pull Lever)

3-Way

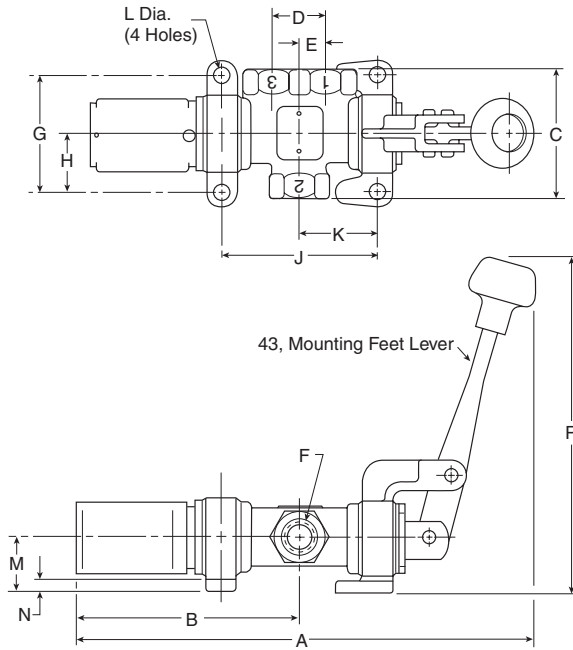

	1/4	3/8	1/2	3/4
A	7.99 (202.8)	8.94 (227.0)	10.88 (276.4)	13.76 (349.5)
B	3.92 (99.5)	4.24 (107.6)	5.31 (134.9)	6.92 (175.8)
C	2.38 (60.4)	2.62 (66.6)	3.00 (76.2)	3.62 (92.0)
D	0.94 (23.9)	1.06 (26.9)	1.25 (31.8)	1.62 (41.2)
E	0.47 (11.9)	0.53 (13.5)	0.62 (15.8)	0.81 (20.6)
F	1/4" Pipe	3/8" Pipe	1/2" Pipe	3/4" Pipe
G	2.25 (57.2)	2.38 (60.4)	2.62 (66.6)	3.25 (82.6)
H	1.12 (28.4)	1.19 (30.2)	1.31 (33.3)	1.62 (41.2)
J	2.63 (66.8)	3.13 (79.5)	3.72 (94.5)	4.56 (115.8)
K	1.31 (33.3)	1.56 (39.6)	1.86 (47.2)	2.28 (57.9)
L	0.34 (8.6)	0.34 (8.6)	0.41 (10.4)	0.41 (10.4)
M	1.12 (28.4)	1.12 (28.4)	1.25 (31.8)	1.56 (39.6)
N	0.25 (6.4)	0.25 (6.4)	0.31 (7.9)	0.31 (7.9)
R	6.78 (172.2)	6.78 (172.2)	8.10 (205.7)	10.73 (272.5)
Travel	0.62 (15.7)	0.69 (17.5)	0.88 (22.4)	1.12 (28.4)

Inches (mm)

M095 Direct Acting, Small Bracket (Push Lever) & M096 Reverse Acting, Small Bracket (Pull Lever)

3-Way

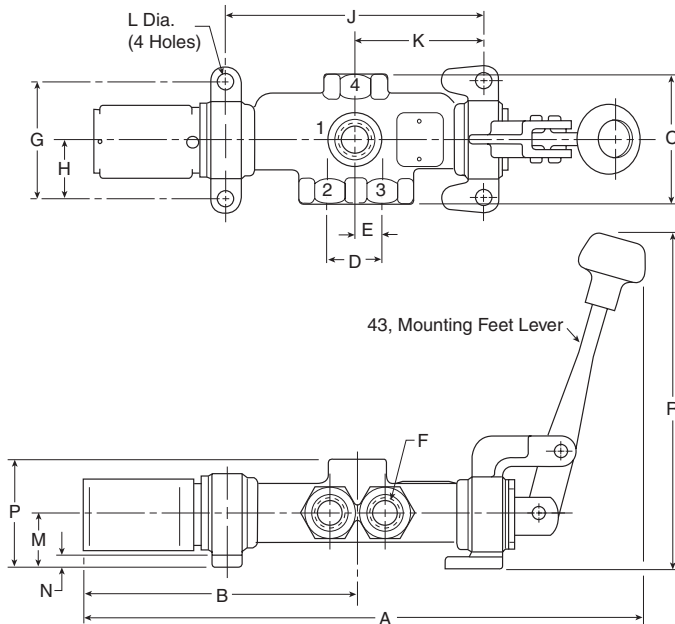

	1/4	3/8	1/2	3/4
A	9.53 (242.1)	10.78 (273.8)	12.67 (321.8)	16.47 (418.3)
B	4.67 (118.6)	5.15 (130.8)	5.68 (144.3)	8.27 (210.1)
C	2.38 (60.4)	2.62 (66.6)	3.12 (79.2)	3.62 (92.0)
D	0.94 (23.9)	1.06 (26.9)	1.25 (31.8)	1.62 (41.2)
E	0.47 (11.9)	0.53 (13.5)	0.62 (15.8)	0.81 (20.6)
F	1/4" Pipe	3/8" Pipe	1/2" Pipe	3/4" Pipe
G	2.25 (57.2)	2.38 (60.4)	2.62 (66.6)	3.25 (82.6)
H	1.12 (28.4)	1.19 (30.2)	1.31 (33.3)	1.62 (41.2)
J	4.14 (105.2)	4.98 (126.5)	5.85 (148.6)	7.39 (187.7)
K	2.07 (52.6)	2.49 (63.2)	2.92 (74.2)	3.69 (93.7)
L	0.34 (8.6)	0.34 (8.6)	0.41 (10.4)	0.41 (10.4)
M	1.12 (28.4)	1.12 (28.4)	1.25 (31.8)	1.56 (39.6)
N	0.25 (6.4)	0.25 (6.4)	0.31 (7.9)	0.31 (7.9)
P	2.12 (53.8)	2.18 (55.4)	2.63 (66.8)	3.06 (77.7)
R	6.78 (172.2)	6.78 (172.2)	8.10 (205.7)	10.73 (272.5)
Travel	0.62 (15.7)	0.69 (17.5)	0.88 (22.4)	1.12 (28.4)

Inches (mm)



For inventory, lead times, and kit lookup, visit www.pdnplu.com

Directair 2
& 4 Series

Viking Xtreme
Lever Series

42 Lever/
Pedal Series

MO Series

Safety



Manual / Mechanical
Valves

Brass Poppet /
Sliding Seal

Control Panel
Products

Sensing

Dimensional Data

Treadle Operated, Manual Return, Stem Stop

M085 Stem Stop, Small Bracket

3-Way

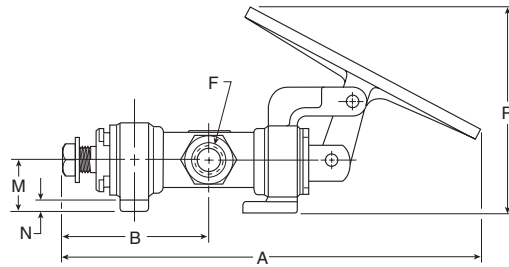
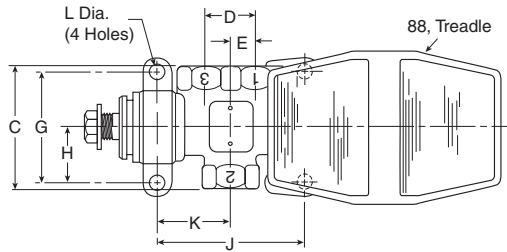

	1/4	3/8	1/2
A	8.01 (203.4)	8.73 (221.7)	10.32 (262.1)
B	2.67 (68.8)	3.06 (77.7)	4.06 (103.1)
C	2.38 (60.4)	2.62 (66.6)	3.00 (76.2)
D	0.94 (23.9)	1.06 (26.9)	1.25 (31.8)
E	0.47 (11.9)	0.53 (13.5)	0.62 (15.8)
F	1/4" Pipe	3/8" Pipe	1/2" Pipe
G	2.25 (57.2)	2.38 (60.4)	2.62 (66.6)
H	1.12 (28.4)	1.19 (30.2)	1.31 (33.3)
J	2.63 (66.8)	3.13 (79.5)	3.72 (94.5)
K	1.31 (33.3)	1.56 (39.6)	1.86 (47.2)
L	0.34 (8.6)	0.34 (8.6)	0.41 (10.4)
M	1.12 (28.4)	1.12 (28.4)	1.25 (31.8)
N	0.25 (6.4)	0.25 (6.4)	0.31 (7.9)
R	4.51 (114.6)	4.65 (118.1)	4.85 (123.2)
Travel	0.62 (15.8)	0.69 (17.5)	0.88 (22.4)

Inches (mm)

M085 Stem Stop, Small Bracket

4-Way

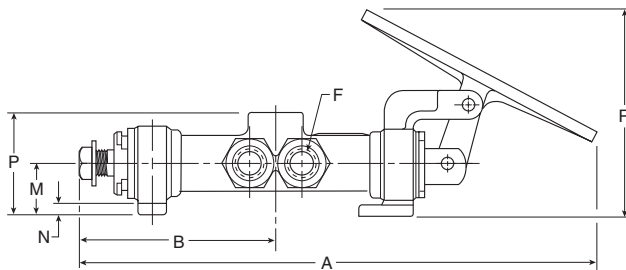
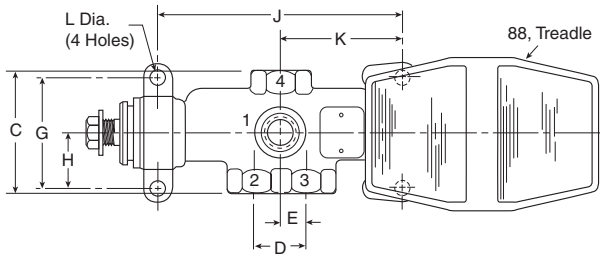

	1/4	3/8	1/2
A	9.52 (241.8)	10.57 (268.5)	12.11 (307.6)
B	3.42 (86.9)	3.97 (100.8)	4.78 (121.4)
C	2.38 (60.4)	2.62 (66.6)	3.12 (79.2)
D	0.94 (23.9)	1.06 (26.9)	1.25 (31.8)
E	0.47 (11.9)	0.53 (13.5)	0.62 (15.8)
F	1/4" Pipe	3/8" Pipe	1/2" Pipe
G	2.25 (57.2)	2.38 (60.4)	2.62 (66.6)
H	1.12 (28.4)	1.19 (30.2)	1.31 (33.3)
J	4.14 (105.2)	4.98 (126.5)	5.85 (148.6)
K	2.07 (52.6)	2.49 (63.2)	2.92 (74.2)
L	0.34 (8.6)	0.34 (8.6)	0.41 (10.4)
M	1.12 (28.4)	1.12 (28.4)	1.25 (31.8)
N	0.25 (6.4)	0.25 (6.4)	0.31 (7.9)
P	2.12 (53.8)	2.18 (55.4)	2.63 (66.8)
R	4.51 (114.6)	4.65 (118.1)	4.85 (123.2)
Travel	0.62 (15.8)	0.69 (17.5)	0.88 (22.4)

Inches (mm)

Directair 2
& 4 Series

Viking Xtreme
Lever Series

4/2 Lever /
Pedal Series

MO Series

Safety



M085 Stem Stop, Small Bracket

4-Way

Manual / Mechanical
Valves

Brass Poppet /
Sliding Seal

Control Panel
Products

Sensing



For inventory, lead times, and kit lookup, visit www.pdnplu.com

E40

Parker Hannifin Corporation
Pneumatic Division
Richland, Michigan
www.parker.com/pneumatics

Pedal Operated, Spring Return

M062 Direct Acting Spring Return, Less Bracket (Push Lever)

3-Way

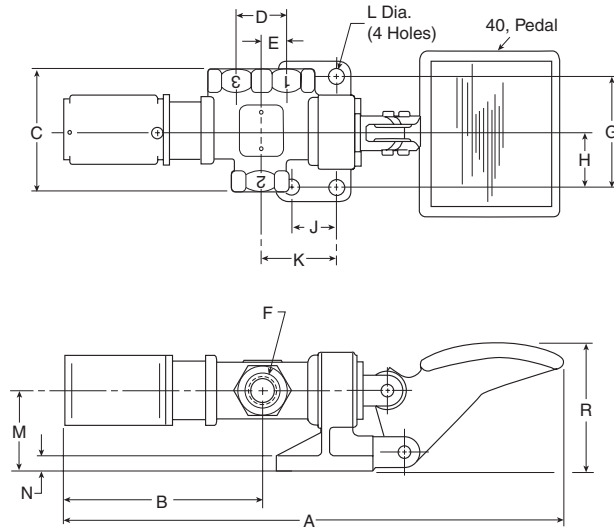

	1/4	3/8	1/2
A	9.99 (253.8)	10.50 (269.2)	12.66 (321.6)
B	3.92 (99.5)	4.23 (107.4)	5.31 (134.9)
C	2.38 (60.4)	2.62 (66.6)	3.00 (76.2)
D	0.94 (23.9)	1.06 (26.9)	1.25 (31.8)
E	0.47 (11.9)	0.53 (13.5)	0.62 (15.8)
F	1/4" Pipe	3/8" Pipe	1/2" Pipe
G	2.25 (57.2)	2.38 (60.4)	2.62 (66.6)
H	1.12 (28.4)	1.19 (30.2)	1.31 (33.3)
J	0.97 (24.6)	0.97 (24.6)	1.12 (28.4)
K	1.44 (36.6)	1.56 (39.6)	1.83 (46.5)
L	0.34 (8.6)	0.34 (8.6)	0.41 (10.4)
M	1.72 (43.7)	1.72 (43.7)	2.00 (50.8)
N	0.31 (7.9)	0.31 (7.9)	0.38 (9.6)
R	2.66 (67.6)	2.71 (68.8)	2.74 (69.6)
Travel	0.62 (15.8)	0.69 (17.5)	0.88 (22.4)

Inches (mm)

M062 Direct Acting Spring Return, Less Bracket (Push Lever)

4-Way

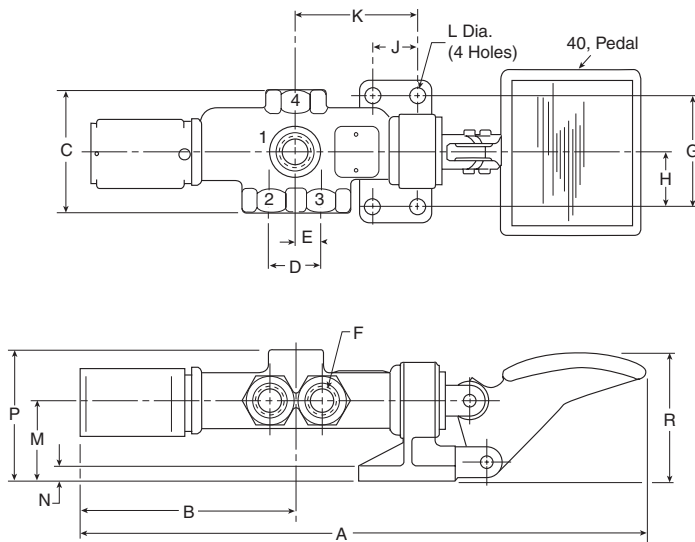

	1/4	3/8	1/2
A	11.50 (292.1)	12.44 (315.9)	14.45 (367.0)
B	4.67 (118.5)	5.15 (130.8)	5.68 (144.3)
C	2.38 (60.4)	2.62 (66.6)	3.00 (76.2)
D	0.94 (23.9)	1.06 (26.9)	1.25 (31.8)
E	0.47 (11.9)	0.53 (13.5)	0.62 (15.8)
F	1/4" Pipe	3/8" Pipe	1/2" Pipe
G	2.25 (57.2)	2.38 (60.4)	2.62 (66.6)
H	1.12 (28.4)	1.19 (30.2)	1.31 (33.3)
J	0.97 (24.6)	0.97 (24.6)	1.12 (28.4)
K	2.19 (55.6)	2.48 (63.0)	2.89 (73.4)
L	0.34 (8.6)	0.34 (8.6)	0.41 (10.4)
M	1.72 (43.7)	1.72 (43.7)	2.00 (50.8)
N	0.31 (7.9)	0.31 (7.9)	0.38 (9.6)
P	2.72 (69.1)	2.78 (70.6)	3.38 (85.8)
R	2.66 (67.6)	2.71 (68.8)	2.74 (69.6)
Travel	0.62 (15.8)	0.69 (17.5)	0.88 (22.4)

Inches (mm)



For inventory, lead times, and kit lookup, visit www.pdnplu.com

Directair 2
& 4 Series

Viking Xtreme
Lever Series

42 Lever/
Pedal Series

MO Series

Safety



Manual / Mechanical
Valves

Brass Poppet /
Sliding Seal

Control Panel
Products

Sensing

Dimensional Data

MO Series

Clevis Operated, Mechanical Return, Stem Stop

M085 Stem Stop, Small Bracket

3-Way

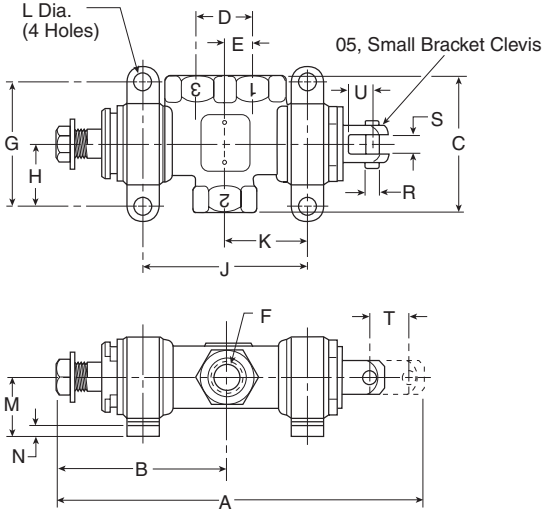

Inches (mm)

	1/4	3/8	1/2	3/4
A	5.31 (134.9)	6.01 (152.6)	7.36 (186.9)	8.92 (226.6)
B	2.68 (68.1)	3.06 (77.7)	4.85 (123.2)	4.62 (117.3)
C	2.38 (60.4)	2.62 (66.6)	3.00 (76.2)	3.62 (92.0)
D	0.94 (23.9)	1.06 (26.9)	1.25 (31.8)	1.62 (41.2)
E	0.47 (11.9)	0.53 (13.5)	0.62 (15.8)	0.81 (20.6)
F	1/4" Pipe	3/8" Pipe	1/2" Pipe	3/4" Pipe
G	2.25 (57.2)	2.38 (60.4)	2.62 (66.6)	3.25 (82.6)
H	1.12 (28.4)	1.19 (30.2)	1.31 (33.3)	1.62 (41.2)
J	2.64 (67.1)	3.14 (79.8)	3.73 (94.7)	4.67 (118.6)
K	1.32 (33.5)	1.57 (39.9)	1.87 (47.5)	2.33 (59.2)
L	0.34 (8.6)	0.34 (8.6)	0.41 (10.4)	0.41 (10.4)
M	1.12 (28.4)	1.12 (28.4)	1.25 (31.8)	1.56 (39.6)
N	0.25 (6.4)	0.25 (6.4)	0.31 (7.9)	0.31 (7.9)
R	0.25 (6.4)	0.25 (6.4)	0.31 (7.9)	0.31 (7.9)
S	0.38 (9.6)	0.38 (9.6)	0.44 (11.2)	0.44 (11.2)
U	0.47 (11.9)	0.47 (11.9)	0.56 (14.2)	0.62 (15.8)
Travel	0.62 (15.8)	0.69 (17.5)	0.88 (22.4)	1.12 (28.4)

M085 Stem Stop, Small Bracket

4-Way

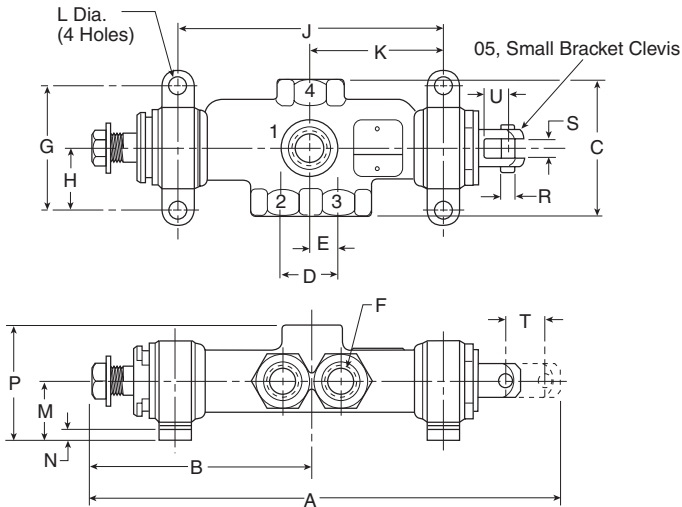

Inches (mm)

	1/4	3/8	1/2	3/4
A	6.81 (173.0)	7.85 (199.4)	9.48 (240.8)	11.64 (295.7)
B	3.42 (86.9)	3.97 (100.8)	5.91 (150.1)	5.97 (151.6)
C	2.38 (60.4)	2.62 (66.6)	3.12 (79.2)	3.62 (92.0)
D	0.94 (23.9)	1.06 (26.9)	1.25 (31.8)	1.62 (41.2)
E	0.47 (11.9)	0.53 (13.5)	0.62 (15.8)	0.81 (20.6)
F	1/4" Pipe	3/8" Pipe	1/2" Pipe	3/4" Pipe
G	2.25 (57.2)	2.38 (60.4)	2.62 (66.6)	3.25 (82.6)
H	1.12 (28.4)	1.19 (30.2)	1.31 (33.3)	1.62 (41.2)
J	4.14 (105.2)	4.98 (126.5)	5.85 (148.6)	7.39 (187.7)
K	2.07 (52.6)	2.49 (63.2)	2.92 (74.2)	3.69 (93.7)
L	0.34 (8.6)	0.34 (8.6)	0.41 (10.4)	0.41 (10.4)
M	1.12 (28.4)	1.12 (28.4)	1.25 (31.8)	1.56 (39.6)
N	0.25 (6.4)	0.25 (6.4)	0.31 (7.9)	0.31 (7.9)
P	2.12 (53.8)	2.18 (55.4)	2.63 (66.8)	3.06 (77.7)
R	0.25 (6.4)	0.25 (6.4)	0.31 (7.9)	0.31 (7.9)
S	0.38 (9.6)	0.38 (9.6)	0.44 (11.2)	0.44 (11.2)
U	0.47 (11.9)	0.47 (11.9)	0.56 (14.2)	0.62 (15.8)
Travel	0.62 (15.8)	0.69 (17.5)	0.88 (22.4)	1.12 (28.4)



For inventory, lead times, and kit lookup, visit www.pdnplu.com

Directair 2 & 4 Series
 Viking Xtreme Lever Series
 42 Lever / Pedal Series
 MO Series
 Safety
 Manual / Mechanical Valves
 Brass Poppet / Sliding Seal
 Control Panel Products
 Sensing

Clevis Operated, Spring Return, Small Bracket

M095 Direct Acting (Push Lever) & M096 Reverse Acting (Pull Lever)

3-Way

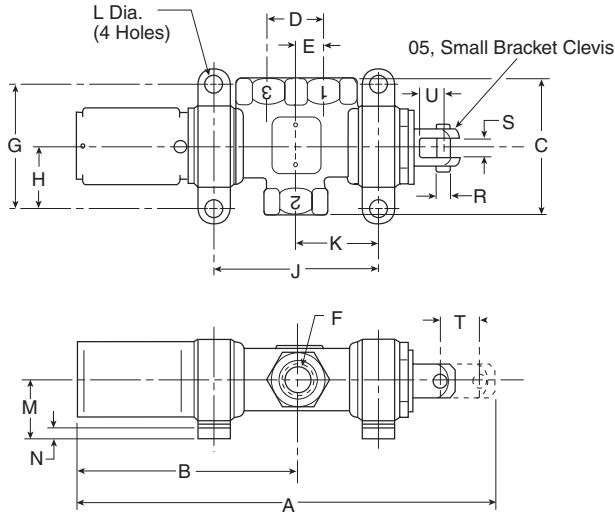

Inches (mm)

	1/4	3/8	1/2	3/4
A	6.56 (166.5)	7.19 (182.6)	8.95 (227.3)	11.22 (285.0)
B	3.92 (99.5)	4.24 (107.6)	5.31 (134.9)	6.92 (175.8)
C	2.38 (60.4)	2.62 (66.6)	3.00 (76.2)	3.62 (92.0)
D	0.94 (23.9)	1.06 (26.9)	1.25 (31.8)	1.62 (41.2)
E	0.47 (11.9)	0.53 (13.5)	0.62 (15.8)	0.81 (20.6)
F	1/4" Pipe	3/8" Pipe	1/2" Pipe	3/4" Pipe
G	2.25 (57.2)	2.38 (60.4)	2.62 (66.6)	3.25 (82.6)
H	1.12 (28.4)	1.19 (30.2)	1.31 (33.3)	1.62 (41.2)
J	2.63 (66.8)	3.13 (79.5)	3.72 (94.5)	4.56 (115.8)
K	1.31 (33.3)	1.56 (39.6)	1.86 (47.2)	2.28 (57.9)
L	0.34 (8.6)	0.34 (8.6)	0.41 (10.4)	0.41 (10.4)
M	1.12 (28.4)	1.12 (28.4)	1.25 (31.8)	1.56 (39.6)
N	0.25 (6.4)	0.25 (6.4)	0.31 (7.9)	0.31 (7.9)
R	0.25 (6.4)	0.25 (6.4)	0.31 (7.9)	0.31 (7.9)
S	0.38 (9.6)	0.38 (9.6)	0.44 (11.2)	0.44 (11.2)
U	0.47 (11.9)	0.47 (11.9)	0.56 (14.2)	0.62 (15.8)
Travel	0.62 (15.8)	0.69 (17.5)	0.88 (22.4)	1.12 (28.4)

M095 Direct Acting (Push Lever) & M096 Reverse Acting (Pull Lever)

4-Way

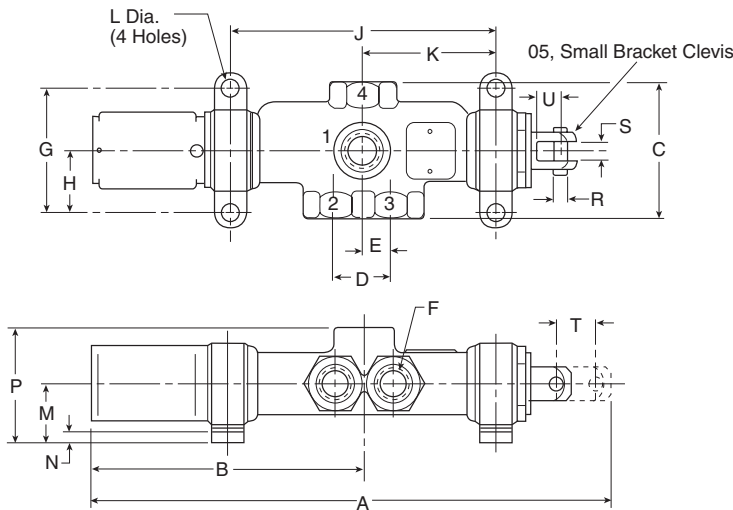

Inches (mm)

	1/4	3/8	1/2	3/4
A	8.06 (204.6)	9.03 (229.3)	11.07 (281.2)	13.94 (354.1)
B	4.67 (118.6)	5.15 (130.8)	5.68 (144.3)	8.27 (210.1)
C	2.38 (60.4)	2.62 (66.6)	3.00 (76.2)	3.62 (92.0)
D	0.94 (23.9)	1.06 (26.9)	1.25 (31.8)	1.62 (41.2)
E	0.47 (11.9)	0.53 (13.5)	0.62 (15.8)	0.81 (20.6)
F	1/4" Pipe	3/8" Pipe	1/2" Pipe	3/4" Pipe
G	2.25 (57.2)	2.38 (60.4)	2.62 (66.6)	3.25 (82.6)
H	1.12 (28.4)	1.19 (30.2)	1.31 (33.3)	1.62 (41.2)
J	4.14 (105.2)	4.98 (126.5)	5.85 (148.6)	7.39 (187.7)
K	2.07 (52.6)	2.49 (63.2)	2.9 (74.2)	3.69 (93.7)
L	0.34 (8.6)	0.34 (8.6)	0.41 (10.4)	0.41 (10.4)
M	1.12 (28.4)	1.12 (28.4)	1.25 (31.8)	1.56 (39.6)
N	0.25 (6.4)	0.25 (6.4)	0.31 (7.9)	0.31 (7.9)
P	2.12 (53.8)	2.18 (55.4)	2.63 (66.8)	3.06 (77.7)
R	0.25 (6.4)	0.25 (6.4)	0.31 (7.9)	0.31 (7.9)
S	0.38 (9.6)	0.38 (9.6)	0.44 (11.2)	0.44 (11.2)
U	0.47 (11.9)	0.47 (11.9)	0.56 (14.2)	0.62 (15.8)
Travel	0.62 (15.8)	0.69 (17.5)	0.88 (22.4)	1.12 (28.4)



For inventory, lead times, and kit lookup, visit www.pdnplu.com

Directair 2
& 4 Series

Viking Xtreme
Lever Series

42 Lever/
Pedal Series

MO Series

Safety



Manual / Mechanical
Valves

Brass Poppet /
Sliding Seal

Control Panel
Products

Sensing

Single Diaphragm Operated, Spring Return Stem Stop

M084 Stem Stop, Large Bracket

3-Way

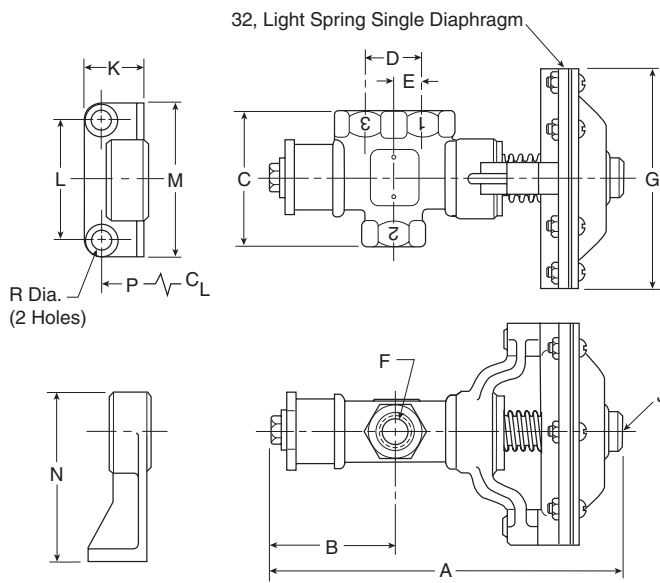

	1/4	3/8	1/2	3/4
A	6.14 (156.0)	6.85 (174.0)	8.03 (204.0)	9.89 (251.2)
B	2.03 (51.6)	2.36 (59.9)	2.83 (71.9)	3.48 (88.4)
C	2.38 (60.4)	2.62 (66.6)	3.00 (76.2)	3.62 (92.0)
D	0.94 (23.9)	1.06 (26.9)	1.25 (31.8)	1.62 (41.2)
E	0.47 (11.9)	0.53 (13.5)	0.62 (15.8)	0.81 (20.6)
F	1/4" Pipe	3/8" Pipe	1/2" Pipe	3/4" Pipe
G	4.34 (110.2)	4.34 (110.2)	4.34 (110.2)	5.27 (133.9)
J	1/8" Pipe	1/8" Pipe	1/8" Pipe	1/8" Pipe
K	1.12 (28.4)	1.12 (28.4)	1.75 (44.4)	2.00 (50.8)
L	2.00 (50.8)	2.38 (60.4)	2.00 (50.8)	3.25 (82.6)
M	2.75 (69.8)	3.00 (76.2)	3.00 (76.2)	4.19 (106.4)
N	3.22 (81.8)	3.28 (83.3)	3.40 (86.4)	4.00 (101.6)
P	1.81 (46.0)	2.03 (51.6)	2.74 (69.6)	3.18 (80.8)
R	0.34 (8.6)	0.34 (8.6)	0.41 (10.4)	0.41 (10.4)
Travel	0.62 (15.8)	0.69 (17.5)	0.88 (22.4)	1.12 (28.4)

Inches (mm)

M084 Stem Stop, Large Bracket

4-Way

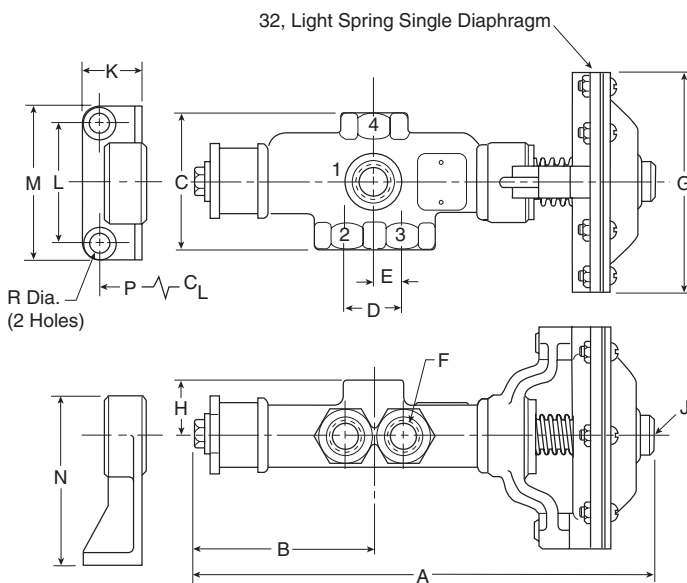

	1/4	3/8	1/2	3/4
A	7.65 (194.3)	8.69 (220.7)	9.82 (249.4)	12.60 (320.0)
B	2.79 (70.9)	3.28 (83.3)	3.89 (98.8)	4.84 (122.9)
C	2.38 (60.4)	2.62 (66.6)	3.12 (79.2)	3.62 (92.0)
D	0.94 (23.9)	1.06 (26.9)	1.25 (31.8)	1.62 (41.2)
E	0.47 (11.9)	0.53 (13.5)	0.62 (15.8)	0.81 (20.6)
F	1/4" Pipe	3/8" Pipe	1/2" Pipe	3/4" Pipe
G	4.34 (110.2)	4.34 (110.2)	4.34 (110.2)	5.27 (133.9)
H	1.00 (25.4)	1.06 (26.9)	1.38 (30.0)	1.50 (38.1)
J	1/8" Pipe	1/8" Pipe	1/8" Pipe	1/8" Pipe
K	1.12 (28.4)	1.12 (28.4)	1.75 (44.4)	2.00 (50.8)
L	2.00 (50.8)	2.38 (60.4)	2.00 (50.8)	3.25 (82.6)
M	2.75 (69.8)	3.00 (76.2)	3.00 (76.2)	4.19 (106.4)
N	3.22 (81.8)	3.28 (83.3)	3.40 (86.4)	4.00 (101.6)
P	2.57 (65.3)	2.95 (74.9)	3.80 (96.5)	4.54 (115.3)
R	0.34 (8.6)	0.34 (8.6)	0.41 (10.4)	0.41 (10.4)
Travel	0.62 (15.8)	0.69 (17.5)	0.88 (22.4)	1.12 (28.4)

Inches (mm)

Directair 2 & 4 Series
 Viking Xtreme Lever Series
 4/2 Lever / Pedal Series
 MO Series
 Safety
 Manual / Mechanical Valves
 Brass Poppet / Sliding Seal
 Control Panel Products
 Sensing

Double Diaphragm Operated

M033 Double Diaphragm

3-Way

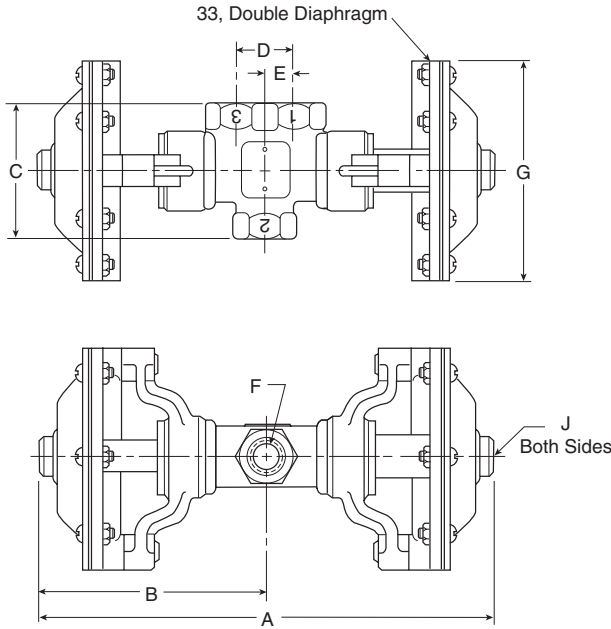

	1/4	3/8	1/2	3/4
A	8.22 (208.8)	8.98 (228.1)	10.40 (264.2)	12.82 (325.6)
B	4.11 (104.4)	4.49 (114.0)	5.20 (132.1)	6.41 (162.8)
C	2.38 (60.4)	2.62 (66.6)	3.00 (76.2)	3.62 (92.0)
D	.94 (23.9)	1.06 (26.9)	1.25 (31.8)	1.62 (41.2)
E	.47 (11.9)	.53 (13.5)	.62 (15.8)	.81 (20.6)
F	1/4" Pipe	3/8" Pipe	1/2" Pipe	3/4" Pipe
G	4.34 (110.2)	4.34 (110.2)	4.34 (110.2)	5.27 (133.9)
J	1/8" Pipe	1/8" Pipe	1/8" Pipe	1/8" Pipe

Inches (mm)

M033 Double Diaphragm

4-Way

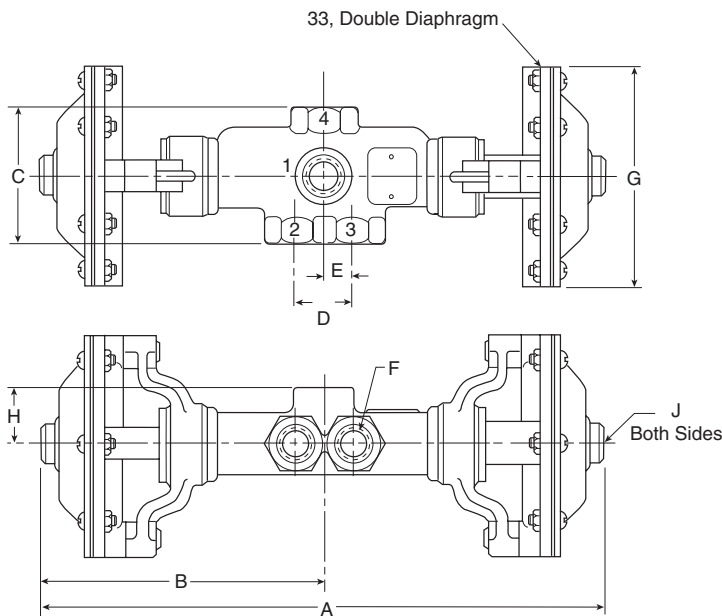

	1/4	3/8	1/2	3/4
A	9.72 (246.9)	10.82 (274.8)	11.86 (301.2)	15.52 (394.2)
B	4.86 (123.4)	5.41 (137.4)	5.93 (150.6)	7.76 (197.1)
C	2.38 (60.4)	2.62 (66.6)	3.12 (79.2)	3.62 (92.0)
D	.94 (23.9)	1.06 (26.9)	1.25 (31.8)	1.62 (41.2)
E	.47 (11.9)	.53 (13.5)	.62 (15.8)	.81 (20.6)
F	1/4" Pipe	3/8" Pipe	1/2" Pipe	3/4" Pipe
G	4.34 (110.2)	4.34 (110.2)	4.34 (110.2)	5.27 (133.9)
H	1.00 (25.4)	1.06 (26.9)	1.38 (30.0)	1.50 (38.1)
J	1/8" Pipe	1/8" Pipe	1/8" Pipe	1/8" Pipe

Inches (mm)

Dimensional Data

MO Series

Single Cylinder Operated, Spring Return, Stem Stop

M085 Stem Stop, Small Bracket

3-Way

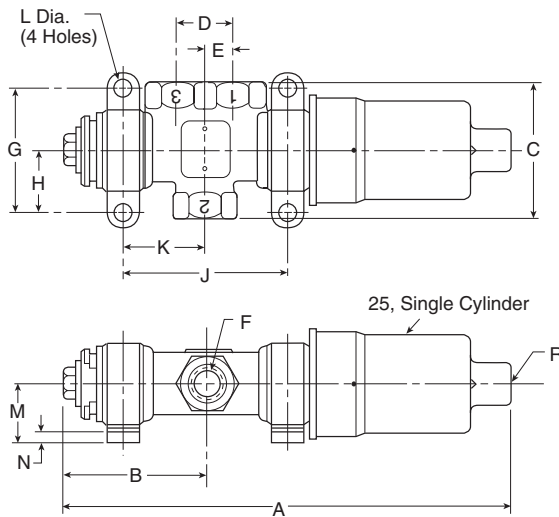

	1/4	3/8	1/2	3/4
A	7.50 (190.5)	8.14 (206.8)	9.03 (229.4)	11.18 (284.0)
B	2.03 (51.6)	2.36 (59.9)	2.83 (71.9)	3.48 (88.4)
C	2.38 (60.4)	2.62 (66.6)	3.00 (76.2)	3.62 (92.0)
D	.94 (23.9)	1.06 (26.9)	1.25 (31.8)	1.62 (41.2)
E	.47 (11.9)	.53 (13.5)	.62 (15.8)	.81 (20.6)
F	1/4" Pipe	3/8" Pipe	1/2" Pipe	3/4" Pipe
G	2.25 (57.2)	2.38 (60.4)	2.62 (66.6)	3.25 (82.6)
H	1.12 (28.4)	1.19 (30.2)	1.31 (33.3)	1.62 (41.2)
J	2.64 (67.1)	3.14 (79.8)	3.73 (94.7)	4.67 (118.6)
K	1.32 (33.5)	1.57 (39.9)	1.87 (47.5)	2.33 (59.2)
L	.34 (8.6)	.34 (8.6)	.41 (10.4)	.41 (10.4)
M	1.12 (28.4)	1.12 (28.4)	1.25 (31.8)	1.56 (39.6)
N	.25 (6.4)	.25 (6.4)	.31 (7.9)	.31 (7.9)
R	1/4" Pipe	1/4" Pipe	1/4" Pipe	1/4" Pipe
Travel	.62 (15.7)	.69 (17.5)	.88 (22.4)	1.12 (28.4)

Inches (mm)

M085 Stem Stop, Small Bracket

4-Way

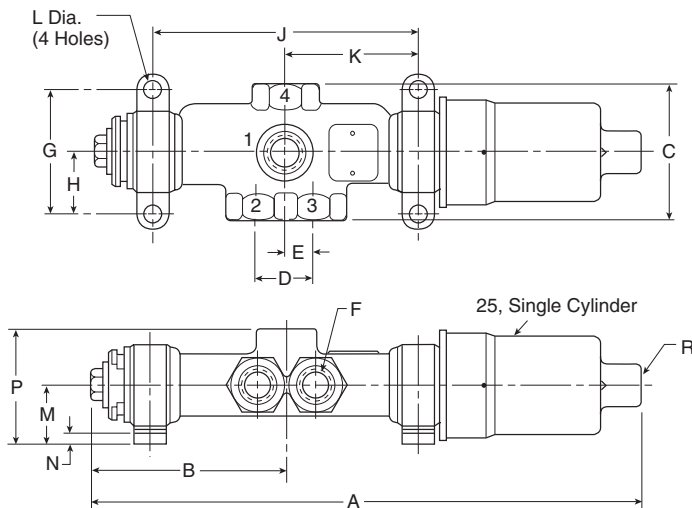

	1/4	3/8	1/2	3/4
A	9.00 (228.6)	9.98 (253.5)	11.15 (283.2)	13.90 (353.1)
B	2.79 (70.9)	3.28 (83.3)	3.89 (98.8)	4.84 (122.9)
C	2.38 (60.4)	2.62 (66.6)	3.12 (79.2)	3.62 (92.0)
D	.94 (23.9)	1.06 (26.9)	1.25 (31.8)	1.62 (41.2)
E	.47 (11.9)	.53 (13.5)	.62 (15.8)	.81 (20.6)
F	1/4" Pipe	3/8" Pipe	1/2" Pipe	3/4" Pipe
G	2.25 (57.2)	2.38 (60.4)	2.62 (66.6)	3.25 (82.6)
H	1.12 (28.4)	1.19 (30.2)	1.31 (33.3)	1.62 (41.2)
J	4.14 (105.2)	4.98 (126.5)	5.85 (148.6)	7.39 (187.7)
K	2.07 (52.6)	2.49 (63.2)	2.92 (74.2)	3.69 (93.7)
L	.34 (8.6)	.34 (8.6)	.41 (10.4)	.41 (10.4)
M	1.12 (28.4)	1.12 (28.4)	1.25 (31.8)	1.56 (39.6)
N	.25 (6.4)	.25 (6.4)	.31 (7.9)	.31 (7.9)
P	2.12 (53.8)	2.18 (55.4)	2.63 (66.8)	3.06 (77.7)
R	1/4" Pipe	1/4" Pipe	1/4" Pipe	1/4" Pipe
Travel	.62 (15.8)	.69 (17.5)	.88 (22.4)	1.12 (28.4)

Inches (mm)



For inventory, lead times, and kit lookup, visit www.pdnplu.com

Directair 2 & 4 Series
Viking Xtreme Lever Series
4/2 Lever / Pedal Series
MO Series
Safety
Manual / Mechanical Valves
Brass Poppet / Sliding Seal
Control Panel Products
Sensing

Double Cylinder Operated

M019 Double Cylinder

3-Way

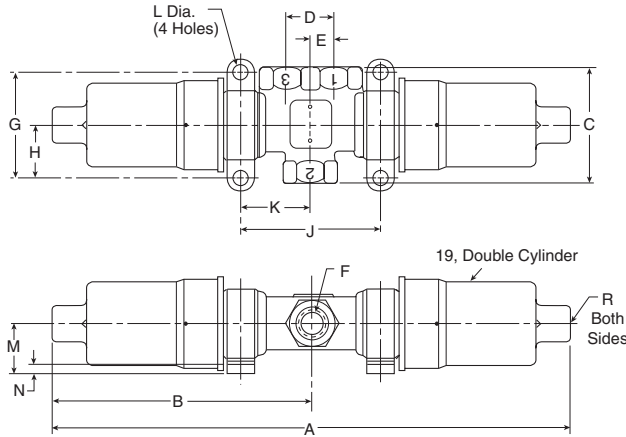

	1/4	3/8	1/2	3/4
A	10.94 (277.9)	11.56 (293.6)	12.40 (315.0)	15.40 (391.2)
B	5.47 (138.9)	5.78 (146.8)	6.20 (157.5)	7.70 (195.6)
C	2.38 (60.4)	2.62 (66.6)	3.00 (76.2)	3.62 (92.0)
D	.94 (23.9)	1.06 (26.9)	1.25 (31.8)	1.62 (41.2)
E	.47 (11.9)	.53 (13.5)	.62 (15.8)	.81 (20.6)
F	1/4" Pipe	3/8" Pipe	1/2" Pipe	3/4" Pipe
G	2.25 (57.2)	2.38 (60.4)	2.62 (66.6)	3.25 (82.6)
H	1.12 (28.4)	1.19 (30.2)	1.31 (33.3)	1.62 (41.2)
J	2.64 (67.1)	3.14 (79.8)	3.73 (94.7)	4.67 (118.6)
K	1.32 (33.5)	1.57 (39.9)	1.87 (47.5)	2.33 (59.2)
L	.34 (8.6)	.34 (8.6)	.41 (10.4)	.41 (10.4)
M	1.12 (28.4)	1.12 (28.4)	1.25 (31.8)	1.56 (39.6)
N	.25 (6.4)	.25 (6.4)	.31 (7.9)	.31 (7.9)
R	1/4" Pipe	1/4" Pipe	1/4" Pipe	1/4" Pipe

Inches (mm)

M019 Double Cylinder

4-Way

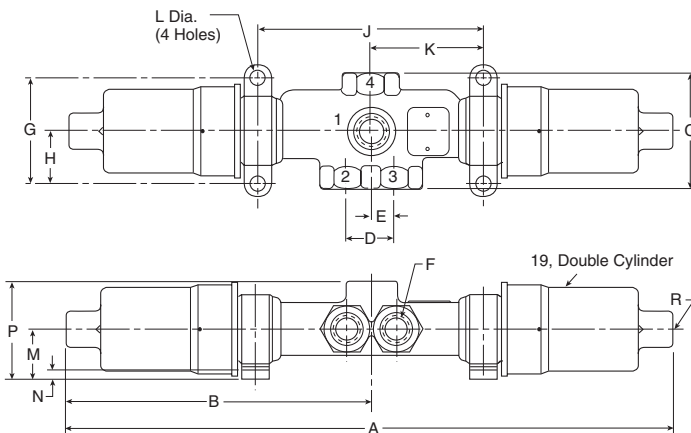

	1/4	3/8	1/2	3/4
A	12.42 (315.5)	13.40 (340.4)	14.52 (368.8)	18.12 (460.2)
B	6.21 (157.7)	6.70 (170.2)	7.26 (184.4)	9.06 (230.1)
C	2.38 (60.4)	2.62 (66.6)	3.12 (79.2)	3.62 (92.0)
D	.94 (23.9)	1.06 (26.9)	1.25 (31.8)	1.62 (41.2)
E	.47 (11.9)	.53 (13.5)	.62 (15.8)	.81 (20.6)
F	1/4" Pipe	3/8" Pipe	1/2" Pipe	3/4" Pipe
G	2.25 (57.2)	2.38 (60.4)	2.62 (66.6)	3.25 (82.6)
H	1.12 (28.4)	1.19 (30.2)	1.31 (33.3)	1.62 (41.2)
J	4.14 (105.2)	4.98 (126.5)	5.85 (148.6)	7.39 (187.7)
K	2.07 (52.6)	2.49 (63.2)	2.92 (74.2)	3.69 (93.7)
L	.34 (8.6)	.34 (8.6)	.41 (10.4)	.41 (10.4)
M	1.12 (28.4)	1.12 (28.4)	1.25 (31.8)	1.56 (39.6)
N	.25 (6.4)	.25 (6.4)	.31 (7.9)	.31 (7.9)
P	2.12 (53.8)	2.18 (55.4)	2.63 (66.8)	3.06 (77.7)
R	1/4" Pipe	1/4" Pipe	1/4" Pipe	1/4" Pipe

Inches (mm)



For inventory, lead times, and kit lookup, visit www.pdnplu.com

Directair 2
& 4 Series

Viking Xtreme
Lever Series

42 Lever/
Pedal Series

MO Series

Safety



Manual / Mechanical
Valves

Brass Poppet /
Sliding Seal

Control Panel
Products

Sensing

Dimensional Data

Cam Operated, Spring Return

M095 Direct Acting, Small Bracket (Push Lever)

3-Way

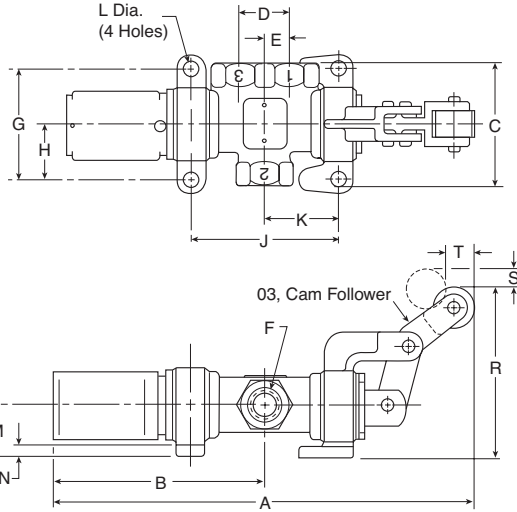

Inches (mm)

	1/4	3/8	1/2	3/4
A	7.98 (202.6)	8.72 (221.5)	10.77 (273.6)	13.54 (343.9)
B	3.92 (99.6)	4.24 (107.7)	5.31 (134.9)	6.92 (175.8)
C	2.38 (60.4)	2.62 (66.6)	3.00 (76.2)	3.62 (92.0)
D	.94 (23.9)	1.06 (26.9)	1.25 (31.8)	1.62 (41.2)
E	.47 (11.9)	.53 (13.5)	.62 (15.8)	.81 (20.6)
F	1/4" Pipe	3/8" Pipe	1/2" Pipe	3/4" Pipe
G	2.25 (57.2)	2.38 (60.4)	2.62 (66.6)	3.25 (82.6)
H	1.12 (28.4)	1.19 (30.2)	1.31 (33.3)	1.62 (41.2)
J	2.63 (66.8)	3.13 (79.5)	3.72 (94.5)	4.56 (115.8)
K	1.31 (33.3)	1.56 (39.6)	1.86 (47.2)	2.28 (57.9)
L	.34 (8.6)	.34 (8.6)	.41 (10.4)	.41 (10.4)
M	1.12 (38.4)	1.12 (28.4)	1.25 (31.8)	1.56 (39.6)
N	.25 (6.4)	.25 (6.4)	.31 (7.9)	.31 (7.9)
R	3.88 (98.6)	3.88 (98.6)	4.23 (107.4)	4.88 (124.0)
S	.43 (10.9)	.47 (11.9)	.70 (17.8)	.67 (17.0)
Travel	.53 (13.5)	.59 (15.0)	.75 (19.0)	.81 (20.6)

M095 Direct Acting, Small Bracket (Push Lever)

4-Way

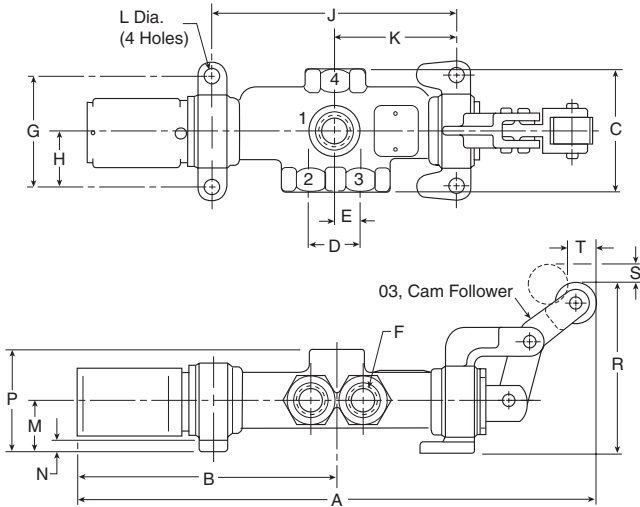

Inches (mm)

	1/4	3/8	1/2	3/4
A	9.48 (204.7)	10.56 (268.2)	12.89 (327.4)	16.26 (413.0)
B	4.67 (118.6)	5.15 (130.8)	5.68 (144.3)	8.27 (210.1)
C	2.38 (60.4)	2.62 (66.6)	3.12 (79.2)	3.62 (92.0)
D	.94 (23.9)	1.06 (26.9)	1.25 (31.8)	1.62 (41.2)
E	.47 (11.9)	.53 (13.5)	.62 (15.8)	.81 (20.6)
F	1/4" Pipe	3/8" Pipe	1/2" Pipe	3/4" Pipe
G	2.25 (57.2)	2.38 (60.4)	2.62 (66.6)	3.25 (82.6)
H	1.12 (28.4)	1.19 (30.2)	1.31 (33.3)	1.62 (41.2)
J	4.14 (105.2)	4.98 (126.5)	5.85 (148.6)	7.39 (187.7)
K	2.07 (52.6)	2.49 (63.2)	2.92 (74.2)	3.69 (93.7)
L	.34 (8.6)	.34 (8.6)	.41 (10.4)	.41 (10.4)
M	1.12 (28.4)	1.12 (28.4)	1.25 (31.8)	1.56 (39.6)
N	.25 (6.4)	.25 (6.4)	.31 (7.9)	.31 (7.9)
P	2.12 (53.8)	2.18 (55.4)	2.63 (66.8)	3.06 (77.7)
R	3.88 (98.6)	3.88 (98.6)	4.23 (107.4)	4.88 (124.0)
S	.43 (10.9)	.47 (11.9)	.70 (17.8)	.67 (17.0)
Travel	.53 (13.5)	.59 (15.0)	.75 (19.0)	.81 (20.6)



For inventory, lead times, and kit lookup, visit www.pdnplu.com

Lever & Treadle Operated, 2-Position Ball Detent

M054 Ball Detent, Small Bracket

3-Way

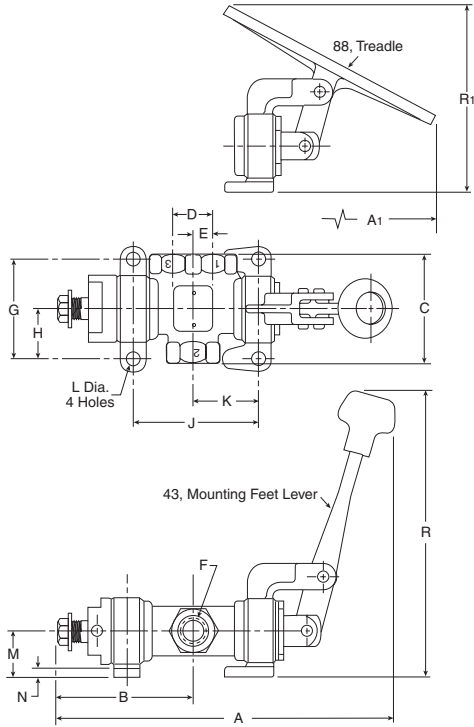

Inches (mm)

	1/4	3/8	1/2	3/4
A	7.35 (186.7)	8.36 (212.3)	9.95 (252.7)	12.25 (311.2)
A1	8.59 (218.2)	9.33 (237.0)	10.65 (270.5)	12.90 (327.7)
B	3.25 (82.6)	3.66 (93.0)	4.39 (111.5)	5.41 (137.4)
C	2.38 (60.4)	2.62 (66.6)	3.00 (76.2)	3.62 (92.0)
D	.94 (23.9)	1.06 (26.9)	1.25 (31.8)	1.62 (41.2)
E	.47 (11.9)	.53 (13.5)	.62 (15.8)	.81 (20.6)
F	1/4" Pipe	3/8" Pipe	1/2" Pipe	3/4" Pipe
G	2.25 (57.2)	2.38 (60.4)	2.62 (66.6)	3.25 (82.6)
H	1.12 (28.4)	1.19 (30.2)	1.31 (33.3)	1.62 (41.2)
J	2.63 (66.8)	3.13 (79.5)	3.72 (94.5)	4.56 (115.8)
K	1.31 (33.3)	1.56 (39.6)	1.86 (47.2)	2.28 (57.9)
L	.34 (8.6)	.34 (8.6)	.41 (10.4)	.41 (10.4)
M	1.12 (28.4)	1.12 (28.4)	1.25 (31.8)	1.56 (39.6)
N	.25 (6.4)	.25 (6.4)	.31 (7.9)	.31 (7.9)
R1	6.78 (172.2)	6.78 (172.2)	8.10 (205.7)	10.73 (272.5)
R2	4.51 (114.6)	4.65 (18.1)	4.85 (123.2)	6.03 (153.2)

M054 Ball Detent, Small Bracket

4-Way

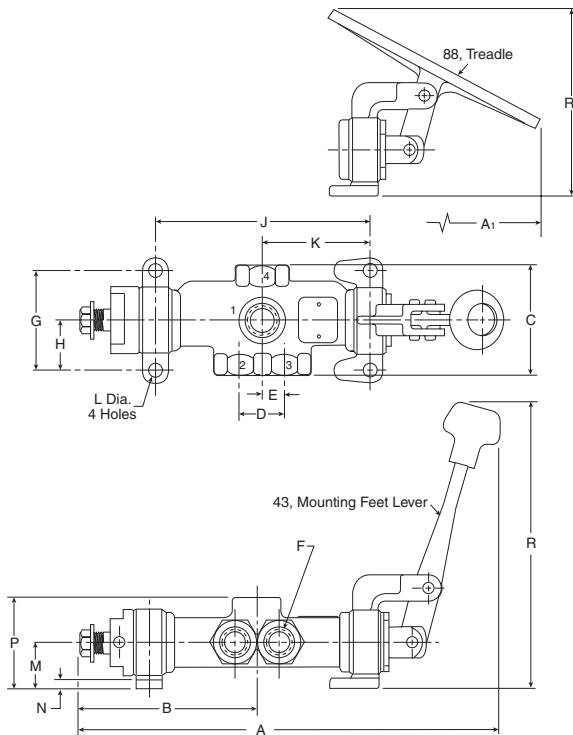

Inches (mm)

	1/4	3/8	1/2	3/4
A	8.86 (225.0)	10.20 (259.1)	11.74 (298.2)	14.96 (380.0)
A1	10.01 (254.2)	11.17 (283.7)	12.77 (324.4)	15.62 (396.8)
B	4.00 (101.6)	4.57 (116.1)	5.44 (138.2)	6.76 (171.7)
C	2.38 (60.4)	2.62 (66.6)	3.00 (76.2)	3.62 (92.0)
D	.94 (23.9)	1.06 (26.9)	1.25 (31.8)	1.62 (41.2)
E	.47 (11.9)	.53 (13.5)	.62 (15.8)	.81 (20.6)
F	1/4" Pipe	3/8" Pipe	1/2" Pipe	3/4" Pipe
G	2.25 (57.2)	2.38 (60.4)	2.62 (66.6)	3.25 (82.6)
H	1.12 (28.4)	1.19 (30.2)	1.31 (33.3)	1.62 (41.2)
J	4.14 (105.2)	4.98 (126.5)	5.85 (148.6)	7.39 (187.7)
K	2.07 (52.6)	2.49 (63.2)	2.92 (74.2)	3.69 (93.7)
L	.34 (8.6)	.34 (8.6)	.41 (10.4)	.41 (10.4)
M	1.12 (28.4)	1.12 (28.4)	1.25 (31.8)	1.56 (39.6)
N	.25 (6.4)	.25 (6.4)	.31 (7.9)	.31 (7.9)
P	2.12 (53.8)	2.18 (55.4)	2.63 (66.8)	3.06 (77.7)
R1	6.78 (172.2)	6.78 (172.2)	8.10 (205.7)	10.73 (272.5)
R2	4.51 (114.6)	4.65 (18.1)	4.85 (123.2)	6.03 (153.2)



For inventory, lead times, and kit lookup, visit www.pdnplu.com

Directair 2
& 4 Series

Viking Xtreme
Lever Series

42 Lever/
Pedal Series

MO Series

Safety



Manual / Mechanical
Valves

Brass Poppet /
Sliding Seal

Control Panel
Products

Sensing

Features

Parker is protecting your most valuable assets...



Standard 190.147

- This applies to the servicing and maintenance of a machine or equipment.
- Any new, replacement, repair, or renovation to a machine must include an energy isolation device that can accept a lock out device.
- Lock out devices should not be used for any other purposes
- Verification of energy isolation is required



Standard Z244

- This applies to all machines
- Lockout / tagout is the primary method of hazardous energy control
- Machines shall be designed, manufactured, supplied, and installed with energy isolating devices



- B11.0 applies to a broad range of machines, B11.TR6 is specific to machine tools, and B155.1 is specific to packaging and converting machines
- Energy isolating device shall:
 - Be capable of being locked in the OFF position only
 - Be easy to operate
 - Have an exhaust port equal or greater than its supply port
 - Have a pressure indicator that is visible to an operator to verify line is relieved of pressure

...By offering the best in pneumatic safety for machine maintenance:



Traditional Ball Valve

- Not a dedicated energy isolation device** ✘
- Not a full exhaust port** ✘
- No verification of line exhaust** ✘
- Can be locked ON** ✘
- Not easily identifiable** ✘



Parker Solution

- ✓ Dedicated energy isolation device**
- ✓ Full exhaust port**
- ✓ Verification of line exhaust**
- ✓ Only lockable in OFF position**
- ✓ Easily identifiable**



For inventory, lead times, and kit lookup, visit www.pdnplu.com

Directair 2 & 4 Series

Viking Xtreme Lever Series

4/2 Lever / Pedal Series

M0 Series

Safety



Manual / Mechanical Valves

Brass Poppet / Sliding Seal

Control Panel Products

Sensing

Features / Part Numbers

LV / LVSS Series

Lockout valves are installed in pneumatic drop legs, or individual pneumatic control lines. In accordance with OSHA procedures, lockout valves are used during maintenance and service procedures of pneumatically (air) operated equipment.

- Used for compliance with OSHA 29 CFR part 1910
- 1/4" to 2" pipe sizes. NPT or BSPP
- Yellow cast aluminum body with red handle or stainless steel (NACE MR0175 / ISO 15156)
- Inline or surface mountable
- Built in port for pressure verification to meet ANSI B11 and PMMI B155 requirements
- Fluorocarbon slipper seals for easy shifting, even after long periods of inactivity



Material specifications



Description	LV	LVSS
Body:	Cast aluminum alloy	Stainless steel
Handle:	Plastic	Stainless steel
Spool:	Aluminum	Stainless steel
Seals:	Carboxylated nitrile	Fluorocarbon
Detent spring:	Stainless steel	Stainless steel
Grease:	Magnalube G [†]	Magnalube G [†]

[†] Trademark Magnalube

Operating information

Operating pressure:	LV	LVSS
Compact	15 to 145 PSIG	-
Standard	15 to 300 PSIG	15 to 300 PSIG
High flow	15 to 300 PSIG	-
Operating temperature:	40°F to 175°F	30°F to 175°F
Operating media:	Clean, dry, compressed air (5 micron)	

Compact

	Port In/Out	Port Exhaust	SCFM In/Out	SCFM Exhaust	Wt (lb)	Part Number *
	1/4	3/8	41.8	40.7	0.9	LV2N3B
	3/8	3/8	60.7	60.7	0.9	LV3N3B

Standard

	Port In/Out	Port Exhaust	SCFM In/Out	SCFM Exhaust	Wt (lb)	Part Number *
	3/8	3/4	107.7	81.1	2.0	LV3N6B
	1/2	3/4	161.4	90.9	2.0	LV4N6B
	3/4	3/4	187.7	93.2	2.0	LV6N6B
	3/4	1-1/4	297.7	204	3.2	LV6NAB
	1	1-1/4	375	216	3.2	LV8NAB
	1-1/4	1-1/4	436.4	221	3.2	LVANAB

High Flow

	Port In/Out	Port Exhaust	SCFM in/out	SCFM Exhaust	Wt (lb)	Part Number *
	1-1/2	2	761.4	1156	8.2	LVBNCB
	2	2	918.2	1186	8.2	LVCNCB

Stainless Steel

	Port In/Out	Port Exhaust	SCFM In/Out	SCFM Exhaust	Wt (lb)	Part Number *
	1/4	1/4	48.6	47.2	3.8	LV2N2BSS
	3/8	1/2	131.6	142	6.0	LV3N4BSS
	1/2	1/2	131.6	142	6.0	LV4N4BSS
	3/4	1	325	386	13	LV6N8BSS
	1	1	325	386	13	LV8N8BSS
	1-1/2	2	889	1023	35	LVBNCBSS
	2	2	889	1023	35	LVCNCBSS

NOTE: Exhaust flow rates calculated using inlet pressure 100 psig (6.7 bar), pressure drop 5 psi (0.34 bar), air temp 68°F (20°C), and 36% relative humidity.

* For BSPP ports, change 4th digit from "N" to "B"

Most popular.



For inventory, lead times, and kit lookup, visit www.pdnplu.com

Directair 2
& 4 Series

Viking Xtreme
Lever Series

42 Lever/
Pedal Series

M0 Series

Safety



Manual / Mechanical
Valves

Brass Poppet /
Sliding Seal

Control Panel
Products

Sensing

Features / Part Numbers

EZ Series

The EZ series meets all the same standards as the LV series with the added feature of a soft start when opened. There are still 2 detented positions for the handle (push close, pull to open), but when pulled open, an adjustable needle valve controls the rate of pressure build-up. This can protect equipment during start up after maintenance. The EZ is distinguishable from the LV series by the blue dot on the label.

Features

- Combines lockout and soft-start functions in a single unit
- Used in systems for compliance with OSHA standard 29 CFR part 1910
- 3/8 Inch to 1-1/4 inch pipe sizes
- Cv's from 3.7 to 13.7
- 3/4 and 1-1/4 inch: exhaust ports available
- Exhaust port threaded for installation of silencer or line for remote exhausting
- Inline or surface mountable
- Yellow cast aluminum body with red handle. Blue dot on body indicates EZ Series valve
- Fluorocarbon slipper seals for easy shifting, even after long periods of inactivity



3/4" Exhaust Shown

Operating information

Operating pressure:	15 to 300 PSIG
Standard	
Operating temperature:	40°F to 175°F
Operating media:	Clean, dry, compressed air (5 micron)

Material specifications

Description

Body:	Cast aluminum alloy
Handle:	Plastic
Spool:	Aluminum
Seals:	Carboxylated nitrile
Detent spring:	Stainless steel
Grease:	Magnalube G †

† Trademark Magnalube

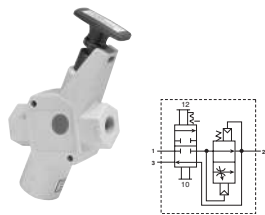

NOTE: Exhaust flow rates calculated using inlet pressure 100 psig (6.7 bar), pressure drop 5 psi (0.34 bar), air temp 68°F (20°C), and 36% relative humidity.

* For BSPP ports, change 5th digit from "N" to "B"

Most popular.



For inventory, lead times, and kit lookup, visit www.pdnplu.com

Directair 2 & 4 Series

Viking Xtreme Lever Series

4/2 Lever / Pedal Series

MO Series

Safety



Manual / Mechanical Valves

Brass Poppet / Sliding Seal

Control Panel Products

Sensing

Applications

Lockout valves are installed in pneumatic drop legs, or individual pneumatic control lines (see Figure 1). In accordance with OSHA procedures, EZ valves are used during maintenance and service procedures of pneumatically (air) operated equipment. Prior to servicing, the red handle is pressed inward, blocking pressure and relieving all downstream air pressure. A padlock is installed through the locking hasp, preventing accidental actuation during the maintenance procedure. Following maintenance, the padlock is removed and the red handle is pulled outward, gradually returning air pressure to the system. (For complete Lockout / Tagout procedures, consult OSHA Standard 29 CFR Part 1910 in U.S. Federal Register/Vol. 54 No. 169, Friday, September 1, 1989 / Page 36644.)

LV / LVSS Operation

Normal Machine Operation – Valve Open

With the handle pulled outward. Inlet Port 1 is open to outlet Port 2. Exhaust Port 3 is blocked.

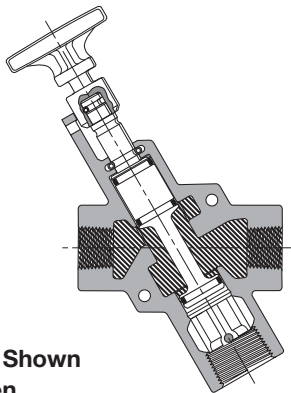

LV Series Shown Open

Mounting

Valves can be inline mounted or surface mounted using the two mounting holes provided in the valve body. Mount valves in plain view with the handle oriented for accessibility.

Placement of Lockout Device

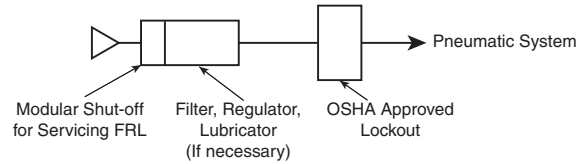
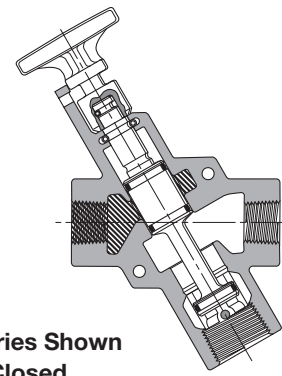

Figure 1.

Lockout Operation – Valve Closed

With the handle pushed inward. Inlet Port 1 is blocked. Outlet Port 2 is open to Exhaust Port 3.



LV Series Shown Closed

EZ Operation

Normal Machine Operation – Valve Open

When the red handle is pulled outward, the adjustable needle valve (accessed through the top of the handle) setting determines the rate of pressure buildup. When downstream pressure reaches the full flow described in the specifications below, Inlet Port 1 is open to outlet Port 2. Exhaust Port 3 is blocked.

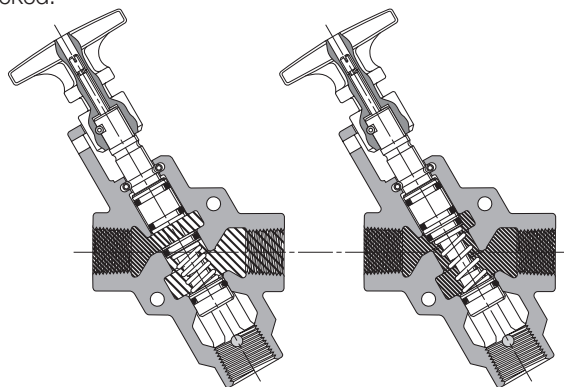

Open Pressure Building Up

Open Full Flow

Lockout Operation – Valve Closed

When the red handle is pushed inward, the Inlet Port 1 is blocked. Downstream air is exhausted through Exhaust Port 3.

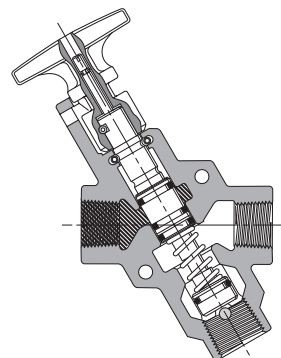

Closed



For inventory, lead times, and kit lookup, visit www.pdnplu.com

Directair 2 & 4 Series
Viking Xtreme Lever Series
42 Lever / Pedal Series
M0 Series
Safety
M
Manual / Mechanical Valves
Brass Poppet / Sliding Seal
Control Panel Products
Sensing

Accessories

Corrosion resistant mufflers for harsh environments



Port Size	Construction	Threads	Dimensions In. (mm)		Part Number
			Width	Length	
1/4	Stainless steel	Male, NPT	0.56 (14.2)	1.75 (44.5)	5500A2004
1/2	Stainless steel	Male, NPT	0.87 (22.1)	2.75 (69.7)	5500A4004
1	Stainless steel	Male, NPT	1.31 (33.3)	3.87 (98.3)	5500B6004
2	Nickel plated	Male, NPT	2.37 (60.2)	5.50 (139.7)	5500A9004*

* Nickel plated



* NPT ports standard, for BSPT ports, add a "B" after the "S"

Pop-up Pressure Indicator



Brass – Part # **988A30** – Can be used on all LV or EZ series to provide visual verification of line exhaust



Stainless – Part# **1155H30** – Can be used on SS LV series to provide visual verification of line exhaust

Pressure Switch



- Part # **PPS1-2C3-RHM** (DIN 9.4mm connector)
- Part # **PPS1-2C3-RWL** (18" leads)
- Signal verification of line exhaust
- Field adjustable set point

Directair 2 & 4 Series
 Viking Xtreme Lever Series
 42 Lever / Pedal Series
 MO Series
 Safety
 Manual / Mechanical Valves
 Brass Poppet / Sliding Seal
 Control Panel Products
 Sensing



For inventory, lead times, and kit lookup, visit www.pdnplu.com

LZ Series, Exhaust Port - Compact, Standard, High Flow

Compact

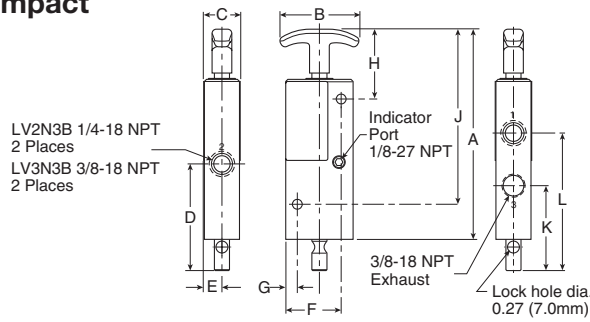

Compact LV Series, 3/8" Exhaust Port Dimensions

A	B	C	D	E	F
6.50 (165)	2.25 (57)	1.05 (27)	3.04 (77)	.51 (13)	1.58 (40)
G	H	J	K	L	
.33 (8)	1.99 (51)	4.99 (127)	2.42 (62)	3.92 (100)	

Inches (mm)

Standard

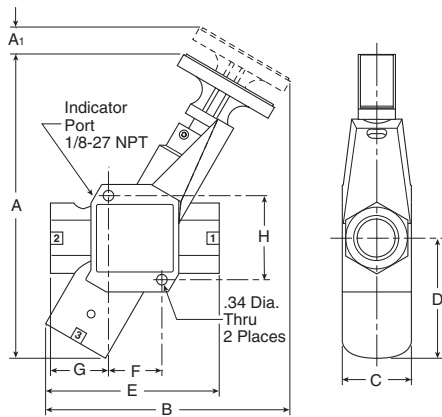

Compact LV Series, 3/4" Exhaust Port Dimensions

A	A ₁	B	C	D	E
8.32 (211)	0.64 (16)	6.60 (168)	2.00 (51)	3.06 (78)	4.24 (108)
F	G	H			
1.32 (111)	1.56 (40)	2.21 (56)			

Inches (mm)

Compact LV Series, 1-1/4" Exhaust Port Dimensions

A	A ₁	B	C	D	E
9.91 (252)	0.85 (22)	7.95 (202)	2.25 (57)	3.91 (99)	5.65 (144)
F	G	H			
1.74 (44)	1.89 (48)	2.74 (70)			

Inches (mm)

High Flow

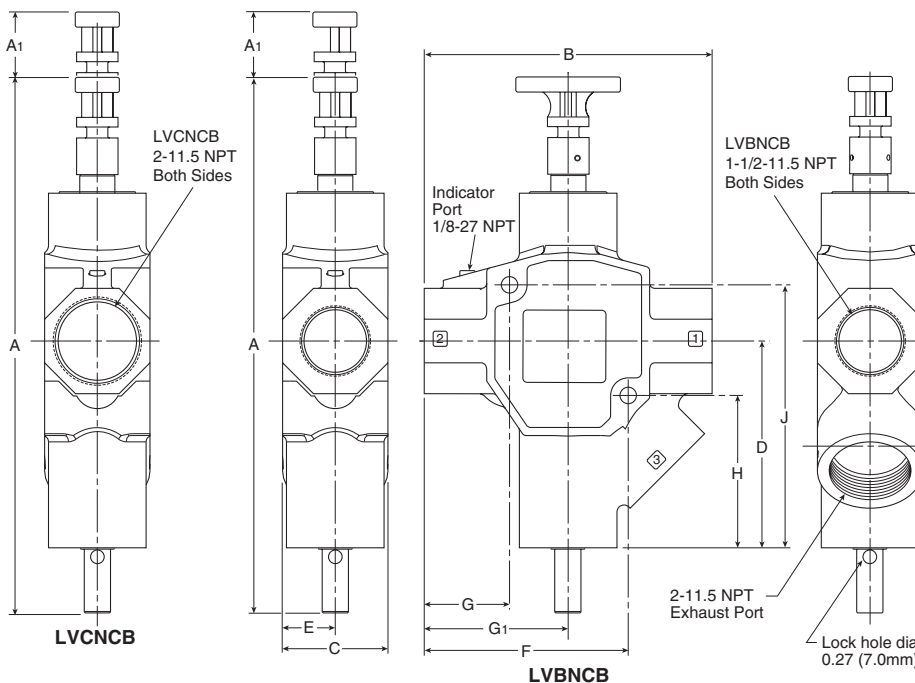

High Flow LV Series, 2" Exhaust Port Dimensions

A	A ₁	B
14.82 (376)	1.87 (47)	8.20 (208)
C	D	E
3.00 (76)	5.89 (150)	1.50 (38)
F	G	G ₁
5.81 (148)	2.43 (62)	4.10 (104)
H	J	
4.34 (110)	7.49 (190)	

Inches (mm)

Dimensional Data

LZ Series, Exhaust Port - Compact, Standard, High Flow

Stainless Steel

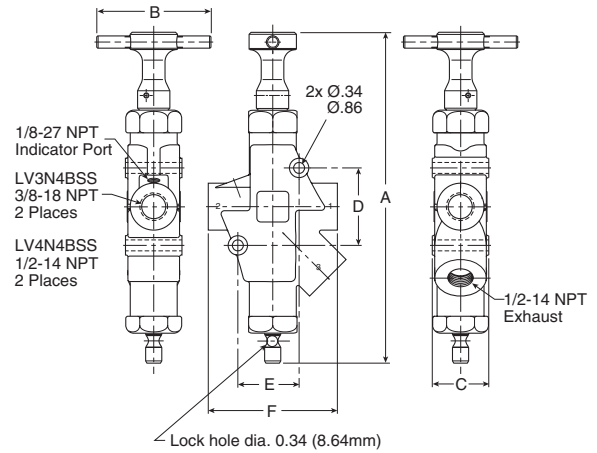
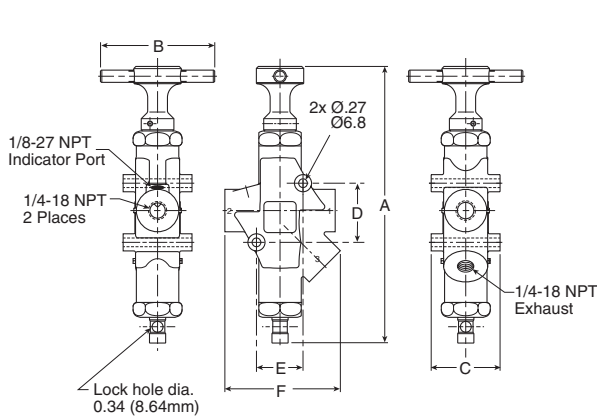

Stainless Steel LV Series, 1/4" Exhaust Port Dimensions

A	B	C	D	E	F
8.47	3.50	2.11	1.81	1.43	3.54
(215)	(89)	(54)	(46)	(36)	(90)

Inches (mm)

Stainless Steel LV Series, 1/2" Exhaust Port Dimensions

A	B	C	D	E	F
10.24	3.50	1.75	2.40	1.90	4.00
(260)	(89)	(45)	(61)	(48)	(102)

Inches (mm)

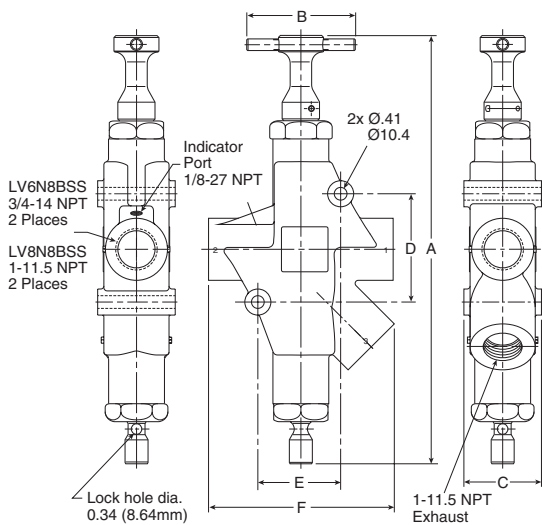

Stainless Steel LV Series, 1" Exhaust Port Dimensions

A	B	C	D	E	F
13.80	3.50	2.50	3.49	2.67	5.99
(351)	(89)	(64)	(89)	(68)	(152)

Inches (mm)

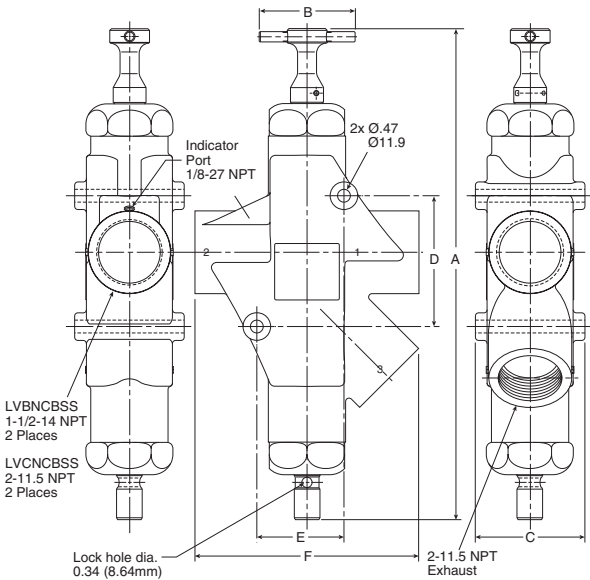

Stainless Steel LV Series, 2" Exhaust Port Dimensions

A	B	C	D	E	F
17.92	3.50	4.00	4.77	3.18	8.16
(455)	(89)	(102)	(121)	(81)	(207)

Inches (mm)

Directair 2
& 4 Series

Viking Xtreme
Lever Series

42 Lever /
Pedal Series

MO Series

Safety



Manual / Mechanical
Valves

Brass Poppet /
Sliding Seal

Control Panel
Products

Sensing



For inventory, lead times, and kit lookup, visit www.pdnplu.com

EZ Series, Exhaust Port - Standard Flow

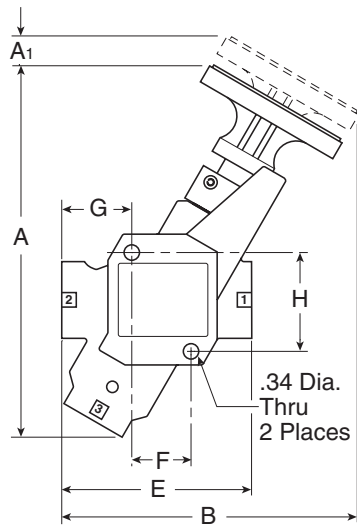

EZ 3/4" Exhaust Port Dimensions

A	A1	B	C	D
8.32 (211)	0.64 (16)	6.60 (168)	2.00 (51)	3.06 (78)

E	F	G	H
4.24 (108)	1.32 (111)	1.56 (40)	2.21 (56)

Inches (mm)

EZ 1-1/4" Exhaust Port Dimensions

A	A1	B	C	D
9.91 (252)	0.85 (22)	7.95 (202)	2.25 (57)	3.91 (99)

E	F	G	H
5.65 (144)	1.74 (44)	1.89 (48)	2.74 (70)

Inches (mm)

Features

Two-Hand Controls

Two-Hand Controls

- The pre-assembled two-hand control enclosure occupies both hands of an operator by requiring nearly simultaneous operation of two pushbuttons
- Poppet – snap-acting (no spools)
- Same air as in cylinders – Filtration: 40 micron
- No lubrication required



Part number	Connection
PXP-C111-A	5/32" Instant

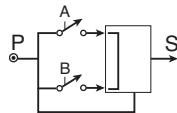

General Characteristics

Operating Pressure	40 to 120 PSI (3 to 8 bar)
Permissible Fluids –	Air or neutral gas 40 micron filtration, lubricated or dry
Flow at 90 PSI (6 bar)	7 SCFM (200 l/mn ANR)
Operating Temperature	-5°F to 140°F (-15°C to 60°C)
	Below 40°F (5°C), an air dryer is required
Storage Temperature	-40°F to 160°F (-40°C to 70°C)
Number of operations with dry air at 90 PSI (6 bar), 68°F (20°C), frequency 1 Hz	1 Million Operations
Vibration resistance –	Conforms to section 19-2 of bureau Véritas regulations (November 1987)
Materials –	Body Glass Filled Nylon
	Operating Head Zinc Alloy and Plastic
Connections:	5/32" instant

Mounting

Approvals:

- In accordance with European Standard EN 574 - September 1996
- Conforms to the model that has obtained CE Type Test Certificate No. 02526 520 4631 0397

WARNING

These devices should **NOT** be used in any application involving rotary clutch presses. Two hand control modules do not of themselves insure the safety of any machine. Users and original equipment manufacturers are responsible for making sure that installations meet all relevant safety regulations.

Notes: These two-hand control modules provide an output signal upon nearly concurrent operation of two pushbuttons.

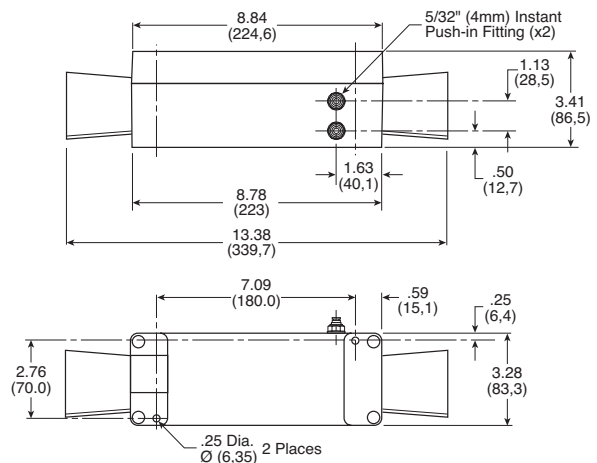

Inches (mm)



For inventory, lead times, and kit lookup, visit www.pdnplu.com

Directair 2 & 4 Series

Viking Xtreme Lever Series

42 Lever / Pedal Series

M0 Series

Safety



Manual / Mechanical Valves

Brass Poppet / Sliding Seal

Control Panel Products

Sensing

Two-Hand Control Module

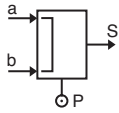

S = Output
 AdB = Momentary input
 P = Pressure supply



PXP-A11-A

Part number	Connection
PXP-A11-A	5/32" Instant

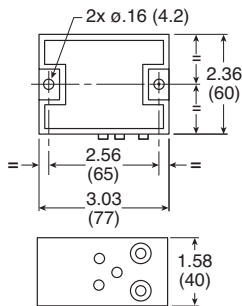

Specifications

Air Quality –	Standard Shop Air, Lubricated or Dry	40 µm Filtration
Materials –	Body	Polyamide
	Operating Head	Zinc Alloy & Plastic
Flow at 90 PSI (6 bar) in SCFM (l/mn ANR)		7 (200)
Number of Operations with Dry Air at 90 PSI (6 bar) and 68°F (20°C) - Frequency 1 Hz		1 million Operations
Operating Positions		All Positions
Operating Pressure –		15 to 115 PSIG (1 to 8 bar)
Ports	5/32" Instant for Semi-Rigid Nylon or Polyurethane Tube	
Operating Temperature –	Operating	32°F to 122°F (0°C to 50°C)
	Storage	-22°F to 140°F (-30°C to 60°C)
Vibration resistance:	Conforms to section 19-2 of bureau Véritas regulations (November 1987)	

⚠ WARNING

These devices should **NOT** be used in any application involving rotary clutch presses. Two hand control modules do not of themselves insure the safety of any machine. Users and original equipment manufacturers are responsible for making sure that installations meet all relevant safety regulations.

Notes: These two-hand control modules provide an output signal upon nearly concurrent operation of two pushbuttons.

Two-Hand Control Module Guard



PPRL15

Part number	Base component
PPRL15	PXP-C111-A

Two Hand Repair Parts

Part number	Quantity required	Description
PXP-A11-A	1	Control Module
PXBB4931	2	Valve Body & Mounting Ring
ZB4BR*	2	Push Button
PPRL15	2	Control Module Guard

* 2 = Black, 3 = Green, 4 = Red



For inventory, lead times, and kit lookup, visit www.pdnplu.com

Directair 2
& 4 Series

Viking Xtreme
Lever Series

42 Lever/
Pedal Series

M0 Series

Safety



Manual / Mechanical
Valves

Brass Poppet /
Sliding Seal

Control Panel
Products

Sensing

Features / Part Numbers

PL / VL Series

These are 4-Way, 3-Position, rotary disc, direct-operated air valves. Two different types of control are offered. The forged bronze disc and the cast iron surface upon which the disc works are ground and lapped to provide a leak-proof seal. Air pressure from the inlet port is confined beneath the disc, making the seal tighter as the pressure increases, yet friction between the lapped surfaces is so low that only 15 pounds of force is required to move the lever at 100 PSI line pressure. The need for packing to seal around the stem is eliminated.

Valve can be furnished for gasketing to a manifold on customer's machine or with an adaptor for tapped bottom porting.

Valves are detented.

Operating handles may be installed in any of four positions.



Operating information

Operating pressure: 0 to 150 PSI (0 to 1035 kPa)

Temperature range: 18°F to 200°F (-8°C to 93°C)

Lubrication: Filtered and lubricated air recommended for maximum valve life and minimum maintenance.

PL Series Valves

This type has a 90° lever movement. In neutral position, inlet is closed to pressure – outlets closed to exhaust. With clockwise (CW), inlet is connected to cylinder port directly opposite. Other cylinder port is connected to exhaust. With counterclockwise (CCW), inlet is connected to cylinder port diagonally opposite. Other cylinder port is connected to exhaust. Recommended for stationary air cylinders, arbor presses, and as a throttling valve for positioning air cylinders.

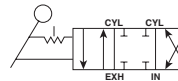

Port Size	Description	Cv	Part Number
3/8" NPT	4-Way, 3-Position, Detent, Closed Center	3.0	PL37
1/2" NPT	4-Way, 3-Position, Detent, Closed Center	6.2	PL50

VL Series Valves

This type has a 90° lever movement. In neutral position, inlet is closed to pressure – outlets open to exhaust. With clockwise (CW), inlet is connected to cylinder port directly opposite. Other cylinder port is connected to exhaust. With counterclockwise (CCW), inlet is connected to cylinder port diagonally opposite. Other cylinder port is connected to exhaust. This valve is particularly suited for pneumatic chuck operation.

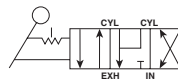

Port Size	Description	Cv	Part Number
3/8" NPT	4-Way, 3-Position, Detent, Exhaust Center	3.0	VL37
1/2" NPT	4-Way, 3-Position, Detent, Exhaust Center	6.2	VL50

Service kits

Description	Valve Size	Part Number
Lever Assembly	PL37, PL37HP, VL25, & VL37	PL2425P
Service Kits	PL50, PL50HP & VL50	PL2424P
Body Gasket	PL37, PL37HP, VL25, & VL37	P66837
	PL50, PL50HP & VL50	P66829

Most popular.



For inventory, lead times, and kit lookup, visit www.pdnplu.com

Directair 2 & 4 Series

Viking Xtreme Lever Series

4/2 Lever / Pedal Series

MO Series

Safety



Manual / Mechanical Valves

Brass Poppet / Sliding Seal

Control Panel Products

Sensing

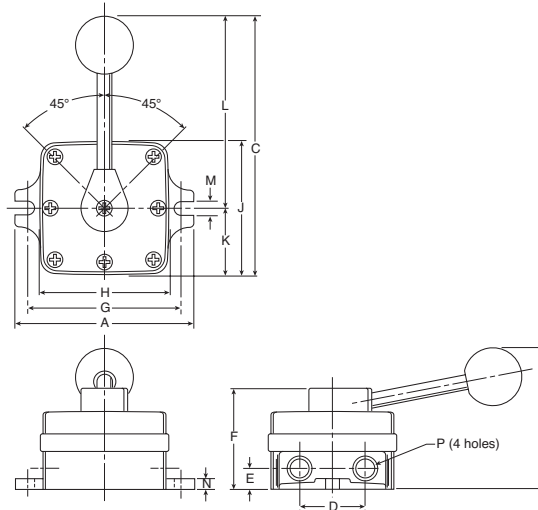

PL-VL Dimensions

	A	B	C	D	E	F	G	H	J	K	L	M	N	P
PL37	4.75	3.81	6.81	1.69	.56	2.75	4.12	3.50	3.50	1.69	5.06	.34	.28	3/8
VL37	(121)	(97)	(173)	(43)	(14)	(70)	(105)	(89)	(89)	(43)	(129)	(9)	(7)	NPT
PL50	5.62	4.44	8.94	2.12	.66	3.25	5.00	4.38	4.38	2.12	6.75	.34	.34	1/2
VL50	(143)	(113)	(227)	(54)	(17)	(83)	(127)	(111)	(111)	(54)	(171)	(9)	(9)	NPT

inches (mm)



Features / Part Numbers

HV Valve Series

- Compact and simple design
- Rotary disc, direct operated valves
- Side porting
- Detent action smooth lever actuation
- General pneumatic applications



Material specifications

Cover	Zinc
Body	Aluminum
Seals	Polyurethane

Operating information

Operating pressure: 0 to 150 PSI (0 to 10 bar)
 Temperature range: 32°F to 166°F (0°C to 60°C)
 Lubrication: Filtered and lubricated air recommended for maximum valve life and minimum maintenance.

HV Series Valves

These closed center valves have a 90° lever movement. In neutral position, the inlet is closed to pressure and outlets are closed to exhaust. With clockwise (CW) rotation, inlet (IN) is connected to C2, C1 is connected to exhaust (EXH). With counter-clockwise (CCW) rotation, inlet (IN) is connected to C1, C2 is connected to exhaust (EXH). These valves are recommended for stationary air cylinders, and as throttling valves for positioning air cylinders. They are not to be used on punch presses or press brakes.

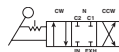

Port Size	Description	Cv (ANSI)	Cv (JIS)	Part Number
1/4" NPT	4-Way, 3-Position	0.5	0.4	HVN4200-8
3/8" NPT	4-Way, 3-Position	1.4	2.72	HVN4400-10
1/2" NPT	4-Way, 3-Position	1.5	3.26	HVN4400-15

HVN4200-8

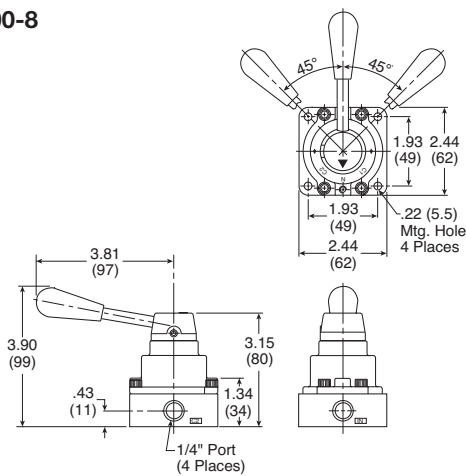

HVN4400-10, 15

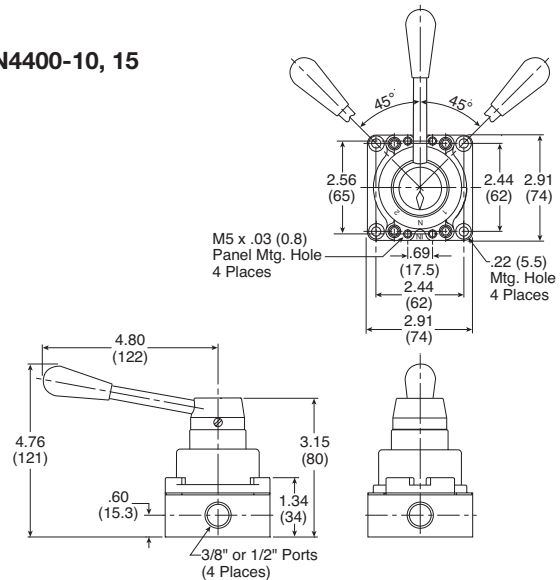

Service kits

Description	Valve Size	Part Number
Disk & Seal	HV4200	HVRK420001
Service Kits	HV4400	HVRK440001

ANSI Cv vs. JIS Cv

For Pneumatic Valve flow, the measurement Cv – Coefficient of Flow – is used to convey to the user how much air can flow through a given valve. Most valve manufacturers publish this information in their catalogs to assist the user in choosing the proper valve for their application. In publishing this data however, there are discrepancies in how the Cv is calculated, resulting in some Cv's being OVERSTATED by 20 to 40%. This can adversely affect the user's application because the valve flows LESS than the published Cv.

The reason for the large discrepancy is in the method of calculation - the ANSI (NFPA) or the JIS standard. Parker's Cv valve is calculated using the ANSI (NFPA) T3.21.3-1990 standard. The ANSI (NFPA) method is a structured test using very specific tube sizes and lengths, inlet pressures and pressure drops, and volume chambers.

Most popular.



For inventory, lead times, and kit lookup, visit www.pdnplu.com

Directair 2 & 4 Series

Viking Xtreme Lever Series

4/2 Lever / Pedal Series

MO Series

Safety



Manual / Mechanical Valves

Brass Poppet / Sliding Seal

Control Panel Products

Sensing

Features / Part Numbers

Hand Operated Sliding Seal Valves

Sliding seal valves provide 3 or 4-Way directional control in a compact body size. Comfortable hand lever is easy to operate and maintains set position. Disc type valve has minimum number of moving parts. Valves should be used with filtered and lubricated air.

CAUTION:
Install guards on all hand operated valves.
Accidental operation can cause personal injury.

Material specifications

Internal components	Brass, stainless steel
Body	Die cast zinc
Seals	Buna N

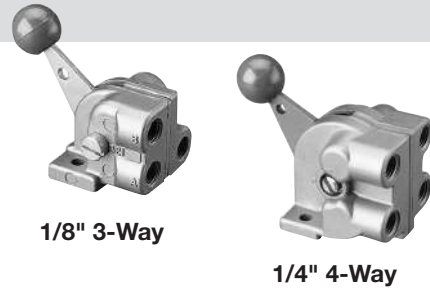

1/8" 3-Way

1/4" 4-Way

Operating information

Operating pressure: Max. 200 PSIG air only
Min. 26" Hg vacuum
Temperature range: -40°F to 212°F (-40°C to 100°C)
(If it is possible that the ambient temperature may fall below freezing, the medium must be moisture free to prevent internal damage or unpredictable behavior.)

Hand Operated Sliding Seal Valve

Symbol	Port Size	Function	Cv (Avg)	Service Kit*	Part Number
	1/8"	3-Way, 2-Position, Detented	0.54	032130899	032130599
	1/8"	4-Way, 2-Position, Detented	0.54	032130899	032140299
	1/4"	4-Way, 3-Position, Detented, Center Blocked	1.25	008230299	008240109

Note: 3-Way exhaust passage is through an untapped hole in bottom side of valve.

1/8" 3-Way 032130599

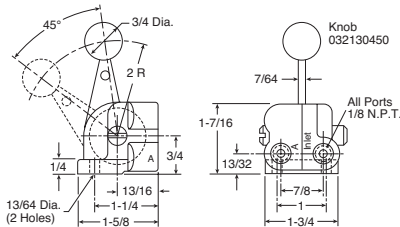

Service Kit 032130899*

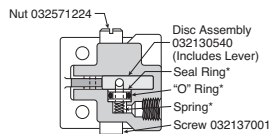

1/8" 4-Way 032140299

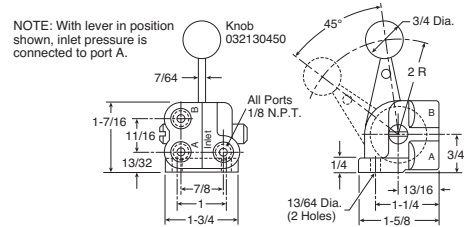

Service Kit 032130899*

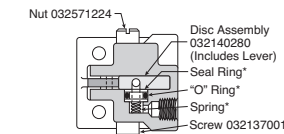

1/4" 4-Way 008240109

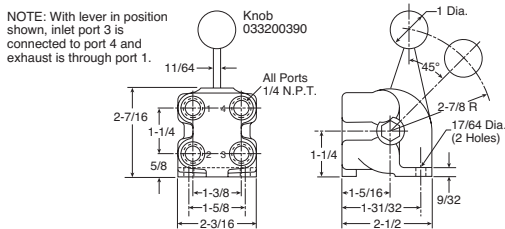

Service Kit 008230299*

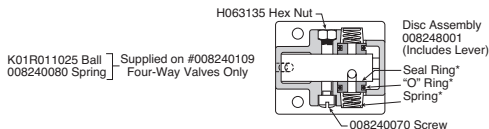

Most popular.

* Service kits contain asterisk items



For inventory, lead times, and kit lookup, visit www.pdnplu.com

Directair 2
& 4 Series

Viking Xtreme
Lever Series

42 Lever/
Pedal Series

M0 Series

Safety



Manual / Mechanical
Valves

Brass Poppet /
Sliding Seal

Control Panel
Products

Sensing

Features / Part Numbers

Button Operated Valves

2 & 3-way normally closed poppet, 1/4" Port valve operates at the press of a button and may be installed in a pipe line or used as a portable blow gun attached to a length of hose.

CAUTION:
 Install guards on all hand operated valves.
 Accidental operation can cause personal injury.



Material specifications

Internal components	Brass, stainless and plated steel
Body	Brass
Seals	Buna N

Operating information

Operating pressure:	Max. 150 PSIG air only Min. 0 PSIG
Temperature range:	-20°F to 180°F (-28°C to 82°C)

Button Operated Valves

	Port Size	Function	Cv (Avg)	Old Number	Service Kit	Part Number
	1/4"	2-way	0.94	7796SP1	077960105	077960199
	1/4"	3-way	0.94	8187	077960105	081870129

Dimensions

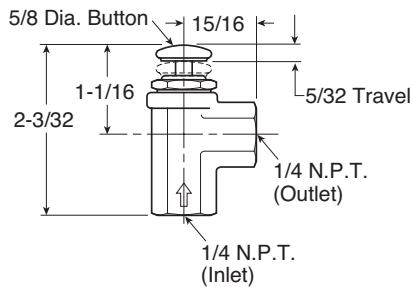

Replacement Parts

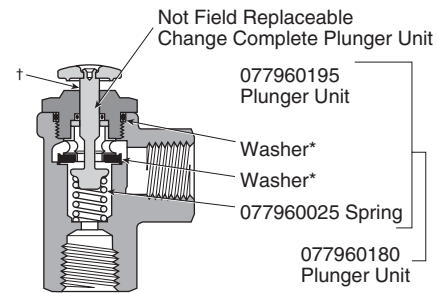

† 077960199 2-Way valve shown.
 * Included in service kits listed above.



For inventory, lead times, and kit lookup, visit www.pdnplu.com

Directair 2 & 4 Series

Viking Xtreme Lever Series

42 Lever / Pedal Series

MO Series

Safety



Manual / Mechanical Valves

Brass Poppet / Sliding Seal

Control Panel Products

Sensing

Hand / Cam Operated Valves

Inline, button-operated, 2 & 3-way normally closed poppet, 1/4" port valve has mounting holes for single or gang mounting. Actuation by hand, cam or mechanical fingers. Valves should be used with filtered and lubricated air.



CAUTION:

Install guards on all hand operated valves. Accidental operation can cause personal injury.



Operating information

Operating pressure: Max. 150 PSIG air only
Min. 0 PSIG
Temperature range: -20°F to 180°F (-28°C to 82°C)

Hand / Cam Operated Valves

	Port Size	Function	Cv (Avg)	Old Number	Service Kit	Part Number
	1/4"	2-Way	0.94	7796SP5	077960105	077960319
	1/4"	3-Way	0.94	8187SP1	077960105	081870139

Replacement Parts

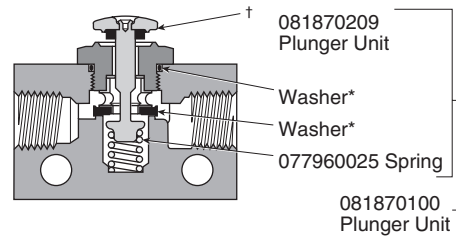
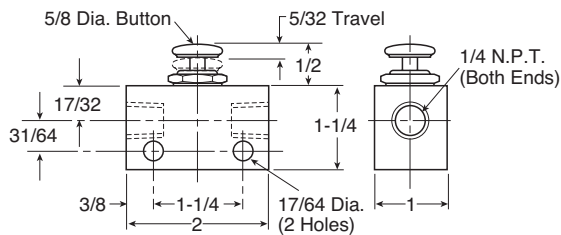

† 081870139 3-Way valve shown.
* Included in service kits listed above.



Features / Part Numbers

Bleed Valves

This 2-way normally closed bleeder valve is an accessory that may be used with any double pilot-operated valve (bleed type). It provides manual or cam-operated control. A 1/4" pipe thread fits either the pilot valve port or the feeder airline. Opposite end has standard 1/2-20 thread for easy mounting on machine or panel. Valves should be used with filtered and lubricated air.



Material specifications

Internal components	Brass, stainless steel
Body	Brass
Seals	Fluorocarbon

Operating information

Operating pressure:	Max. 150 PSIG air only Min. 0 PSIG
Temperature range:	-40°F to 450°F (-40°C to 232°C)

Bleed Valves

	Port Size	Function	Part Number
	1/4"	2-way	315139000

Dimensions

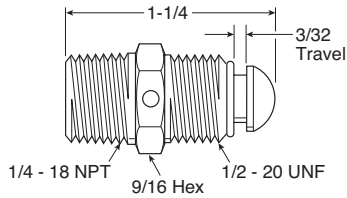

Directair 2 & 4 Series
Viking Xtreme Lever Series
4/2 Lever / Pedal Series
MO Series
Safety
Manual / Mechanical Valves
Brass Poppet / Sliding Seal
Control Panel Products
Sensing



For inventory, lead times, and kit lookup, visit www.pdnplu.com

Control Panel Products

HUMAN-MACHINE DIALOG requires devices such as push buttons and selector switches to provide command inputs. A wide variety of these devices are available to meet most application needs; in both pneumatic and electrical switch bodies. All of these devices use the 22 mm (7/8") mounting standard.



Complete Assemblies— 3/2 Valve Bodies with 5/32" Instant Straight Connections

Flush Push Buttons

	Color	Function	Type of Switching*	Part Number
	Black			PXBB3111BA2
	Green	Spring Return	NNP	PXBB3111BA3
	Red			PXBB3111BA4
	Black	Spring Return	NNP+NP	PXBB3251BA2
	Black		Single	PXBB4131BA2
	Green	Spring Return	Universal 3-Way	PXBB4131BA3
	Red			PXBB4131BA4
	Black	Spring Return	Dual Universal 3-Way	PXBB4231BA2

* Type of switching: Universal 3-way: valve can be connected either as NP or NNP as required by connecting the primary air supply to port 1 or port 3.

Note: Mount up to three valves on mounting ring.

Mushroom Head Push Buttons (40mm Diameter)

	Color	Function	Type of Switching*	Part Number
	Black	Spring Return	NNP	PXBB3111BC2
	Red	Push-Pull		PXBB3111BT4
	Red	Push-Pull	NP	PXBB3121BT4
	Black	Spring Return	Single Universal 3-Way	PXBB4131BC2
	Red	Push-Pull		PXBB4131BT4

* Type of switching: Universal 3-way: valve can be connected either as NP or NNP as required by connecting the primary air supply to port 1 or port 3.

Note: Mount up to three valves on mounting ring.

Selector Switches

	Color	Function	Type of Switching*	Part Number
	Black	2 Maintained Positions with Std. Handle	NNP	PXBB3111BD2
	Black		NNP+NP	PXBB3211BD2
	Black		NNP+NP	PXBB3251BD2
	Black	3 Maintained Positions with Cdle	NNP+NP	PXBB3211BD3
	Black		NNP+NP	PXBB3251BD3
	Black	3 Positions, Spring Return to Center with Long Handle	NNP+NP	PXBB3211BJ5
	Black	2 Maintained Positions with Std. Handle	Single Universal 3-Way	PXBB4131BD2
	Black	2 Maintained Positions with Std. Handle	Dual Universal 3-Way	PXBB4231BD2
	Black	3 Maintained Positions with Std. Handle	Dual Universal 3-Way	PXBB4231BD3
	Black	3 Maintained Positions with Long Handle	Dual Universal 3-Way	PXBB4231BJ5

* Type of switching: Universal 3-way: valve can be connected either as NP or NNP as required by connecting the primary air supply to port 1 or port 3.

Most popular.



For inventory, lead times, and kit lookup, visit www.pdnplu.com

Directair 2
& 4 Series

Viking Xtreme
Lever Series

42 Lever/
Pedal Series

M0 Series

Safety



Manual / Mechanical
Valves

Brass Poppet /
Sliding Seal





Control Panel
Products

Sensing

Accessories

For Use With PXBB Valve Bodies and ZBE Electrical Switch Bodies

Push Buttons



	Color	Function	Type	Part Number	Plastic Head**	Metal Head*
	Black		Flush	ZB5AA2	ZB4BA2	
	Green			ZB5AA3	ZB4BA3	
	Red	Spring Return		ZB5AA4	ZB4BA4	
	Yellow			—	ZB4BA5	
	Blue			—	ZB4BA6	
	Black		Extended	ZB5AL2	ZB4BL2	
	Green	Spring Return		ZB5AL3	ZB4BL3	
	Red	Spring Return		ZB5AL4	ZB4BL4	
	Yellow			—	ZB4BL5	
	Black		Booted	—	ZB4BPA2	
	Green	Spring Return		—	ZB4BPA3	
	Red			—	ZB4BP4	
	Black		Flush	—	ZB4BH02	
	Green	Detent 2 Position		—	ZB4BH03	
	Red			—	ZB4BH04	

* ZB4*** model numbers are metal head operators
** ZB5*** model numbers are plastic head operators, use with plastic mounting ring.



For Push Buttons and Visual Indicators

Mounting Ring for Valve Bodies, Switch Bodies and Operating Heads

Description	Part Number
 Metal Mounting Ring	ZB4BZ009
 Plastic Mounting Ring	ZB5AZ009

Note: To release push button from mounting ring, pull lever on top of mounting ring up and remove push button operator. To assemble push button operator to mounting ring, align arrows and snap into place.

Selector Switches

Standard black handle

Description	Function	Part Number*
Maintained		ZB4BD2
Spring Return from Right to Left	2 positions	ZB4BD4
Maintained		ZB4BD3
Spring Return to Center from Left and Right	3 positions	ZB4BD5
Maintained Right Spring Return from Left to Center	3 positions	ZB4BD7
Maintained Left Spring Return from Right to Center	3 positions	ZB4BD8

Long Black Handle

Maintained		ZB4BJ2
Spring Return from Right to Left	2 positions	ZB4BJ4
Maintained		ZB4BJ3
Spring Return to Center from Left and Right	3 positions	ZB4BJ5

* ZB4*** model numbers are metal head operators

Key Operated Selectors

Key Withdrawal	Function	Part Number*
Left	2 Maintained Positions	ZB4BG2
Left and Right		ZB4BG4
Center	3 Maintained Positions	ZB4BG3
Left and Right		ZB4BG5
Center	3 Positions 2 Spring Return to Center	ZB4BG7

* ZB4*** Model numbers are metal head operators

Mushroom Head Push Buttons with Key Select

Color	Function	Description	Part Number*
Red	Latching Turn to Release	Ø 40mm head	ZB4BS844
Red	Key Latching		ZB4BS944

* ZB4**** model numbers are metal head operators

 Most popular.



For inventory, lead times, and kit lookup, visit www.pdnplu.com

Directair 2 & 4 Series
Viking Xtreme Lever Series
42 Lever / Pedal Series
M0 Series
Safety
Manual / Mechanical Valves
Brass Poppet / Sliding Seal
Control Panel Products
Sensing

For Use With 2B4* Metal Operating Heads**



PXBB3111B



PXBB4131B

* NNP: Normally non-passing.

Note: Mount up to 3 valves on mounting ring for push buttons.
Mount up to 2 valves on mounting ring for selector switches, valves cannot be mounted in center position.

Specifications

Air Quality – Standard Shop Air, Lubricated or Dry	40 µm Filtration
Flow –	PXBB3• Cv=.08
	PXBB4• Cv=.18
Materials –	Body Polyamide
	Operating Head Zinc Alloy & Plastic
Operating Positions	All Positions
Operating Pressure –	PXBB3• 15 to 115 PSIG (1 to 9 bar)
	PXBB4• 15 to 145 PSIG (1 to 10 bar)
Ports	5/32" Instant for Semi-Rigid Nylon or Polyurethane Tube
Operating Temperature –	5°F to 140°F (-15°C to 60°C)

Additional Valve Bodies



PXBB3911



PXBB4932



PXBB4931

Connections	Function	Type of Switching*	Part Number
5/32" instant straight	3/2	NNP	PXBB3911
5/32" instant swivel			PXBB3912
5/32" instant straight	3/2	NP	PXBB3921
5/32" instant swivel			PXBB3922
5/32" instant straight	3/2	Universal	PXBB4931
5/32" instant swivel			PXBB4932

* NNP: Normally non-passing.

Most popular.



For inventory, lead times, and kit lookup, visit www.pdnplu.com

Directair 2
& 4 Series

Viking Xtreme
Lever Series

42 Lever/
Pedal Series

M0 Series

Safety



Manual / Mechanical
Valves

Brass Poppet /
Sliding Seal

Control Panel
Products

Sensing

Accessories

For Push Buttons and Visual Indicators

Legend Plates for PXBB Devices (22mm)

Description	Part Number
Without Text for Customer Engraving	
Black / red background (white letters)	ZBY2101
Yellow / white background (black letters)	ZBY4101
With Text for Push Buttons	
Start	ZBY2303
Stop	ZBY2304
Forward	ZBY2305
Reverse	ZBY2306
Up	ZBY2307
Down	ZBY2308
On	ZBY2311
Off	ZBY2312
Open	ZBY2313
Close	ZBY2314
Inch	ZBY2321
Reset	ZBY2323
Power On	ZBY2326
Slow	ZBY2327
Fast	ZBY2328
Emergency stop	ZBY2330
Run	ZBY2334
With Text for 2-Position Selectors	
Off On	ZBY2367
With Text for 3-Position Selectors	
Hand Off Auto	ZBY2387



Blank Legend Plates for Inscription

For PXBB devices (2 lines of 11 characters maximum)

Please indicate the required text when ordering.

Description	Part Number
Black Background / White Letters	ZBY2002

For 22mm Visual Indicators Only

2 lines of 11 characters maximum

Please indicate the required text when ordering.

Description	Part Number
Black Background / White Letters	ZB2BY2002

Electrical Switch Bodies

When combined with pneumatic valves, these contact blocks allow different forms of power to be provided from a single push button. Can be mounted with both types of valves PXBB3 / PXBB4.

Type of contact	Part Number
Normally Open (NO)	ZBE101
Normally Closed (NC)	ZBE102



Note: Plastic mounting ring ZB5AZ009 to be used with ZB5 plastic operating heads. Metal mounting ring ZB4BZ009 to be used with ZB4 metal operating heads.

Electrical specification: 240V, 10 Amp

Most popular.



For inventory, lead times, and kit lookup, visit www.pdnplu.com

Directair 2 & 4 Series

Viking Xtreme Lever Series

42 Lever / Pedal Series

M0 Series

Safety



Manual / Mechanical Valves

Brass Poppet / Sliding Seal

Control Panel Products

Sensing

Pneumatic Visual Indicators

An indicator ball is rotated by a pneumatic input, changing the visible color. The ball sits behind a clear plastic window, providing a wide field of view. The visual indicators are available in five brightly colored Day-Glow paints for increased visibility. Like push buttons and selector switches, visual indicators use the 22mm (7/8") mounting standard.

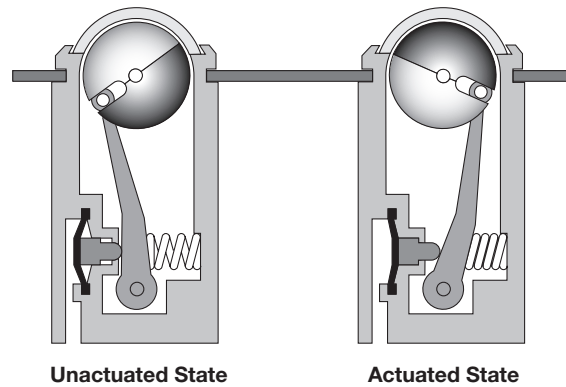

With 5/32" Instant Connections



Notes: The Pneumatic Indicators are black in one position and colored in the other. The colored position corresponds either to the presence of a pressure ("ON" Indicator) or the absence of pressure ("OFF" Indicator).

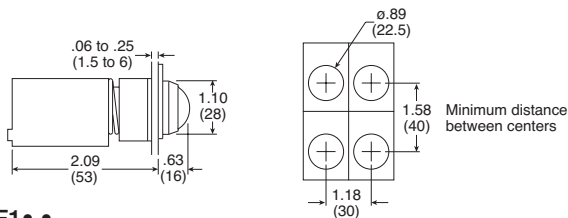

PXVF1 • •

Mounting Accessories

	Color	Description	Part Number
	—	Plastic Head (ZB5) Mounting Nut Tightening Tool	ZB5AZ905
	Black Plastic	Guard for 40mm	ZBZ1602

Specifications

Air Quality –	Standard Shop Air, Lubricated or Dry 40 µm Filtration	
Materials –	Body	Polyamide
	Operating Head	Zinc Alloy & Plastic
Number of Operations with Dry Air at 90 PSI (6 bar) and 68°F (20°C) - Frequency 1 Hz	Mushroom Head	300,000 Operations
	Mushroom Head	1 million Operations
Operating Positions	All Positions	
Operating Pressure –	15 to 115 PSIG (1 to 8 bar)	
Ports	5/32" Instant for Semi-Rigid Nylon or Polyurethane Tube 10-32 UNF Available	
Operating Temperature –	Operating	32°F to 122°F (0°C to 50°C)
	Storage	-22°F to 140°F (-30°C to 60°C)

Most popular.



For inventory, lead times, and kit lookup, visit www.pdnplu.com

Directair 2
& 4 Series

Viking Xtreme
Lever Series

42 Lever/
Pedal Series

M0 Series

Safety



Manual / Mechanical
Valves

Brass Poppet /
Sliding Seal

Control Panel
Products

Sensing

Directair 2 & 4 Series
Viking Xtreme Lever Series
42 Lever / Pedal Series
MO Series
Safety

Manual / Mechanical Valves
Brass Poppet / Sliding Seal
Control Panel Products
Sensing

Modular Pneumatic / Electric Push Buttons

As with electrical contact switches, pneumatic valve modules can be mounted on a number of different operating heads.

- Pneumatic normally non passing (NNP) is equivalent to electrical normally open (N.O.).
- Pneumatic normally passing (NP) is equivalent to electrical normally closed (N.C.).

Note: Electrical switches can be stacked, but the rear connection on pneumatic switches prevents stacking. Therefore, when mixing electrical and pneumatic switch bodies on the same operator, the pneumatic switch must be mounted last.



PXBB3911

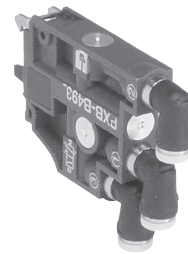

PXBB4932

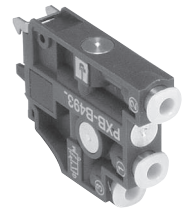

PXBB4931

Push Buttons

Spring Return or Latching
 Mushroom Headed Push Buttons



Standard
 Push Button

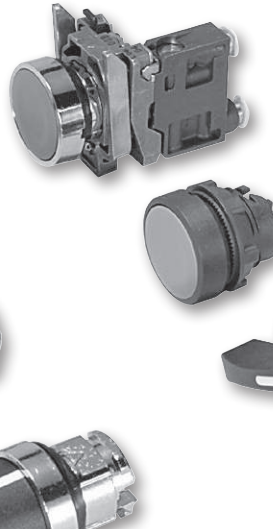

Visual indicators



Selector Switches

2 or 3 Positions,
 Fixed or
 ReturnTo Center



For inventory, lead times, and kit lookup, visit www.pdnplu.com

Functionality Explanation

Fluid Power			Universal Description	Electrical	
Function	Symbol			Function	Symbol
Normally Closed (N.C.)	2-Way		Normally Non-Passing (NNP)	Normally Open (N.O.)	
	3-Way				
Normally Open (N.O.)	2-Way		Normally Passing (NP)	Normally Closed (N.C.)	
	3-Way				

Type of Switching: Universal 3-Way: Valve can be connected either as NP or NNP as required by connecting the primary air supply to port 1 or port 3.

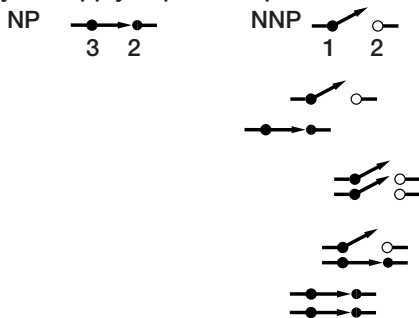

Combination of Output Devices On a Single Mounting Block

Up to 3 output devices (valves or electrical contacts) can be mounted side by side on 1 mounting block.

Note: The central position can only be activated by push button heads.

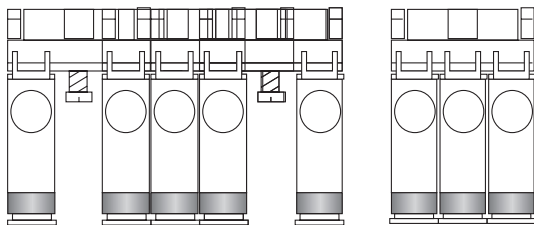

Electrical Contacts and Valves can be Combined Either Side by Side, or by Mounting the Valve on the Back of the Electrical Contact.

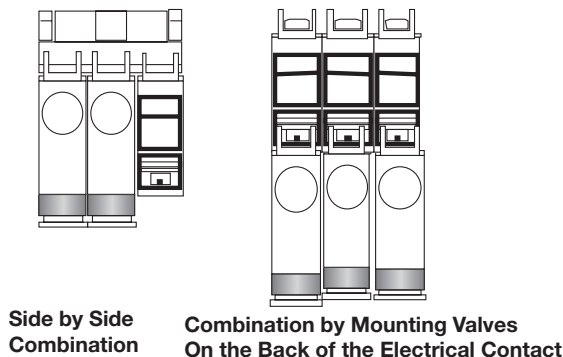

Assembling Output Devices and Heads On ZB5 Series Mounting Block

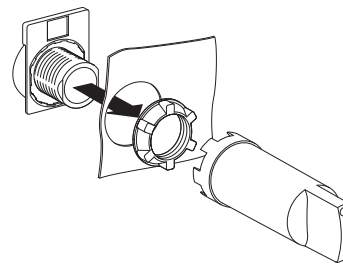

Replacement Old Style Mounting

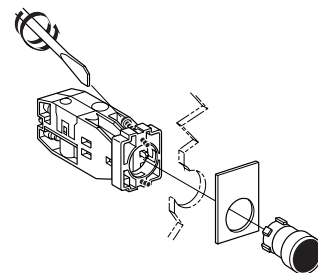

Directair 2 & 4 Series
Viking Xtreme Lever Series
42 Lever / Pedal Series
M0 Series
Safety
M
Manual / Mechanical Valves
Brass Poppet / Sliding Seal
Control Panel Products
Sensing

Dimensional Data

PXB-B3 Dimensions

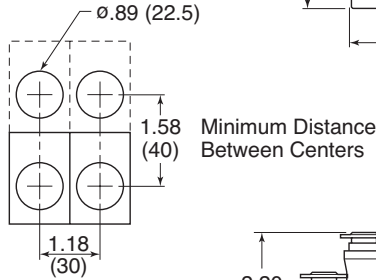
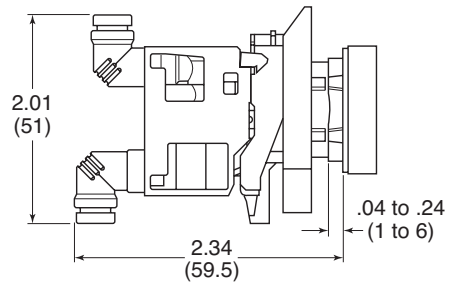
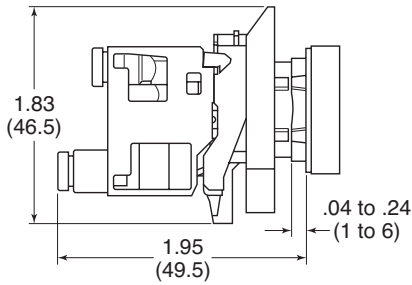

PXB-B4 Dimensions

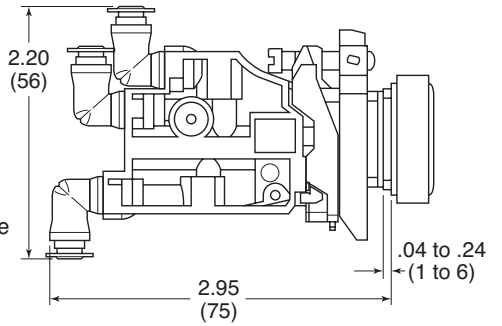
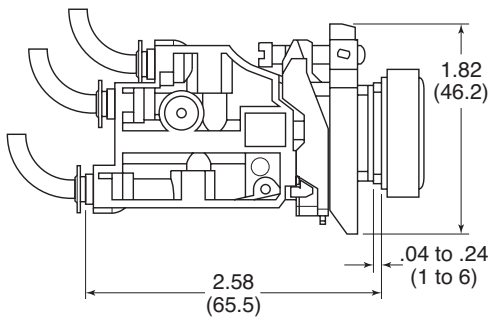

Tube Bending Radius For PXBB3 and PXBB4

- 4 mm O.D. x 2 mm I.D. Tube = Minimum 0.39 (10) Radius
- 4 mm O.D. x 2.7 mm I.D. Tube = Minimum 0.59 (15) Radius

Assembly

Assembling PXB Valves On Mounting Block

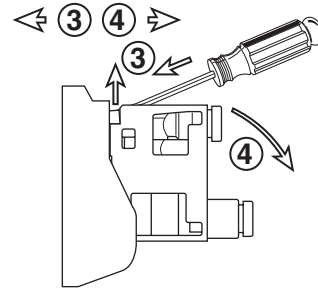
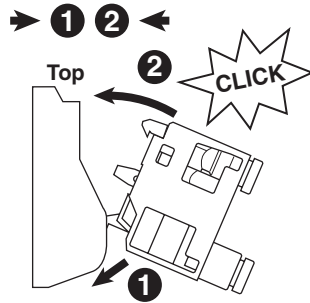

Assembling PXB Valves On the Back of the Electrical Contact

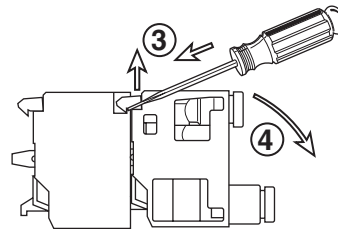
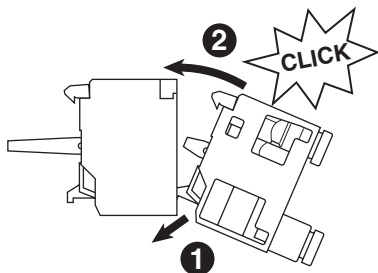

For inventory, lead times, and kit lookup, visit www.pdnplu.com

Directair 2 & 4 Series	Viking Xtreme Lever Series	42 Lever / Pedal Series	MO Series	Safety	Manual / Mechanical Valves	Brass Poppet / Sliding Seal	Control Panel Products	Sensing
------------------------	----------------------------	-------------------------	-----------	--------	----------------------------	-----------------------------	------------------------	---------

Features

Limit Switches

To achieve the sensing or feedback function, pneumatic sensors can be:

- Limit switches in a variety of sizes and configurations
- Pressure switches with many adjustable ranges
- Components designed specifically for pneumatic technology using pressure variation, air bleed or blocking for detection.

A wide variety of pneumatic sensors are available to suit any application requirement.

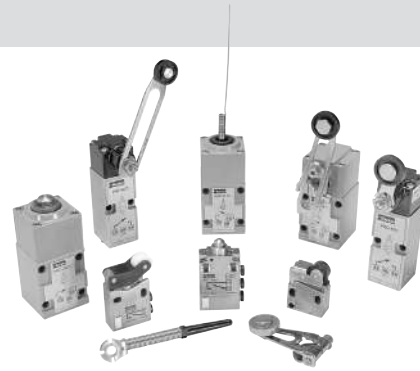



Material specifications

Body	Zinc alloy
Poppets	Polyurethane
Seals	Nitrile (Buna N)

Operating information

Operating pressure:	40 to 115 PSIG (3 to 8 bar)
Operating temperature:	32°F to 122°F (0°C to 50°C)
Storage	-22°F to 140°F (-30°C to 60°C)

3/2 Miniature Direct Acting Limit Switches
1/16" I.D. Internal Orifice

	Actuator	Type of switching*	Flow SCFM (NI/min)	Nominal Bore	Connection	Part Number
	Steel Plunger Operating Levers Available	NNP	2.2 (60)	1/16" (1.5mm)	5/32" instant	PXCM111
					10-32 UNF	PXCM115
	Plastic Roller	NNP	3.0 (85)		5/32" Instant	PXCM121
					10-32 UNF	PXCM125

7/64" I.D. Internal Orifice

	Plastic Roller	NNP	8.8 (250)	7/16" (2.5mm)	5/32" Instant	PXCM521
---	----------------	-----	-----------	---------------	---------------	----------------

Actuators For Steel Plunger (Use with PXCM11*)

	Plastic Roller Lever					PXCZ11
---	----------------------	--	--	--	--	---------------

* NNP: Normally non-passing. 

Specifications

Air Quality – Standard Shop Air, Lubricated or Dry	40 µm Filtration
Maximum Operating Frequency	5 Hz
Number of Operations with Dry Air at 90 PSI (6 bar) and 68°F (20°C) - Frequency 1 Hz	10 million
Operating Positions	All Positions

 Most popular.



For inventory, lead times, and kit lookup, visit www.pdnplu.com

E75

Parker Hannifin Corporation
Pneumatic Division
Richland, Michigan
www.parker.com/pneumatics

Directair 2 & 4 Series

Viking Xtreme Lever Series

42 Lever / Pedal Series

M0 Series

Safety



Manual / Mechanical Valves

Brass Poppet / Sliding Seal

Control Panel Products

Sensing

Part Numbers



Sensing

Directair 2
& 4 Series

3/2 Compact Pilot Operated Limit Switches
7/64" I.D. Internal Orifice, 5/32" Instant Connections, Pipeable Exhaust Port

Viking Xtreme
Lever Series

42 Lever /
Pedal Series





Actuator	Type of Switching*	Flow SCFM (NI/min)	Nominal Bore	Connection	Part Number
 Steel Plunger Operating Levers Available					PXCM601A110
 Steel Roller Plunger	NNP	8.8 (250)	7/64" (2.5mm)	5/32" instant	PXCM601A102
 90° Steel Roller Plunger					PXCM601A103

M0 Series

Standard Duty Limit Switches – “K” Series

Safety

Plunger Operated Limit Switches
1/8" I.D. Internal Orifice, 5/32" Instant Connections, Pipeable Exhaust Port

Actuator	Type of Switching*	Flow SCFM (NI/min)	Nominal Bore	Connection	Part Number
 Steel Plunger	NNP	7.4 (210)	1/8" (3mm)	5/32" instant	PXCK21101
	NP				PXCK22101
 Steel Roller Plunger	NNP	7.4 (210)	1/8" (3mm)	5/32" instant	PXCK21102
	NP				PXCK22102
 Plastic Roller Plunger	NNP	7.4 (210)	1/8" (3mm)	5/32" instant	PXCK21121
	NP				PXCK22121
 Cats Whisker	NNP	7.4 (210)	1/8" (3mm)	5/32" instant	PXCK21106
	NP				PXCK22106

Manual / Mechanical
Valves

Brass Poppet /
Sliding Seal

Control Panel
Products

* NNP: Normally non-passing. 

 Most popular.





For inventory, lead times, and kit lookup, visit www.pdnplu.com

Sensing

Part Numbers

Roller Operated Limit Switches

1/8" I.D. Internal Orifice, 5/32" Instant Connections, Pipeable Exhaust Port

	Actuator	Type of Switching*	Flow SCFM (NI/min)	Nominal Bore	Connection	Part Number
	Fixed Delrin Roller Lever Multi-Function Head Actuates:	NNP	7.4 (210)	1/8" (3mm)	5/32" Instant	PXCK2110031
	- from Right and Left - from Right - from Left	NP				PXCK2210031
	Adjustable Delrin Roller Lever Multi-Function Head Actuates:	NNP	7.4 (210)	1/8" (3mm)	5/32" Instant	PXCK2110041
	- from Right and Left - from Right - from Left	NP				PXCK2210041

Separate Pneumatic Switch Bodies



	Actuator	Type of Switching*	Part Number
	For Use with Zck Series Operating Heads	NNP	PXCK211
		NP	PXCK221

Pneumatic Switch Bodies with Rotary Heads

	Actuator	Type of Switching*	Part Number
	Multi-Function Head Actuates:	NNP	PXCK21100
	- from Right and Left - from Right - from Left	NP	PXCK22100

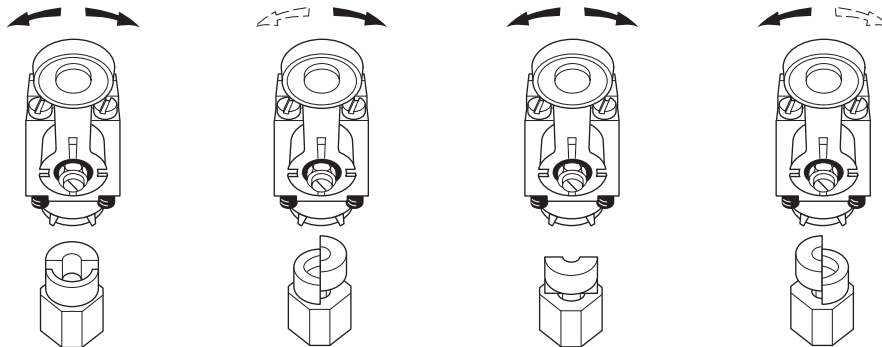
Field Conversion of Rotary Operating Head



* NNP: Normally non-passing. 
NP: Normally passing. 

 Most popular.



For inventory, lead times, and kit lookup, visit www.pdnplu.com

Directair 2 & 4 Series

Viking Xtreme Lever Series

42 Lever / Pedal Series

M0 Series

Safety



Manual / Mechanical Valves

Brass Poppet / Sliding Seal

Control Panel Products

Sensing

Part Numbers

Directair 2
& 4 Series

Viking Xtreme
Lever Series

42 Lever /
Pedal Series

M0 Series

Safety



Manual / Mechanical
Valves

Brass Poppet /
Sliding Seal

Control Panel
Products

Sensing

Standard Duty Limit Switches – “K” Series

Operating Heads

For Use With PXCK Switch Bodies

Actuator	Description	Part Number
Rotary operated		
	Die Cast Zinc	ZCKG00
Plunger operated		
Roller plunger		ZCKD02
Whisker		ZCKD06
Rod plunger	Plunger Operated	ZCKD10
Delrin roller lever on plunger		ZCKD21
Steel roller lever on plunger		ZCKD23

Operating Levers for Rotary Heads

For Use With Rotary Head ZCKG00

Actuator	Description	Part Number
	Steel 1/8" Square	ZCKY51
	Fiberglass 1/8" Dia. Round	ZCKY52
	Plastic Spring Rod Lever	ZCKY81
	Metal Spring Rod Lever	ZCKY91
	Delrin Roller Lever	ZCKY11
	Steel Roller Lever	ZCKY13
	Adjust. Delrin Roller Lever	ZCKY41
	Adjust. Steel Roller Lever	ZCKY43

Heavy Duty Limit Switches – “J” Series

Switch Bodies Only











Type of Switching*	Part Number
NNP	PXCJ117
NP	PXCJ127

Separate Pneumatic Switch Bodies

Direction of Actuator	Type of Switching*	Part Number
Right & Left, Spring Return	NNP	PXCJ11701
Right or left, Spring Return		PXCJ11705
Right & Left, Spring Return	NP	PXCJ12701
Right or Left, Spring Return		PXCJ12705









Operating Levers for Rotary Heads



Die Cast Zinc. For Use With PXCJ Switch Bodies

Operator	Description	Part Number
	Delrin Roller	ZC2JY11
	Steel Roller	ZC2JY13
	Offset Delrin Roller	ZC2JY21
	Plastic Spring Rod	ZC2JY81
	Metal Spring Rod	ZC2JY91
	Delrin Roller	ZC2JY31
	Offset Delrin Roller	ZC2JY41
	Single Track, Delrin Roller	ZC2JY71
	Fork Lever	ZC2JY61
	Double Track, Delrin Rollers	ZC2JY61

Top Plunger & Rotary Operating Heads

Die Cast Zinc. For Use With PXCJ Switch Bodies

Operation	Description	Part Number
Top Plunger Type		
	Top Push	ZC2JE61
	Top Roller Push	ZC2JE62
	Side Push	ZC2JE63
	Cat's Whisker	ZC2JE70
Rotary Type		
	From Left & Right	ZC2JE01
	Counterclockwise from Right	ZC2JE02
	Clockwise from Left	ZC2JE03
	From Left or Right	ZC2JE05
	Maintained Positions	ZC2JE09

* NNP: Normally non-passing. 
NP: Normally passing. 

 Most popular.



For inventory, lead times, and kit lookup, visit www.pdnplu.com

Operator Specifications

	PXCK2••01	PXCK2••02	PXCK2••03	PXCK2••06	PXCK2••00 + Actuator
Differential Angle	—	—	—	12°	3°
Differential Travel	.008" (0.2 mm)	.008" (0.2 mm)	.008" (0.2 mm)	—	—
Maximum Angle of Travel	—	—	—	—	80°
Maximum Travel (B) at 90 PSIG (6 bar)	.228" (5.8 mm)	.228" (5.8 mm)	.228" (5.8 mm)	—	—
Minimum Pre-Travel (A) at 90 PSIG (6 bar)	.087" (2.2 mm)	.087" (2.2 mm)	.102" (2.6 mm)	—	—
Minimum Operating Force at 90 PSI (6 bar)	3.6 lbf (16N)	4.5 lbf (20N)	3.4 lbf (15N)	—	—
Minimum Operating Torque at 90 PSI (6 bar)	—	—	—	17.0 oz in (120mNm)	29.8 oz in (210mNm)
Operating Angle	—	—	—	35°	31° (Minimum lever travel including pre-travel required for operation)

Operating Diagram

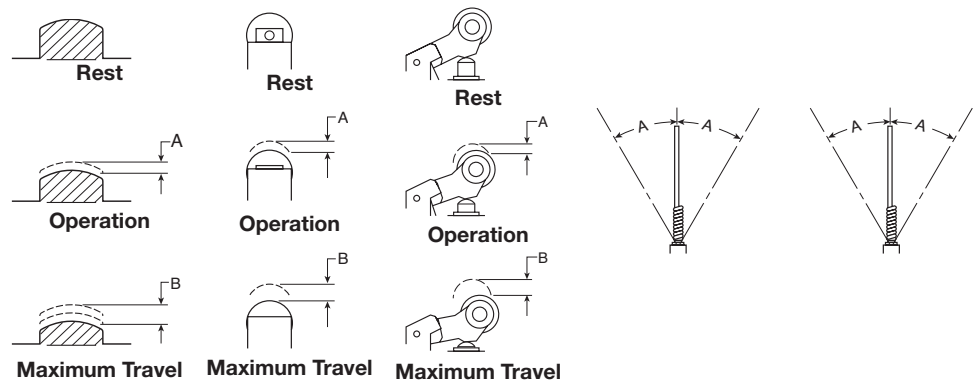

Operators

	PXCM111	PXCM121	PXCM521
Differential Travel at 90 PSI (6 bar)	.006" (0.15 mm)	.012" (0.3 mm)	.020" (0.5 mm)
Maximum Travel (B) at 90 PSIG (6 bar)	.055" (1.4 mm)	.126" (3.2 mm)	.228" (5.8 mm)
Minimum Pre-Travel (A) at 90 PSIG (6 bar)	.035" (0.9 mm)	.079" (2 mm)	.087" (2.2 mm)
Minimum Operating Force at 90 PSI (6 bar)	2.5 lb (11 N)	1.0 lb (4.5 N)	1.6 lb (7 N)

Operating Diagram

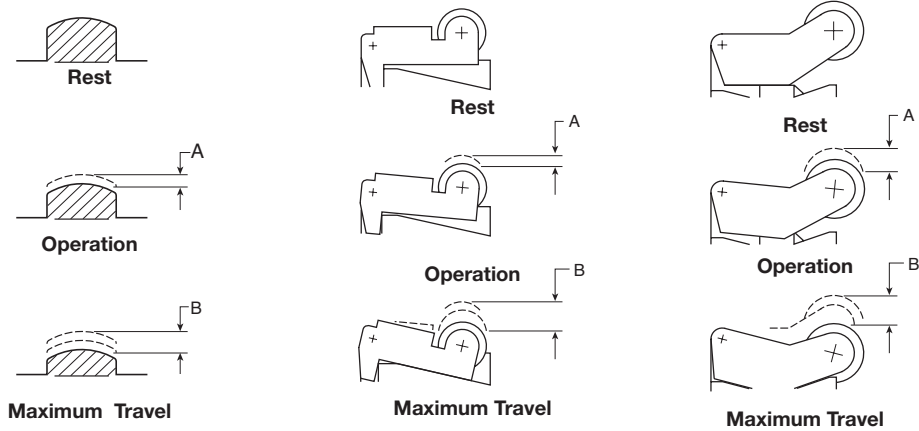

	PXCM601A110	PXCM601A102	PXCM601A103	PXCM601A110 + XCMZ24
Differential Travel at 90 PSI (6 bar)	.012" (0.3 mm)	.008" (0.2 mm)	.020" (0.5 mm)	.047" (1.2 mm) (A)
Maximum Travel (B) at 90 PSIG (6 bar)	.197" (5 mm)	.197" (5 mm)	.197" (5 mm)	—
Minimum Pre-Travel (A) at 90 PSIG (6 bar)	.066" (1.7 mm)	.066" (1.7 mm)	.066" (1.7 mm)	.370" (9.4 mm) (A)
Minimum Operating Force at 90 PSI (6 bar)	5.4 lbf (24 N)	5.2 lbf (23 N)	5.2 lbf (23)	4.3 lbf (19)

Operating Diagram

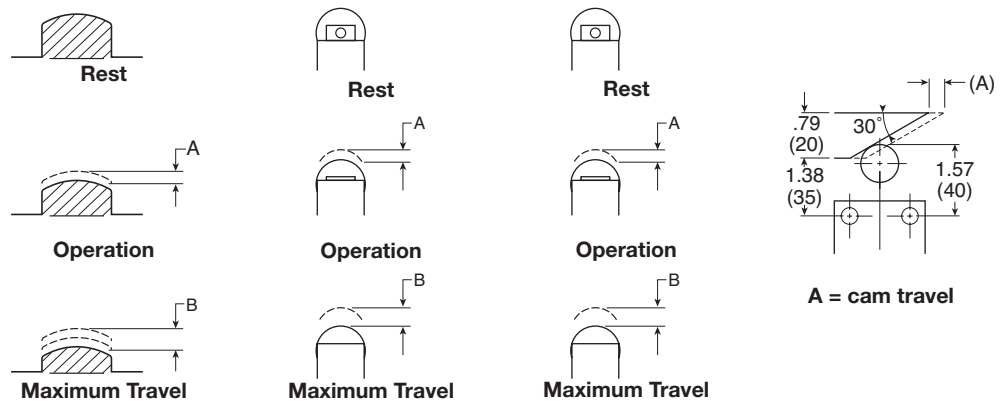

For inventory, lead times, and kit lookup, visit www.pdnplu.com

Directair 2 & 4 Series
 Viking Xtreme Lever Series
 42 Lever / Pedal Series
 MO Series
 Safety
 Manual / Mechanical Valves
 Brass Poppet / Sliding Seal
 Control Panel Products
 Sensing

Miniature Limit Switches

PXCM111

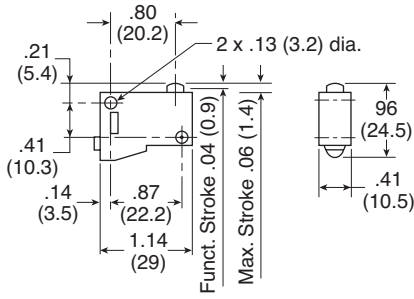

PXCZ12

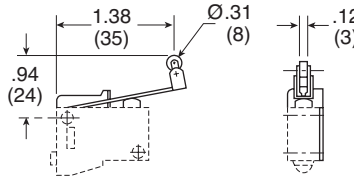

PXCZ11

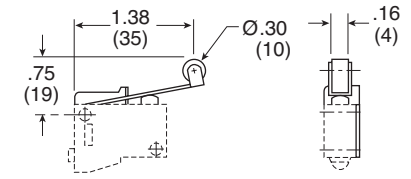

PXCM121, PXCM131

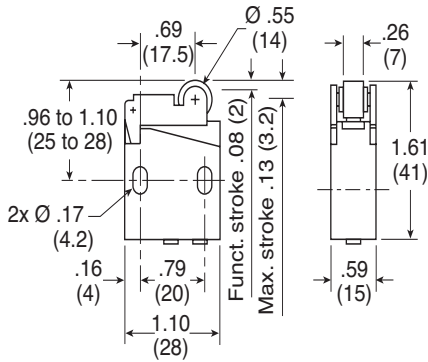

PXCM521

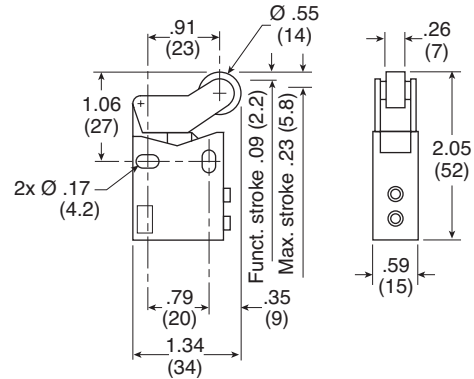

Compact Limit Switches

PXCM601A102

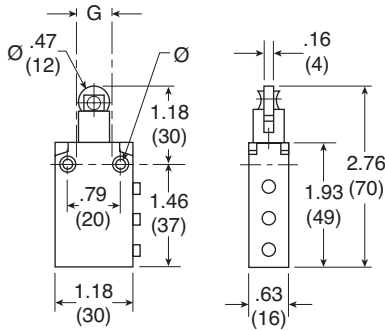

PXCM601A103

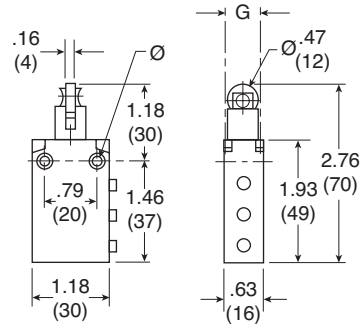

Ø:
 2 mounting holes Ø .17" (4.3)
 2 countersunk Ø .32" (8.2)
 depth 4 mm

PXCM601A110

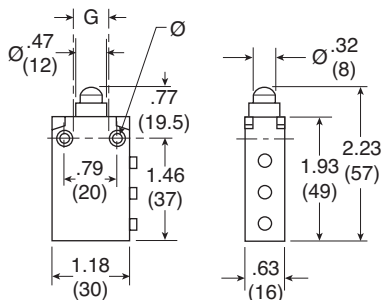

G:
 top mounting holes, 2 x M5
 .71" (18 mm) centers



For inventory, lead times, and kit lookup, visit www.pdnplu.com

Directair 2
 & 4 Series

Viking Xtreme
 Lever Series

42 Lever/
 Pedal Series

M0 Series

Safety



Manual / Mechanical
 Valves

Brass Poppet /
 Sliding Seal

Control Panel
 Products

Sensing

K Series

PXCK21101, PXCK22101

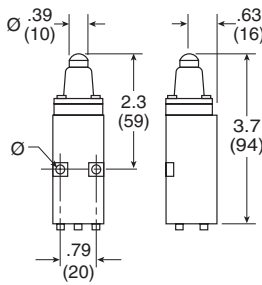

PXCK21102, PXCK22102

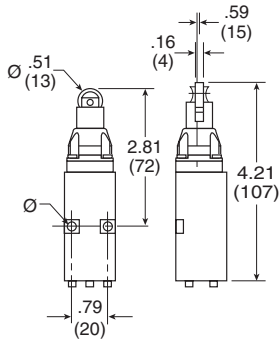

PXCK21121, PXCK22121

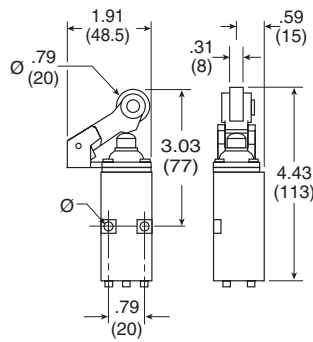

PXCK21106, PXCK22106

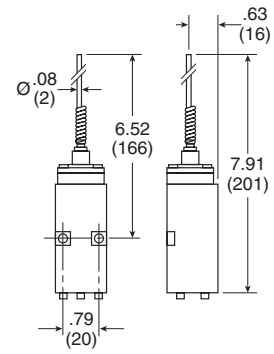

PXCK2110031, PXCK2210031

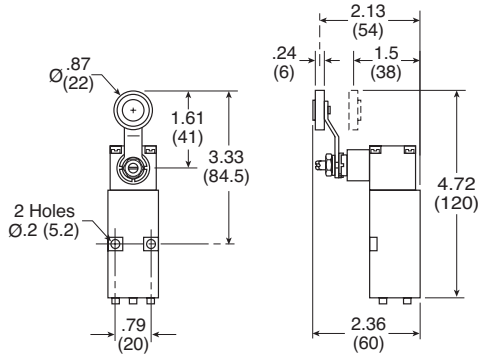

PXCK2110041, PXCK2210041

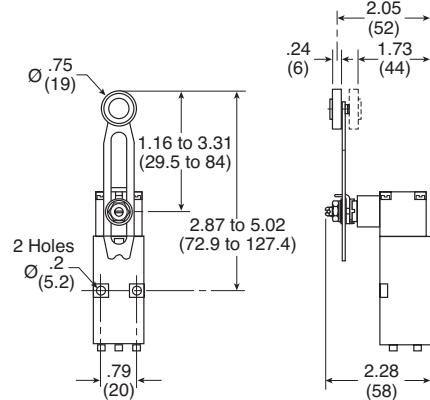

Pneumatic Switch Bodies

PXCK211, PXCK221

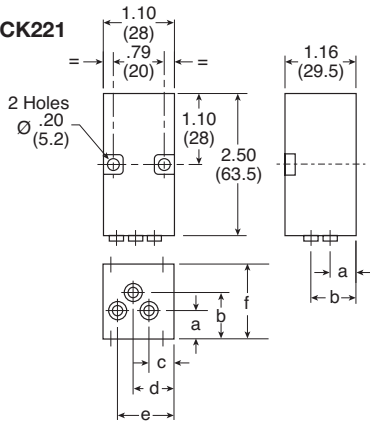

	inch	mm
a	.39	10
b	.77	19.5
c	.35	9
d	.61	15.5
e	.87	22
r	1.66	29.5

Rotary Heads with Operating Levers

ZCKY81

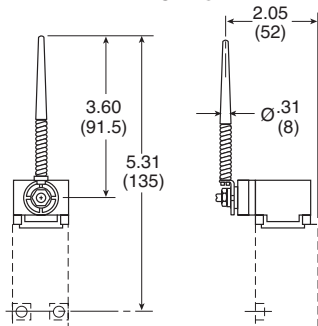

ZCKY91

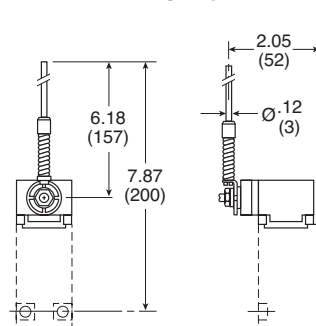

For inventory, lead times, and kit lookup, visit www.pdnplu.com

Directair 2 & 4 Series

Viking Xtreme Lever Series

4:2 Lever / Pedal Series

M0 Series

Safety



Manual / Mechanical Valves

Brass Poppet / Sliding Seal

Control Panel Products

Sensing

J Series

Switch Body With Plunger Heads

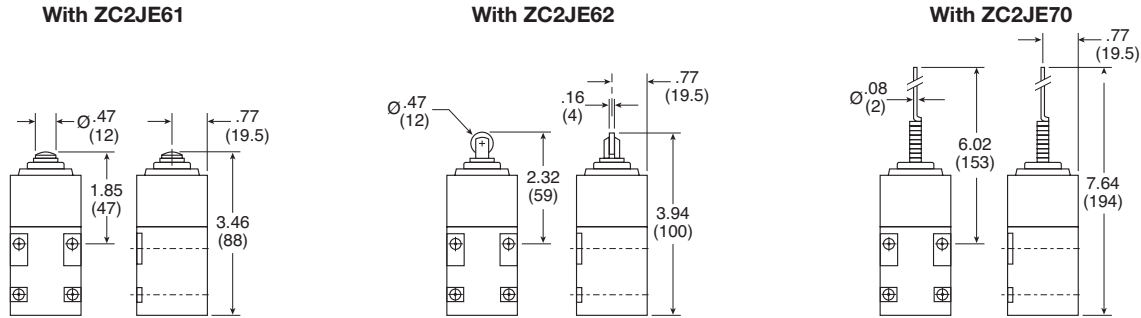

Switch Body With Rotary Heads and Operating Levers

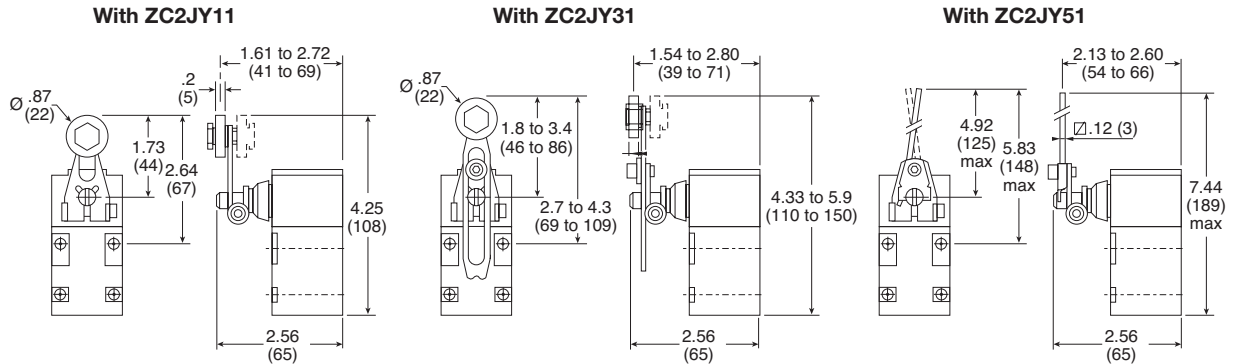

Rotary Heads With Operating Levers

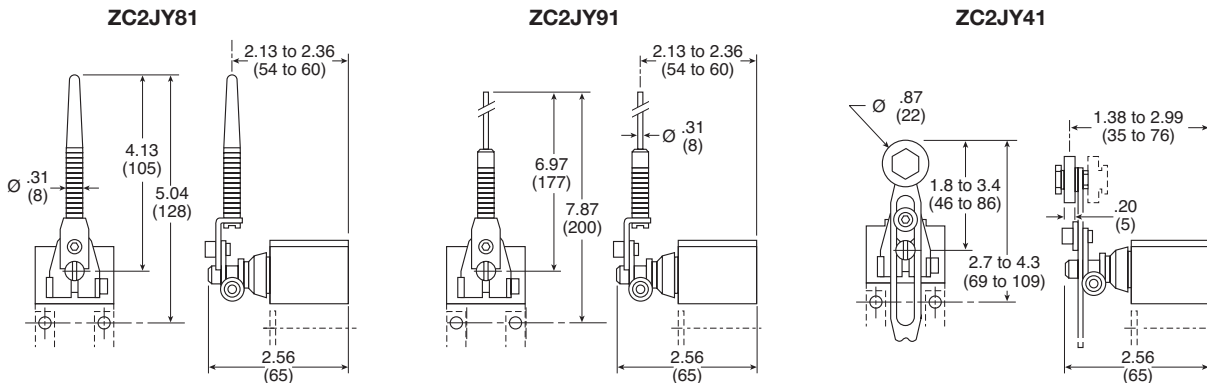

Pneumatic Switch Bodies

PXCJ117, PXCJ127

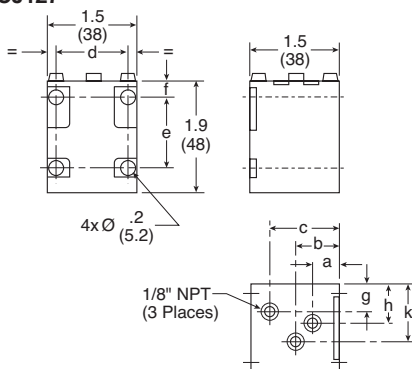

	inch	mm
a	.47	12
b	.75	19
c	1.16	29.5
d	1.14 to 1.18	29 to 30
e	1.18	30
f	.28	7
g	.43	11
h	.51	13
k	.94	24



For inventory, lead times, and kit lookup, visit www.pdnplu.com

Directair 2
& 4 Series

Viking Xtreme
Lever Series

42 Lever/
Pedal Series

M0 Series

Safety



Manual / Mechanical
Valves

Brass Poppet /
Sliding Seal

Control Panel
Products

Sensing

Directair 2 & 4 Series
Viking Xtreme Lever Series
42 Lever / Pedal Series
MO Series
Safety

Manual / Mechanical Valves
Brass Poppet / Sliding Seal
Control Panel Products
Sensing



For inventory, lead times, and kit lookup, visit www.pdnplu.com

Pneumatic Valve Products
Accessories



Flow Controls & Check Valves

337 Micrometer Series	F2
338 Series	F3
3250 Series	F4-F5
3251 Series	F6
339 Series	F7
3047 Series	F7

Miscellaneous Accessories

EM Series Sintered Bronze Muffler / Filters	F8
Muffler / Flow Controls	F8
Breather Vents	F9
Silencers	F9
Stainless Steel Mufflers	F10
Air Line Silencers, Plastic	F11-F12
ECS Reclassifier	F13
Quick Exhaust & Shuttle Valves	F14-F16
Threshold Sensors, PWS Series	F17-F19
Tank Valves	F20
Blow Guns	F21-F22

Integrated Fittings

Index	F23-F24
Compact Flow Control Valves	F25-F26
Miniature Flow Control Valves	F27
Swivel Outlet Flow Control Valves	F28
Plug-In Flow Control Valves	F29
In-Line Flow Control Valves	F30-F31
Compact Metal Flow Control Valves	F32
Flow Control Check Valves	F33-F34
Blocking Flow Control Valves	F35
Threshold Sensors	F36



337 Series Micrometer Flow Control Valves, 1/8" to 3/4" Ports

The "337" Series Flow Control Valves meter flow of air in one direction and allow free flow in the reverse direction.

Valves are manufactured with a fine tapered needle providing precise flow control, even at low flow rates. The perimeter of the adjustment knob features numerical micrometer position markings providing a visual indication of the setting. Once the desired flow is selected, a set screw can be tightened to maintain the setting.

These valves are available with NPTF ports in 1/8", 1/4", 3/8", 1/2", and 3/4" sizes. This series is recommended for pneumatic service.



Material Specifications

Body	Brass
Check Seal	Urethane
Knob	Aluminum
Needle	Stainless steel
Needle Seals	Buna N (Fluorocarbon optional – consult factory)
Retainer	Zinc- Plated Steel
Spring	Stainless Steel
Set Screw	Steel

Operating information

Maximum operating pressure: 250 PSIG
Cracking pressure for return check poppet 1 to 2 PSIG

Operating temperature: *
Standard: 0°F to 180°F
Extended: 0°F to 300°F (consult factory)

* Ambient temperatures below freezing require moisture-free air. Ambient temperatures below freezing and above 180° require lubricants especially selected for suitability at these temperatures. Pneumatic valves should be used with filtered and lubricated air.

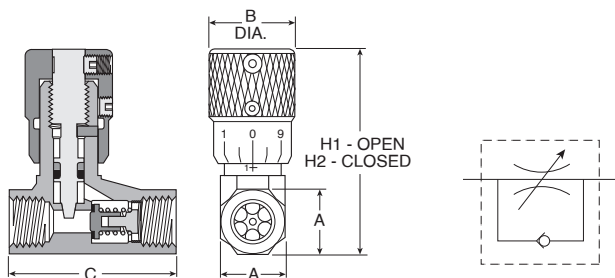

337 Micrometer Flow Control Valves – NPT

Port Size	Flow (SCFM †)		A	B	C	H1	H2	Part Number	Service Kits
	Adj.	Free Flow							
1/8"	15	32	9/16"	0.75	1.47	2.03	1.81	003371000	003378000
1/4"	28	75	11/16"	0.75	1.47	2.28	2.03	003371001	003378001
3/8"	59	139	7/8"	0.88	2.31	2.84	2.53	003371002	003378002
1/2"	126	183	1-3/16"	1.06	3.25	3.62	3.22	003371003	003378003
3/4"	140	327	1-3/8"	1.06	3.25	3.72	3.31	003371004	003378004

337 Micrometer Flow Control Valves – BSPP

Port Size	Flow (SCFM †)		A	B	C	H1	H2	Part Number	Service Kits
	Adj.	Free Flow							
1/8"	15	32	9/16"	0.75	1.47	2.03	1.81	00337G1000	003378000
1/4"	28	75	11/16"	0.75	1.47	2.28	2.03	00337G1001	003378001

† At 100 PSIG inlet pressure with full pressure drop.

Most popular.



For inventory, lead times, and kit lookup, visit www.pdnplu.com

338 Series Flow Control Valves, 1/8" to 3/4" Ports

"338" Series needle valves bi-directionally meter the flow of air through the valve.

This series features a fine tapered needle providing precise flow of air in both directions. Numerical micrometer position markings are stamped on the perimeter of the adjustment knob which provide a visual indication of the setting. Once the desired flow is selected, a set screw can be tightened to maintain the setting.

These valves are available with NPTF ports in 1/8", 1/4", 3/8" 1/2" and 3/4" sizes. This series is recommended for pneumatic service.



Material Specifications

Body	Brass
Internal Components	Stainless steel
Seals	Buna N (Fluorocarbon optional – consult factory)

Operating information

Maximum operating pressure: 250 PSIG

Operating temperature:*

Standard: 0°F to 180°F

Extended: 0°F to 300°F (consult factory)

* Ambient temperatures below freezing require moisture-free air. Ambient temperatures below freezing and above 180° require lubricants especially selected for suitability at these temperatures. Pneumatic valves should be used with filtered and lubricated air.

Flow Controls
& Check Valves

Misc
Accessories

Integrated
Fittings

Accessories

F

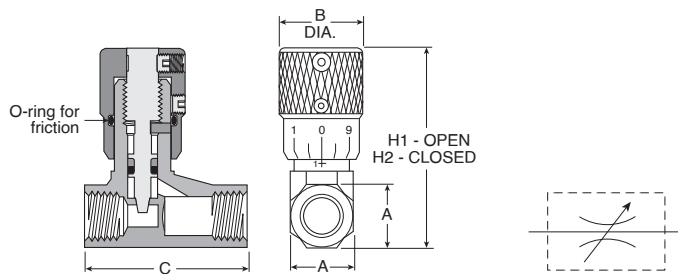

338 Needle Valves – NPT

Port Size	Flow (SCFM †)	A	B	C	H1	H2	Part Number	Service Kits
1/8"	15	9/16"	0.75	1.47	2.03	1.81	003381100	003378000
1/4"	28	11/16"	0.75	1.47	2.28	2.03	003381101	003378001
3/8"	59	7/8"	0.88	2.31	2.84	2.53	003381102	003378002
1/2"	126	1-3/16"	1.06	3.25	3.62	3.22	003381103	003378003
3/4"	140	1-3/8"	1.06	3.25	3.72	3.31	003381104	003378004

338 Needle Valves – BSPP

Port Size	Flow (SCFM †)	A	B	C	H1	H2	Part Number	Service Kits
1/8"	15	9/16"	0.75	1.47	2.03	1.81	00338G1100	003378000
1/4"	28	11/16"	0.75	1.47	2.28	2.03	00338G1101	003378001

† At 100 PSIG inlet pressure with full pressure drop.

Most popular.



For inventory, lead times, and kit lookup, visit www.pdnplu.com

3250 Series Flow Control Valves, 1/8" to 3/4" Ports

The "3250" Series Flow Control Valves are specifically designed to accurately meter the flow of air in one direction and allow free flow in the opposite direction. The "3250" Series Flow Control Valves are also suitable for low pressure hydraulic service.

When air is moving in the free flow direction through the valve, it forces the poppet off its seat and unrestricted air flow is permitted.

When air is moving in the metered direction through the valve, air pressure and the force of the poppet spring causes the poppet to close. Flow must then be through the orifice that is controlled by the metering screw. Opening this screw allows more flow; closing it, less flow.



Operating information

Operating pressure:	250 PSIG (Air) 250 PSIG (Hydraulic)
Operating temperature:	
Standard:	0°F to 180°F
Extended:	0°F to 300°F

Valve will operate mounted in any position. Lock nut on metering screw prevents change in setting during operation.

Material Specifications

Body	Brass
Internal Components	Brass, Stainless steel
Seals	Buna N

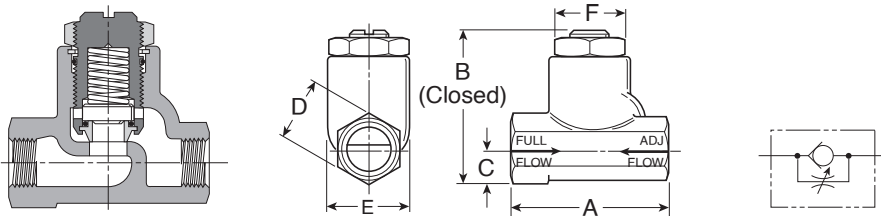

3250 Flow Control Valves, 1/8" to 3/4" Ports – NPT

Port Size	Max. Flow (SCFM)		A	B	C	D	E	F	Part Number
	Metered Direction	Free Flow Direction							
1/8"	70	60	1.75	1.56	0.37	0.62	0.81	0.68	032500119
1/4"	130	120	2.33	1.97	0.44	0.75	1.09	0.94	032500219
3/8"	220	205	2.66	2.44	0.56	1.00	1.38	1.19	032500319
1/2"	295	346	3.11	3.06	0.75	1.25	1.63	1.38	032500419
3/4"	420	615	3.56	3.69	0.88	1.50	2.00	1.75	032500519

3250 Flow Control Valves, 1/8" to 3/4" Ports – BSPP

Port Size	Max. flow (SCFM)		A	B	C	D	E	F	Part Number
	Metered Direction	Free Flow Direction							
1/8"	70	60	1.75	1.56	0.37	0.62	0.81	0.68	3250G0119
1/4"	130	120	2.33	1.97	0.44	0.75	1.09	0.94	3250G0219
3/8"	220	205	2.66	2.44	0.56	1.00	1.38	1.19	3250G0319
1/2"	295	346	3.11	3.06	0.75	1.25	1.63	1.38	3250G0419
3/4"	420	615	3.56	3.69	0.88	1.50	2.00	1.75	3250G0519

Most popular.



For inventory, lead times, and kit lookup, visit www.pdnplu.com

3250 Series Needle Valves, 1" to 1-1/2" Ports

These extra large flow control valves have been developed to provide effective flow settings for large diameter cylinders and for other similar air applications. Each valve has a fine screw adjustment allowing precise settings which are secured by a sturdy lock nut.

Large internal port passages coupled with unique soft seal poppet and inline design provide maximum full flow capacity and minimum pressure drop in the free flow direction. Their cone shaped brass metering valve will provide consistent cylinder speed by regulating cylinder exhaust.



Material Specifications

Body	Cast Aluminum
Internal Components	Brass, Aluminum
Seals	Buna N, Urethane
Spring	Stainless Steel

Operating information

Maximum operating pressure:	250 PSIG
Operating temperature:	
Standard:	-40°F to 180°F
Extended:	-40°F to 350°F (consult factory)

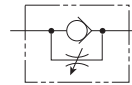
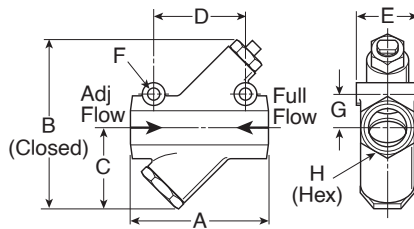
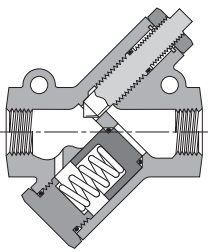

3250 Flow Control Valves, 1" to 1-1/2" Ports – NPT

Port Size	Max. Flow Needle Open		A	B	C	D	E	F	G	H	Part Number
	SCFM†	Cv									
1"	1000	12.3	5.00	6.50	3.00	3.25	2.25	.39	1.31	2.13	032501000
1-1/4"	1200	13.8	5.00	6.50	3.00	3.25	2.25	.39	1.31	2.13	032501250
1-1/2"	1800	17.5	5.88	8.00	3.75	3.50	2.50	.39	1.50	2.38	032501500

3250 Flow Control Valves, 1" to 1-1/2" Ports – BSPP

Port Size	Max. Flow Needle Open		A	B	C	D	E	F	G	H	Part Number
	SCFM†	Cv									
1"	1000	12.3	5.00	6.50	3.00	3.25	2.25	.39	1.31	2.13	03250G1000
1-1/4"	1200	13.8	5.00	6.50	3.00	3.25	2.25	.39	1.31	2.13	03250G1250
1-1/2"	1800	17.5	5.88	8.00	3.75	3.50	2.50	.39	1.50	2.38	03250G1500

† At 100 PSIG inlet pressure with full pressure drop.

 Most popular.



For inventory, lead times, and kit lookup, visit www.pdnplu.com

3251 Series Right Angle Flow Control Valves, 1/8" to 1/2" Ports

The Right Angle Flow Control is an ideal solution to cylinder speed control where space is at a premium. Costly fittings, connections and piping expenses can be eliminated because the valve can rotate 360°, the piping alignment can be in any direction. It then locks into place. The 1/8" model can be rotated after final assembly.

Install by threading male end directly into cylinder port. The free-flow and metered-flow direction is automatically predetermined. Free-flow direction is into cylinder and metered-flow is out of the cylinder. Flow is adjusted with an Allen wrench and locked with nut.

Right Angle Flow Control also available with Prestolok fittings on inlet port to accommodate 5/32 - 3/8 tube sizes. This allows for quick connection and eliminates need for separate tube fitting.

Material Specifications

Body	Brass
Plunger	Brass and Acetal
Seals	Buna N



Shown with Threaded Inlet



Shown with Prestolok Inlet Fitting

Operating information

Operating pressure:	125 PSIG (863 kPa) max.
Operating temperature:	0°F to 140°F (-18°C to 60°C)

Flow Controls
& Check Valves

Misc
Accessories

Integrated
Fittings

Accessories

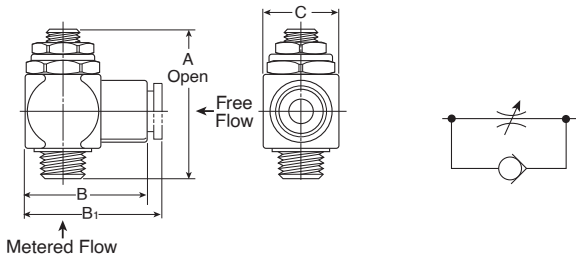

3251 Flow Control Valves – NPT

Thread (NPT) Male	Thread (NPT) Female	Cv		A mm	B mm	C mm	Weight		Part Number
		Adjusted Flow	Free Flow				oz.	kg.	
1/8	1/8	0.26	0.20	44	30	17	2.0	0.9	032510125
1/4	1/4	0.75	0.68	51	36	23	4.5	2.0	032510250
3/8	3/8	0.84	0.72	58	43	27	7.0	3.2	032510375
1/2	1/2	1.64	1.41	68	53	32	11.0	5.0	032510500

With Prestolok Fittings

1/8	5/32	0.19	0.16	44	30	17	2.0	0.9	032511215
1/8	1/4	0.28	0.22	44	30	17	2.0	0.9	032511225
1/4	1/4	0.51	0.44	51	36	23	4.5	2.0	032512525
1/4	3/8	0.62	0.53	51	36	23	4.5	2.0	032512538
3/8	3/8	0.78	0.65	58	43	27	7.0	3.2	032513838

CAUTION: If it is possible that the ambient temperature may fall below freezing, the medium must be moisture-free to prevent internal damage or unpredictable behavior.

Most popular.



For inventory, lead times, and kit lookup, visit www.pdnplu.com

339 Series Check Valves, 1/8" to 3/4" Ports

"339" Series check valves allow free flow in one direction and provide positive checked flow in the reverse direction. These valves are available with NPTF ports in 1/8", 1/4", 3/8", 1/2" & 3/4" sizes. This series is recommended for pneumatic service.



Material Specifications

Body	Brass
Internal Components	Brass / stainless steel / zinc-plated steel
Seals	Urethane (standard) Fluorocarbon (optional, consult factory)

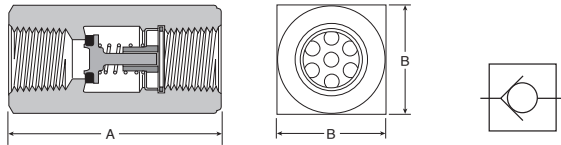

Operating information

Operating pressure: 250 PSIG max.
Cracking pressure 1 to 2 PSIG

Operating temperature: *
Standard: 0°F to 180°F
Extended Option: 0°F to 300°F (consult factory)

* Ambient temperatures below freezing require moisture-free air. Ambient temperatures below freezing and above 180° require lubricants especially selected for suitability at these temperatures. Pneumatic valves should be used with filtered and lubricated air.

339 Check Valve

Port Size	Flow (SCFM †)	A	B	Part Number	
				NPT	BSPP
1/8"	35	1.22	0.56	003393000	00339G3000
1/4"	75	1.34	0.69	003393001	00339G3001
3/8"	143	2.00	0.88	003393002	–
1/2"	162	2.56	1.19	003393003	–
3/4"	323	2.66	1.38	003393004	–

† At 100 PSIG inlet pressure with full pressure drop.

3047 Series Check Valves, 1/4" Ports

"3047" Series check valves allow free flow in one direction and provide positive checked flow in the reverse direction. This valve is available with a male 1/4" NPTF connection and is recommended for pneumatic service.



Material Specifications

Body	Brass
Internal Components	Brass / stainless steel
Seals	Nitrile

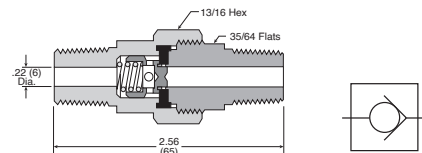

Operating information

Operating pressure: 250 PSIG max.
Cracking pressure 1 to 2 PSIG

Operating temperature: *
Standard: 0°F to 180°F

* Ambient temperatures below freezing require moisture-free air. Ambient temperatures below freezing and above 180° require lubricants especially selected for suitability at these temperatures. Pneumatic valves should be used with filtered and lubricated air.

3047 Check Valve

Port Size	Flow (SCFM †)	Part Number
1/4"	30	030470099

† At 100 PSIG inlet pressure with full pressure drop.

Most popular.



For inventory, lead times, and kit lookup, visit www.pdnplu.com

EM Series – Sintered Bronze Muffler / Filters

Muffler / filters effectively reduce air exhaust noises to an industry accepted level with minimum flow restriction. They protect valves, impact wrenches, screw drivers and other air tools by preventing dirt and other foreign matter from entering the system. Non-corrosive. Can be cleaned with many common solvents.



EM Series

Pipe Thread	Overall Length	Hex Size	Part Number
M5	.75	5/16"	EMM5
1/8"	1.00	7/16"	EM12
1/4"	1.32	9/16"	EM25
3/8"	1.54	11/16"	EM37
1/2"	1.85	7/8"	EM50
3/4"	2.29	1-1/6"	EM75
1"	2.91	1-5/16"	EM100
1-1/4"	3.25	1-11/16"	EM125
1-1/2"	3.69	2"	EM150

Operating information

Operating pressure: 250 PSIG (Air)
Cracking pressure 1 to 2 PSIG

Operating temperature:* 0°F to 300°F

* Ambient temperatures below freezing require moisture-free air. Ambient temperatures below freezing and above 180° require lubricants especially selected for suitability at these temperatures. Pneumatic valves should be used with filtered and lubricated air.

Muffler / Flow Controls

Muffler / flow controls provide an acceptable exhaust noise level and effectively meter exhaust. Installed in valve exhaust ports, they control cylinder piston speeds throughout a wide range. The adjusting screw cannot be accidentally blown out, can be locked to maintain setting. Brass and bronze construction. Clean with commonly used solvents.

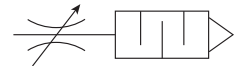

Muffler / Flow Controls

Pipe Thread	Overall Length	Hex Size	Part Number
1/8"	1.15	9/16"	045020002
1/4"	1.42	1/2"	045040004
3/8"	1.49	11/16"	045060060
1/2"	1.77	7/8"	045080080
3/4"	1.98	1-1/16"	045120012
1"	2.15	1-5/16"	045160016

Operating information

Operating pressure: 250 PSIG (Air)
Cracking pressure 1 to 2 PSIG

Operating temperature:* 0°F to 300°F

* Ambient temperatures below freezing require moisture-free air. Ambient temperatures below freezing and above 180° require lubricants especially selected for suitability at these temperatures. Pneumatic valves should be used with filtered and lubricated air.

Most popular.



For inventory, lead times, and kit lookup, visit www.pdnplu.com

Breather Vents

These low silhouette versions of the muffler / filter are useful where space is a problem and / or to prevent contamination. Use for vacuum relief or pressure equalization in gear boxes, oil tanks, reservoirs, etc.



Breather Vent

Pipe Thread	Overall Length	Hex Size	Part Number
1/8"	0.44	7/16"	047020002
1/4"	0.63	9/16"	047040004
3/8"	0.75	11/16"	047060006
1/2"	0.88	7/8"	047080008
3/4"	1.00	1-1/8"	047120012
1"	1.31	1-5/16"	047160016
1-1/4"	1.41	1-11/16"	047200020
1-1/2"	1.50	2"	047240024

NOTE: Breather vents should not be used as exhaust mufflers.

Operating information

Operating pressure: 150 PSIG (Air) max.

Operating temperature:* 0°F to 300°F

Material:

Breather vent: Sintered bronze,
Housing: Zinc plated steel

* Ambient temperatures below freezing require moisture-free air. Ambient temperatures below freezing and above 180° require lubricants especially selected for suitability at these temperatures. Pneumatic valves should be used with filtered and lubricated air.

Flow Controls
& Check Valves

Misc
Accessories

Integrated
Fittings

Accessories

F

ES Series – Silencer

The silencer is designed to give superior performance in noise control with a minimum effect on air efficiency. "Trimline" design allows location in the tightest places without extra plumbing and fittings. Fits directly into the exhaust port of more than 90% of present commercial valves. Slotted body permits rapid discharge of air without undesirable back pressure. Unique nylon screen element resists dirt buildup or clogging.

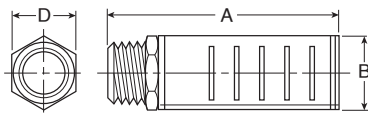

Operating information

Operating pressure: 250 PSIG (Air) max.

Operating temperature:* 0°F to 300°F

* Ambient temperatures below freezing require moisture-free air. Ambient temperatures below freezing and above 180° require lubricants especially selected for suitability at these temperatures. Pneumatic valves should be used with filtered and lubricated air.

ES Series – Silencer

Pipe Thread	Flow SCFM @ 100 PSIG Inlet	Dimensions			Part Numbers	
		A	B	D	NPTF	BSPT (R)
1/8"	115	1.85	0.81	0.63	ES12MC	ESB12MC
1/4"	129	1.85	0.81	0.63	ES25MC	ESB25MC
3/8"	219	3.31	1.26	1.00	ES37MC	ESB37MC
1/2"	549	3.31	1.26	1.00	ES50MC	ESB50MC
3/4"	893	4.56	2.01	1.62	ES75MC	ESB75MC
1"	1,013	4.56	2.01	1.62	ES100MC	ESB100MC
1-1/4"	1,486	5.69	2.88	—	ES125MC	ESB125MC
1-1/2"	1,580	5.69	2.88	—	ES150MC	ESB150MC

Most popular.



For inventory, lead times, and kit lookup, visit www.pdnplu.com

Stainless Steel Mufflers

Corrosion resistant mufflers for harsh environments

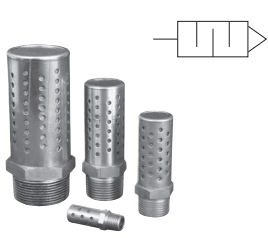

Port Size	Construction	Threads	Dimensions In. (mm)		Part Number
			Width	Length	
1/4	Stainless steel	Male, NPT	0.56 (14.2)	1.75 (44.5)	5500A2004
1/2	Stainless steel	Male, NPT	0.87 (22.1)	2.75 (69.7)	5500A4004
1	Stainless steel	Male, NPT	1.31 (33.3)	3.87 (98.3)	5500A6004
2	Nickel plated	Male, NPT	2.37 (60.2)	5.50 (139.7)	5500A9004*

* Nickel plated

Flow Controls & Check Valves
 Misc Accessories
 Integrated Fittings
 Accessories

ASN Air Line Silencer, Plastic

- Compact
- Lightweight
- Easy to Install
- Excellent Noise Reduction
- Protects Components from Contamination
- NPT and BSPT Threads Available

The plastic silencer is designed to give excellent noise reduction with a minimum effect on air efficiency. The “Trimline” design allows for locating the silencer in the tightest places without extra plumbing or fittings. Fits directly into the exhaust port of most commercial valves. Open surface area of element allows for rapid discharge of air without undesirable back pressure.

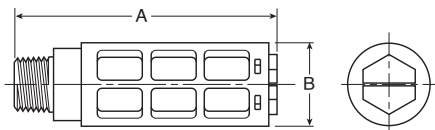

Operating information

Operating pressure:	0 to 150 PSIG (0 to 10 bar, 0 to 1034 kPa)
Operating temperature:	14°F to 140°F (-10°C to 60°C)

Material Specifications

Body	Acetal (Plastic)
Element	Polyethylene

ASN Air Line Silencer, Plastic

Thread Size	A (mm)	B (mm)	Maximum Flow (SCFM) 100 PSIG Inlet	Sound Pressure Level (dBA)		Part Number	
				20 PSIG Inlet	100 PSIG Inlet	NPT	BSPT
M5	0.43 (11)	0.32 (8)	15	69	79	AS-5	
1/8"	1.57 (40)	0.63 (16)	51	69	81	ASN-6	AS-6
1/4"	2.56 (65)	0.83 (21)	124	67	84	ASN-8	AS-8
3/8"	3.35 (85)	0.98 (25)	247	83	98	ASN-10	AS-10
1/2"	3.74 (95)	1.18 (30)	370	69	96	ASN-15	AS-15

Most popular.



For inventory, lead times, and kit lookup, visit www.pdnplu.com

P6M G Thread Air Line Silencer, Plastic

- All Plastic Ultra Light Weight Versions
- High Noise Level Reduction
- Low Back Pressure Generation

The plastic silencer is designed to give excellent noise reduction with a minimum effect on air efficiency. The “Trimline” design allows for locating the silencer in the tightest places without extra plumbing or fittings. Fits directly into the exhaust port of most commercial valves. Open surface area of element allows for rapid discharge of air without undesirable back pressure.

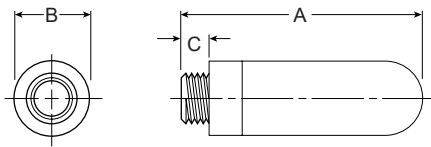
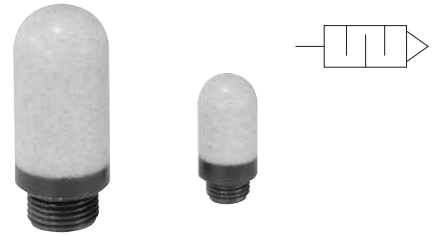

Operating information

Operating pressure:	0 to 246 PSIG (0 to 17 bar, 0 to 1700 kPa)
Operating temperature:	Plastic: 14°F to 176°F (-10°C to 80°C) Metal: 14°F to 165°F (-10°C to 74°C)
Efficiency	92%

P6M G Thread, Air Line Silencer, Plastic

Port Thread	A	Diameter B	C	Weight (grams)	Part Number
M5	0.91 (23)	0.26 (6,5)	0.16 (4)	0.01	P6M-PAC5
G1/8	1.14 (29)	0.55 (14)	0.24 (6)	0.02	P6M-PAB1
G1/4	1.34 (34)	0.67 (17)	0.24 (6)	0.04	P6M-PAB2
G3/8	2.36 (60)	0.98 (25)	0.35 (9)	0.06	P6M-PAB3
G1/2	2.52 (64)	0.98 (25)	0.43 (11)	0.10	P6M-PAB4
G3/4	5.51 (140)	1.50 (38)	0.55 (14)	0.50	P6M-PAB6
G1	6.30 (160)	1.89 (48)	0.79 (20)	0.62	P6M-PAB8

Most popular.



For inventory, lead times, and kit lookup, visit www.pdnplu.com

Flow Controls & Check Valves
 Misc Accessories
 Integrated Fittings
 Accessories



ECS Reclassifier, Air Line Muffler

The ECS (Muffler-Reclassifier) eliminates unwanted oil mist and reduces exhaust noise from pneumatic valves, cylinders and air motors.

- 99.97% Oil Removal Efficiencies
- 25 dBA Noise Attenuation
- 1/2" NPT and 1" NPT
- Disposable Units
- Continuous or Plugged Drain Option
- Metal Retained Construction
- Fast Exhaust Time

Improve Overall Plant Environment

Exhaust oil mist and noise pollution have a direct impact on worker productivity.

Oil aerosol mist from lubricators and compressors is pervasive and enters the industrial plant environment through the exhaust ports of valves, cylinders and air motors. This rapidly expanding exhaust also produces sudden and excessive noise.

The ECS (Muffler-Reclassifier) is 99.97% efficient at removing the oil aerosols. The ECS also acts as a silencer to lower the dBA levels below O.S.H.A. requirements.

The result is a cleaner, quieter environment which equates to greater work productivity and safety.

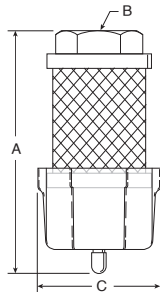

ECS Reclassifier, Air Line Muffler

Thread Size	A	B	C	Part Number
1/2	5.30 (135 mm)	1/2" NPT	2.57 (65 mm)	ECS3
1	7.30 (185mm)	1" NPT	2.57 (65mm)	ECS5

Performance Characteristics

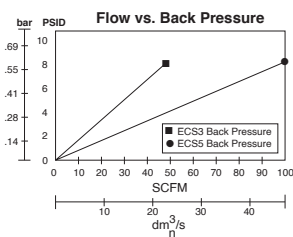
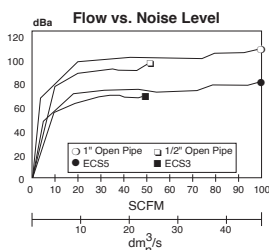

 Most popular.



Operating information

Maximum line pressure:	100 PSIG (6.8 bar)
Maximum operating temperature:	125°F (52°C)

Operation

Compressor oils and lubricating oils are exhausted from valves, cylinders and air motors into the ECS. Oil aerosols are “coalesced” into larger droplets and gravity pulls them into the attached drain sump. The sump can then be drained manually or by using a 1/4" ID plastic tube drain. The air flowing into the ECS is also muffled or silenced as it enters the inside of the ECS and passes through the filter media into the atmosphere.

Proven Technology

The ECS units are constructed from the same materials that go into our oil removal coalescing filter elements.

The seamless design insures media uniformity and strength. This proven technology provides high coalescing efficiency with low pressure drop.

The filter media is supported by cylindrical perforated steel retainers both inside and out. These retainers, fully plated for excellent corrosion resistance, give the ECS units high rupture strength in either flow direction. These filters can also be used as high efficiency inlet or bypass filters for vacuum pumps, or breather elements to protect the air above critical process liquids.

ECS3 / ECS5

The ECS solves two problems inherent in compressed air exhaust from valves, cylinders and air motors - oil mist removal and noise abatement.

The ECS will improve your industrial plant environment, thereby improving worker productivity.

Flow Controls
& Check Valves

Misc
Accessories

Integrated
Fittings

Accessories

F

OR Series Quick Exhaust & Shuttle Valves

Quick exhaust valves provide rapid exhaust of control air when placed between control valve and actuator. They can also be used as shuttle valves. Diaphragm materials are available in urethane, Nitrile, Fluorocarbon, and PTFE to meet a wide variety of operating conditions.

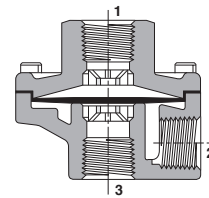

Material Specifications

Body	Die cast aluminum
Static Seals	Nitrile standard with urethane (Others see chart below)
Diaphragm	Standard – Urethane Optional – Fluorocarbon, PTFE, or Nitrile (Depending on size)

Operating information

Operating pressure (Air): 150 PSIG (max), 3 PSIG (min)
200 PSIG (max), 50 PSIG (min) for Model No. OR37TB (PTFE diaphragm)

Operating temperature:*

- Urethane: 0°F to 180°F (-18°C to 80°C)
- Nitrile: 0°F to 180°F (-18°C to 80°C)
- Fluorocarbon: 0°F to 400°F (-18°C to 205°C)
- PTFE: 0°F to 500°F (-18°C to 260°C)

* Ambient temperatures below freezing require moisture-free air. Ambient temperatures below freezing and above 180° require lubricants especially selected for suitability at these temperatures. Pneumatic valves should be used with filtered and lubricated air.

Mounting Bracket Kit – No. 036408100

(Including body screws)

For “OR12” and “OR25” sizes with 7/8” “A” Dimension.

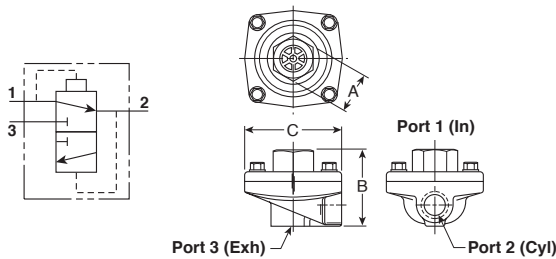
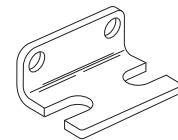

Model Selection, Performance Data and Dimensions

Port 1	Port 2	Port 3	Flow (SCFM †)	Part Number		A	B	C	Service Kit No.
				NPTF	BSPG “G”				
STANDARD Urethane Diaphragms (Nitrile static seals)									
1/4"	1/4"	3/8"	150	OR25NB	ORB25NB	1" Hex	2.06	2.44	033400105
	3/8"	3/8"	240	OR25PB	—	1" Hex	2.06	2.44	033400105
3/8"	3/8"	3/8"	240	OR37B	ORB37B	1" Hex	2.06	2.44	033400105
1/2"	1/2"	1/2"	450	OR50B	ORB50B	1-1/2" Hex	2.88	3.38	034750109
3/4"	3/4"	3/4"	550	OR75B	ORB75B	1-1/2" Hex	2.88	3.38	034750109
Nitrile Diaphragms (Nitrile static seals)									
1/8"	1/8"	1/8"	70	OR12B	ORB12B	7/8" Sq.	1.75	1.88	033400105
	1/8"	1/4"	70	OR12NB	ORB12NB	7/8" Sq.	1.75	1.88	033400105
1/4"	1/4"	1/4"	90	OR25B	ORB25B	7/8" Sq.	1.75	1.88	036408000
	1/4"	3/8"	90	OR25NFB	ORB25NFB	1" Hex	2.06	2.44	033408000
3/8"	3/8"	3/8"	240	OR37FB	ORB37FB	1" Hex	2.06	2.44	033408000
3/4"	3/4"	3/4"	550	OR75FB	ORB75FB	1-1/2" Hex	2.88	3.38	034759000
Fluorocarbon Diaphragms for Extended Temperature Operation (Fluorocarbon static seals)									
1/8"	1/8"	1/8"	70	OR12VB	ORB12VB	7/8" Sq.	1.75	1.88	036508000
	1/8"	1/4"	70	OR12NVB	ORB12NVB	7/8" Sq.	1.75	1.88	036508000
1/4"	1/4"	1/4"	90	OR25VB	ORB25VB	7/8" Sq.	1.75	1.88	036508000
3/8"	3/8"	3/8"	240	OR37VB	ORB37VB	1" Hex	2.06	2.44	033400319
1/2"	1/2"	1/2"	450	OR50VB	ORB50VB	1-1/2" Hex	2.88	3.38	034750120
3/4"	3/4"	3/4"	550	OR75VB	ORB75VB	1-1/2" Hex	2.88	3.38	034750120
PTFE Diaphragms for Higher Pressure and Temperature (Fibre static seals)									
3/8"	3/8"	3/8"	240	OR37TB	ORB37TB	1" Hex	2.06	2.44	033400504

† At 100 PSIG inlet pressure with full pressure drop.

Most popular.



For inventory, lead times, and kit lookup, visit www.pdnplu.com

Shuttle Valves

Shuttle valves determine a single pneumatic output from two separate inputs. If pressure is applied to both ports simultaneously, the valve will select the port with the higher pressure.



Material Specifications

Body	Aluminum
Internal Components	Aluminum
Seals	Nitrile

Operating information

Operating pressure:
 Maximum: 200 PSIG
 Minimum: Differential Pressure 3 PSIG

Operating temperature:* 0°F to 160°F

* Ambient temperatures below freezing require moisture-free air. Ambient temperatures below freezing and above 180° require lubricants especially selected for suitability at these temperatures. Pneumatic valves should be used with filtered and lubricated air.

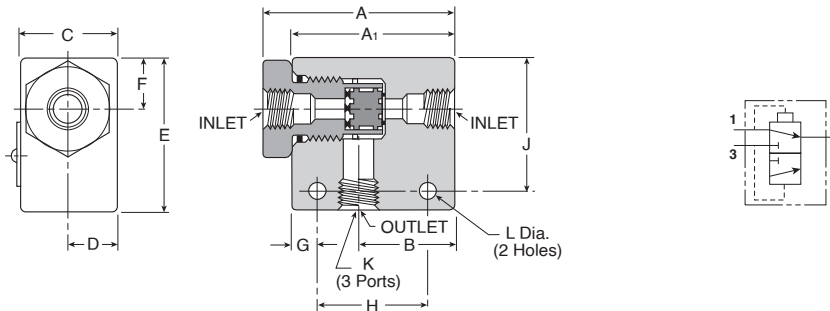

Model Selection and Dimensions

Port Size	Flow (Cv)	Dimensions											Part Number	
		A	A1	B	C	D	E	F	G	H	J	K		L
1/8"	0.32	N/A	1.62	0.81	0.62	0.31	1.00	0.281	0.312	1.00	0.75	1/8 - 27	0.219	N1641001
1/4"	1.65	2.50	2.12	1.25	1.25	0.62	2.00	0.67	0.265	1.25	1.35	1/4 - 18	0.219	N1642003
3/8"	2.02	2.50	2.12	1.25	1.25	0.62	2.00	0.67	0.265	1.25	1.35	3/8 - 16	0.219	N1643003

Most popular.



For inventory, lead times, and kit lookup, visit www.pdnplu.com

Typical “Quick Exhaust Valve” Applications

Flow Controls & Check Valves
Misc Accessories
Integrated Fittings
Accessories

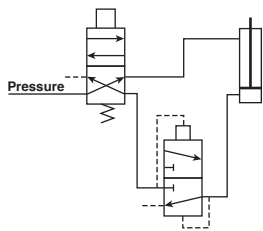

Rapid Retraction – Double Acting Cylinder

In this circuit, air is exhausted through a Quick Exhaust Valve that is **close coupled** to the cap end of the cylinder. Because the Quick Exhaust Valve has a greater exhaust capacity than the four-way Control Valve, increased cylinder speed can be accomplished with a smaller and less expensive control valve.

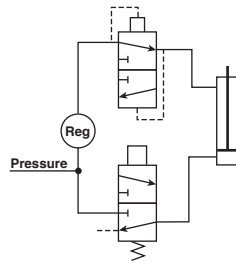

Dual Pressure Actuation of Double Acting Cylinder

This circuit utilizes a Quick Exhaust Valve and a three-way Control Valve to permit rapid extension of the cylinder at a high pressure.

NOTE: Line pressure must be 3 or 4 times greater than rod end pressure. Effective working pressure is the differential between the cap and rod end.

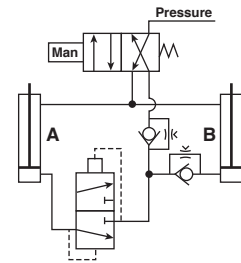

Bi-Directional Control of Two Double Acting Cylinders

This circuit provides maximum control with a minimum of valving. A large four-way Control Valve is not needed to permit the rapid retraction of Cylinder A, as the Quick Exhaust Valve performs this function. The extension of Cylinders A and B and retraction of Cylinder B are controlled by Speed Control Valves.

Typical “Shuttle Valve” Applications

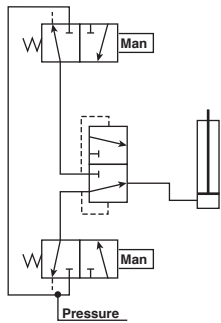

“OR” Circuit

The most common application of the Shuttle Valve is the “OR” Circuit. Here a cylinder or other work device can be actuated by either control valve. The valves can be manually or electrically actuated and located in any position.

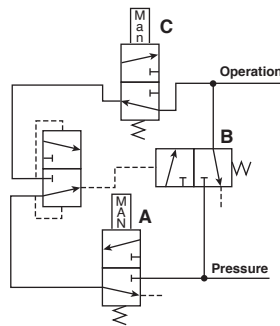

Memory Circuit

This circuit enables continuous operation once initiated. Pressure is delivered to the circuit when Valve A is actuated. This allows pressure to pass through the shuttle valve actuating Valve B. Pressure then flows through Valve B and also the other side of the shuttle valve which holds Valve B open for continuous operation. To unlock the circuit, Valve C must be opened to exhaust the circuit and allow Valve B to return to its normally closed position.

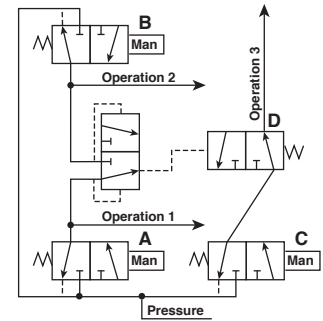

Interlock

This circuit prevents the occurrence of a specific operation while one or another operation takes place. When either Valve A or B is actuated to perform operation 1 or 2, Valve D is shifted to the closed position and prevents operation 3 from occurring.

Threshold Sensors

The plug-in threshold sensors provide feedback information on pneumatic cylinder status in either pneumatic or electrical outputs. Mounted into the cylinder port, these devices monitor the back pressure of the cylinder's exhaust. When the cylinder's piston stops, the back pressure rapidly drops and the threshold sensor provides the desired output. Ideal for variable stroke applications such as robotics where other sensor type devices such as limit switches are impractical, these devices provide a signal whenever the cylinder stops motion.

The threshold sensor consists of two complementary sub assemblies (1) the banjo fitting and (2) the plug-in sensor element. In all cases, the sensor is easily plugged into the banjo fitting and locked in place with a spring clip. The banjo fitting is designed to accept (piggy backed) other functional fittings such as flow controls or blocking valves. Simply select the sensor based on the type feedback signal that best fits the application.

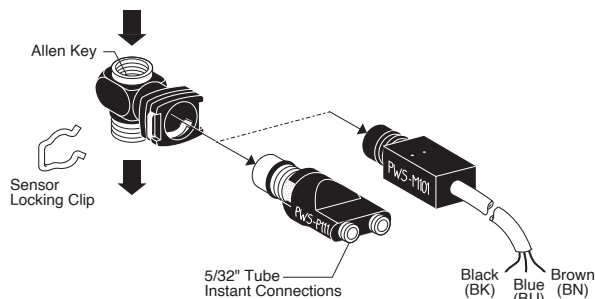

Material specifications

Body	Thermoplastic
Mounting screw	Brass

Banjo Sockets (with Sensor Clip)

Port Size	Wrench	Part Number
10-32	5/16" Hex	PWSB1557
1/8"	3/16" Allen	PWSB1887
1/4"	5/16" Allen	PWSB1997
3/8"	3/8" Allen	PWSB1337
1/2"	1/2" Allen	PWSB1227



Plug-in Sensors

Output	Connection	Part Number
Pneumatic	5/32" push-in	PWSP111
Electrical	3-wire cable (6 ft)	PWSM1012

Most popular.



Operating information

Operating pressure: 0 to 150 PSIG (0 to 10.3 bar)
 Operating temperature:
 Operating 5°F to 140°F (-15°C to 60°C)
 Storage -40°F to 160°F (-40°C to 70°C)

Caution: If it is possible that the ambient temperature may fall below freezing, the medium must be moisture free to prevent internal damage or unpredictable behavior.

Mounting

Banjo fittings in 10-32 to 1/2" pipe sizes are designed to be installed directly into actuator ports (up to 5" bore cylinders). The banjo fitting can accommodate other functional fittings and components such as right angle flow control valves or blocking valves. Banjo fittings screw into actuators using an Allen wrench or 5/16" hex head wrench for 10-32 size. Electrical or pneumatic feedback element snaps into place using a locking clip.

Operation

Pneumatic sensors have a continuous pressure signal applied to the sensor device. Electrical sensors have a continuous electrical signal applied to the sensor device. The threshold sensor assembly mounted directly into the cylinder Port provides an output signal S, which can be pneumatic or electrical, when the falling back pressure in the exhausting chamber of the cylinder reaches the operating threshold (approximately 6-9 PSIG). (The device is a normally passing device. The output is only on when there is nearly zero pressure at the cylinder.)

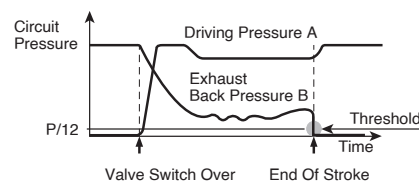

Flow Controls & Check Valves

Misc Accessories

Integrated Fittings

Accessories



Specifications

Maximum Operating Frequency	10 Hz
Pilot Pressure (PWSP111)	>64 PSIG (4.4 bar)
Threshold Pressure	6 to 9 PSIG (.4 to .6 bar)
Output Flow Rate (PWSP111)	3 SCFM at 90 PSIG
Current Rating (PWSM1012) –	5 VA, 250 VAC 5W, 48 VAC
Life Expectancy –	10 million cycles with dry air at 90 PSIG, 68°F, and 1 Hz operating frequency
Voltage Range (PWSM1012) –	12 - 240 VAC 12 - 48 VDC

Air Quality – Standard Shop Air, Lubricated or Dry 40 µm Filtration

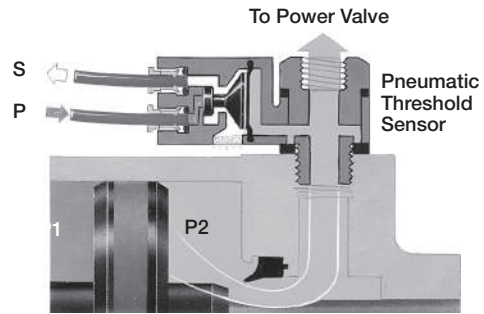
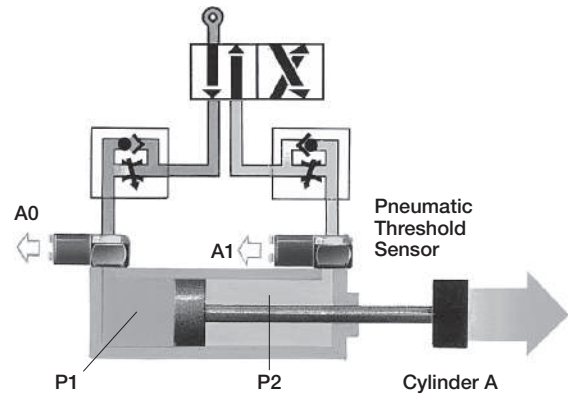
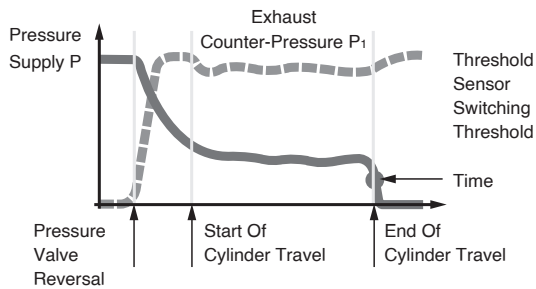

PWS General Characteristics

Permissible Fluids	Air or neutral gas, 50 µm filtration, lubricated or not
Flow	N/A
Mechanical Life	10 Million
Maximum Operating Frequency	10Hz
Maximum Mounting Torque:	
10-32 UNF and M5	88 inch pounds
1/8"	70 inch pounds
1/4"	105 inch pounds
3/8"	265 inch pounds
1/2"	310 inch pounds
Adjustment	N/A
Adjustment Locking	N/A

Piloting and De-Piloting Pressure

Threshold Sensors	Pilot with Operating Pressure of 90 PSI	Depilot with Operating Pressure of 90 PSI
PWSP111	64 PSI	6 PSI
PWSM1012	15 PSI	9 PSI
PWSE101 and PWSE111	10 PSI	7 PSI

Flow Controls
& Check Valves

Misc
Accessories

Integrated
Fittings

Accessories



Fluid Power		Universal Description	Electrical	
Function	Symbol		Function	Symbol
Normally Closed (N.C.)	2-Way	Normally Non-Passing (NNP)	Normally Open (N.O.)	
	3-Way			
Normally Open (N.O.)	2-Way	Normally Passing (NP)	Normally Closed (N.C.)	
	3-Way			



For inventory, lead times, and kit lookup, visit www.pdnplu.com

Blocking Valves

PWBA14/34

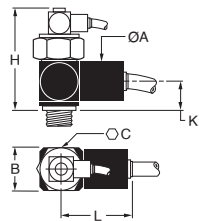

ØA	B	C	K	H	L	Flow*	Part Number
0.86" (22)	0.82" (21)	0.94" (24)	0.53" (13.5)	2.32" (59)	1.54" (39)	14.8	PWBA1468/3468
0.86" (22)	0.82" (21)	0.94" (24)	0.53" (13.5)	2.09" (53)	1.54" (39)	19.4	PWBA1469/3469 PWBA1489
1.06" (27)	1.10" (28)	0.94" (24)	0.55" (14)	2.09" (53)	1.98" (50)	45.9	PWBA1483 PWBA1493/3493
1.22" (31)	1.30" (33)	1.30" (33)	0.94" (24)	2.59" (66)	2.59" (66)	81.2	PWBA1412/3412

PWBA18/38

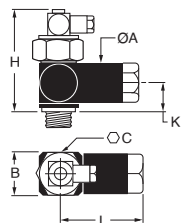

0.86" (22)	0.82" (21)	0.94" (24)	0.53" (13.5)	2.32" (59)	1.71" (43.5)	14.8	PWBA1898/3888
0.86" (22)	0.82" (21)	0.94" (24)	0.53" (13.5)	2.09" (53)	1.71" (43.5)	19.4	PWBA1899/3899
1.06" (27)	1.10" (28)	0.94" (24)	0.55" (14)	2.09" (53)	2.18" (55)	45.9	PWBA1833/3833
1.22" (31)	1.30" (33)	1.30" (33)	0.94" (24)	2.59" (66)	2.47" (63)	81.2	PWBA1822/3822

PWBA38

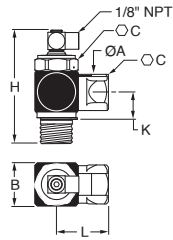

0.75" (19)	0.87" (22)	0.83" (21)	0.67" (17)	2.20" (56)	1.73" (44)	14.8	PWBA38887
0.75" (19)	0.87" (22)	0.83" (21)	0.67" (17)	2.20" (56)	1.73" (44)	19.4	PWBA38997
1.06" (27)	1.18" (30)	1.06" (27)	0.91" (23)	2.64" (67)	1.42" (36)	45.9	PWBA38337
1.06" (27)	1.18" (30)	1.06" (27)	0.91" (23)	2.64" (67)	1.42" (36)	81.2	PWBA38227

Threshold Sensors

Banjo Socket

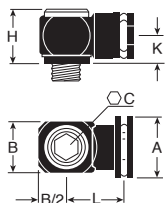

A	B	C	H	K	L	Part Number
.98 (25)	.43 (11)	5/16" Hex	.79 (20)	.40 (10)	.67 (17)	PWSB1557
.98 (25)	.63 (16)	3/16" Allen	.71 (18)	.40 (10)	.79 (20)	PWSB1887
.98 (25)	.83 (21)	5/16" Allen	.71 (18)	.40 (10)	.87 (22)	PWSB1997
.98 (25)	1.10 (28)	3/8" Allen	.79 (20)	.47 (12)	.98 (25)	PWSB1337
.98 (25)	1.30 (33)	1/2" Allen	.93 (24)	.55 (14)	1.02 (26)	PWSB1227

PWSP111

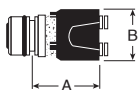

A	B	Part number
.87 (22)	.79 (20)	PWSP111
1.26 (32)	.79 (20)	PWSM1012

PWSM1012



Flow Controls
& Check Valves

Misc
Accessories

Integrated
Fittings

Accessories

F

Tank Valves

For tanks, steel barrels, compressors and other pneumatic containers where a dependable automatic air valve is needed. Equipped with standard valve core and sealing cap. Maximum operating pressure is 185 PSIG. Temperature range is -40°F to 220°F.

091660060, 1/8" pipe thread, dome shaped cap

Has a 1/8" pipe thread at bottom for minimum protrusion. N/P finish, dome shaped cap.

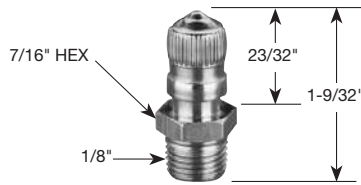

Thread Size	Box Qty	Part Number
1/8	25	091660060

014680006, 1/8" pipe thread part way up the stem, screwdriver type cap

Has a 1/8" pipe thread part way up the stem which allows for minimum protrusion. N/P finish, has screwdriver type cap.

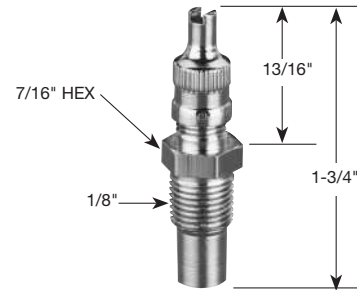

Thread Size	Box Qty	Part Number
1/8	25	014680006

006450060, 1/8" pipe thread at bottom, screwdriver type cap

A 1/8" pipe thread at bottom permits maximum protrusion. N/P finish, screwdriver type cap.

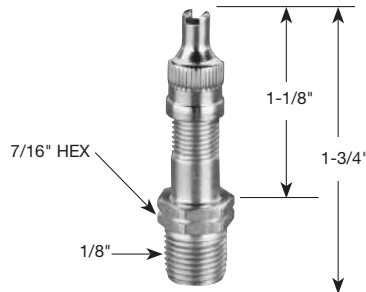

Thread Size	Box Qty	Part Number
1/8	25	006450060

 Most popular.



For inventory, lead times, and kit lookup, visit www.pdnplu.com

Flow Controls & Check Valves
 Misc Accessories
 Integrated Fittings
 Accessories



O.S.H.A. Certification — All safety blow guns conform to the requirements of Compressed Air Standards as currently described in the U.S. Bureau of Labor Standards, paragraph 1910.242, when pressurized at the inlet to a maximum of 100 PSIG. Conform to current O.S.H.A. Directive No. 100-1.

Brass Nozzle Blow Guns

Contoured lever or button control both provide a natural, comfortable grip even when used with gloves. Finger guard and hang-up hook for finger protection and quick safe storage. Die cast zinc body, painted finish.

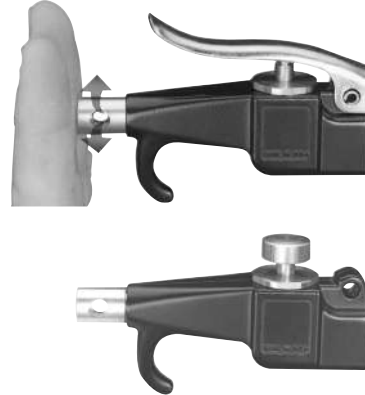

Brass Nozzle Blow Gun

Type	Inlet Port	SCFM Rating*	Part Number
Lever Operated	1/4	20	004750010
Button Operated	1/4	20	004700010

* Based on 100 PSIG inlet pressure.

Flow Controls
& Check Valves

Misc
Accessories

Integrated
Fittings

Accessories



Vortec FLO-GAIN Blow Guns

A quiet Vortec FLO-GAIN nozzle is combined with a high performance blow gun. Compressed air attains sonic velocity through an adjustable slot and attaches to the exterior surface of the cone shaped nozzle. Settings are shown on a micrometer dial. Sound level of 80 dBA with 80 PSIG inlet. Finger guard and hang-up hook offers desirable finger protection and quick secure storage. Die cast zinc body, painted finish.



Vortec FLO-GAIN Blow Gun

Type	Inlet Port	SCFM Rating*	Part Number
Lever Operated	1/4	70+	004750900
Button Operated	1/4	70+	004700900

* Based on 100 PSIG inlet pressure.

Self-Regulating Blow Gun

Designed with integral self-regulating pressure reducing valve for automatic shut-off when nozzle is blocked. Prevents air pressure buildup over 30 PSIG in compliance with U.S. Dept. of Labor standards.

Air shield aids in protecting the operator against blow back of flying chips of dirt. Designed to operate at less than 90 dBA to comply with government regulations. Die cast zinc body, painted finish.



Self-Regulating Blow Gun

Type	Inlet Port	SCFM Rating*	Part Number
Lever Operated	1/4	10	004750010

* Based on 100 PSIG inlet pressure.

 Most popular.

Performance Data

Inlet Pressure	Blocked Pressure	Sound Level
70 PSIG	17.0 PSIG	79 dBA
100 PSIG	21.0 PSIG	83 dBA
175 PSIG	28.0 PSIG	87 dBA



For inventory, lead times, and kit lookup, visit www.pdnplu.com

Brass Nozzle

004707020

General purpose nozzles are supplied as standard on 004700010 and 004750010 blow guns. Conform to the requirements of the Williams Steiger Occupational Safety and Health Act of 1970, paragraph 1910.242 when fitted with blow guns pressurized at the inlet to a maximum of 100 PSIG. Conform to O.S.H.A. Directive 100-1.



	Part Number
Brass Nozzle	004707020

470 and 475 Series Blow Guns

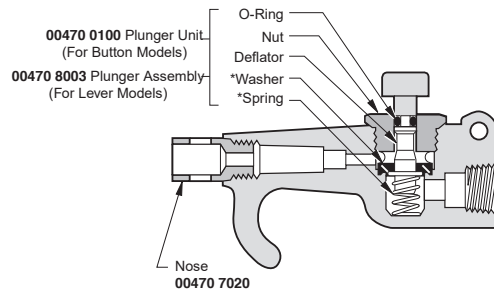

* Contained in Service Kit No. 00470 0090

Flow Controls & Check Valves

Misc Accessories

Integrated Fittings





























Accessories



Most popular.



For inventory, lead times, and kit lookup, visit www.pdnplu.com

Compact Flow Control Valves	FCC731 Meter Out  Page F27	FCC731 Meter Out - BSPP  Page F27	FCCB731 Bi-Directional Flow Control  Page F27	FCCB731 Bi-Directional Flow Control - BSPP  Page F27	FCKC731 Knobless Meter Out Flow Control  Page F28
	FCKC731 Knobless Flow Control - BSPP  Page F28	FCKCB731 Knobless Bi-Directional Flow Control - BSPP  Page F28	Miniature Flow Control Valves	FCM731 Meter Out Flow Control  Page F29	FCM731 Flow Control - BSPP  Page F29
FCMK731 Knobless Mini Meter Out Flow Control  Page F29	Swivel Outlet Flow Control Valves	FCCS731 Compact Swivel Outlet Flow Control  Page F30		FCMS731 Mini Swivel Outlet Flow Control  Page F30	FCMS731 Miniature Swivel Outlet - BSPP  Page F30
Plug-In Flow Control Valves		FCMSP731 Mini Flow Control  Page F31	FCMSP701 Miniature Flow Control  Page F31	FCCSP731 Compact Flow Control  Page F31	
	In-Line Flow Control Valves	FC832 Flow Control  Page F32	FCB832 Bi-Directional Flow Control  Page F32	FCPM832 Panel Mountable Flow Control  Page F33	FC836 Threaded Flow Control  Page F33
Compact Metal Flow Control Valves		FC705 Push-to-Connect Metal Flow Control  Page F34	FC701 Push-to-Connect Metal Flow Control - BSPP  Page F34	FC708 Threaded Port Meter Out Flow Control  Page F34	FC702 Threaded Port Metal Flow Control - BSPP  Page F34
	Flow Control Check Valves	32PLCK In-Line Check Valve  Page F35	W68PLCK Male Check Valve  Page F35	W68PLCKI Male Check Valve Meter In  Page F35	68PLCK Male Check Valve Meter Out - BSPP  Page F36
VC Check Valve  Page F36					









Flow Controls & Check Valves

Misc Accessories

Integrated Fittings

Accessories

F

Blocking Flow Control Valves	FC601 Push-to-Connect Lock Out Valves  Page F37	FC601 Push-to-Connect Lock-Out Valve - BSPP  Page F37	FC602 Threaded Port Lock Out Valves  Page F37	FC608 Threaded Port Lock-Out Valve - BSPP  Page F37	
	Threshold Sensor	PSBJ731 Pneumatic - 5/32 Pilot  Page F38	PSBJ731 Pneumatic - 4mm Pilot  Page F38	PSPJ731 Pneumatic - 10-32 Pilot  Page F38	PSBJ708 Pneumatic - M5 Pilot  Page F38

Flow Controls
& Check Valves

Misc
Accessories

Integrated
Fittings

Accessories



Compact Flow Control Valves

Compact flow control regulators ensure excellent performance of flow and are perfectly suited for reduced spaces due to their small size. The sensitivity of the adjustment screw provides very precise air flow control and regulation. A locking nut guarantees stability of adjustment against vibration tampering of the flow setting.



Material Specifications

Body (depending upon the model)	Glass reinforced nylon 6.6 Brass
Gripping Ring	Stainless Steel
Adjustment Screws	Nickel-plated brass
Locking Nut	Nickel-plated brass
Base	Nickel-plated brass

Applicable Tube

Tube O.D.	1/8, 5/32, 1/4, 3/8
Tube O.D. (mm)	4, 6, 8, 10, 12

Operating information

Pressure range:	15 to 145 PSI
Temperature range:	30°F to 160°F
Working fluid:	Compressed air

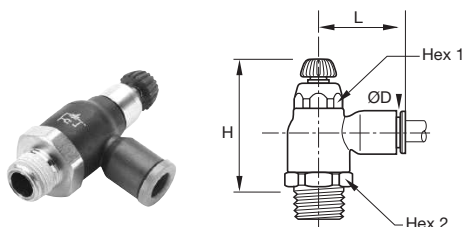

FCC731 Compact Meter Out - NPT

Tube Size (In)	NPT	Hex 1 (In)	Hex 2 (In)	H Open	H Closed	L	Part Number
5/32	1/8	0.63	0.39	1.67	1.44	0.85	FCC731-5/32-2
	1/4	0.63	0.39	1.67	1.44	0.85	FCC731-5/32-4
1/4	1/8	0.63	0.39	1.67	1.44	0.85	FCC731-4-2
	1/4	0.63	0.39	1.67	1.44	0.85	FCC731-4-4
3/8	1/4	0.91	0.67	2.03	1.71	1.22	FCC731-6-4
	3/8	0.91	0.67	2.03	1.71	1.22	FCC731-6-6

FC731 Compact Meter Out - BSPP

Tube Size (mm)	BSPP	Hex 1 (mm)	Hex 2 (mm)	H Open	H Closed	L	Part Number
4	1/8	10	16	38.0	44.0	22.0	FCC731-4M-2G
	1/8	10	16	38.0	44.0	22.0	FCC731-6M-2G
6	1/4	10	16	36.5	42.5	22.0	FCC731-6M-4G
	1/8	14	19	41.5	48.0	28.0	FCC731-8M-2G
8	1/4	14	19	41.5	48.0	28.0	FCC731-8M-4G
	3/8	14	19	41.5	48.0	28.0	FCC731-8M-6G
10	1/4	17	23	45.5	53.5	31.5	FCC731-10M-4G
	3/8	17	23	45.5	54.0	31.5	FCC731-10M-6G
12	3/8	17	23	45.5	54.0	35.0	FCC731-12M-6G
	1/2	17	24	45.5	54.0	35.0	FCC731-12M-8G

Most popular.

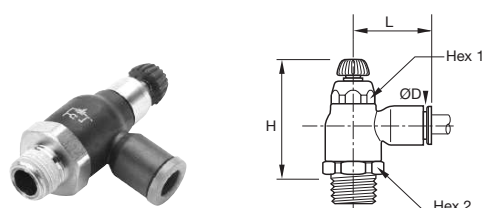

FCCB731 Compact Bi-Directional Flow Control - NPT

Tube Size (In)	NPT	Hex 1 (In)	Hex 2 (In)	H Open	H Closed	L	Part Number
5/32	1/8	0.63	0.39	1.67	1.44	0.85	FCCB731-5/32-2
	1/8	0.63	0.39	1.67	1.44	0.85	FCCB731-4-2
1/4	1/4	0.63	0.39	1.67	1.44	0.85	FCCB731-4-4

FCCB731 Compact Bi-Directional Flow Control - BSPP

Tube Size (mm)	BSPP	Hex 1 (mm)	Hex 2 (mm)	H Open	H Closed	L	Part Number
4	1/8	10	16	38.0	44.0	22.0	FCCB731-4M-2G
	1/8	10	16	38.0	44.0	22.0	FCCB731-6M-2G
6	1/4	10	16	36.5	42.5	22.0	FCCB731-6M-4G
	1/8	14	19	41.5	48.0	28.0	FCCB731-8M-2G
8	1/4	14	19	41.5	48.0	28.0	FCCB731-8M-4G
	3/8	14	19	41.5	48.0	28.0	FCCB731-8M-6G

Flow Controls & Check Valves

Misc Accessories

Integrated Fittings

Accessories

F

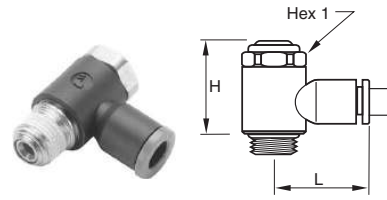
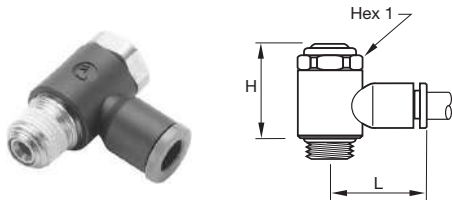

FCKC731 Knobless Meter Out Flow Control - NPT

Tube Size (In)	NPT / UNF	Hex 1 (In)	H	L	Part Number
1/8	10-32	10-32	-	0.69	FCKC731-2-0
	1/8	1/8	13	0.79	FCKC731-2-2
5/32	10-32	10-32	-	0.69	FCKC731-5/32-0
	1/8	1/8	13	0.79	FCKC731-5/32-2
1/4	10-32	10-32	-	0.69	FCKC731-4-0
	1/8	1/8	13	0.79	FCKC731-4-2
5/16	1/4	1/4	17	1.04	FCKC731-4-4
	1/8	1/8	13	0.79	FCKC731-5-2
3/8	1/4	1/4	17	1.04	FCKC731-5-4
	3/8	3/8	20	1.14	FCKC731-6-6

FCKCB731 Knobless Bi-Directional Flow Control - BSPP

Tube Size (In)	BSPP / M5	Hex 1 (In)	H	L	Part Number
4	M5X0.8	8	17.5	17.0	FCKCB731-4M-M5
	1/8	13	25.0	19.0	FCKCB731-4M-2G
6	M5X0.8	8	17.5	19.0	FCKCB731-6M-M5
	1/8	13	25.0	21.0	FCKCB731-6M-2G
8	1/4	17	26.5	22.0	FCKCB731-6M-4G
	1/8	13	25.0	26.0	FCKCB731-8M-2G
8	1/4	17	26.5	27.0	FCKCB731-8M-4G
	3/8	20	37.5	29.0	FCKCB731-8M-6G

FCKC731 Knobless Meter Out Flow Control - BSPP

Tube Size (mm)	BSPP / M5	Hex 1 (mm)	H	L	Part Number
4	M5X0.8	8.0	17.5	17.0	FCKC731-4M-M5
	1/8	13.0	25.0	19.0	FCKC731-4M-2G
6	M5X0.8	8.0	17.5	19.0	FCKC731-6M-M5
	1/8	13.0	25.0	21.0	FCKC731-6M-2G
8	1/4	17.0	26.5	22.0	FCKC731-6M-4G
	1/8	13.0	25.0	26.0	FCKC731-8M-2G
8	1/4	17.0	26.5	27.0	FCKC731-8M-4G
	3/8	20.0	37.5	29.0	FCKC731-8M-6G
10	1/4	17.0	26.5	29.0	FCKC731-10M-4G
	3/8	20.0	37.5	31.0	FCKC731-10M-6G
12	1/2	23.0	43.0	37.0	FCKC731-10M-8G
	3/8	20.0	37.5	6.8	FCKC731-12M-6G
	1/2	23.0	43.0	37.0	FCKC731-12M-8G

Flow Controls
& Check Valves

Misc
Accessories

Integrated
Fittings

Accessories



For inventory, lead times, and kit lookup, visit www.pdnplu.com

Miniature Flow Control Valves

The miniature flow control regulator is especially adapted for all very small sized pneumatic applications (micro-pneumatic in particular). They are specifically designed for use with small bore cylinders (pancake / flat cylinders). Miniature flow control regulators are available in meter out, meter in and Bi-Directional versions.

Material Specifications

Body (depending upon the model)	Glass reinforced nylon 6.6 Brass
Gripping Ring	Stainless Steel
Adjustment Screws	Nickel-plated brass
Locking Nut	Nickel-plated brass
Base	Nickel-plated brass

Applicable Tube

Tube O.D.	1/8, 5/32, 1/4
Tube O.D. (mm)	3, 4, 6, 8

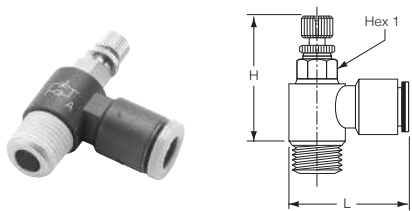

FCM731 Miniature Meter Out Flow Control - NPT

Tube Size (in)	NPT	Hex 1 (mm)	H Open	H Closed	L	Part Number
1/8	10-32	6	1.14	0.91	0.67	FCM731-2-0
	1/8	7	1.41	1.26	0.69	FCM731-2-2
5/32	10-32	6	1.02	0.93	0.67	FCM731-5/32-0
	1/8	7	1.16	1.06	0.71	FCM731-5/32-2
1/4	10-32	6	1.02	0.93	0.73	FCM731-4-0
	1/8	7	1.16	1.06	0.75	FCM731-4-2
	1/4	8	1.28	1.18	0.77	FCM731-4-4

FCM731 Miniature Meter Out Flow Control - BSPP

Tube Size (mm)	BSPP	Hex 1 (mm)	H Closed	H Open	L	Part Number
3	M3X0.5	6	23.5	26.0	17.0	FCM731-3M-M3
	M5X0.8	6	23.5	26.0	17.0	FCM731-3M-M5
4	M3X0.5	6	23.5	26.0	16.5	FCM731-4M-M3
	M5X0.8	6	23.5	26.0	17.0	FCM731-4M-M5
6	1/8	7	27.0	29.5	18.0	FCM731-4M-2G
	M5X0.8	6	23.5	26.0	18.0	FCM731-6M-M5
8	1/8	7	27.0	29.5	18.5	FCM731-6M-2G
	1/4	8	30.0	32.5	19.0	FCM731-6M-4G
8	1/8	13	26.5	31.0	26.0	FCM731-8M-2G
	1/4	16	29.0	34.0	27.5	FCM731-8M-4G
	3/8	20	36.0	42.0	29.0	FCM731-8M-6G

Most popular.



Operating information

Pressure range:	15 to 145 PSI
Temperature range:	30°F to 160°F
Working fluid:	Compressed air

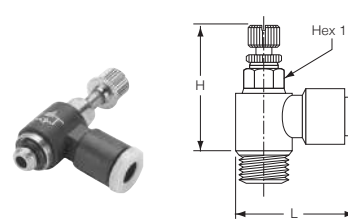

FCMB731 Miniature Bi-Directional Flow Control - BSPP

Tube Size (mm)	BSPP	Hex 1	H Open	H Closed	L	Part Number
4	M5X0.8	6	23.5	26.0	16.5	FCMB731-4M-M5
	1/8	7	27.0	29.5	17.0	FCMB731-4M-2G
6	M5X0.8	6	23.5	26.0	18.0	FCMB731-6M-M5
	1/8	7	27.0	29.5	18.0	FCMB731-6M-2G
6	1/4	8	30.0	32.5	18.5	FCMB731-6M-4G

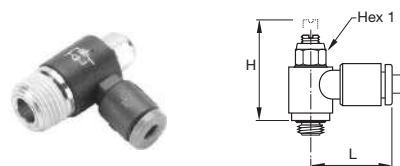

FCMB731 Miniature Bi-Directional Flow Control - BSPP

Tube Size (in)	NPT	Hex 1 mm	H Open	H Closed	L	Part Number
1/8	10-32	6	0.79	0.65	0.65	FCMK731-2-0
	1/8	6	0.85	0.71	0.71	FCMK731-2-2
5/32	10-32	6	0.79	0.65	0.65	FCMK731-5/32-0
	1/8	6	0.85	0.71	0.71	FCMK731-5/32-2
1/4	10-32	6	0.79	0.65	0.65	FCMK731-4-0
	1/8	6	0.85	0.71	0.73	FCMK731-4-2
	1/4	6	0.97	0.83	0.73	FCMK731-4-4



For inventory, lead times, and kit lookup, visit www.pdnplu.com

Flow Controls & Check Valves
Misc Accessories
Integrated Fittings
Accessories



Swivel Outlet Flow Control Valves

Flow control regulators with “swivel outlet” are especially designed to allow a vertical or angled tube exit where access is restricted. The swivel outlet comes with instant push-in connection to ease installation. Flow control regulators with swivel outlet are available in meter out and meter in versions.

Material Specifications

Body	Glass reinforced nylon 6.6
Gripping Ring	Stainless Steel
Adjustment Screws	Nickel-plated brass
Locking Nut	Nickel-plated brass
Base	Nickel-plated brass

Applicable Tube

Tube O.D.	5/32, 1/4, 3/8
Tube O.D. (mm)	4, 6, 8, 10, 12



Operating information

Pressure range:	15 to 145 PSI
Temperature range:	30°F to 160°F
Working fluid:	Compressed air

Flow Controls
& Check Valves

Misc
Accessories

Integrated
Fittings

Accessories

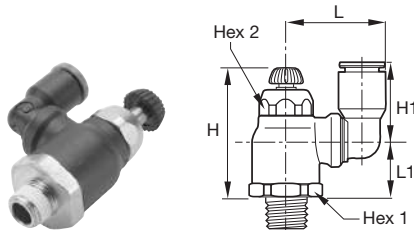

FCCS731 Compact Swivel Outlet Flow Control

Tube Size (In)	NPT	Hex 1 mm	Hex 2 mm	H Closed	H Open	H1	L	L1	Part Number
1/8	1/8	19	10	1.87	2.09	0.63	0.93	0.65	FCCS731-4-2
	1/4	19	14	1.79	1.99	0.73	1.00	0.89	FCCS731-4-4
3/8	1/4	23	17	1.93	2.20	1.04	1.34	0.97	FCCS731-6-4
	3/8	23	17	1.93	2.20	1.04	1.34	0.97	FCCS731-6-6

FCCS731 Compact Swivel Outlet - BSPP

Tube Size (In)	BSPP	Hex 1 mm	Hex 2 mm	H Closed	H Open	H1	L	L1	Part Number
6	1/8	16	10	38.0	44.0	16.0	23.5	18.0	FCCS731-6M-2G
	1/4	16	10	36.5	42.5	16.0	23.5	16.5	FCCS731-6M-4G
8	1/8	19	14	41.5	48.0	23.0	28.0	19.0	FCCS731-8M-2G
	1/4	19	14	41.5	48.0	23.0	28.0	19.5	FCCS731-8M-4G
	3/8	19	14	41.5	48.0	23.0	28.0	17.5	FCCS731-8M-6G
10	1/4	23	17	45.5	53.5	26.5	35.0	21.0	FCCS731-10M-4G
	3/8	23	17	45.5	54.0	26.5	35.0	21.5	FCCS731-10M-6G
	3/8	23	17	45.5	54.0	31.0	38.0	21.5	FCCS731-12M-6G
12	1/2	23	17	45.5	54.0	31.0	38.0	21.0	FCCS731-12M-8G

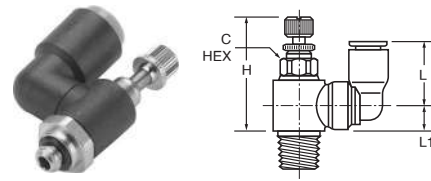

FCMS731 Mini Swivel Outlet Flow Control

Tube Size (In)	NPT	Hex 1 mm	H Closed	H Open	H1	L	L1	Part Number
5/32	10-32	6	0.96	1.08	0.55	0.73	0.26	FCMS731-5/32-0
	1/8	8	1.08	1.20	0.55	0.73	0.33	FCMS731-5/32-2

FCMS731 Miniature Swivel Outlet - BSPP

Tube Size (In)	BSPP	Hex 1 mm	H Closed	H Open	H1	L	L1	Part Number
4	M5X0.8	6	24.5	27.5	14.5	19.5	6.5	FCMS731-4M-M5
	1/8	7	27.5	31.0	14.5	20.0	8.5	FCMS731-4M-2G
6	M5X0.8	6	24.5	27.5	16.0	21.5	6.5	FCMS731-6M-M5
6	1/8	7	27.5	31.0	16.0	22.0	8.5	FCMS731-6M-2G



Plug-In Flow Control Valves

Plug-in flow control regulators can be directly mounted into existing fittings and allow very compact installations. They are particularly suited for mounting in manifolds using cartridges. Their design and function give equal performance to that of flow control regulators with threaded connections.

Material Specifications

Body	Glass reinforced nylon 6.6
Gripping Ring	Stainless Steel
Adjustment Screws	Nickel-plated brass
Locking Nut	Nickel-plated brass
Tailpiece	Nickel-plated brass

Applicable Tube

Tube O.D.	1/8, 5/32, 1/4
Tube O.D. (mm)	4, 6, 8, 10, 12



Operating information

Pressure range:	15 to 145 PSI
Temperature range:	30°F to 160°F
Working fluid:	Compressed air

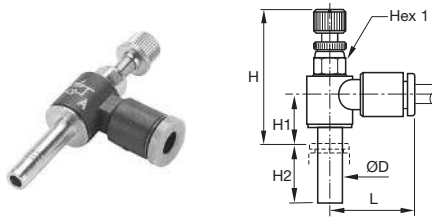

FCMS731 Plug-In Mini Flow Control

Tube Size (In)	Hex 1 mm	H Open	H Closed	H1	H2	L	Part Number
1/8	6	1.04	0.94	0.12	0.59	0.67	FCMS731-2
5/32	6	1.10	1.00	0.37	0.61	0.67	FCMS731-5/32
1/4	7	1.18	1.08	0.12	0.73	0.73	FCMS731-4

FCMS701 - Plug-In Miniature Flow Control

Tube Size (mm)	Hex 1 mm	H Closed	H Open	H1	H2	L	Part Number
4	6	25.5	28.0	9.5	15.5	17.0	FCMS701-4M
6	7	27.5	29.0	10.5	17.0	18.5	FCMS701-6M

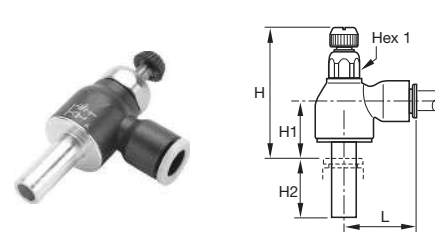

FCCSP731 Plug-In Compact Flow Control

Tube Size (mm)	Hex 1 mm	H Closed	H Open	H1	H2	L	Part Number
6	10	35.0	41.0	14.0	17.0	22.0	FCCSP731-6M
8	14	39.5	46.5	16.0	21.5	28.0	FCCSP731-8M
10	17	43.5	51.5	17.5	24.5	31.5	FCCSP731-10M
12	17	43.0	51.0	17.0	27.0	31.5	FCCSP731-12M

Flow Controls
& Check Valves

Misc
Accessories

Integrated
Fittings

Accessories



In-Line Flow Control Valves

In-line flow controls are unidirectional flow control valves. Intake air flows freely through the flow control; exhaust air is metered out through a specially designed adjustment screw. An arrow on the body of the valve indicates the direction of flow. They can be easily added to existing circuitry. Simply splice it into the cylinder port line.

They can be used individually or they may be stacked together using two joining clips.

Material Specifications

Body	Glass reinforced nylon 6.6
Gripping Ring	Stainless Steel
Adjustment Screws	Nickel-plated brass
Locking Nut	Nickel-plated brass
Tailpiece	Nickel-plated brass

Applicable Tube

Tube O.D.	5/32, 1/4, 5/16, 3/8, 1/2
Tube O.D. (mm)	4, 6, 8, 10, 12



Operating information

Pressure range:	15 to 145 PSI
Temperature range:	30°F to 160°F
Working fluid:	Compressed air

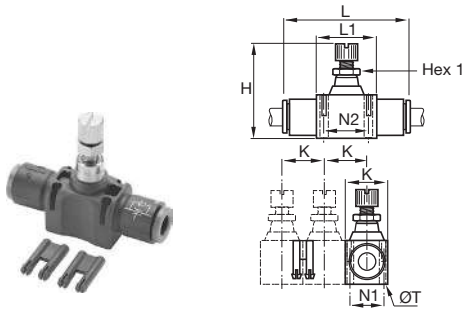

FC832 In-Line Flow Control

Tube Size (In)	Hex 1 mm	H Closed	H Open	K	L	L1	N1	N2	T	Part Number
5/32	5	1.15	1.31	0.47	1.52	0.59	0.31	0.43	0.09	FC832-5/32
1/4	8	1.54	1.74	0.66	2.00	0.90	0.43	0.66	0.12	FC832-4
5/16	11	1.73	1.97	0.73	2.38	1.02	0.49	0.79	0.13	FC832-5
3/8	14	2.03	2.38	0.94	2.87	1.29	0.62	1.01	1.60	FC832-6
1/2	14	2.24	2.63	1.09	3.35	1.37	0.78	1.07	0.16	FC832-8

FC832 In-Line Flow Control

Tube Size (mm)	Hex 1 mm	H Closed	H Open	K	L	L1	N1	N2	T	Part Number
4	5	29.5	33.5	12.0	39.0	15.0	8.0	11.0	2.2	FC832-4M
6	8	39.5	44.5	17.0	54.0	23.0	11.0	17.0	3.2	FC832-6M
8	11	44.0	50.0	18.5	60.5	26.0	12.5	20.0	3.2	FC832-8M
10	14	52.0	61.0	24.0	76.0	33.0	16.0	26.0	4.2	FC832-10M
12	14	57.5	67.5	28.0	86.0	35.0	20.0	27.5	4.2	FC832-12M

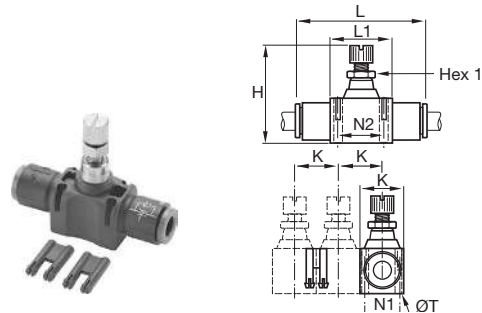

FCB832 In-Line Bi-Directional Flow Control

Tube Size (In)	Hex 1 mm	H Closed	H Open	K	L	L1	N1	N2	T	Part Number
5/32	5	1.15	1.31	0.47	1.52	0.59	0.31	0.43	0.09	FCB832-5/32
1/4	8	1.54	1.74	0.66	2.00	0.90	0.43	0.66	0.12	FCB832-4
5/16	11	1.73	1.97	0.73	2.38	1.02	0.49	0.79	0.13	FCB832-5

FCB832 In-Line Bi-Directional Flow Control

Tube Size (mm)	Hex 1 mm	H Closed	H Open	K	L	L1	N1	N2	T	Part Number
4	5	29.5	33.5	12.0	39.0	15.0	8.0	11.0	2.2	FCB832-4M
6	8	39.5	44.5	17.0	54.0	23.0	11.0	17.0	3.2	FCB832-6M
8	11	44.0	50.0	18.5	60.5	26.0	12.5	20.0	3.2	FCB832-8M

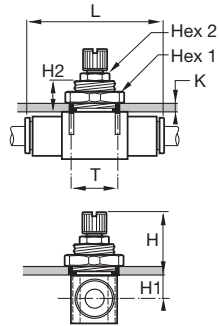

FCPM832 In-Line Panel Mountable Flow Control

Tube Size (mm)	Hex 1 mm	Hex 2 mm	H Closed	H Open	K	L	H1	H2	T	Part Number
4	14		21.5	25.5	6.0	39.0	6.5	11.0	10.5	FCPM832-4M
6	19		27.5	32.5	7.0	54.0	7.5	13.5	16.5	FCPM832-6M
8	24	11	28.5	34.5	7.0	60.5	9.0	13.5	18.5	FCPM832-8M
10	30	14	29.5	38.5	7.0	76.0	11.5	13.5	24.5	FCPM832-10M
12	32	14	32.0	42.0	8.0	86.0	12.5	15.5	27.5	FCPM832-12M

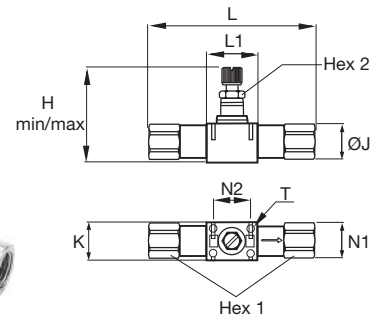

FC836 Threaded In-Line Flow Control

NPT	Hex 1 mm	Hex 2 mm	H Closed	H Open	K	L	L1	N1	N2	T	Part Number
1/8	13	8.00	1.56	1.75	0.67	2.70	0.91	0.43	0.67	0.12	FC836-2
1/4	16	11.00	1.73	1.97	0.73	3.27	1.02	0.49	0.79	0.12	FC836-4
3/8	22	14.00	2.05	2.40	0.94	3.82	1.30	0.63	1.02	0.16	FC836-6
1/2	24	14.00	2.26	2.66	1.10	4.76	1.38	0.79	1.08	0.16	FC836-8

FC836 Threaded In-Line Flow Control - BSPP

BSPP	Hex 1 mm	Hex 2 mm	H Closed	H Open	K	L	L1	N1	N2	T	Part Number
1/8	13	8	39.5	44.5	17.0	68.5	23.1	11.0	17.0	3.2	FC836-2G
1/4	16	11	44.0	50.0	18.5	83.0	25.9	12.5	20.0	3.2	FC836-4G
3/8	19	14	52.0	61.0	24.0	97.0	33.0	16.0	26.0	4.2	FC836-6G
1/2	24	14	57.5	67.5	28.0	121.0	35.0	20.0	27.5	4.2	FC836-8G

Flow Controls & Check Valves

Misc Accessories

Integrated Fittings

Accessories



Compact Metal Flow Control Valves

Metal flow control regulators are suited for use in severe conditions (temperatures, sparks, abrasion, etc). The screw and locking nut have been designed for easy manipulation, by hand. Adjustment can be made with a screwdriver and locking by use of a wrench.

Material Specifications

Body	Treated Brass
Gripping Ring	Stainless Steel
Adjustment Screws	Nickel-plated Brass
Locking Nut	Nickel-plated Brass
Tailpiece	Nickel-plated Brass

Applicable Tube

Tube O.D.	1/8, 5/32, 1/4, 3/8
Tube O.D. (mm)	4, 6, 8, 10, 12, 14

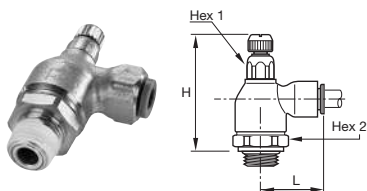

FC705 Push-to-Connect Metal Flow Control

Tube Size (in)	NPT	Hex 1 mm	Hex 2 mm	H Closed	H Open	L	Part Number
5/32	1/8	19	10	1.79	2.01	0.85	FC705-5/32-2
1/4	1/8	19	10	1.79	2.01	0.97	FC705-4-2
	1/4	19	10	1.79	2.01	0.97	FC705-4-4
3/8	1/4	19	14	1.91	2.11	1.14	FC705-6-4
	3/8	25	17	2.15	2.40	1.40	FC705-6-6

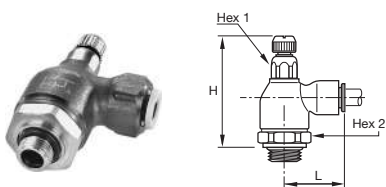

FC701 Push-to-Connect Metal Flow Control - BSPP

Tube Size (mm)	BSPP	Hex 1 mm	Hex 2 mm	H Closed	H Open	L	Part Number
4	1/8	10	19	47.0	53.0	21.0	FC701-4M-2G
	1/8	10	19	47.0	53.0	24.5	FC701-6M-2G
6	1/4	10	19	47.5	53.0	24.5	FC701-6M-4G
	1/8	14	19	50.0	55.0	29.0	FC701-8M-2G
8	1/4	14	19	50.0	56.0	29.0	FC701-8M-4G
	3/8	17	25	56.0	62.0	30.5	FC701-8M-6G
10	1/4	14	19	50.0	56.0	35.0	FC701-10M-4G
	3/8	17	25	56.0	62.0	35.0	FC701-10M-6G
12	3/8	17	25	56.0	62.0	38.0	FC701-12M-6G
	1/2	17	25	55.0	62.0	38.0	FC701-12M-8G
14	1/2	17	25	55.0	62.0	41.0	FC701-14M-8G



Operating information

Pressure range:	15 to 145 PSI
Temperature range:	30°F to 160°F
Working fluid:	Compressed air

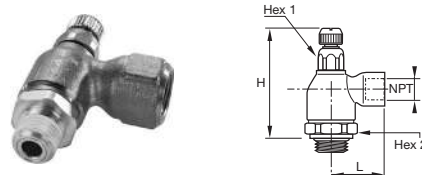

FC708 Threaded Port Meter Out Flow Control

NPT	Hex 1 mm	Hex 2 mm	H Closed	H Open	L	L1	L2	Part Number
1/8	19	10	1.79	2.01	0.89	0.87	1.14	FC708-2
1/4	19	14	1.91	2.11	1.28	0.87	1.28	FC708-4
3/8	25	17	2.15	2.40	1.36	0.91	1.44	FC708-6
1/2	25	17	2.15	2.40	1.50	0.91	1.50	FC708-8

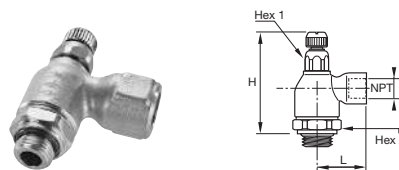

FC702 Threaded Port Meter Out Flow Control - BSPP

BSPP	Hex 1 mm	Hex 2 mm	H Closed	H Open	L	Part Number
1/8	10	19	47.0	52.5	22.5	FC702-2G
1/4	14	19	50.5	55.5	32.0	FC702-4G
3/8	17	25	56.0	62.0	34.5	FC702-6G
1/2	17	25	55.0	62.0	37.5	FC702-8G

Flow Control Check Valves

These in-line check valves allows air to pass in one direction while blocking flow in the other direction. Their extreme compactness and light weight make them suitable as a safety item in compressed air circuits. The body of the fitting contains an arrow to indicate the direction of flow.

Material Specifications

Body	32PLCK: Nylon/nickel plated brass 68PLCK: Nylon body with nickel-plated brass base VC: Acetal
Gripping Ring	Stainless Steel
O-ring	Nitrile (32PLCK & 68PLCK) EPDM (VC)

Applicable Tube

Tube O.D.	PLCK: 5/32, 1/4, 5/16, 3/8 VC: 1/4, 5/16, 3/8
Tube O.D. (mm)	PLCK: 4, 6, 8, 10, 12



Operating information

Pressure range:	15 to 145 PSI
Temperature range:	34°F to 150°F
Cracking pressure:	PLCK: 7 PSI VC: 1/3 PSI
Working fluid:	Compressed air

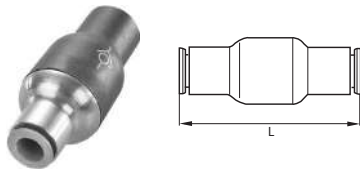

32PLCK In-Line Check Valve - NPT

Tube Size (In)	L	Part Number
5/32	1.52	32PLCK-5/32
1/4	1.61	32PLCK-4
5/16	2.03	32PLCK-5
3/8	2.50	32PLCK-6

32PLCK In-Line Check Valve - BSPP

Tube Size (mm)	L	Part Number
4	38.5	32PLCK-4M
6	41.0	32PLCK-6M
8	51.5	32PLCK-8M
10	63.5	32PLCK-10M
12	66.5	32PLCK-12M

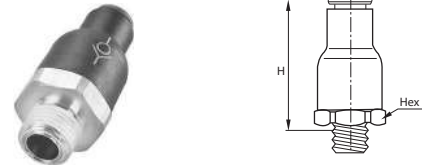

W68PLCK Male Check Valve

Tube Size (In)	NPT/ UNF	Hex mm	H	Part Number
5/32	10-32	9	1.26	68PLCK-5/32-0
5/32	1/8	16	1.12	W68PLCK-5/32-2
1/4	1/8	19	1.42	W68PLCK-4-2
1/4	1/4	19	1.42	W68PLCK-4-4
3/8	1/4	23	1.65	W68PLCK-6-4
3/8	3/8	23	1.65	W68PLCK-6-6

W68PLCKI Male Check Valve Meter In

Tube Size (in)	NPT/ UNF	Hex mm	H	Part Number
5/32	10-32	9	1.26	68PLCKI-5/32-0
5/32	1/8	16	1.12	W68PLCKI-5/32-2
1/4	1/8	19	1.42	W68PLCKI-4-2
1/4	1/4	19	1.42	W68PLCKI-4-4
3/8	1/4	23	1.65	W68PLCKI-6-4
3/8	3/8	23	1.65	W68PLCKI-6-6

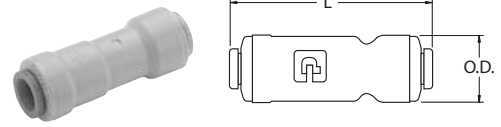
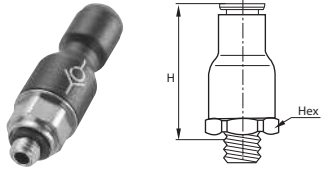

68PLCK Male Check Valve Meter Out - BSPP

Tube Size (mm)	BSPP	Hex 1 mm	H	Part Number
4	M5X0.8	9	32.0	68PLCK-4M-M5
4	1/8	16	28.5	68PLCK-4M-2G
6	1/8	16	30.5	68PLCK-6M-2G
6	1/4	16	30.5	68PLCK-6M-4G
8	1/8	19	36.0	68PLCK-8M-2G
8	1/4	19	36.0	68PLCK-8M-4G

VC - Check Valve

Tube Size (in)	BSPP	Hex 1 mm	Part Number
1/4	2.00	.66	A4VC4-MG
5/16	2.10	.70	A5VC5-MG
3/8	2.15	.80	A6VC6-MG

68PLCKI Male Check Valve Meter In - BSPP

Tube Size (mm)	BSPP	Hex 1 mm	H	Part Number
4	M5X0.8	9	32.0	68PLCKI-4M-M5
6	1/8	16	30.5	68PLCKI-6M-2G
8	1/8	19	36.0	68PLCKI-8M-2G
8	1/4	19	36.0	68PLCKI-8M-4G
10	3/8	23	42.0	68PLCKI-10M-6G
12	3/8	23	42.0	68PLCKI-12M-6G
12	1/2	23	44.0	68PLCKI-12M-8G

Flow Controls & Check Valves
 Misc Accessories
 Integrated Fittings
 Accessories



Blocking Flow Control Valves

Blocking valves prevents damage to work and equipment in the event of a loss of pressure. Blocking valves which are mounted in pairs on a cylinder lock the piston by simultaneously cutting off the supply and exhaust. Functional locks are more precise and rapid when blocking valves are located on the cylinder: the volume of air in the pipe work no longer needs to be taken into consideration.



Material Specifications

Body	Treated brass
Gripping Ring	Stainless Steel
Seals, Diaphragm	Nitrile

Applicable Tube

Tube O.D.	1/8, 5/32, 1/4, 3/8
Tube O.D. (mm)	4, 6, 8, 10, 12, 14

Operating information

Pressure range:	15 to 145 PSI
Temperature range:	-4°F to 160°F
Number of cycles:	> 10 million at 68°F and 1 Hz
Leak rate:	< 3.2 CCM
Working fluid:	Compressed air

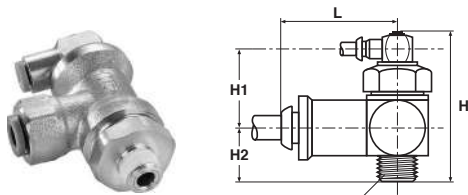

FC601 Push-to-Connect Lockout Valves

Tube Size (in)	NPT	Hex mm	H	H1	H2	L	Part Number
1/4	1/8	21	2.03	1.24	0.79	1.10	FC601-4-2
1/4	1/4	21	2.03	1.24	0.79	1.10	FC601-4-4
3/8	3/8	24	2.19	1.14	1.04	1.38	FC601-6-6
1/2	1/2	24	2.19	1.14	1.04	1.69	FC601-8-8

FC601 Push-to-Connect Lockout Valve - BSPP

Tube Size (mm)	BSPP	Hex 1 mm	H	H1	H2	L	Part Number
6	1/8	21	53	24.5	21.0	28.0	FC601-6M-2G
6	1/4	21	53	24.5	21.0	28.0	FC601-6M-4G
8	1/4	21	53	24.5	21.0	28.0	FC601-8M-4G
8	3/8	24	56	25.0	23.0	34.5	FC601-8M-6G
10	3/8	24	56	25.0	23.0	35.0	FC601-10M-6G
12	1/2	24	56	25.0	23.0	37.5	FC601-12M-8G

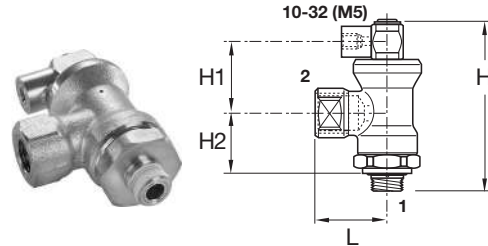

FC602 Threaded Port Lockout Valves

1 NPT	2 NPT	Hex mm	H	H1	H2	L	Part Number
1/4	1/8	21	2.03	1.24	0.79	1.04	FC602-2
1/4	1/4	21	2.03	1.24	0.79	1.04	FC602-4
3/8	3/8	24	2.19	1.14	1.04	1.34	FC602-6
1/2	1/2	24	2.19	1.14	1.04	1.57	FC602-8

FC608 Threaded Port Lockout Valve - BSPP

1 BSPP	2 BSPP	Hex 1 mm	H	H1	H2	L	Part Number
1/8	1/4	21	53	24.5	21.0	28.0	FC608-4G-2G
1/4	1/4	21	53	24.5	21.0	28.0	FC608-4G-4G
3/8	3/8	24	56	25.0	23.0	34.0	FC608-6G-6G
1/2	1/2	24	56	25.0	23.0	41.0	FC608-8G-8G

Flow Controls
& Check Valves

Misc
Accessories

Integrated
Fittings

Accessories

F

Threshold Sensor

The sensor fitting detects the absence of pressure and translates it to a high pressure pneumatic output. When used to monitor the decaying or exhausting side of a pneumatic cylinder's piston, it emits a positive output. When the cylinder comes to the end of its stroke, wherever that may be, the signal emitted from the sensor can then be used to pilot the next step.



Operating information

	PSBJ, PSPJ	PSPE
Working pressure:	45 to 115 PSI	45 to 115 PSI
Breaking pressure:	8.5 PSI	7 PSI
Working temperature:	5°F to 140°F	–
Response time:	3 Ms	–
Current rating:	–	5A / 250VAC 5W / 48VDC
Reset pressure:	10 PSI	10 PSI
UL listed component		

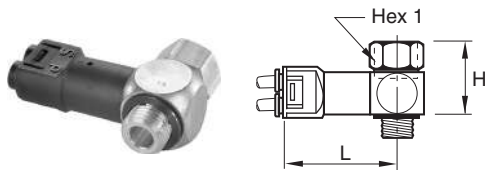

PSBJ731 Pneumatic Threshold Sensor - 5/32 Pilot

NPT / UNF	Hex 1 mm	H	L	Part Number
10-32	5/16	0.62	1.70	PSBJ731-0
1/8	9/16	0.90	1.74	PSBJ731-2
1/4	5/8	1.09	1.81	PSBJ731-4
3/8	7/8	1.13	1.91	PSBJ731-6
1/2	1	1.17	2.05	PSBJ731-8

PSBJ731 Pneumatic Threshold Sensor - 4mm Pilot

BSPP	Hex 1 mm	H	L	Part Number
M5X0.8	8	16	43.5	PSBJ731-M5
1/8	14	23	44.5	PSBJ731-2G
1/4	17	28	46.5	PSBJ731-4G
3/8	22	29	49.0	PSBJ731-6G
1/2	27	30	52.5	PSBJ731-8G

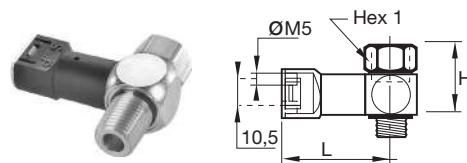

PSPJ731 Pneumatic Threshold Sensor - 10-32 Pilot

NPT	Hex 1 mm	H	L	Part Number
1/8	9/16	0.90	1.58	PSPJ731-2
1/4	5/8	1.09	1.66	PSPJ731-4
3/8	7/8	1.13	1.76	PSPJ731-6

PSBJ708 Pneumatic Threshold Sensor - M5 Pilot

BSPP	Hex 1 mm	H	L	Part Number
1/8	14	23	40.5	PSBJ708-2G
1/4	17	28	42.5	PSBJ708-4G

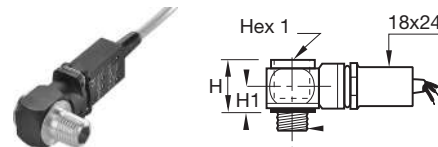

PSPE701 Pneumatic / Electric Threshold Sensor - BSPP

NPT	Hex 1 mm	H	H1	L	Part Number
M5X0.8	8	20	10	49	PSPE701-M5
1/8	6	20	10	52	PSPE701-2G
1/4	8	20	10	54	PSPE701-4G
3/8	10	22	12	57	PSPE701-6G
1/2	12	26	14	58	PSPE701-8G

**Fax Forms, Part Number Index,
Safety Guide, Offer of Sale**

Part Number Index	G2-G26
Safety Guide	G27-G28
Offer of Sale	G29



For inventory, lead times, and kit lookup, visit www.pdnplu.com

Model No.	Section / Page No.	Model No.	Section / Page No.	Model No.	Section / Page No.	Model No.	Section / Page No.
3371000.....	F2, F3	33408000.....	F14	410811000.....	E3	523831000.....	E4
3371001.....	F2, F3	34750109.....	F14	410821000.....	E3	524211000.....	E4
3371002.....	F2, F3	34750120.....	F14	410931000.....	E3	524251000.....	E4
3371003.....	F2, F3	34759000.....	F14	410941000.....	E3	524411000.....	E3
3371004.....	F2, F3	36408000.....	F14	410951000.....	E3	524431000.....	E3
3378000.....	F2, F3	36408100.....	F14	414111000.....	E5	524451000.....	E3
3378001.....	F2, F3	36508000.....	F14	414121000.....	E5	524711000.....	E5
3378002.....	F2, F3	45020002.....	F8	414151000.....	E5	524751000.....	E5
3378003.....	F2, F3	45040004.....	F8	414211000.....	E4	524811000.....	E4
3378004.....	F2, F3	45060060.....	F8	414221000.....	E4	524831000.....	E4
3393000.....	F7	45080080.....	F8	414251000.....	E4	524931000.....	E5
3393001.....	F7	45120012.....	F8	414311000.....	E5	529811000.....	E4
3393002.....	F7	45160016.....	F8	414321000.....	E5	529831000.....	E4
3393003.....	F7	47020002.....	F9	414351000.....	E5	9121658063.....	C6
3393004.....	F7	47040004.....	F9	414411000.....	E3	9121658068.....	C6
4700010.....	F21	47060006.....	F9	414421000.....	E3	9121658075.....	C6
4700900.....	F21	47080008.....	F9	414451000.....	E3	9121658076.....	C6
4707020.....	F22	47120012.....	F9	414711000.....	E5	9121658077.....	C6
4750010.....	F21	47160016.....	F9	414721000.....	E5	9121658078.....	C6
4750900.....	F21	47200020.....	F9	414751000.....	E5	00339G3000.....	F7
6450060.....	F20	47240024.....	F9	414811000.....	E3	00339G3001.....	F7
8230299.....	E63, E64, E65	67390000.....	F20, F22	414821000.....	E3	0220 19 00.....	C87
8240109.....	E63, E64, E65	91660060.....	F20	414931000.....	E3	OR12B.....	F14
32130599..	E63, E64, E65, E66	404111000.....	E5	414941000.....	E3	OR12NB.....	F14
32130899.....	E63, E64, E65	404118000.....	E7	414951000.....	E3	OR12NVB.....	F14
32140299.....	E63	404211000.....	E4	520008050.....	E7	OR12VB.....	F14
32500119.....	F4	404311000.....	E5	520008500.....	E7	OR25B.....	F14
32500219.....	F4	404411000.....	E3	520018005.....	E7	OR25NB.....	F14
32500319.....	F4	404711000.....	E5	520211000.....	E4	OR25NFB.....	F14
32500419.....	F4	404811000.....	E3	520251000.....	E4	OR25PB.....	F14
32500519.....	F4	410008000.....	E7	520411000.....	E3	OR25VB.....	F14
32501500.....	F5	410008005.....	E7	520431000.....	E3	OR37B.....	F14
32510125.....	F6	410111000.....	E5	520451000.....	E3	OR37FB.....	F14
32510250.....	F6	410121000.....	E5	520711000.....	E5	OR37TB.....	F14
32510375.....	F6	410151000.....	E5	520718001.....	E7	OR37VB.....	F14
32510500.....	F6	410211000.....	E4	520751000.....	E5	OR50B.....	F14
32511215.....	F6	410221000.....	E4	520811000.....	E4	OR50VB.....	F14
32511225.....	F6	410251000.....	E4	520831000.....	E4	OR75B.....	F14
32512525.....	F6	410411000.....	E3	520838004.....	E7	OR75FB.....	F14
32512538.....	F6	410421000.....	E3	520931000.....	E5	OR75VB.....	F14
32513838.....	F6	410451000.....	E3	521811000.....	E4	ORB12B.....	F14
33400105.....	F14	410711000.....	E5	521831000.....	E4	ORB12NB.....	F14
33400319.....	F14	410721000.....	E5	522811000.....	E4	ORB12NVB.....	F14
33400504.....	F14	410751000.....	E5	522831000.....	E4	ORB12VB.....	F14

Part Number Index
 Safety Guide
 Offer of Sale
 Part Number Index,
 Safety Guide, Offer of Sale



For inventory, lead times, and kit lookup, visit www.pdnplu.com

Model No.	Section / Page No.	Model No.	Section / Page No.	Model No.	Section / Page No.	Model No.	Section / Page No.
ORB25B	F14	5500A4004	E54	9121594809X	C6, C21	A05RAIEM5	C86
ORB25NB	F14	5500A4004	F10	9121594812X	C6	A05RAISM5	C86
ORB25NFB	F14	5500A6004	F10	9121594812XN	C6	A05RAXIEM5	C86
ORB25VB	F14	5500A9004	E54	9121658068N	C6	A05RAXISM5	C86
ORB37B	F14	5500A9004	F10	9121658075N	C6	A05RBF	C87
ORB37FB	F14	5500B6004	E54	9121658076N	C6	A05RBS	C87
ORB37TB	F14	5599-1	D270	9121658077N	C6	A05RD251PM5MF	C82
ORB37VB	F14	62PM	D26, D27	9121658078N	C6	A05RG	C87
ORB50B	F14	68PLCK	F23	988A30	E54	A05RGBP	C86
ORB50VB	F14	68PLCK-4M-2G	F34		A	A05RS	C87
ORB75B	F14	68PLCK-4M-M5	F34	A00S	C89	A05RS251PM5MF	C82
ORB75FB	F14	68PLCK-5/32-0	F33	A00S-B-M3	C85	A12P	C91
ORB75VB	F14	68PLCK-6M-2G	F34	A00SBP	C86	A12PAIEN1	C86
1155H30	E54	68PLCK-6M-4G	F34	A00SC23-1P	C85	A12PAISN1	C86
1738-EXT1	D192	68PLCK-8M-2G	F34	A00SG	C87	A12PAXIEN1	C86
1738-EXT3	D192	68PLCK-8M-4G	F34	A00SS	C87	A12PAXISN1	C86
3250G1000	F5	68PLCKI	F23	A05P	C89, C91	A12PBG2	C83
3250G1250	F5	68PLCKI-10M-6G	F34	A05P-AC-CL10	C86	A12PBN2	C83
3250G1500	F5	68PLCKI-12M-6G	F34	A05P-AC-CL5	C86	A12PD252P	C82
32PLCK	F23	68PLCKI-12M-8G	F34	A05PAIEM5	C86	A12PG	C87
32PLCK-10M	F33	68PLCKI-4M-M5	F34	A05PAISM5	C86	A12PGBP	C86
32PLCK-12M	F33	68PLCKI-5/32-0	F33	A05PAXIEM5	C86	A12PS	C87
32PLCK-4	F33	68PLCKI-6M-2G	F34	A05PAXISM5	C86	A12PS251P	C82
32PLCK-4M	F33	68PLCKI-8M-2G	F34	A05PBG1	C83	A12PS252P	C82
32PLCK-5	F33	68PLCKI-8M-4G	F34	A05PBN1	C83	A12PXG	C87
32PLCK-5/32	F33	91213202SXZ	C6	A05PD251P	C82	A12R	C89, C91
32PLCK-6	F33	91213202SXZN	C6	A05PDCC	C86	A12RABG1	C87
32PLCK-6M	F33	91213204SXZ	C6	A05P-DC-CB10	C86	A12RABN1	C87
32PLCK-8M	F33	91213204SXZN	C6	A05P-DC-CL10	C86	A12RAIEN1	C86
422CR021K	E19	91213206SXZ	C6	A05P-DC-CL30	C86	A12RAISN1	C86
422CR021W	E19	91213206SXZN	C6	A05P-DC-CL5	C86	A12RAXIEN1	C86
422CR023W	E19	91213208SXZ	C6	A05PDCCM	C86	A12RAXISN1	C86
422CR024W	E19	91213208SXZN	C6	A05PG	C87	A12RBF	C87
422CS021K	E19	91213210SXZ	C6	A05PG-BP	C86	A12-RBS	C87
422CS021W	E19	91213210SXZN	C6	A05PLA	C86	A12RD252PN1MF	C82
422CS023W	E19	912132BPSXZ	C6	A05PLB	C86	A12RG	C87
422CS024W	E19	9121594805X	C6	A05PN	C87	A12RGBP	C86
422CT021K	E19	9121594805XN	C6	A05PS	C87	A12RS	C87
520A11000	E4	9121594806X	C6	A05PS251P	C82	A12RS252PN1MF	C82
520A51000	E4	9121594806XN	C6	A05PSCC	C86	A4VC4-MG	F34
524A11000	E4	9121594807X	C6	A05PSCCM	C86	A5VC5-MG	F34
524A51000	E4	9121594807XN	C6	A05PXG	C87	A6VC6-MG	F34
5500A2004	E54	9121594808X	C6	A05R	C90	AAH3S003	D118
5500A2004	F10	9121594808XN	C6	A05RABM5	C87	AAHMD5249MOM	D9

Part Number Index

Safety Guide

Offer of Sale

Part Number Index, Safety Guide, Offer of Sale



For inventory, lead times, and kit lookup, visit www.pdnplu.com

Model No.	Section / Page No.	Model No.	Section / Page No.	Model No.	Section / Page No.	Model No.	Section / Page No.
AAHMT5129M0M	D10	B320BB549C	C40	B612BB553A	C40	BL67-1CVI	D210, D211, D214, D221
AAHMT5129M0M	D11	B320BB553C	C40	B622BB549A	C40	BL67-1RS232	D210, D211, D214, D220
AAHMX5209M0M	D11	B330000XXC	C42	B622BB553A	C40	BL67-1RS485/422	D210, D211, D214, D220
AAHU31L000P04	D111	B340000XXC	C42	B632000XXA	C42	BL67-1RSM-VO	D210
AAPL2AXGAXG##NP	C21	B350BB549C	C41	B642000XXA	C42	BL67-1SSI	D210, D211, D214, D221
AAPL2AXGAXN##NP	C21	B350BB553C	C41	B652BB549A	C41	BL67-2AI2AO-V/I	D214, D219
AAPL2AXMAXG##NP	C21	B360BB549C	C41	B652BB553A	C41	BL67-2AI-I	D210, D211, D213, D218
AAPL2AXMAXN##NP	C21	B360BB553C	C41	B662BB549A	C41	BL67-2AI-PT	D210, D211, D213, D218
AAPL2BXGAXG##NP	C21	B370BB549C	C41	B662BB553A	C41	BL67-2AI-TC	D210, D211, D213, D218
AAPL2BXGAXN##NP	C21	B370BB553C	C41	B672BB549A	C41	BL67-2AI-V	D210, D211, D213, D218
AAPL2BXMAGG##NP	C21	B380000XXC	C42	B672BB553A	C41	BL67-2AO-I	D210, D211, D213, D219
AAPL2BXMAGN##NP	C21	B380000XXC	C42	B672BB553A	C41	BL67-2AO-V	D210, D211, D213, D219
AAPL2BXMAGN##NP	C21	B3G0BB549C	C40	B682000XXA	C42	BL67-2RFID-A	D210
AAPL2CXMAXG##NP	C21	B3G0BB553C	C40	B713BB549A	C60	BL67-2RFID-C	D210
AAPL2CXMAXN##NP	C21	B511BB549C	C40	B713BB553A	C60	BL67-4AI4AO-V/I	D214, D219
AS-10	C28, E17, F11	B511BB553C	C40	B723BB549A	C60	BL67-4AI-I/V	D211
AS-15	C28, E17, F11	B512BB549C	C40	B723BB553A	C60	BL67-4AI-V/I	D210, D213, D218, D219
AS-5	C28, E17, F11	B512BB553C	C40	B753BB549A	C61	BL67-4AO-V	D213
AS-6	C28, E17, F11	B521BB549C	C40	B753BB553A	C61	BL67-4DI4DO-PD	D210, D211, D212, D215
AS-8	C28, E17, F11	B521BB553C	C40	B763BB549A	C61	BL67-4DI-P	D210, D211, D212, D215
ASC/ASO500	C72	B522BB549C	C40	B763BB553A	C61	BL67-4DI-PD	D210, D211, D212, D215
ASC500	C74	B522BB553C	C40	B773BB549A	C61	BL67-4DO-0.5A-P	D210, D211, D212, D216
ASC500-1W-10	C80	B531000XXC	C42	B773BB553A	C61	BL67-4DO-2A-N	D210, D211, D212, D216
ASC500-1W-90	C80	B532000XXC	C42	B7V3BB549A	C60	BL67-4DO-2A-P	D210, D211, D212, D216
ASC-D24-CL10	C80	B541000XXC	C42	B7V3BB553A	C60	BL67-4DO-4A-P	D212
ASN-10	C28, E17, F11	B542000XXC	C42	B7X3000XXA	C42	BL67-8DI-N	D210, D211, D212, D215
ASN-15	C28, E17, F11	B551BB549C	C41	B814BB549A	C60	BL67-8DI-P	D210, D211, D212, D215
ASN-6	C28, E17, F11	B551BB553C	C41	B814BB553A	C60		
ASN-8	C28, E17, F11	B552BB549C	C41	B824BB549A	C60		
ASO500	C74	B552BB553C	C41	B824BB553A	C60		
ASO500-1W-10	C80	B561BB549C	C41	B854BB549A	C61		
ASO500-1W-90	C80	B561BB553C	C41	B854BB553A	C61		
ASV13000	C74	B562BB549C	C41	B864BB549A	C61		
ASV15000	C74	B562BB553C	C41	B864BB553A	C61		
ASV200	C72, C74	B571BB549C	C41	B874BB549A	C61		
ASV2000	C72, C74	B571BB553C	C41	B874BB553A	C61		
ASV2000-AA-17	C76	B572BB549C	C41	B8V4BB549A	C60		
ASV2000-AA-97	C76	B572BB553C	C41	B8V4BB553A	C60		
ASV200-AA-M5	C75	B581000XXC	C42	BC03M3	C87		
ASV5000	C72, C74	B582000XXC	C42	BC03M5	C87		
ASV5000-AA-21	C77	B5G1BB549C	C40	BC04M3	C87		
ASV5000-AA-91	C77	B5G1BB553C	C40	BL67-16DO-0.1A-P	D210, D211, D213, D216		
	B	B5G2BB549C	C40	BL67-1CNT/ENC	D210, D211, D214, D221		
B310BB549C	C40	B5G2BB553C	C40				
B310BB553C	C40	B612BB549A	C40				

Part Number Index
 Safety Guide
 Offer of Sale
 Part Number Index,
 Safety Guide, Offer of Sale



For inventory, lead times, and kit lookup, visit www.pdnplu.com

Model No.	Section / Page No.	Model No.	Section / Page No.	Model No.	Section / Page No.	Model No.	Section / Page No.
BL67-8DI-PD.....	D210, D212, D215	C		DX01M2MGSKT....	D235, D244	DX2-611-CL49.....	D246
BL67-8-DI-PD.....	D211	CMD04-1.....	D34, D38, D42, D54	DX02-406-60.....	D234, D246	DX2-611-CL53.....	D246
BL67-8DO-0.5A-N.....	D210, D211, D212, D216	CMD06-1.....	D34, D38, D42, D54	DX02-411-60.....	D234, D246	DX2-616-BL49.....	D246
BL67-8DO-0.5A-P.....	D210, D211, D212, D216	CMD06-2.....	D34, D38, D42, D54	DX02-416-60.....	D234, D246	DX2-616-BL53.....	D246
BL67-8DO-R-NO.....	D210, D211, D213, D217	CMD07-1B.....	D34, D38, D42, D54, D61	DX02-421-60.....	D234, D246	DX2-616-CL49.....	D246
BL67-8XSG-PD....	D210, D211, D213	CMD07-2B.....	D34, D38, D42, D54	DX02-451-60.....	D234, D246	DX2-616-CL53.....	D246
BL-67-8XSG-PD.....	D217	CMD08-2.....	D34, D38, D42, D54	DX02-606-951J.....	D234	DX2-621-BL49.....	D246
BL67-B-1M12.....	D210, D214	CMD09-2B.....	D34, D38, D42, D54	DX02-606-951M.....	D234	DX2-621-BL53.....	D246
BL67-B-1M12-8....	D210, D214	CMD10-2.....	D34, D38, D42, D54	DX02-611-951J.....	D234	DX2-621-CL49.....	D246
BL67-B-1M23.....	D210, D212, D214	CMD12-2.....	D34, D38, D42, D54	DX02-611-951M.....	D234	DX2-621-CL53.....	D246
BL67-B-1M23-19..	D210, D213	CSCM CKCM 12-11-x/S90.....	D225	DX02-616-951J.....	D234	DX2-651-BL49.....	D246
BL67-B-1RSM.....	D210, D214, D223	CSM CKM 19-19-x/S90.....	D225	DX02-616-951M.....	D234	DX2-651-BL53.....	D246
BL67-B-1RSM-4...	D210, D214, D223	CSWM CKWM 19-19-x/ CS12852.....	D225	DX02-621-951J.....	D234	DX2-651-CL49.....	D246
BL67-B-1RSM-VO	D214, D223			DX02-621-951M.....	D234	DX2-651-CL53.....	D246
BL67-B-2M12.....	D210, D212, D213	D		DX02-651-951J.....	D234	DX3-406-60.....	D247
BL67-B-2M12-P....	D210, D212	D01BD0.....	D244	DX02-651-951M.....	D234	DX3-411-60.....	D247
BL67-B-4M12.....	D210, D212, D213, D214	D01P-02-80.....	D244	DX02M2MB.....	D235, D244	DX3-416-60.....	D247
BL67-B-4M12P.....	D213	D02BD0.....	D244	DX02M2MGSKT.....	D244	DX3-421-60.....	D247
BL67-B-4M12-P...	D210, D212, D213	D02P-01-80.....	D244	DX1-606-BL49.....	D245	DX3-421-60.....	D247
BL67-B-4M8.....	D210, D212	DSS25FB1.....	C86	DX1-606-BL53.....	D245	DX3-451-60.....	D247
BL67-B-8M8.....	D210, D212, D213, D214	DX ISOMAX Series.....	D233	DX1-606-CL49.....	D245	DX3-606-BL49.....	D247
BL67-GW-CO.....	D208	DX01-406-60.....	D235, D245	DX1-606-CL53.....	D245	DX3-606-BL53.....	D247
BL67-GW-DN.....	D208	DX01-411-60.....	D235, D245	DX1-611-BL49.....	D245	DX3-606-CL49.....	D247
BL67-GW-DPV1.....	D208	DX01-416-60.....	D235, D245	DX1-611-BL53.....	D245	DX3-611-BL49.....	D247
BL67-GW-EN.....	D208	DX01-421-60.....	D235, D245	DX1-611-CL49.....	D245	DX3-611-BL53.....	D247
BL67-GW-EN-DN.....	D209	DX01-451-60.....	D235, D245	DX1-611-CL53.....	D245	DX3-611-CL49.....	D247
BL67-GW-EN-IP-DN.....	D209	DX01-606-951J.....	D235	DX1-616-BL49.....	D245	DX3-611-CL53.....	D247
BL67-GW-EN-PN.....	D208	DX01-606-951M.....	D235	DX1-616-BL53.....	D245	DX3-616-BL49.....	D247
BL67-PF-24VDC.....	D210, D211, D214, D220, D223	DX01-611-951J.....	D235	DX1-616-CL49.....	D245	DX3-616-BL53.....	D247
BL67-PG-DP.....	D209	DX01-611-951M.....	D235	DX1-616-CL53.....	D245	DX3-616-CL49.....	D247
BL67-PG-EN.....	D209	DX01-616-951J.....	D235	DX1-621-BL49.....	D245	DX3-616-CL53.....	D247
BL67-PG-EN-DN.....	D209	DX01-616-951M.....	D235	DX1-621-BL53.....	D245	DX3-621-BL49.....	D247
BL67-PG-EN-IP.....	D209	DX01-621-951J.....	D235	DX1-621-CL49.....	D245	DX3-621-BL53.....	D247
BL67-PG-EN-IP-DN.....	D209	DX01-621-951M.....	D235	DX1-621-CL53.....	D245	DX3-621-CL49.....	D247
		DX01-651-951J.....	D235	DX1-651-BL49.....	D245	DX3-621-CL53.....	D247
		DX01-651-951M.....	D235	DX1-651-BL53.....	D245	DX3-651-BL49.....	D247
				DX1-651-CL49.....	D245	DX3-651-BL53.....	D247
				DX1-651-CL53.....	D245	DX3-651-CL49.....	D247
				DX2-606-BL49.....	D246	DX3-651-CL53.....	D247
				DX2-606-BL53.....	D246	E	
				DX2-606-CL49.....	D246	E90016.....	C28, E17
				DX2-606-CL53.....	D246	E90017.....	C28, E17
				DX2-611-BL49.....	D246	ECS3.....	F13
				DX2-611-BL53.....	D246	ECS5.....	F13

Part Number Index
Safety Guide
Offer of Sale
Part Number Index, Safety Guide, Offer of Sale



For inventory, lead times, and kit lookup, visit www.pdnplu.com

Model No.	Section / Page No.	Model No.	Section / Page No.	Model No.	Section / Page No.	Model No.	Section / Page No.
EM100	F8	FC602	F24	FC832-4M	F30	FCCB731-6M-2G	F25
EM12	C28, C87, E17, F8	FC602-2	F35	FC832-5	F30	FCCB731-6M-4G	F25
EM125	F8	FC602-4	F35	FC832-5/32	F30	FCCB731-8M-2G	F25
EM150	F8	FC602-6	F35	FC832-6	F30	FCCB731-8M-4G	F25
EM25	C28, C87, E17, F8	FC602-8	F35	FC832-6M	F30	FCCB731-8M-6G	F25
EM37	C28, E17, F8	FC608	F24	FC832-8	F30	FCCS731	F23
EM50	C28, E17, F8	FC608-4G-2G	F35	FC832-8M	F30	FCCS731-10M-4G	F28
EM75	F8	FC608-4G-4G	F35	FC836	F23	FCCS731-10M-6G	F28
EMM5	F8	FC608-6G-6G	F35	FC836-2	F31	FCcS731-12M-6G	F28
ES100MC	E54, F9	FC608-8G-8G	F35	FC836-2G	F31	FCcS731-12M-8G	F28
ES125MC	E54, F9	FC701	F23	FC836-4	F31	FCCS731-4-2	F28
ES12MC	F9	FC701-10M-4G	F32	FC836-4G	F31	FCCS731-4-4	F28
ES150MC	E54, F9	FC701-10M-6G	F32	FC836-6	F31	FCCS731-6-4	F28
ES200MC	E54	FC701-12M-6G	F32	FC836-6G	F31	FCCS731-6-6	F28
ES25MC	E54, F9	FC701-12M-8G	F32	FC836-8	F31	FCCS731-6M-2G	F28
ES37MC	E54, F9	FC701-14M-8G	F32	FC836-8G	F31	FCcS731-6M-4G	F28
ES50MC	E54, F9	FC701-4M-2G	F32	FCB832	F23	FCcS731-8M-2G	F28
ES75MC	E54, F9	FC701-6M-2G	F32	FCB832-4	F30	FCCS731-8M-4G	F28
ESB100MC	F9	FC701-6M-4G	F32	FCB832-4M	F30	FCcS731-8M-6G	F28
ESB125MC	F9	FC701-8M-2G	F32	FCB832-5	F30	FCCSP731	F23
ESB12MC	F9	FC701-8M-4G	F32	FCB832-5/32	F30	FCCSP731-10M	F29
ESB150MC	F9	FC701-8M-6G	F32	FCB832-6M	F30	FCCSP731-12M	F29
ESB25MC	F9	FC702	F23	FCB832-8M	F30	FCCSP731-6M	F29
ESB37MC	F9	FC702-2G	F32	FCC731	F23	FCCSP731-8M	F29
ESB50MC	F9	FC702-4G	F32	FCC731-10M-4G	F25	FCKC731	F23
ESB75MC	F9	FC702-6G	F32	FCC731-10M-6G	F25	FCKC731-10M-4G	F26
EZ03NB6	E52	FC702-8G	F32	FCC731-12M-6G	F25	FCKC731-10M-6G	F26
EZ04NB6	E52	FC705	F23	FCC731-12M-8G	F25	FCKC731-10M-8G	F26
EZ06NB6	E52	FC705-4-2	F32	FCC731-4-2	F25	FCKC731-12M-6G	F26
EZ06NBA	E52	FC705-4-4	F32	FCC731-4-4	F25	FCKC731-12M-8G	F26
EZ08NBA	E52	FC705-5/32-2	F32	FCC731-4M-2G	F25	FCKC731-2-0	F26
EZOANBA	E52	FC705-6-4	F32	FCC731-5/32-2	F25	FCKC731-2-2	F26
	F	FC705-6-6	F32	FCC731-5/32-4	F25	FCKC731-4-0	F26
FC601	F24	FC708	F23	FCC731-6-4	F25	FCKC731-4-2	F26
FC601-10M-6G	F35	FC708-2	F32	FCC731-6-6	F25	FCKC731-4-4	F26
FC601-12M-8G	F35	FC708-4	F32	FCC731-6M-2G	F25	FCKC731-4M-2G	F26
FC601-4-2	F35	FC708-6	F32	FCC731-6M-4G	F25	FCKC731-4M-M5	F26
FC601-4-4	F35	FC708-8	F32	FCC731-8M-2G	F25	FCKC731-5/32-0	F26
FC601-6-6	F35	FC800-5/32	D9	FCC731-8M-4G	F25	FCKC731-5/32-2	F26
FC601-6M-2G	F35	FC832	F23	FCC731-8M-6G	F25	FCKC731-5-2	F26
FC601-6M-4G	F35	FC832-10M	F30	FCCB731	F23	FCKC731-5-4	F26
FC601-8-8	F35	FC832-12M	F30	FCCB731-4-2	F25	FCKC731-6-4	F26
FC601-8M-4G	F35	FC832-4	D9	FCCB731-4M-2G	F25	FCKC731-6-6	F26
FC601-8M-6G	F35	FC832-4	F30	FCCB731-5/32-2	F25	FCKC731-6M-2G	F26

Part Number Index
 Safety Guide
 Offer of Sale
 Part Number Index,
 Safety Guide, Offer of Sale



For inventory, lead times, and kit lookup, visit www.pdnplu.com

Model No.	Section / Page No.	Model No.	Section / Page No.	Model No.	Section / Page No.	Model No.	Section / Page No.
FCKC731-6M-4G.....	F26	FCMK731-4-4.....	F27	H02789.....	D291	H11VXXH0B9D.....	D78
FCKC731-6M-M5.....	F26	FCMK731-5/32-0.....	F27	H05028.....	E28, E29	H11WXBBL49D.....	D100
FCKC731-8M-2G.....	F26	FCMK731-5/32-2.....	F27	H05029.....	E29	H11WXBBL53D.....	D101
FCKC731-8M-4G.....	F26	FCMS731.....	F23	H06326.....	C105, C106, C109, C110	H11WXBDL49D.....	D100
FCKC731-8M-6G.....	F26	FCMS731-4M-2G.....	F28	H06332.....	C105, C106, C109, C110	H11WXBDL53D.....	D101
FCKCB731.....	F23	FCMS731-4M-M5.....	F28	H06338.....	C107, C108, C109, C110	H11WXBG2B9000FD.....	D100
FCKCB731-4M-2G.....	F26	FCMS731-5/32-0.....	F28	H06416.....	E31	H11WXBG323000FD.....	D100
FCKCB731-4M-M5.....	F26	FCMS731-5/32-2.....	F28	H07229.....	E28, E29	H11WXBH2B9000FD.....	D100
FCKCB731-6M-2G.....	F26	FCMS731-6M-2G.....	F28	H07230.....	E28	H11WXBH323000FD.....	D100
FCKCB731-6M-4G.....	F26	FCMS731-6M-M5.....	F28	H07254.....	E32	H11WXXBL49D.....	D101
FCKCB731-6M-M5.....	F26	FCMSP701.....	F23	H07270.....	E32	H11WXXBL53D.....	D101
FCKCB731-8M-2G.....	F26	FCMSP701-4M.....	F29	H07271.....	E32	H11WXXDL49D.....	D100
FCKCB731-8M-4G.....	F26	FCMSP701-6M.....	F29	H08903.....	E28, E29	H11WXXDL53D.....	D101
FCKCB731-8M-6G.....	F26	FCMSP731.....	F23	H09012.....	E32	H11WXXG2B9000FD.....	D100
FCM731.....	F23	FCMSP731-2.....	F29	H09025.....	E32	H11WXXH2B9000FD.....	D100
FCM731-2-0.....	F27	FCMSP731-4.....	F29	H09626.....	E32, E33	H11WXXH323000FD.....	D100
FCM731-2-2.....	F27	FCMSP731-5/32.....	F29	H09645.....	E32, E33	H12VXBG023D.....	D78
FCM731-3M-M3.....	F27	FCPM832.....	F23	H09706.....	E32, E33	H12VXBG0B9D.....	D78
FCM731-3M-M5.....	F27	FCPM832-10M.....	F31	H09815.....	D289	H12VXBH023D.....	D78
FCM731-4-0.....	F27	FCPM832-12M.....	F31	H100107.....	D289	H12VXBH0B9D.....	D78
FCM731-4-2.....	F27	FCPM832-4M.....	F31	H10032.....	D289	H12VXXG023D.....	D78
FCM731-4-4.....	F27	FCPM832-6M.....	F31	H10069.....	D289	H12VXXG0B9D.....	D78
FCM731-4M-2G.....	F27	FCPM832-8M.....	F31	H10115.....	E31	H12VXXH023D.....	D78
FCM731-4M-M3.....	F27	FMD04-1.....	D34, D38, D42, D54	H10117.....	E30	H12VXXH0B9D.....	D78
FCM731-4M-M5.....	F27	FMD06-1.....	D34, D38, D42, D54	H10119.....	E31	H12WXBBL49D.....	D100
FCM731-5/32-0.....	F27	FMD06-2.....	D34, D38, D42, D54	H10121.....	E30	H12WXBBL53D.....	D101
FCM731-5/32-2.....	F27	FMD07-1B.....	D34, D38, D42, D45, D54, D56, D61	H10145.....	E30, E31	H12WXBBDL49D.....	D100
FCM731-6M-2G.....	F27	FMD07-2B.....	D34, D38, D42, D54	H10147.....	E30	H12WXBBDL53D.....	D101
FCM731-6M-4G.....	F27	FMD08-2.....	D34, D38, D42, D54	H10215.....	E30	H12WXBG2B9000FD.....	D100, D111
FCM731-6M-M5.....	F27	FMD09-2B.....	D34, D38, D42, D54, D61	H10217.....	E31	H12WXBG323000FD.....	D100
FCM731-8M-2G.....	F27	FMD10-2.....	D34, D38, D42, D54	H10219.....	E30	H12WXBH2B9000FD.....	D100
FCM731-8M-4G.....	F27	FMD12-2.....	D34, D38, D42, D54	H11215.....	E32	H12WXBH323000FD.....	D100
FCM731-8M-6G.....	F27	FMD13-2B.....	D34, D42, D54	H11216.....	E32	H12WXXBL49D.....	D100
FCMB731.....	F23	H		H11217.....	E32	H12WXXBL53D.....	D101
FCMB731-4M-2G.....	F27	H Series ISO.....	D71	H11333.....	E31	H12WXXDL49D.....	D100
FCMB731-4M-M5.....	F27	H02713.....	D291	H11VXBG023D.....	D78	H12WXXDL53D.....	D101
FCMB731-6M-2G.....	F27	H02722.....	D291	H11VXBG0B9D.....	D78	H12WXXG2B9000FD.....	D100
FCMB731-6M-4G.....	F27	H02723.....	D291	H11VXBH023D.....	D78	H12WXXG323000FD.....	D100
FCMB731-6M-M5.....	F27			H11VXBH0B9D.....	D78	H12WXXH2B9000FD.....	D100
FCMK731.....	F23			H11VXXG023D.....	D78	H12WXXH323000FD.....	D100
FCMK731-2-0.....	F27			H11VXXG0B9D.....	D78	H13413.....	C99
FCMK731-2-2.....	F27			H11VXXH023D.....	D78	H13436.....	C101
FCMK731-4-0.....	F27						
FCMK731-4-2.....	F27						

Part Number Index
Safety Guide
Offer of Sale
Part Number Index, Safety Guide, Offer of Sale



For inventory, lead times, and kit lookup, visit www.pdnplu.com

Model No.	Section / Page No.	Model No.	Section / Page No.	Model No.	Section / Page No.	Model No.	Section / Page No.
H22WXBH2B9000FD	D102	H26WXBBL53D	D103	H2EVXXG0B9D	D79	H32VXBG023D	D91
H22WXBH323000FD	D102	H26WXBCL49D	D102	H2EVXXH023D.....	D79	H32VXBG0B9D.....	D91
H22WXXBL49D.....	D102	H26WXBCL53D	D103	H2EVXXH0B9D	D79	H32VXBH023D	D91
H22WXXBL53D.....	D103	H26WXBG2B9000FD.....	D102	H2EWXBBL49D	D102	H32VXBH0B9D	D91
H22WXXCL49D.....	D102	H26WXBG323000FD	D102	H2EWXBCL53D	D103	H32VXXG023D.....	D91
H22WXXCL53D.....	D103	H26WXBH2B9000FD.....	D102	H2EWXBCL49D	D102	H32VXXG0B9D	D91
H22WXXG2B9000FD	D102	H26WXBH323000FD	D102	H2EWXBCL53D	D103	H32VXXH023D.....	D91
H22WXXG323000FD.....	D102	H26WXXBL49D	D102	H2EWXBG2B9000FD.....	D102	H32VXXH0B9D	D91
H22WXXH2B9000FD	D102	H26WXXBL53D.....	D103	H2EWXBG323000FD	D102	H32WXBBL49D	D113
H22WXXH323000FD.....	D102	H26WXXCL49D.....	D102	H2EWXBH2B9000FD.....	D102	H32WXBBL53D	D114
H24969.....	C99, C100	H26WXXCL53D.....	D103	H2EWXBH323000FD	D102	H32WXBCL49D	D113
H25VXBG023D	D79	H26WXXG2B9000FD	D102	H2EWXXBL49D.....	D102	H32WXBCL53D	D114
H25VXBG0B9D.....	D79	H26WXXG323000FD.....	D102	H2EWXXBL53D.....	D103	H32WXBG2B9000FD.....	D113, D118
H25VXBH023D	D79	H26WXXH2B9000FD	D102	H2EWXXCL49D.....	D102	H32WXBG323000FD	D113
H25VXBH0B9D	D79	H26WXXH323000FD.....	D102	H2EWXXCL53D.....	D103	H32WXBH2B9000FD.....	D113
H25VXXG023D.....	D79	H27VXBG023D	D79	H2EWXXG2B9000FD	D102	H32WXBH323000FD	D113
H25VXXG0B9D	D79	H27VXBG0B9D.....	D79	H2EWXXG323000FD	D102	H32WXXBL49D.....	D113
H25VXXH023D.....	D79	H27VXBH023D	D79	H2EWXXH2B9000FD	D102	H32WXXBL53D.....	D114
H25VXXH0B9D	D79	H27VXBH0B9D	D79	H2EWXXH323000FD.....	D102	H32WXXCL49D.....	D113
H25WXBBL49D	D102	H27VXXG023D.....	D79	H31VXBG023D	D91	H32WXXCL53D.....	D114
H25WXBBL53D	D103	H27VXXG0B9D	D79	H31VXBG0B9D	D91	H32WXXG2B9000FD	D113, D118
H25WXBCL49D	D102	H27VXXH023D.....	D79	H31VXBH023D	D91	H32WXXG323000FD.....	D113
H25WXBCL53D	D103	H27VXXH0B9D	D79	H31VXBH0B9D	D91	H32WXXH2B9000FD	D113
H25WXBG2B9000FD.....	D102	H27WXBBL49D	D102	H31VXXG023D.....	D91	H32WXXH323000FD.....	D113
H25WXBG323000FD	D102	H27WXBBL53D	D103	H31VXXG0B9D	D91	H35VXBG023D	D91
H25WXBH2B9000FD.....	D102	H27WXBCL49D	D102	H31VXXH023D.....	D91	H35VXBG0B9D	D91
H25WXBH323000FD	D102	H27WXBCL53D	D103	H31VXXH0B9D	D91	H35VXBH023D	D91
H25WXXBL49D.....	D102	H27WXBG2B9000FD.....	D102	H31WXBBL49D	D113	H35VXBH0B9D	D91
H25WXXBL53D.....	D103	H27WXBG323000FD	D102	H31WXBCL49D	D113	H35VXXG023D.....	D91
H25WXXCL49D.....	D102	H27WXBH2B9000FD.....	D102	H31WXBCL53D	D114	H35VXXG0B9D	D91
H25WXXCL53D.....	D103	H27WXBH323000FD	D102	H31WXBCL53D	D114	H35VXXH023D.....	D91
H25WXXG2B9000FD	D102	H27WXXBL49D	D102	H31WXBG2B9000FD.....	D113, D118	H35VXXH0B9D	D91
H25WXXG323000FD.....	D102	H27WXXBL53D.....	D103	H31WXBG323000FD	D113	H35WXBBL49D	D113
H25WXXH2B9000FD	D102	H27WXXCL49D.....	D102	H31WXBH2B9000FD.....	D113	H35WXBBL53D	D114
H25WXXH323000FD.....	D102	H27WXXCL53D.....	D103	H31WXBH323000FD	D113	H35WXBCL49D	D113
H26VXBG023D	D79	H27WXXG2B9000FD	D102	H31WXBH323000FD	D113	H35WXBCL53D	D114
H26VXBG0B9D.....	D79	H27WXXG323000FD.....	D102	H31WXXBL49D.....	D113	H35WXBG2B9000FD.....	D113
H26VXBH023D	D79	H27WXXH2B9000FD	D102	H31WXXBL53D.....	D114	H35WXBG323000FD	D113
H26VXBH0B9D	D79	H27WXXH323000FD.....	D102	H31WXXCL49D.....	D113	H35WXBH2B9000FD	D113
H26VXXG023D.....	D79	H2EVXBG023D	D79	H31WXXCL53D.....	D114	H35WXBH323000FD	D113
H26VXXG0B9D	D79	H2EVXBG0B9D.....	D79	H31WXXG2B9000FD	D113	H35WXXBL49D.....	D113
H26VXXH023D.....	D79	H2EVXBH023D	D79	H31WXXG323000FD.....	D113	H35WXXBL53D.....	D114
H26VXXH0B9D	D79	H2EVXBH0B9D.....	D79	H31WXXH2B9000FD	D113	H35WXXCL49D.....	D113
H26WXBBL49D	D102	H2EVXBH0B9D.....	D79	H31WXXH323000FD.....	D113		
		H2EVXXG023D	D79				

Part Number Index
Safety Guide
Offer of Sale
Part Number Index, Safety Guide, Offer of Sale



For inventory, lead times, and kit lookup, visit www.pdnplu.com

Model No.	Section / Page No.	Model No.	Section / Page No.	Model No.	Section / Page No.	Model No.	Section / Page No.
H35WXXCL53D.....	D114	H37WXBH323000FD	D113	HA1WXLG2G9000FA	D99	HA7VXLG0G9A.....	D77
H35WXXG2B9000FD	D113	H37WXXBL49D.....	D113	HA1WXLH2G9000FA	D99	HA7VXLH023A.....	D77
H35WXXG323000FD.....	D113	H37WXXBL53D.....	D114	HA2VXBG023A	D77	HA7VXLH0G9A	D77
H35WXXH2B9000FD	D113	H37WXXCL49D.....	D113	HA2VXBG0G9A.....	D77	HA7WXBG2G9000FA.....	D99
H35WXXH323000FD.....	D113	H37WXXCL53D.....	D114	HA2VXBH023A	D77	HA7WXBH2G9000FA.....	D99
H36VXBG023D	D91	H37WXXG2B9000FD	D113	HA2VXBH0G9A.....	D77	HA7WXLG2G9000FA	D99
H36VXBG0B9D	D91	H37WXXG323000FD.....	D113	HA2VXLG023A.....	D77	HA7WXLH2G9000FA	D99
H36VXBH023D	D91	H37WXXH2B9000FD	D113	HA2VXLG0G9A	D77	HAEVXBG023A	D77
H36VXBH0B9D	D91	H37WXXH323000FD.....	D113	HA2VXLH023A.....	D77	HAEVXBG0G9A	D77
H36VXXG023D.....	D91	H3EVXBG023D	D91	HA2VXLH0G9A	D77	HAEVXBH023A	D77
H36VXXG0B9D	D91	H3EVXBG0B9D.....	D91	HA2WXBG2G9000FA.....	D99, D111	HAEVXBH0G9A.....	D77
H36VXXH023D.....	D91	H3EVXBH023D	D91	HA2WXBH2G9000FA.....	D99	HAEVXLG023A.....	D77
H36VXXH0B9D	D91	H3EVXBH0B9D	D91	HA2WXLG2G9000FA	D99	HAEVXLG0G9A.....	D77
H36WXBBL49D	D113	H3EVXXG023D	D91	HA2WXLH2G9000FA	D99	HAEVXLH023A.....	D77
H36WXBBL53D	D114	H3EVXXG0B9D	D91	HA2WXLH2G9000FA	D99	HAEVXLH0G9A	D77
H36WXBCL49D	D113	H3EVXXH023D.....	D91	HA5VXBG023A	D77	HAEWXBG2G9000FA.....	D99
H36WXBCL53D	D114	H3EVXXH0B9D	D91	HA5VXBG0G9A.....	D77	HAEWXBH2G9000FA.....	D99
H36WXBG2B9000FD.....	D113	H3EWXBBL49D	D113	HA5VXBH023A	D77	HAEWXLG2G9000FA	D99
H36WXBG323000FD	D113	H3EWXBBL53D	D114	HA5VXBH0G9A.....	D77	HAEWXLH2G9000FA	D99
H36WXBH2B9000FD	D113	H3EWXBCL49D	D113	HA5VXLG023A.....	D77	HB1VXBG023A	D76
H36WXBH323000FD	D113	H3EWXBCL53D	D114	HA5VXLG0G9A	D77	HB1VXBG0G9A	D76
H36WXXBL49D.....	D113	H3EWXBG2B9000FD.....	D113	HA5VXLH023A.....	D77	HB1VXBH023A	D76
H36WXXBL53D.....	D114	H3EWXBG323000FD	D113	HA5VXLH0G9A	D77	HB1VXBH0G9A.....	D76
H36WXXCL49D.....	D113	H3EWXBH2B9000FD.....	D113	HA5VXLG023A.....	D77	HB1VXLG023A.....	D76
H36WXXCL53D.....	D114	H3EWXBH323000FD	D113	HA5VXLG0G9A	D77	HB1VXLG0G9A.....	D76
H36WXXG2B9000FD	D113	H3EWXXBL49D.....	D113	HA5WXBG2G9000FA.....	D99	HB1VXLH023A.....	D76
H36WXXG323000FD.....	D113	H3EWXXBL53D.....	D114	HA5WXBH2G9000FA.....	D99	HB1VXLH0G9A	D76
H36WXXH2B9000FD	D113	H3EWXXCL49D.....	D113	HA5WXLG2G9000FA	D99	HB1VXLH023A.....	D76
H36WXXH323000FD.....	D113	H3EWXXCL53D.....	D114	HA5WXLH2G9000FA	D99	HB1VXLH0G9A	D76
H37VXBG023D	D91	H3EWXXG2B9000FD	D113	HA6VXBG023A	D77	HB1WXBG2G9000FA.....	D98
H37VXBG0B9D	D91	H3EWXXG323000FD	D113	HA6VXBH023A	D77	HB1WXLG2G9000FA	D98
H37VXBH023D	D91	H3EWXXH2B9000FD	D113	HA6VXBH0G9A.....	D77	HB1WXLH2G9000FA	D98
H37VXBH0B9D	D91	H3EWXXH323000FD.....	D113	HA6VXLG023A.....	D77	HB2VXBG023A	D76
H37VXXG023D.....	D91	HA1VXBG023A	D77	HA6VXLG0G9A	D77	HB2VXBG0G9A	D76
H37VXXG0B9D	D91	HA1VXBG0G9A.....	D77	HA6VXLH023A.....	D77	HB2VXBH023A	D76
H37VXXH023D.....	D91	HA1VXBH023A	D77	HA6VXLH0G9A	D77	HB2VXBH0G9A.....	D76
H37VXXH0B9D	D91	HA1VXBH0G9A.....	D77	HA6WXBG2G9000FA.....	D99	HB2VXLG023A.....	D76
H37WXBBL49D	D113	HA1VXLG023A.....	D77	HA6WXBH2G9000FA.....	D99	HB2VXLG0G9A	D76
H37WXBBL53D	D114	HA1VXLG0G9A	D77	HA6WXLG2G9000FA	D99	HB2VXLH023A.....	D76
H37WXBCL49D	D113	HA1VXLH023A.....	D77	HA6WXLH2G9000FA	D99	HB2VXLH0G9A	D76
H37WXBCL53D	D114	HA1VXLH0G9A	D77	HA7VXBG023A	D77	HB2WXBG2G9000FA.....	D98, D111
H37WXBG2B9000FD.....	D113	HA1VXLH023A.....	D77	HA7VXBG0G9A.....	D77	HB2WXBH2G9000FA.....	D98
H37WXBG323000FD	D113	HA1WXBG2G9000FA.....	D99, D111	HA7VXBH023A	D77	HB2WXLG2G9000FA	D98
H37WXBH2B9000FD.....	D113	HA1WXBH2G9000FA.....	D99	HA7VXBH0G9A.....	D77	HB2WXLG2G9000FA	D98
				HA7VXLG023A.....	D77	HB2WXLH2G9000FA	D98

Part Number Index
 Safety Guide
 Offer of Sale
 Part Number Index,
 Safety Guide, Offer of Sale



For inventory, lead times, and kit lookup, visit www.pdnplu.com

Model No.	Section / Page No.	Model No.	Section / Page No.	Model No.	Section / Page No.	Model No.	Section / Page No.
HB5VXBG023A	D76	HBEWXBG2G9000FA	D98	JJDX35	D255	K053218	C105, C109
HB5VXBG0G9A	D76	HBEWXBH2G9000FA	D98	K			
HB5VXBH023A	D76	HBEWXLG2G9000FA	D98	K012003	C107, C108	K053220	C105, C109
HB5VXBH0G9A	D76	HBEWXLH2G9000FA	D98	K013001	C101	K053221	C106, C110
HB5VXLG023A	D76	HBNVXBG023A	D76	K022090	D278	K06020003	D291
HB5VXLG0G9A	D76	HBNVXBG0G9A	D76	K022091	D278	K062005	C101
HB5VXLH023A	D76	HBNVXBH023A	D76	K022095	D279	K0652035	C99
HB5VXLH0G9A	D76	HBNVXBH0G9A	D76	K022101	D278	K0653035	C99, D290
HB5WXBG2G9000FA	D98	HBNWXBG2G9000FA	D98	K0251035	D290	K0655035	C99, D290
HB5WXBH2G9000FA	D98	HBNWXBH2G9000FA	D98	K0252035	D290	K0656035	C99, D290
HB5WXLG2G9000FA	D98	HBPVXBG023A	D76	K0253035	D290	K0658035	C99, D290
HB5WXLH2G9000FA	D98	HBPVXBG0G9A	D76	K032270	D289	K0659035	C99, D290
HB6VXBG023A	D76	HBPVXBH023A	D76	K043011	D289	K0852025	C99
HB6VXBG0G9A	D76	HBPVXBH0G9A	D76	K043012	D289	K0853025	C99, D290
HB6VXBH023A	D76	HBPWXBG2G9000FA	D98	K0451025	C100, D290	K0855025	C99, D290
HB6VXBH0G9A	D76	HBPWXBH2G9000FA	D98	K0452025	C100, D290	K0856025	C99, D290
HB6VXLG023A	D76	HBCQWXBG2G9000FA	D98	K0453025	C100, D290	K0858025	C99, D290
HB6VXLG0G9A	D76	HM*VX2049A	D13	K053010	C110	K0859025	C99, D290
HB6VXLH023A	D76	HM2VX2049A	D4, D13, D15	K053011	C110	K092020	C105, C106, C109, C110
HB6VXLH0G9A	D76	HM5VX2049A	D4, D13, D17	K053018	C106	K092034	C105, C106, C109, C110
HB6WXBG2G9000FA	D98	HMBVX00XXA	D4, D12	K053019	C106	K092046	C107, C108, C109, C110
HB6WXBH2G9000FA	D98	HMCVX00XXA	D4, D12	K053022	C105, C109	K103035	C105, C106, C109, C110
HB6WXLG2G9000FA	D98	HMDXX1	D34, D38, D42, D54	K053023	C109	K103053	C105, C106, C109, C110
HB6WXLH2G9000FA	D98	HMDXX2	D34, D38, D42, D54	K053025	C105, C109	K103061	C107, C108, C109, C110
HB7VXBG023A	D76	HMEVX2049A	D4, D9, D10, D11, D13, D14	K053026	C105, C109	K112045	C101
HB7VXBG0G9A	D76	HMNVX2049A	D4, D10, D11, D13, D15	K053064	C106, C110	K112046	C101
HB7VXBH023A	D76	HMPVX2049A	D4, D13, D16	K053065	C106, C110	K123018	C109
HB7VXBH0G9A	D76	HMQVX2049A	D4, D13, D16	K053067	C106, C110	K123021	C109
HB7VXLG023A	D76	HV Valve Series	E62	K053069	C106, C110	K123024	C109
HB7VXLG0G9A	D76	HVN4200-8	E62	K053070	C106, C110	K1351045	C101
HB7VXLH023A	D76	HVN4400	E62	K053077	C105, C109	K1355045	C101
HB7VXLH0G9A	D76	HVN4400-10	E62	K053078	C105, C109	K1356045	C101
HB7WXBG2G9000FA	D98	HVN4400-15	E62	K053111	C107, C108, C109	K135804553	C101
HB7WXBH2G9000FA	D98	HVRK420001	E62	K053113	C107, C108, C109	K135904553	C101
HB7WXLG2G9000FA	D98	HVRK440001	E62	K053114	C107, C108, C109	K14213	C100
HB7WXLH2G9000FA	D98	J		K053115	C107, C108	K142230	D278, D279, D302
HBEVXBG023A	D76	JJDX10-A	D255	K053116	C107, C108, C109	K142231	D278, D302
HBEVXBG0G9A	D76	JJDX15-A	D255	K053143	C110	K142270	D278, D302
HBEVXBH023A	D76	JJDX20-A	D255	K053145	C110	K152003	C99, C100, D291
HBEVXBH0G9A	D76	JJDX25-A	D255	K053146	C110	K162001	D291
HBEVXLG023A	D76	JJDX30-A	D255	K053157	C110		
HBEVXLG0G9A	D76			K053159	C110		
HBEVXLH023A	D76						
HBEVXLH0G9A	D76						

Part Number Index
Safety Guide
Offer of Sale
Part Number Index, Safety Guide, Offer of Sale



For inventory, lead times, and kit lookup, visit www.pdnplu.com

Model No.	Section / Page No.	Model No.	Section / Page No.	Model No.	Section / Page No.	Model No.	Section / Page No.
K1753035	D290	K323027	C110	K423006	C99	K593107	C101
K175803553	D290	K343001	C99, C100	K423010	C99	K593108	C101, C102
K175903553	D290	K343002	C99, C100	K423020	C101	K593111	C102
K183001	C99, C100	K343042	C101	K423022	C101	K593112	C101
K183012	C101	K352056	C110	K4520N14060	D288	K593125	D290
K183047	C99	K352064	C101	K4520N14160	D288	K593185	C102
K183049	C105, C106, C109, C110	K352073	C109	K4520N14300	D288	K593254	C102
K183057	C105, C106, C109, C110	K352074	C109	K472001C	D289	K593271	C102
K183058	C107, C108, C109, C110	K352075	C109	K472002C	D289	K593274	D290
K183077	D289	K352076	C105, C106	K472003C	D289	L	
K183082	D289	K352077	C105, C106	K472009C	D289	L55402308C	D285
K183083	D289	K352078	C107	K473010	C101	L55403308C	D285
K183084	D289	K352080	C108	K473011	C101	L55405305C	D287
K183108	C99	K352083	C110	K473014	C105, C106, C109, C110	L55405307C	D286
K1853025	D290	K352124	D291	K473015	C105, C106, C109, C110	L55406307C	D286
K185802553	D290	K352125	D291	K473016	C107, C108, C109, C110	L55407305C	D286
K185902553	D290	K352126	D291	K493002	C105, C106, C109, C110	L55407306C	D286
K202001	C105, C106, C109, C110	K352127	D291	K493009	C105, C106, C109, C110	L55408302C	D285
K202002	C105, C106, C109, C110	K352128	D291	K493009	C105, C106, C109, C110	L55408303C	D285
K212001	C105, C106, C109, C110	K352129	D291	K493016	C107, C108, C109, C110	L55408311C	D285
K212002	C105, C106, C109, C110	K352130	D291	K493016	C107, C108, C109, C110	L55411308C	D285
K21R02012L	D291	K352131	D291	K563015	C105	L55414307C	D286
K21R02025L	D291, E27	K352166	C99, C100	K563016	C106, C110	L55414314C	D287
K21R02037L	D291, E27	K352276	C105, C106	K563017	C105	L6543	D298
K21R02050L	D291, E27	K352277	C105, C106	K563021	C106, C110	L65431102	D278
K21R02075L	D291, E27	K352355	D291	K563027	C110	L6548	D298
K2351035	D290	K352359	D291	K593003	C99, C100, C102	L65481102	D279
K2352035	D290	K352360	D291	K593007	C102	L6553	D296
K2353035	D290	K352362	D291	K593010	C99, C100, C102	L6553810249	D278
K255202549	C100	K352366	C99, C100	K593010	C99, C100, C102	L6553810253	D278
K2553025	C100	K362307	D289	K593014	C99, C100, C102	L6553910249	D278
K272002	C101	K362308	D289	K593014	D290	L6553910253	D278
K272004	C99	K41RB72008	C100	K593025	C99, C100, C102	L6558	D296
K313028	C107, C108, C109, C110	K41RB72009	C100	K593025	D290	L6558810249	D279
K313029	C107, C108, C109, C110	K41RB72011	C99, C100	K593035	C99, C100, C102	L6558810253	D279
K322004	C101	K41RB72121	C105, C106, C109, C110	K593035	D290	L6558910249	D279
K322012	D291	K41RB72143	C107, C108, C109, C110	K593041	C99, C100, C102	L6558910253	D279
K322013	D291	K41RB72210	C106	K593060	D290	L6643	D298
		K41RB72211	C106	K593071	D290	L66431211	D278
		K41RB72221	C105, C106, C109, C110	K593081	D290	L66431221	D278
		K423001	C100	K593094	C102	L66431231	D278
		K423002	C100	K593097	C101, C102	L6648	D298
				K593098	C102	L66481211	D279

Part Number Index
 Safety Guide
 Offer of Sale
 Part Number Index, Safety Guide, Offer of Sale



For inventory, lead times, and kit lookup, visit www.pdnplu.com

Model No.	Section / Page No.	Model No.	Section / Page No.	Model No.	Section / Page No.	Model No.	Section / Page No.
L66481221.....	D279	L68481102.....	D281	L70481102.....	D281	M01931819.....	E24
L66481231.....	D279	L685.....	D299	L705.....	D299	M01934619.....	E24
L6653.....	D297	L6854810249.....	D280	L7054810249.....	D280	M01941819.....	E24
L6653821149.....	D278	L6854810253.....	D280	L7054810253.....	D280	M01944619.....	E24
L6653821153.....	D278	L6854910249.....	D280	L7054910249.....	D280	M01961819.....	E24
L6653822149.....	D278	L6854910253.....	D280	L7054910253.....	D280	M01964619.....	E24
L6653822153.....	D278	L6858810249.....	D281	L7058810249.....	D281	M032*18.....	E27
L6653823149.....	D278	L6858810253.....	D281	L7058810253.....	D281	M032*24.....	E27
L6653823153.....	D278	L6858910249.....	D281	L7058910249.....	D281	M032*46.....	E27
L6653921149.....	D278	L6858910253.....	D281	L7058910253.....	D281	M032*54.....	E27
L6653921153.....	D278	L694.....	D301	LV2N2BSS.....	E51	M03321833.....	E24
L6653922149.....	D278	L69441211.....	D280	LV2N3B.....	E51	M03324633.....	E24
L6653922153.....	D278	L69441221.....	D280	LV3N3B.....	E51	M03331833.....	E24
L6653923149.....	D278	L69441231.....	D280	LV3N4BSS.....	E51	M03334633.....	E24
L6653923153.....	D278	L69481211.....	D281	LV3N6B.....	E51	M03341833.....	E24
L6658.....	D297	L69481221.....	D281	LV4N4BSS.....	E51	M03344633.....	E24
L6658821149.....	D279	L69481231.....	D281	LV4N6B.....	E51	M053003.....	E27
L6658821153.....	D279	L695.....	D300	LV6N6B.....	E51	M053007.....	E27
L6658822149.....	D279	L6954821149.....	D280	LV6N8BSS.....	E51	M053019.....	E27
L6658822153.....	D279	L6954821153.....	D280	LV6NAB.....	E51	M053020.....	E27
L6658823149.....	D279	L6954822149.....	D280	LV8N8BSS.....	E51	M053030.....	E27
L6658823153.....	D279	L6954822153.....	D280	LV8NAB.....	E51	M053033.....	E27
L6658921149.....	D279	L6954823149.....	D280	LVANAB.....	E51	M053038.....	E27
L6658921153.....	D279	L6954823153.....	D280	LVBNAB.....	E51	M053039.....	E27
L6658922149.....	D279	L6954921149.....	D280	LVBNCBSS.....	E51	M05422443.....	E23
L6658922153.....	D279	L6954921153.....	D280	LVCNCB.....	E51	M05422448.....	E23
L6658923149.....	D279	L6954922149.....	D280	LVCNCBSS.....	E51	M05422488.....	E24
L6658923153.....	D279	L6954922153.....	D280			M05425443.....	E23
L6743.....	D297	L6954923149.....	D280		M	M05425448.....	E23
L67431102.....	D278	L6954923153.....	D280	M012001.....	E33	M05425488.....	E24
L6748.....	D297	L6958821149.....	D281	M012002.....	E33	M05432443.....	E23
L67481102.....	D279	L6958821153.....	D281	M012003.....	E33	M05432448.....	E23
L6753.....	D296	L6958822149.....	D281	M012005.....	E33	M05432488.....	E24
L6753810249.....	D278	L6958822153.....	D281	M013005.....	E30	M05435443.....	E23
L6753810253.....	D278	L6958823149.....	D281	M013007.....	E30	M05435448.....	E23
L6753910249.....	D278	L6958823153.....	D281	M013009.....	E30	M05435488.....	E24
L6753910253.....	D278	L6958921149.....	D281	M013011.....	E29	M05442443.....	E23
L6758.....	D296	L6958921153.....	D281	M013012.....	E29	M05442448.....	E23
L6758810249.....	D279	L6958922149.....	D281	M013013.....	E29	M05442488.....	E24
L6758810253.....	D279	L6958922153.....	D281	M013014.....	E29	M05445443.....	E23
L6758910249.....	D279	L6958923149.....	D281	M013015.....	E29	M05445448.....	E23
L6758910253.....	D279	L6958923153.....	D281	M013016.....	E29	M05445488.....	E24
L684.....	D301	L704.....	D300	M013017.....	E29	M05462443.....	E23
L68441102.....	D280	L70441102.....	D280	M01921819.....	E24	M05462448.....	E23
				M01924619.....	E24		

Part Number Index
Safety Guide
Offer of Sale
Part Number Index, Safety Guide, Offer of Sale



For inventory, lead times, and kit lookup, visit www.pdnplu.com

Model No.	Section / Page No.	Model No.	Section / Page No.	Model No.	Section / Page No.	Model No.	Section / Page No.
M05465443.....	E23	M06424651.....	E23	M083008.....	E32	M08561826.....	E24
M05465448.....	E23	M06424659.....	E23	M08421830.....	E24	M08561843.....	E23
M05822451.....	E23	M06431851.....	E23	M08424630.....	E24	M08561848.....	E23
M05825451.....	E23	M06431859.....	E23	M08431830.....	E24	M08561851.....	E23
M05832451.....	E23	M06434651.....	E23	M08434630.....	E24	M08564605.....	E24
M05835451.....	E23	M06434659.....	E23	M08441830.....	E24	M08564626.....	E24
M05842451.....	E23	M06441851.....	E23	M08444630.....	E24	M08564643.....	E23
M05845451.....	E23	M06441859.....	E23	M08521805.....	E24	M08564648.....	E23
M05862451.....	E23	M06444651.....	E23	M08521826.....	E24	M08564651.....	E23
M05865451.....	E23	M06444659.....	E23	M08521843.....	E23	M09521803.....	E24
M062*03.....	E28	M06461851.....	E23	M08521848.....	E23	M09521805.....	E24
M062*05.....	E29	M06461859.....	E23	M08521851.....	E23	M09521843.....	E23
M062*19.....	E30	M06464651.....	E23	M08521888.....	E24	M09524603.....	E24
M062*26.....	E30	M06464659.....	E23	M08524605.....	E24	M09524605.....	E24
M062*30.....	E31	M06521851.....	E23	M08524626.....	E24	M09524643.....	E23
M062*33.....	E31	M06521859.....	E23	M08524643.....	E23	M09531803.....	E24
M062*40.....	E28	M06524651.....	E23	M08524648.....	E23	M09531805.....	E24
M062*43.....	E28	M06524659.....	E23	M08524651.....	E23	M09531843.....	E23
M062*48.....	E29	M06531851.....	E23	M08524688.....	E24	M09534603.....	E24
M062*51.....	E29	M06531859.....	E23	M08531805.....	E24	M09534605.....	E24
M062*54.....	E33	M06534651.....	E23	M08531826.....	E24	M09534643.....	E23
M062*59.....	E29	M06534659.....	E23	M08531843.....	E23	M09541803.....	E24
M062*62.....	E32	M06541851.....	E23	M08531848.....	E23	M09541805.....	E24
M062*63.....	E32	M06541859.....	E23	M08531851.....	E23	M09541843.....	E23
M062*64.....	E32	M06544651.....	E23	M08531888.....	E24	M09544603.....	E24
M062*65.....	E32	M06544659.....	E23	M08534605.....	E24	M09544605.....	E24
M062*74.....	E32	M06561851.....	E23	M08534626.....	E24	M09544643.....	E23
M062*78.....	E32	M06561859.....	E23	M08534643.....	E23	M09561803.....	E24
M062*84.....	E33	M06564651.....	E23	M08534648.....	E23	M09561805.....	E24
M062*85.....	E33	M06564659.....	E23	M08534651.....	E23	M09561843.....	E23
M062*88.....	E28	M073006.....	E33	M08534688.....	E24	M09564603.....	E24
M062*95.....	E32	M073009.....	E28	M08541805.....	E24	M09564605.....	E24
M062*96.....	E32	M073016... E29, E30, E32, E33		M08541826.....	E24	M09564643.....	E23
M062*97.....	E32	M073017.....	E33	M08541843.....	E23	M09621805.....	E24
M062*98.....	E32	M073022.....	E28	M08541848.....	E23	M09621843.....	E23
M062*99.....	E29	M073026... E29, E30, E32, E33		M08541851.....	E23	M09624605.....	E24
M06221840.....	E24	M073028.....	E33	M08541888.....	E24	M09624643.....	E23
M06224640.....	E24	M073033.....	E28	M08544605.....	E24	M09631805.....	E24
M06231840.....	E24	M073037... E29, E30, E32, E33		M08544626.....	E24	M09631843.....	E23
M06234640.....	E24	M073042.....	E28	M08544643.....	E23	M09634605.....	E24
M06241840.....	E24	M073046... E29, E30, E32, E33		M08544648.....	E23	M09634643.....	E23
M06244640.....	E24	M083003.....	E32	M08544651.....	E23	M09641805.....	E24
M06421851.....	E23	M083004.....	E32	M08544688.....	E24	M09641843.....	E23
M06421859.....	E23	M083005.....	E32	M08561805.....	E24	M09644605.....	E24

Part Number Index
 Safety Guide
 Offer of Sale
 Part Number Index,
 Safety Guide, Offer of Sale



For inventory, lead times, and kit lookup, visit www.pdnplu.com

Model No.	Section / Page No.	Model No.	Section / Page No.	Model No.	Section / Page No.	Model No.	Section / Page No.
M09644643.....	E23	M193005.....	E31	M323007.....	E28	M493008.....	E32
M09661805.....	E24	M232001.....	E26	M333013.....	E28, E29	M493009.....	E31
M09661843.....	E23	M232002.....	E26	M333014.....	E28	M493010.....	E31
M09664605.....	E24	M232003.....	E26	M333016.....	E28	M493011.....	E32
M09664643.....	E23	M232004.....	E26	M343018.....	E30	M493012.....	E32
M09721848.....	E23	M232005.....	E26	M343019.....	E30	M493014.....	E32
M09724648.....	E23	M232006.....	E26	M343022.....	E30	M493015.....	E30
M09731848.....	E23	M242001.....	E27	M343027.....	E30	M493020.....	E30
M09734648.....	E23	M242002.....	E27	M343028.....	E30	M493022.....	E31
M09741848.....	E23	M242003.....	E27	M343032.....	E31	M493023.....	E31
M09744648.....	E23	M242004.....	E27	M343038.....	E31	M493024.....	E31
M09761848.....	E23	M242006.....	E27	M343039.....	E31	M493026.....	E32
M09764648.....	E23	M242007.....	E27	M363002.....	E30	M493027.....	E32
M09821848.....	E23	M242008.....	E27	M373014.....	E27	M493037.....	E32
M09824648.....	E23	M242009.....	E27	M373020.....	E27	M493038.....	E32
M09831848.....	E23	M242011.....	E27	M373033.....	E27	M523009.....	E32
M09834648.....	E23	M242012.....	E27	M373039.....	E27	M523010.....	E32
M09841848.....	E23	M242013.....	E27	M373060.....	E27	M523011.....	E32
M09844648.....	E23	M242014.....	E27	M373064.....	E27	M553004.....	E28
M09861848.....	E23	M243008.....	E32	M373074.....	E27	M553005.....	E28
M09864648.....	E23	M243019.....	E32	M373076.....	E27	M563002.....	E32, E33
M103012.....	E28, E29, E31, E33	M243027.....	E32	M373102.....	E27	M563006.....	E32, E33
M103047.....	E28, E29, E31, E33	M243028.....	E30	M373103.....	E27	M563007.....	E32
M103066.....	E28, E29, E31, E33	M243032.....	E32	M373116.....	E27	M563008.....	E32
M103108.....	E28, E29, E31, E33	M243036.....	E30	M373118.....	E27	M563009.....	E32
M103111.....	E32, E33	M243043.....	E32	M373142.....	E27	M563014.....	E32, E33
M103112.....	E32, E33	M243044.....	E32	M373146.....	E27	M563016.....	E32
M103113.....	E32, E33	M243045.....	E32	M373156.....	E27	M573001.....	E31
M103114.....	E32, E33	M273002.....	E28	M383007.....	E30	M573003.....	E31
M122001.....	E27	M273006.....	E28	M383011.....	E30	M573004.....	E31
M122002.....	E27	M273007.....	E28	M383018.....	E30	M573011.....	E31
M122003.....	E27	M273022.....	E28	M383029.....	E30	MCS10A05PDL.....	C84
M122004.....	E27	M273023.....	E28	M383032.....	E32	MFSA05DB.....	C87
M122005.....	E27	M273024.....	E28	M383033.....	E32	MFSA12DB.....	C87
M122006.....	E27	M303005.....	E29	M383034.....	E32	MFUA05DB.....	C87
M133003.....	E28, E29	M303006.....	E29	M413015.....	E32	MFUA12DB.....	C87
M133012.....	E28, E29	M303007.....	E29	M413016.....	E32	MMCS††A05FM5.....	C83
M133018.....	E28, E29	M303008.....	E29	M413017.....	E32	MMCS††A12FF1.....	C83
M163005.....	E31	M313004.....	E27	M423002.....	E31	MMCU††A05F.....	C83
M163012.....	E31	M313011.....	E27	M423004.....	E31	MMCU††A12F.....	C83
M193002.....	E31	M313013.....	E27	M443002.....	E28	MMDVA1.....	D34, D38, D42, D54
		M313017.....	E27	M443003.....	E28	MMDVA2.....	D34, D38, D42, D54, D61
		M323005.....	E28	M493006.....	E32	MMFS##A05FM5.....	C83
		M323006.....	E28	M493007.....	E32		

Part Number Index
Safety Guide
Offer of Sale
Part Number Index, Safety Guide, Offer of Sale



For inventory, lead times, and kit lookup, visit www.pdnplu.com

Model No.	Section / Page No.	Model No.	Section / Page No.	Model No.	Section / Page No.	Model No.	Section / Page No.
MMFS##A12FF1	C83	N3659904753	C97	P2LAX391ESHDDDB47	C16	P2LAX691111	E15
MMFS6A00M3	C85	N37431091	C98	P2LAX391ESHDDDB48	C16	P2LAX69122	E15
MMFU##A05F	C83	N37441091	C98	P2LAX391ESHDDG47	C16	P2LAX691EEHDDDB47	C17
MMFU##A12F	C83	N37461091	C98	P2LAX391ESHDDG48	C16	P2LAX691EEHDDDB48	C17
MMFU**A**F	C83	N37471091	C98	P2LAX391ESNDD7B9	C12	P2LAX691EEHDDG47	C17
N		N3753904549	C95	P2LAX391ESNDDDB49	C12	P2LAX691EEHDDG48	C17
N1641001	F15	N3753904553	C95	P2LAX391ESNDDDB53	C12	P2LAX691EENDD7B9	C15
N1642003	F15	N3754904549	C95	P2LAX391ESNDDG49	C12	P2LAX691EENDDDB49	C15
N1643003	F15	N3754904553	C95	P2LAX391ESNDDG53	C12	P2LAX691EENDDDB53	C15
N31431091	C98	N3756904549	C95	P2LAX391ESNXB549	C12	P2LAX691EENDDG49	C15
N31441091	C98	N3756904553	C95	P2LAX391ESNXB553	C12	P2LAX691EENDDG53	C15
N31461091	C98	N3757904549	C95	P2LAX391PS	C19	P2LAX691EENXB549	C15
N31471091	C98	N3757904553	C95	P2LAX391VS	E15	P2LAX691EENXB553	C15
N3153904549	C95	N38471091	C98	P2LAX391VV	E15	P2LAX691PP	C19
N3153904553	C95	N38481091	C98	P2LAX511VS	E15	P2LAX81111	E15
N3154904549	C95	N38491091	C98	P2LAX511VV	E15	P2LAX81122	E15
N3154904553	C95	N3857904753	C97	P2LAX591EEHDDDB47	C17	P2LAX891111	E15
N3156904549	C95	N3858904753	C97	P2LAX591EEHDDDB48	C17	P2LAX89122	E15
N3156904553	C95	N3859904753	C97	P2LAX591EEHDDG47	C17	P2LAX891EEHDDDB47	C17
N3157904549	C95	P		P2LAX591EEHDDG48	C17	P2LAX891EEHDDDB48	C17
N3157904553	C95	P01698	D288	P2LAX591EENDD7B9	C14	P2LAX891EEHDDG47	C17
N32471091	C98	P04062	D288	P2LAX591EENDDDB49	C14	P2LAX891EEHDDG48	C17
N32481091	C98	P04063	D288	P2LAX591EENDDDB53	C14	P2LAX891EENDD7B9	C15
N32491091	C98	P0566202	D12	P2LAX591EENDDG49	C14	P2LAX891EENDDDB49	C15
N3257904753	C97	P0568800	D9	P2LAX591EENDDG53	C14	P2LAX891EENDDDB53	C15
N3258904753	C97	P2D2W3226C5	D59	P2LAX591EENXB549	C14	P2LAX891EENDDG49	C15
N3259904753	C97	P2D8V32C5	D59	P2LAX591EENXB553	C14	P2LAX891EENDDG53	C15
N35431091	C98	P2FA22-15	C26	P2LAX591ESHDDDB47	C16	P2LAX891EENXB549	C15
N35441091	C98	P2FCA442	D133, D257	P2LAX591ESHDDDB48	C16	P2LAX891EENXB553	C15
N35461091	C98	P2FCA445	D133, D257	P2LAX591ESHDDG47	C16	P2LAX891PP	C19
N35471091	C98	P2FCA449	D133, D257	P2LAX591ESHDDG48	C16	P2LAXBXSK1	C29
N3553904549	C95	P2FCA453	D133, D257	P2LAX591ESNDD7B9	C13	P2LAXGAXG##NP	C21
N3553904553	C95	P2FCA457	D133, D257	P2LAX591ESNDDDB49	C13	P2LAXGAXN##NP	C21
N3554904549	C95	P2FCB449	C6	P2LAX591ESNDDDB53	C13	P2LAXK20P	C21
N3554904553	C95	P2FCB453	C6	P2LAX591ESNDDG49	C13	P2LAXK84P	C21
N3556904549	C95	P2FCT446	C22	P2LAX591ESNDDG53	C13	P2LAXK87P	C21
N3556904553	C95	P2FCV446	C22	P2LAX591ESNXB549	C13	P2LAXMAXG##NP	C21
N3557904549	C95	P2FP13N4C	C68	P2LAX591ESNXB553	C13	P2LAXMAXN##NP	C21
N3557904553	C95	P2FP13N4D	C68	P2LAX591PP	C19	P2LAXSK1	C29
N36471091	C98	P2FP1P	C6	P2LAX591PS	C19	P2LAXSK2	C29
N36481091	C98	P2FS13N1AE49	C64	P2LAX591VS	E15	P2LAZ311EENDBB49	C3
N36491091	C98	P2LAX	C30, C31	P2LAX591VV	E15	P2LAZ311EENDBB53	C3
N3657904753	C97	P2LAX311VS	E15	P2LAX61111	E15	P2LAZ311ESNDBB49	C3
N3658904753	C97	P2LAX311VV	E15	P2LAX61122	E15	P2LAZ311ESNDBB53	C3

Part Number Index
 Safety Guide
 Offer of Sale
 Part Number Index, Safety Guide, Offer of Sale



For inventory, lead times, and kit lookup, visit www.pdnplu.com

Model No.	Section / Page No.	Model No.	Section / Page No.	Model No.	Section / Page No.	Model No.	Section / Page No.
P2LAZ391EENDBB49.....	C3	P2LBX392VS.....	E15	P2LBX692EEHDDG48.....	C17	P2LBZ512ESNDBB53.....	C3
P2LAZ391EENDBB53.....	C3	P2LBX392VV.....	E15	P2LBX692EEND7B9.....	C15	P2LBZ592EENDBB49.....	C3
P2LAZ391ESNDBB49.....	C3	P2LBX512JJ.....	E16	P2LBX692EENDDB49.....	C15	P2LBZ592EENDBB53.....	C3
P2LAZ391ESNDBB53.....	C3	P2LBX512VS.....	E15	P2LBX692EENDDB53.....	C15	P2LBZ592ESNDBB49.....	C3
P2LAZ391PS.....	C5	P2LBX512VV.....	E15	P2LBX692EENDDG49.....	C15	P2LBZ592ESNDBB53.....	C3
P2LAZ511EENDBB49.....	C3	P2LBX512ZS.....	E16	P2LBX692EENDDG53.....	C15	P2LBZ592PP.....	C5
P2LAZ511EENDBB53.....	C3	P2LBX512ZZ.....	E16	P2LBX692EENXB549.....	C15	P2LBZ592PS.....	C5
P2LAZ511ESNDBB49.....	C3	P2LBX592EEHDD47.....	C17	P2LBX692EENXB553.....	C15	P2LBZ612EENDBB49.....	C3
P2LAZ511ESNDBB53.....	C3	P2LBX592EEHDD48.....	C17	P2LBX81211.....	E15	P2LBZ612EENDBB53.....	C3
P2LAZ591EENDBB49.....	C3	P2LBX592EEHDDG47.....	C17	P2LBX81222.....	E15	P2LBZ692EENDBB49.....	C3
P2LAZ591EENDBB53.....	C3	P2LBX592EEHDDG48.....	C17	P2LBX89211.....	E15	P2LBZ692EENDBB53.....	C3
P2LAZ591ESNDBB49.....	C3	P2LBX592EEND7B9.....	C14	P2LBX89222.....	E15	P2LBZ712EENDBB49.....	C4
P2LAZ591ESNDBB53.....	C3	P2LBX592EENDDB49.....	C14	P2LBX892EEHDD47.....	C17	P2LBZ712EENDBB53.....	C4
P2LAZ591PP.....	C5	P2LBX592EENDDB53.....	C14	P2LBX892EEHDD48.....	C17	P2LBZ792EENDBB49.....	C4
P2LAZ591PS.....	C5	P2LBX592EENDDG49.....	C14	P2LBX892EEHDDG47.....	C17	P2LBZ792EENDBB53.....	C4
P2LAZ611EENDBB49.....	C3	P2LBX592EENDDG53.....	C14	P2LBX892EEHDDG48.....	C17	P2LBZ812EENDBB49.....	C4
P2LAZ611EENDBB53.....	C3	P2LBX592EENXB549.....	C14	P2LBX892EEND7B9.....	C15	P2LBZ812EENDBB53.....	C4
P2LAZ691EENDBB49.....	C3	P2LBX592EENXB553.....	C14	P2LBX892EENDDB49.....	C15	P2LBZ892EENDBB49.....	C4
P2LAZ691EENDBB53.....	C3	P2LBX592ESHDD47.....	C16	P2LBX892EENDDB53.....	C15	P2LBZ892EENDBB53.....	C4
P2LAZ711EENDBB49.....	C4	P2LBX592ESHDD48.....	C16	P2LBX892EENDDG49.....	C15	P2LCX.....	C35, C36
P2LAZ711EENDBB53.....	C4	P2LBX592ESHDDG47.....	C16	P2LBX892EENDDG53.....	C15	P2LCX313VS.....	E15
P2LAZ791EENDBB49.....	C4	P2LBX592ESHDDG48.....	C16	P2LBX892EENXB549.....	C15	P2LCX313VV.....	E15
P2LAZ791EENDBB53.....	C4	P2LBX592ESNDD7B9.....	C13	P2LBX892EENXB553.....	C15	P2LCX393ESHDD47.....	C16
P2LAZ811EENDBB49.....	C4	P2LBX592ESNDD49.....	C13	P2LBX892PP.....	C19	P2LCX393ESHDD48.....	C16
P2LAZ811EENDBB53.....	C4	P2LBX592ESNDD53.....	C13	P2LBXGAXG##NP.....	C21	P2LCX393ESHDDG47.....	C16
P2LAZ891EENDBB49.....	C4	P2LBX592ESNDDG49.....	C13	P2LBXGAXN##NP.....	C21	P2LCX393ESHDDG48.....	C16
P2LAZ891EENDBB53.....	C4	P2LBX592ESNDDG53.....	C13	P2LBXK20P.....	C21	P2LCX393ESNDD7B9.....	C12
P2LBX.....	C32, C33, C34	P2LBX592ESNXB549.....	C13	P2LBXK84P.....	C21	P2LCX393ESNDD49.....	C12
P2LBX312JJ.....	E16	P2LBX592ESNXB553.....	C13	P2LBXK87P.....	C21	P2LCX393ESNDD53.....	C12
P2LBX312VS.....	E15	P2LBX592JJ.....	E16	P2LBXMAXG##NP.....	C21	P2LCX393ESNDDG49.....	C12
P2LBX312VV.....	E15	P2LBX592PP.....	C19	P2LBXMAXN##NP.....	C21	P2LCX393ESNDDG53.....	C12
P2LBX392ESHDD47.....	C16	P2LBX592PS.....	C19	P2LBXSK1.....	C29	P2LCX393ESNXB549.....	C12
P2LBX392ESHDD48.....	C16	P2LBX592VS.....	E15	P2LBZ312EENDBB49.....	C3	P2LCX393ESNXB553.....	C12
P2LBX392ESHDDG47.....	C16	P2LBX592VV.....	E15	P2LBZ312EENDBB53.....	C3	P2LCX393PS.....	C19
P2LBX392ESHDDG48.....	C16	P2LBX592ZS.....	E16	P2LBZ312ESNDBB49.....	C3	P2LCX393VS.....	E15
P2LBX392ESNDD7B9.....	C12	P2LBX592ZZ.....	E16	P2LBZ312ESNDBB53.....	C3	P2LCX393VV.....	E15
P2LBX392ESNDD49.....	C12	P2LBX61211.....	E15	P2LBZ392EENDBB49.....	C3	P2LCX513VS.....	E15
P2LBX392ESNDD53.....	C12	P2LBX61222.....	E15	P2LBZ392EENDBB53.....	C3	P2LCX513VV.....	E15
P2LBX392ESNDDG49.....	C12	P2LBX69*PP.....	C19	P2LBZ392ESNDBB49.....	C3	P2LCX593EEHDD47.....	C17
P2LBX392ESNDDG53.....	C12	P2LBX69211.....	E15	P2LBZ392ESNDBB53.....	C3	P2LCX593EEHDD48.....	C17
P2LBX392ESNXB549.....	C12	P2LBX69222.....	E15	P2LBZ392PS.....	C5	P2LCX593EEHDDG47.....	C17
P2LBX392ESNXB553.....	C12	P2LBX692EEHDD47.....	C17	P2LBZ512EENDBB49.....	C3	P2LCX593EEHDDG48.....	C17
P2LBX392JJ.....	E16	P2LBX692EEHDD48.....	C17	P2LBZ512EENDBB53.....	C3	P2LCX593EEND7B9.....	C14
P2LBX392PS.....	C19	P2LBX692EEHDDG47.....	C17	P2LBZ512ESNDBB49.....	C3	P2LCX593EENDDB49.....	C14

Part Number Index
Safety Guide
Offer of Sale
Part Number Index, Safety Guide, Offer of Sale



For inventory, lead times, and kit lookup, visit www.pdnplu.com

Model No.	Section / Page No.	Model No.	Section / Page No.	Model No.	Section / Page No.	Model No.	Section / Page No.
P2LCX593EENDDB53.....	C14	P2LCX893EENDDB7B9.....	C15	P2LDX314VS	E15	P2LDX61411.....	E15
P2LCX593EENDDG49	C14	P2LCX893EENDDB49.....	C15	P2LDX314V.....	E15	P2LDX61422.....	E15
P2LCX593EENDDG53	C14	P2LCX893EENDDG49	C15	P2LDX394ESHDDDB47.....	C16	P2LDX69411.....	E15
P2LCX593EENXB549	C14	P2LCX893EENDDG53	C15	P2LDX394ESHDDDB48.....	C16	P2LDX69422.....	E15
P2LCX593EENXB553	C14	P2LCX893EENXB549	C15	P2LDX394ESHDDG47	C16	P2LDX694EEHDDDB47.....	C17
P2LCX593ESHDDDB47	C16	P2LCX893EENXB553	C15	P2LDX394ESHDDG48	C16	P2LDX694EEHDDDB48.....	C17
P2LCX593ESHDDDB48	C16	P2LCX893PP	C19	P2LDX394ESNDD7B9.....	C12	P2LDX694EEHDDG47	C17
P2LCX593ESHDDG47	C16	P2LCXDXSK1.....	C29	P2LDX394ESNDDDB49.....	C12	P2LDX694EEHDDG48	C17
P2LCX593ESHDDG48	C16	P2LCXK20P	C21	P2LDX394ESNDDDB53.....	C12	P2LDX694EENDD7B9.....	C15
P2LCX593ESNDD7B9	C13	P2LCXK87P	C21	P2LDX394ESNDDG49	C12	P2LDX694EENDDDB49.....	C15
P2LCX593ESNDDDB49	C13	P2LCXMAXG##NP	C21	P2LDX394ESNDDG53	C12	P2LDX694EENDDDB53.....	C15
P2LCX593ESNDDDB53	C13	P2LCXMAXN##NP	C21	P2LDX394ESNXB549	C12	P2LDX694EENDDG49	C15
P2LCX593ESNDDG49	C13	P2LCZ313EENDBB49.....	C3	P2LDX394ESNXB553	C12	P2LDX694EENDDG53	C15
P2LCX593ESNDDG53	C13	P2LCZ313EENDBB53.....	C3	P2LDX394PS	C19	P2LDX694EENXB549.....	C15
P2LCX593ESNXB549	C13	P2LCZ313ESNDBB49.....	C3	P2LDX394VS	E15	P2LDX694EENXB553.....	C15
P2LCX593ESNXB553	C13	P2LCZ313ESNDBB53.....	C3	P2LDX394V.....	E15	P2LDX694PP	C19
P2LCX593PP	C19	P2LCZ393EENDBB49.....	C3	P2LDX514VS	E15	P2LDX81411.....	E15
P2LCX593PS	C19	P2LCZ393EENDBB53.....	C3	P2LDX514V.....	E15	P2LDX81422.....	E15
P2LCX593VS	E15	P2LCZ393ESNDBB49.....	C3	P2LDX594EEHDDDB47.....	C17	P2LDX89411.....	E15
P2LCX593VV	E15	P2LCZ393ESNDBB53.....	C3	P2LDX594EEHDDDB48.....	C17	P2LDX89422.....	E15
P2LCX61311.....	E15	P2LCZ393PS	C5	P2LDX594EEHDDG47	C17	P2LDX894EEHDDDB47.....	C17
P2LCX61322.....	E15	P2LCZ513EENDBB49.....	C3	P2LDX594EEHDDG48	C17	P2LDX894EEHDDDB48.....	C17
P2LCX69311.....	E15	P2LCZ513EENDBB53.....	C3	P2LDX594EENDD7B9.....	C14	P2LDX894EEHDDG47	C17
P2LCX69322.....	E15	P2LCZ513ESNDBB49.....	C3	P2LDX594EENDDDB49.....	C14	P2LDX894EEHDDG48	C17
P2LCX693EEHDDDB47.....	C17	P2LCZ513ESNDBB53.....	C3	P2LDX594EENDDDB53.....	C14	P2LDX894EENDD7B9.....	C15
P2LCX693EEHDDDB48.....	C17	P2LCZ593EENDBB49.....	C3	P2LDX594EENDDG49	C14	P2LDX894EENDDDB49.....	C15
P2LCX693EEHDDG47	C17	P2LCZ593EENDBB53.....	C3	P2LDX594EENDDG53	C14	P2LDX894EENDDDB53.....	C15
P2LCX693EEHDDG48	C17	P2LCZ593ESNDBB49.....	C3	P2LDX594EENXB549.....	C14	P2LDX894EENDDG49	C15
P2LCX693EENDD7B9.....	C15	P2LCZ593ESNDBB53.....	C3	P2LDX594EENXB553.....	C14	P2LDX894EENDDG53	C15
P2LCX693EENDDDB49.....	C15	P2LCZ593PP	C5	P2LDX594ESHDDDB47.....	C16	P2LDX894EENXB549.....	C15
P2LCX693EENDDDB53.....	C15	P2LCZ593PS	C5	P2LDX594ESHDDDB48.....	C16	P2LDX894EENXB553.....	C15
P2LCX693EENDDG49	C15	P2LCZ613EENDBB49.....	C3	P2LDX594ESHDDG47	C16	P2LDX894PP	C19
P2LCX693EENDDG53	C15	P2LCZ613EENDBB53.....	C3	P2LDX594ESHDDG48	C16	P2M1K0GL	D54
P2LCX693EENXB549	C15	P2LCZ693EENDBB49.....	C3	P2LDX594ESNDD7B9.....	C13	P2M1K0GN.....	D54
P2LCX693EENXB553	C15	P2LCZ693EENDBB53.....	C3	P2LDX594ESNDDDB49.....	C13	P2M1K0GT	D54
P2LCX693PP	C19	P2LCZ713EENDBB49.....	C4	P2LDX594ESNDDDB53.....	C13	P2M1K0TASD	D38, D42
P2LCX81311.....	E15	P2LCZ713EENDBB53.....	C4	P2LDX594ESNDDG49	C13	P2M1PXCA	D55
P2LCX81322.....	E15	P2LCZ793EENDBB49.....	C4	P2LDX594ESNDDG53	C13	P2M1PXFA.....	D55, D56
P2LCX89311.....	E15	P2LCZ793EENDCB53.....	C4	P2LDX594ESNXB549	C13	P2M1PXFAF7F7	D56
P2LCX89322.....	E15	P2LCZ813EENDBB49.....	C4	P2LDX594ESNXB553	C13	P2M1PXSG	D54, D56
P2LCX893EEHDDDB47.....	C17	P2LCZ813EENDBB53.....	C4	P2LDX594PP	C19	P2M1PXSGF7F7	D56
P2LCX893EEHDDDB48.....	C17	P2LCZ893EENDBB49.....	C4	P2LDX594PS	C19	P2M1PXSL.....	D54
P2LCX893EEHDDG47	C17	P2LCZ893EENDBB53.....	C4	P2LDX594VS	E15	P2M1PXSM.....	D54
P2LCX893EEHDDG48	C17	P2LDX.....	C37, C38	P2LDX594V.....	E15	P2M1PXSN	D54

Part Number Index
 Safety Guide
 Offer of Sale
 Part Number Index,
 Safety Guide, Offer of Sale



For inventory, lead times, and kit lookup, visit www.pdnplu.com

Model No.	Section / Page No.	Model No.	Section / Page No.	Model No.	Section / Page No.	Model No.	Section / Page No.
P2M1PXSR	D54	P2M1V3ES2CV	D41	P2M2HBVS11600	D160	P2M2T4PP	D37
P2M1PXST	D54	P2M1V4EE2CV	D41	P2M2HBVT12400	D43, D49	P2M2T4PS	D37
P2M1PXVA	D57	P2M1V4ES2CV	D41, D45, D61	P2M2HBVW12400	D43, D49	P2M2TCEE2C	D37
P2M1S3ES2C	D33	P2M1V4ES2CV00C7	D61	P2M2HEV0A	D43, D61	P2M2TCEE2CW	D37
P2M1S3ES2CW	D33	P2M1VCEE2CV	D41	P2M2HEV0D	D43	P2M2TCPP	D37
P2M1S3PS	D33	P2M1VDEE2CV	D41	P2M2HXT01	D37, D43, D61	P2M2TDEE2C	D37
P2M1S4EE2C	D33	P2M1VDEE2CV00C7	D61	P2M2HXT0T	D37, D43	P2M2TDEE2CW	D37
P2M1S4EE2CW	D33	P2M1VEEE2CV	D41	P2M2K0CA	D59	P2M2TDPP	D37
P2M1S4ES2C	D33	P2M1VGEE2CV	D41, D61	P2M2K0FA	D59	P2M2TEEE2C	D37
P2M1S4ES2CW	D33	P2M1VJEE2CV	D41, D61	P2M2K0JA	D59	P2M2TGEE2C	D37
P2M1S4PP	D33	P2M1VJEE2CV00F7	D61	P2M2K0PA	D59	P2M2TGEE2CW	D37
P2M1S4PS	D33	P2M1X3ES	D59	P2M2PXCA	D55	P2M2V3ES2CV	D41
P2M1SCEE2C	D33	P2M1X4EE	D59	P2M2PXFA	D55	P2M2V4EE2CV	D41, D61
P2M1SCEE2CW	D33	P2M1X4ES	D59	P2M2PXSG	D54	P2M2V4EE2CV00F9	D61
P2M1SCPP	D33	P2M1XCEE	D59	P2M2PXSL	D54	P2M2V4ES2CV	D41
P2M1SDEE2C	D33	P2M1XDEE	D59	P2M2PXSM	D54	P2M2V4ES2CV00F7	D45
P2M1SDEE2CW	D33	P2M1XEEE	D59	P2M2PXSN	D54	P2M2VCEE2CV	D41
P2M1SDPP	D33	P2M1XJEE	D59	P2M2PXSR	D54	P2M2VDEE2CV	D41
P2M1SEEE2C	D33	P2M2BXT0A	D37	P2M2PXST	D54	P2M2VEEE2CV	D41
P2M1SEEE2CW	D33	P2M2BXV0A	D43, D61	P2M2S3ES2C	D33	P2M2VGEE2CV	D41
P2M1SGEE2C	D33	P2M2BXV0A1F9MM	D61	P2M2S3ES2CW	D33	P2M2X3ES	D59
P2M1SGEE2CW	D33	P2M2HBVC21600	D160	P2M2S3PS	D33	P2M2X4EE	D59
P2M1T3ES2C	D37	P2M2HBVD21600	D160	P2M2S4EE2C	D33	P2M2X4ES	D59
P2M1T3ES2CW	D37	P2M2HBVE12400	D43, D49	P2M2S4ES2C	D33	P2M2XCEE	D59
P2M1T3PS	D37	P2M2HBVK12400	D160	P2M2S4ES2CW	D33	P2M2XDEE	D59
P2M1T4EE2C	D37	P2M2HBVL12400A13	D43, D51, D160, D163	P2M2S4PP	D33	P2M2XEEE	D59
P2M1T4EE2CW	D37	P2M2HBVL12400A13-SPC	D160, D163	P2M2S4PS	D33	P2M7BXG02NP	C63
P2M1T4ES2C	D37	P2M2HBVL12400A42	D43, D51, D160, D163	P2M2SCEE2C	D33	P2M7BXG04NP	C63
P2M1T4ES2CW	D37	P2M2HBVL12400A42-SPC	D160, D163	P2M2SCEE2CW	D33	P2M7BXG06NP	C63
P2M1T4PP	D37	P2M2HBVL12400A43	D43, D51, D160, D163	P2M2SCPP	D33	P2M7BXG08NP	C63
P2M1T4PS	D37	P2M2HBVL12400A43-SPC	D43, D51, D160, D163	P2M2SDEE2C	D33	P2M7BXN02NP	C63
P2M1TCEE2C	D37	P2M2HBVL12400A43-SPC	D160, D163	P2M2SDEE2CW	D33	P2M7BXN04NP	C63
P2M1TCEE2CW	D37	P2M2HBVL12400AB	D61	P2M2SDPP	D33	P2M7BXN06NP	C63
P2M1TCPP	D37	P2M2HBVL12400B25	D43, D51, D160, D163	P2M2SEEE2C	D33	P2M7BXN08NP	C63
P2M1TDEE2C	D37	P2M2HBVL12400B25-SPC	D160, D163	P2M2SEEE2CW	D33	P2MAV21F9MM05	D61
P2M1TDEE2CW	D37	P2M2HBVM12400	D43, D49	P2M2SGEE2C	D33	P2MAVB1F9MM05	D61
P2M1TDPP	D37	P2M2HBVN12400	D43, D49, D160	P2M2SGEE2CW	D33	P2N-VK0P	D256
P2M1TEEE2C	D37	P2M2HBVP21600	D160	P2M2T3ES2C	D37	P2N-VM500AK	D255
P2M1TEEE2CW	D37			P2M2T3ES2CW	D37	P2N-VM512MB	D255, D276
P2M1TGEE2C	D37			P2M2T3PS	D37	P2N-VM513ES	D255, D276
P2M1TGEE2CW	D37			P2M2T4EE2C	D37	P2N-VS512SD	D255, D270
P2M1TJEE2C	D37			P2M2T4EE2CW	D37	P2N-WK0P	D256
P2M1TJEE2CW	D37			P2M2T4ES2C	D37	P2N-WM513MB	D255, D276
P2M1TJPP	D37			P2M2T4ES2CW	D37	P2N-WM514ES	D255, D276

Part Number Index

Safety Guide

Offer of Sale

Part Number Index, Safety Guide, Offer of Sale



For inventory, lead times, and kit lookup, visit www.pdnplu.com

Model No.	Section / Page No.	Model No.	Section / Page No.	Model No.	Section / Page No.	Model No.	Section / Page No.
P2N-WS513SD	D255, D270	PEJ02-02-80.....	D241	PS2032J83CP	C26, C65, D130, D257	PS2815P	C47
P2N-YK0P.....	D256	PESC10	B6	PS2038P	E20	PS2817P	C47
P2N-YM514MB.....	D255, D276	PESC2001F	B6	PS2039P.....	E20	PS2818P	C47
P2N-YM518ES.....	D255, D276	PESC2020B	B6	PS2041P.....	E20	PS2819P	C47
P2N-YS514SD	D255, D270	PJL01.....	D271	PS2043P.....	E19	PS2820P	C47
P2PCX	C37	PJLP01	D271	PS2429BP	C6, C26, C65, D256	PS2828619P.....	D133, D257
P66829	E60	PJLP02	D271	PS2429JBP.....	C6, C26, C65, D256	PS2855P	D256
P66837	E60	PJLP02-201-70.....	D241, D242	PS243079BP ...	C6, C26, C65, D256	PS2869P	C47
P6M-PAB1	D9, D10, D11, F12	PJLP02-201-80.....	D241, D242	PS243083BP ...	C6, C26, C65, D256	PS2871P	C51
P6M-PAB2	F12	PKG 3M-*-PSG 3M/S90.....	D224	PS243087BP	C26, C65, D256	PS2871VP.....	C51
P6M-PAB3	D9, D10, D11, F12	PKG 3M-4/S90	D224	PS243087BP	C26, C65, D256	PS2884P	C51
P6M-PAB4	F12	PL01	D271	PS2430J79BP.....	C6, C26, C65, D256	PS2886P	C51
P6M-PAB6	F12	PL01-02-70.....	D242	PS2430J83BP.....	C6, C26, C65, D256	PS2887P	C52
P6M-PAB8	F12	PL01-02-80.....	D242	PS2501P.....	C68	PS2892P	C6, C26
P6M-PAC5	C28, C87, E17, F12	PL02	D271	PS2502P.....	C68	PS2893C##P	C65
P8BPA00MA	D226	PL02-01-70.....	D112	PS2503P.....	C68	PS2893CP	C65
P8BPA00MB	D225	PL02-01-70.....	D241	PS2504P.....	C68	PS2893D##P	C65
P8CS0803J.....	D34, D38	PL02-01-80.....	D112	PS2504P.....	C68	PS2893DP	C65
P8CS1204J.....	D34, D38	PL02-01-80.....	D241	PS2504P.....	C68	PS2896P	C51
P8CS1205AA.....	D42	PL1-1/4-70	D255, D270	PS2502P.....	C68	PS2901CP	C50
P8LMH20M*A	D47	PL1-1/4-80	D255, D270	PS2503P.....	C68	PS2902CP	C50
P8LMH20M2A.....	D42, D61	PL2-3/8-70	D255, D270	PS2504P.....	C68	PS2903CP	C50
P8LMH20M5A.....	D42, D47	PL2-3/8-80	D255, D270	PS257101P.....	C68	PS2904CP	C50
P8LMH20M9A.....	D42, D47	PL2-3/8-80	D255, D270	PS257102P.....	C68	PS2915P	C47
P8LMH25M3A.....	D12, D42, D46, D128, D225	PL2424P	E60	PS257102P.....	C68	PS2917P	C47
P8LS08L226C.....	D34, D38	PL2425P	E60	PS2584P.....	C68	PS2918P	C47
P8LS08L526C.....	D34, D38	PL3-1/2-70	D255, D270	PS2587P.....	C68	PS2918P	C47
P8LS08L926C.....	D34, D38	PL3-1/2-80	D255, D270	PS2597GBP.....	C68	PS2919P	C47
P8LW021C.....	D34, D38	PL37	E60	PS2597GCP.....	C68	PS2920P	C47
P8LW021C02.....	D34, D38	PL50	E60	PS2597NBP	C68	PS2932BP	B10
P8LW021C04.....	D34, D38	PMDYY1	D38, D42, D54	PS2597NCP.....	C68	PS2932BP	B10, C26, C40, C41, C48, C65, D257
P8LW021C08.....	D34, D38	PMDYY2	D34, D38, D42, D54	PS2601P.....	C52	PS2932HBP	B10, C26, C40, C41, C48, C65
PD1-1/4-70.....	D255, D270	PPRL15.....	E58, E59	PS2602P.....	C52	PS2932JBP.....	B10, C26, C40, C41, C48, C65, D257
PD1-1/4-80.....	D255, D270	PPS1-2C3-RHM.....	E54	PS2603P.....	C52	PS294675BP	B10, C26, C40, C41, C48, C65
PD2-3/8-70.....	D255, D270	PPS1-2C3-RWL.....	E54	PS2604P.....	C52	PS294679BP	B10, C26, C40, C41, C48, C65, D257
PD2-3/8-80.....	D255, D270	PS1556.....	C6, C26	PS2620P.....	C47	PS294683BP	B10, C26, C40, C41, C48, C65, D257
PEJ01	D271	PS2028BP	C26, C65, D130, D257	PS2684P.....	C52	PS294687BP	B10, C26, C40, C41, C48, C65
PEJ01-03-70.....	D242	PS2028JCP	C26, C65, D130, D257	PS2801*P	C51	PS2946J75BP.....	B10, C26, C40, C41, C48, C65
PEJ01-03-80.....	D242	PS203279BP	C26, C65, D130, D257	PS2801VP.....	C51	PS2946J79BP.....	B10, C26, C40, C41, C48, C65, D257
PEJ02	D271	PS203283BP	C26, C65, D130, D257	PS2802*P	C51		
PEJ02-02-70.....	D241	PS203279BP	C26, C65, D130, D257	PS2802VP.....	C51		
		PS203283BP	C26, C65, D130, D257	PS2803*P	C51		
		PS2032J79CP	C26, C65, D130, D257	PS2803VP.....	C51		
				PS2804*P	C51		
				PS2804VP.....	C51		

Part Number Index
Safety Guide
Offer of Sale
Part Number Index, Safety Guide, Offer of Sale



For inventory, lead times, and kit lookup, visit www.pdnplu.com

Model No.	Section / Page No.	Model No.	Section / Page No.	Model No.	Section / Page No.	Model No.	Section / Page No.
PS2946J83BP..B10, C26, C40, C41, C48, C65, D257		PS4011560CP	D245	PS4051060BP	D134	PS4137	D251
PS2969P	C47	PS401165	D249	PS4051160BP	D134	PS4137166CP	D103, D246
PS2971CP	C50	PS4011650CP	D245	PS4051CP	D134	PS4137266CP	D103, D246
PS2980P	C50	PS401166	D249	PS4052160BP	D134	PS4138	D144
PS2981P	C50	PS4011660CP	D245	PS4052CP	D133, D257	PS4138166CP	D79
PS2982*##P	B10	PS4013P	D245	PS4053060BP	D134	PS4138266CP	D79
PS2982*##P	C24, C48, C50, C51, C52, C60, C61, C68	PS401500CP	D106, D256	PS4053160BP	D134	PS4139P	D133
PS2982B49P	D257	PS401501CP	D106, D256	PS4053CP	D133, D257	PS4140P	D134
PS2982B53P	D257	PS402501	D250	PS4087DP	D133	PS4142CP	D103, D256
PS2982C49P	D257	PS402601	D250	PS40D3DP	D133	PS4145BP	D134
PS2982C53P	D257	PS402701	D250	PS4101CP	D133	PS4147BP	D134
PS2984P	C50	PS402801	D250	PS4102CP	D133	PS4148BP	D134
PS2987P	C50	PS403000CP	D245	PS4103CP	D133	PS4150030BP	D134
PS2996P	C50	PS403001CP	D245	PS4104CP	D133	PS4150060BP	D134
PS2998P	C40, C41, C48, C65	PS4031010CP	D245	PS4105DP	D133	PS4150125BP	D134
PS3202*##P	B10	PS4031011DP	D245	PS4106DP	D133	PS4187DP	D133
PS3441*##P	B10	PS4032CP	D256	PS4111	D138, D275	PS41D3DP	D133
PS3541*##P	B10	PS4033CP	D256	PS411117	D249	PS41D5DP	D133
PS3541*##P	C50, C51, C52, C68	PS4033CP	D92, D114	PS4111170CP	D103, D246	PS4201CP	D133
PS4001CP	D133	PS4034CP	D78, D101, D256	PS411117ACP	D79	PS4202CP	D133
PS4002CP	D133	PS4035CP	D78	PS411117CCP	D79	PS4203CP	D133
PS4003CP	D133	PS4036P	D134	PS411118	D249	PS4204CP	D133
PS4004CP	D133	PS4037	D144, D251	PS4111180CP	D103, D246	PS4205DP	D133
PS4005DP	D133	PS4037166CP	D101, D245	PS411118ACP	D79	PS4206DP	D133
PS4006DP	D133	PS4037266CP	D101, D245	PS411118CCP	D79	PS4211	D139, D142, D144, D275
PS4007P	D133	PS4038	D144	PS411127	D249	PS421110	D249
PS4011	D138	PS4038166CP	D78	PS411128	D249	PS421110ACP	D91
PS4011	D275	PS4038266CP	D78	PS411157	D249	PS421110CCP	D91
PS401115	D249	PS4039P	D133	PS411158	D249	PS4211170CP	D247
PS4011150DP	D101, D245	PS4040P	D134	PS411167	D249	PS4211180CP	D114, D247
PS4011158FDP	D78	PS404123P	D133	PS4111670CP	D246	PS421119	D249
PS401115ADP	D78	PS404142P	D133	PS411168	D249	PS4211190CP	D114
PS401115CDP	D78	PS404145P	D133	PS4111680CP	D246	PS421119ACP	D91
PS401116	D249	PS404157P	D133	PS4113P	D246	PS421119CCP	D91
PS4011160DP	D101, D245	PS4041B9P	D133	PS411500CP	D106, D256	PS421120	D249
PS4011168FDP	D78	PS4041F9P	D133	PS411501CP	D106, D256	PS421129	D249
PS401116ADP	D78	PS4042CP	D101, D256	PS4131010DP	D246	PS421150	D249
PS401116CDP	D78	PS4045BP	D134	PS4131011DP	D246	PS4211500CP	D114
PS401155	D249	PS4047BP	D134	PS4132CP	D256	PS421150ACP	D91
PS4011550DP	D245	PS4048BP	D134	PS4134CP	D79, D103, D256	PS421150CCP	D91
PS401156	D249	PS4050030P	D134	PS4135CP	D79	PS421150MCP	D91
		PS4050060P	D134	PS4136P	D134	PS4211590CP	D114, D118
		PS4050125P	D134	PS4137	D144	PS421159ACP	D91

Part Number Index
Safety Guide
Offer of Sale
Part Number Index, Safety Guide, Offer of Sale



For inventory, lead times, and kit lookup, visit www.pdnplu.com

Model No.	Section / Page No.	Model No.	Section / Page No.	Model No.	Section / Page No.	Model No.	Section / Page No.
PS421159CCP	D91	PS4232CP	D92, D114, D256	PS5537155P	D99	PS5637255DXP	D234
PS421159MCP	D91			PS5537166DXP	D235	PS5637255P	D98
PS421160	D249	PS4234CP	D92, D114, D256	PS5537166P	D99	PS5637266DXP	D234
PS4211600CP	D114, D247	PS4235CP	D92	PS5537255DXP	D235	PS5637266P	D98
PS421160ACP	D91	PS4236P	D134	PS5537255P	D99	PS5638155P	D76
PS421160CCP	D91	PS4237	D144, D251	PS5537266DXP	D235	PS5638166P	D76
PS421160MCP	D91	PS4237166CP	D114, D118, D247	PS5537266P	D99	PS5638255P	D76
PS421169	D249			PS5538255P	D77	PS5638266P	D76
PS4211690CP	D114, D247	PS4237266CP	D114, D247	PS5538266P	D77	PS5642P	D98, D244
PS421169ACP	D91	PS4238	D144	PS5542P	D99, D244	PS5651160P	D76, D85, D98, D109, D234, D235
PS421169CCP	D91	PS4238166CP	D92	PS5587P	D133	PS567900	D26
PS421169MCP	D91	PS4238266CP	D92	PS55XXA0P	D77, D84, D99, D108	PS567904	D9, D26
PS4212P	D92, D114, D133, D247	PS4240P	D134			PS567906	D9, D26
PS421500CP	D116, D256	PS4242CP	D114, D256	PS55XXE0P	D84, D108	PS567925	D9, D10, D11, D26
PS421501CP	D116, D256	PS4287DP	D133	PS55XXM0P	D84, D108		
PS4220L20DP	D90	PS42D3DP	D133	PS5601P	D133	PS568204	D9, D26
PS4220L21DP	D90	PS42D5DP	D133	PS5602P	D133	PS568206	D9, D26
PS4220L30DP	D90	PS5501P	D133	PS5603P	D133	PS568215	D9, D26
PS4220L31DP	D90	PS5502P	D133	PS5604P	D133	PS568225	D9, D26
PS4220L40DP	D90	PS5503P	D133	PS5605P	D133	PS568308	D9, D27
PS4220L41DP	D90	PS5504P	D133	PS5611	D237, D272	PS568310	D9, D27
PS4220L60DP	D90	PS5505P	D133	PS5611510P	D234	PS568325	D9, D27
PS4220L61DP	D90	PS5511	D237, D272	PS5611520P	D234	PS568338	D9, D10, D11, D27
PS4220M20DP	D90	PS5511130P	D99	PS5612P	D244	PS5687P	D133
PS4220M21DP	D90	PS551113CP	D77	PS561600P	D76	PS5706	D12
PS4220M40DP	D90	PS5511140P	D99	PS561601P	D76	PSBJ708	F24
PS4220M41DP	D90	PS551114CP	D77	PS561AP	D244	PSBJ708-2G	F36
PS4220N20DP	D90, D168	PS5511530P	D235	PS561BP	D244	PSBJ708-4G	F36
PS4220N21DP	D90, D168	PS5511540P	D235	PS561CP	D244	PSBJ708-4G	F36
PS4220S20DP	D90, D168	PS5512P	D244	PS561DP	D244	PSBJ731	F24
PS4220S21DP	D90, D168	PS551500P	D106, D235, D239	PS562600P	D98, D234	PSBJ731-0	F36
PS4220S40DP	D90, D168			PS562601P	D98, D234	PSBJ731-2	F36
PS4220S41DP	D90, D168	PS551500P	D106, D235, D239	PS562700P	D234	PSBJ731-2G	F36
PS4220S50DP	D90, D168	PS552600P	D77, D99, D235	PS562701P	D234	PSBJ731-4	F36
PS4220S51DP	D90, D168	PS552601P	D77, D99, D235	PS5631010P	D234, D235	PSBJ731-4G	F36
PS4220T10DP	D90	PS552700P	D235	PS5631011P	D234	PSBJ731-6	F36
PS4220T11DP	D90	PS552701P	D235	PS5634P	D76, D98, D244	PSBJ731-6G	F36
PS4220T20DP	D90	PS5531011P	D235	PS5635P	D76	PSBJ731-8	F36
PS4220T21DP	D90	PS5534P	D77, D99, D244	PS5636P	D134	PSBJ731-8G	F36
PS4231010DP	D90, D114, D247	PS5535P	D77	PS5637	D144, D272	PSBJ731-M5	F36
PS4231011DP	D90, D114, D247	PS5536P	D134	PS5637155DXP	D234	PSG 3M-*/S90	D224
		PS5537	D144, D272	PS5637155P	D98	PSHU10P	D133
		PS5537155DXP	D235	PS5637166DXP	D234	PSHU115101P	D98, D111
				PS5637166P	D98	PSHU1151J1P	D76

Part Number Index
 Safety Guide
 Offer of Sale
 Part Number Index, Safety Guide, Offer of Sale



For inventory, lead times, and kit lookup, visit www.pdnplu.com

Model No.	Section / Page No.	Model No.	Section / Page No.	Model No.	Section / Page No.	Model No.	Section / Page No.
PSHU1151M1P.....	D76	PSHU20L500P.....	D75	PSHU20S201P.....	D75, D168	PSM21MAP.....	D4, D10, D11
PSHU115201P.....	D98	PSHU20L501P.....	D75	PSHU20S400P.....	D75, D168	PSM22JAP.....	D4
PSHU1152J1P.....	D76	PSHU20L600P.....	D75	PSHU20S401P.....	D75, D168	PSM22MAP.....	D4
PSHU1152M1P.....	D76	PSHU20L601P.....	D75	PSHU20S500P.....	D75, D168	PSM31JAPE7E7E7E7.....	D11
PSHU115301P.....	D99, D111	PSHU20M200P.....	D75	PSHU20S501P.....	D75, D168	PSM31MAPN7N7N7N7.....	D11
PSHU1153J1P.....	D77	PSHU20M201P.....	D75	PSHU20T100P.....	D75	PSM3BXN02NP.....	C46
PSHU1153M1P.....	D77	PSHU20M400P.....	D75	PSHU20T101P.....	D75	PSM3BXN04NP.....	C46
PSHU115401P.....	D99	PSHU20M401P.....	D75	PSHU20T200P.....	D75	PSM3BXN06NP.....	C46
PSHU1154J1P.....	D77	PSHU20M500P.....	D75	PSHU20T201P.....	D75	PSM3BXN08NP.....	C46
PSHU1154M1P.....	D77	PSHU20M501P.....	D75	PSHU31L000P.....	D98, D99, D101, D103	PSM5BXN02NP.....	C46
PSHU115501P.....	D101, D111	PSHU20N200P.....	D75, D168	PSHU31L001P.....	D98, D99, D101, D103	PSM5BXN04NP.....	C46
PSHU1155J1P.....	D78	PSHU20N201P.....	D75, D168	PSHU4000P.....	D80, D104	PSM5BXN06NP.....	C46
PSHU1155M1P.....	D78	PSHU20P300 PEAAB0-P5.....	D75	PSHU41.....	D142	PSM5BXN08NP.....	C46
PSHU115601P.....	D101	PSHU20P300 PEAAN0-P4.....	D75	PSHU4100P.....	D80, D104	PSM6BXN02NP.....	C46
PSHU1156J1P.....	D78	PSHU20P300 PEAAN0-P4.....	D75	PSHU4101P.....	D80, D104	PSM6BXN04NP.....	C46
PSHU1156M1P.....	D78	PSHU20P300PEAAA-P4.....	D182	PSHU42.....	D142	PSM6BXN06NP.....	C46
PSHU115701P.....	D103, D111	PSHU20P300PEAAA-P5.....	D182	PSHU4200P.....	D80, D104	PSM6BXN08NP.....	C46
PSHU1157J1P.....	D79	PSHU20P300PEAAA-P5.....	D182	PSHU4201P.....	D80, D104	PSML21AP.....	D5
PSHU1157M1P.....	D79	PSHU20P300PEAAA-S4.....	D182	PSHU60P.....	D80, D134	PSML22AP.....	D5
PSHU115801P.....	D103	PSHU20P300PEAAA-S4.....	D182	PSHU7100P.....	D80	PSML25AP.....	D5, D9
PSHU1158J1P.....	D79	PSHU20P300PEAAA-S5.....	D182	PSHU7101P.....	D80	PSML26AP.....	D5
PSHU1158M1P.....	D79	PSHU20P300PEAAB-P4.....	D182	PSHU7200P.....	D80	PSML61AP.....	D5
PSHU11P.....	D84, D98, D99, D108	PSHU20P300PEAAB-P4.....	D182	PSHU7201P.....	D80	PSML62AP.....	D5
PSHU12P.....	D84, D98, D99, D108	PSHU20P300PEAAB-P5.....	D182	PSHU7300P.....	D104	PSML65AP.....	D5
PSHU13P.....	D84, D98, D99, D108	PSHU20P300PEAAB-S5.....	D182	PSHU7301P.....	D104	PSML66AP.....	D5
PSHU14P.....	D84, D98, D99, D108	PSHU20P300PEAAC-P5.....	D182	PSM0001.....	D12, D18	PSMM41AP.....	D5
PSHU15P.....	D84, D98, D99, D108	PSHU20P300PEAAC-P5.....	D182	PSM0002.....	D12, D18	PSMM42AP.....	D5
PSHU16P.....	D84, D98, D99, D108	PSHU20P300PEAAC-S5.....	D182	PSM0003.....	D12, D18	PSMM45AP.....	D5, D10
PSHU17P.....	D84, D98, D99, D108	PSHU20P300PEAAN-P4.....	D182	PSM0004.....	D12, D18	PSMM46AP.....	D5
PSHU18P.....	D84, D98, D99, D108	PSHU20P300PEAAN-P4.....	D182	PSM001*.....	D26	PSMM51AP.....	D5
PSHU20L100P.....	D75	PSHU20P300PEAAN-P5.....	D182	PSM0010.....	D12	PSMM52AP.....	D5
PSHU20L101P.....	D75	PSHU20P300PEAAN-S5.....	D182	PSM0011.....	D12	PSMM55AP.....	D5, D11
PSHU20L200P.....	D75	PSHU20P300PEABC-P4.....	D182	PSM0012.....	D12	PSMM56AP.....	D5
PSHU20L201P.....	D75	PSHU20P300PEABC-P5.....	D182	PSM0013.....	D12, D26	PSMM61AP.....	D5
PSHU20L300P.....	D75	PSHU20P301 PEAAB0-P5.....	D75	PSM0014.....	D12	PSMM62AP.....	D5
PSHU20L301P.....	D75	PSHU20P301 PEAAN0-P4.....	D75	PSM0022.....	D12	PSMM65AP.....	D5, D11
PSHU20L400P.....	D75	PSHU20P301 PEAAN0-P4.....	D75	PSM0025.....	D12	PSMM66AP.....	D5
PSHU20L401P.....	D75	PSHU20S200P.....	D75, D168	PSM002E.....	D12	PSMM71AP.....	D5
				PSM002N.....	D12	PSMM72AP.....	D5
				PSM002P.....	D12	PSMM75AP.....	D5
				PSM002Q.....	D12	PSMM76AP.....	D5
				PSM21JAP.....	D4, D9, D10, D11	PSMRAX6AP.....	D9
						PSMT11AP.....	D5
						PSMT12AP.....	D5

Part Number Index
Safety Guide
Offer of Sale
Part Number Index, Safety Guide, Offer of Sale



For inventory, lead times, and kit lookup, visit www.pdnplu.com

Model No.	Section / Page No.	Model No.	Section / Page No.	Model No.	Section / Page No.	Model No.	Section / Page No.
PSMT15AP	D5	PSSTR4M12A	D191, D195, D203	PXBB3111BC2	E67	PXCK22100	E77
PSMT16AP	D5			PXBB3111BD2.....	E67	PXCK2210031	E77, E82
PSMT21AP	D5	PSSTR4MRA.....	D202	PXBB3111BT4.....	E67	PXCK2210041	E77, E82
PSMT22AP	D5	PSSV32A	D134, D197, D202, D203	PXBB3121B	E69	PXCK22101	E76, E82
PSMT25AP	D5	PSSVEXT1	D11	PXBB3121BT4.....	E67	PXCK22102	E76, E82
PSMT26AP	D5	PSSVEXT1	D192, D193, D194	PXBB3211BD2.....	E67	PXCK22106	E76, E82
PSMXN##NP.....	B6			PXBB3211BD3.....	E67	PXCK22121	E76, E82
PSPE701.....	F24	PSSVM32A	D197, D202, D203	PXBB3211BJ5	E67	PXCM111.....	E75, E80, E81
PSPE701-2G.....	F36			PXBB3251BA2.....	E67	PXCM115.....	E75
PSPE701-4G.....	F36	PSXM2186P.....	B6	PXBB3251BD2.....	E67	PXCM121.....	E75, E80, E81
PSPE701-6G.....	F36	PSXM31010P.....	B6	PXBB3251BD3.....	E67	PXCM125.....	E75
PSPE701-8G.....	F36	PSXM40900P.....	B6	PXBB3911	E69, E72	PXCM131.....	E81
PSPE701-M5	F36	PSXM530CP	B6	PXBB3912	E69	PXCM521.....	E75, E80, E81
PSPJ731	F24	PSXM8100P.....	B6	PXBB3921	E69	PXCM601A102	E76, E80, E81
PSPJ731-2.....	F36	PSXM8288P.....	B6	PXBB3922	E69		
PSPJ731-4.....	F36	PSXM8310P.....	B6	PXB-B4	E74	PXCM601A103	E76, E80, E81
PSPJ731-6.....	F36	PWBA1412/3412	F19	PXBB4131B	E69	PXCM601A110	E76, E80, E81
PSSBASE.....	D192	PWBA1468/3468	F19	PXBB4131BA2.....	E67	PXCZ11.....	E75, E81
PSSCDM12A	D11	PWBA1469/3469	F19	PXBB4131BA3.....	E67	PXCZ12.....	E81
PSSCENA	D190, D197, D203	PWBA1483	F19	PXBB4131BA4.....	E67	PXPA11	E59
PSSCPBA	D190, D197, D203	PWBA1489	F19	PXBB4131BC2	E67	PXPC111	E59
PSSN16M12A.....	D190, D195, D203	PWBA1493/3493	F19	PXBB4131BD2.....	E67	PXVF111	E71
		PWBA1822/3822	F19	PXBB4131BT4	E67	PXVF1211	E71
PSSN16xxx.....	D202	PWBA1833/3833	F19	PXBB4231BA2.....	E67	PXVF1212	E71
PSSN8M12A.....	D11, D190, D195, D203	PWBA1898/3888	F19	PXBB4231BD2.....	E67	PXVF1213	E71
		PWBA1899/3899	F19	PXBB4231BD3.....	E67	PXVF1214	E71
PSSN8M8A.....	D190, D195, D203	PWBA38227	F19	PXBB4231BJ5	E67	PXVF1215	E71
		PWBA38337	F19	PXBB4931	E69, E72	PXVF1216	E71
PSSN8xxx.....	D202	PWBA38887	F19	PXBB4932	E69, E72	PXVF131	E71
PSSNACM12A.....	D191, D196, D202, D203	PWBA38997	F19	PXCJ117	E78, E83	PXVF141	E71
		PWSB1227	F17, F19	PXCJ11701	E78	PXVF151	E71
PSSNAVM12A.....	D191, D196, D202, D203	PWSB1337	F17, F19	PXCJ11705.....	E78	PXVF161	E71
		PWSB1557	F17, F19	PXCJ127	E78, E83		
PSSP8xxx	D202	PWSB1887	F17, F19	PXCJ12701	E78	R	
PSSSE24A.....	D191, D193, D194, D197, D199, D203	PWSB1997	F17, F19	PXCJ12705.....	E78	RKC 4.4T*-RSC 4.4T.....	D130, D224
		PWSE101.....	F18	PXCK211	E77, E82	RKC 4.4T-1	D130, D224
PSST16M12A	D191, D195, D203	PWSE111.....	F18	PXCK21100	E77	RKC 4.4T-2	C26
		PWSM1012.....	F17, F18, F19	PXCK2110031	E77, E82	RKC 4.5T-*/S1587.....	D130, D224
PSST16xxx.....	D202	PWSP111	F17, F18, F19	PXCK2110041	E77, E82		
PSST8M12A	D191, D195, D203	PXB-B3.....	E74	PXCK21101	E76, E82	RKC 4.5T*-RSC 4.5T/S1587 ...	D130, D163, D224
		PXBB3111B.....	E59, E69	PXCK21102	E76, E82	RKC 4.5T*-RSC 4.5T/S1587 ...	D42, D51
PSST8M23A	D191, D195, D203	PXBB3111BA2.....	E67	PXCK21106	E76, E82		
		PXBB3111BA3.....	E67	PXCK21121	E76, E82	RKC4.4T-2	D84, D108
PSST8xxx.....	D202	PXBB3111BA4.....	E67				
PSSTERM	D191			PXCK221	E77, E82		

Part Number Index
 Safety Guide
 Offer of Sale
 Part Number Index,
 Safety Guide, Offer of Sale



For inventory, lead times, and kit lookup, visit www.pdnplu.com

Model No.	Section / Page No.	Model No.	Section / Page No.	Model No.	Section / Page No.	Model No.	Section / Page No.
RKM 46-5M/S1587	D130, D224	W68PLCKI-5/32-2	F33	ZB4BC2	E68	ZBE101	E70
RKM 56-5M/S1587	D130, D224	W68PLCKI-6-4	F33	ZB4BC3	E68	ZBE102	E70
RSC 4.4T*	D130, D224	W68PLCKI-6-6	F33	ZB4BC4	E68	ZBY2002	E70
RSC 4.5T-4/S1587	D130, D224	WKM 46-5M/S1587	D130, D224	ZB4BD2	E68	ZBY2101	E70
RSC RKC 5711-xM	D226	WKM 56-5M/S1587	D130, D224	ZB4BD3	E68	ZBY2303	E70
RSC RKM 5711-xM	D226	WPASV13000-AA-34	C78	ZB4BD4	E68	ZBY2304	E70
RSM 57-TR2	D226	WPASV13000-AA-94	C78	ZB4BD5	E68	ZBY2305	E70
RSM RKC 5711-xM	D226	WPASV15000-AA-42	C79	ZB4BD7	E68	ZBY2306	E70
RSM RKM 46-x/S1587	D130, D224	WPASV15000-AA-92	C79	ZB4BD8	E68	ZBY2307	E70
RSM RKM 56-x/S1587	D130, D224	WPASV2000-AA-17	C76	ZB4BG2	E68	ZBY2308	E70
RSM RKM 57 WSM 40 PST	D226	WPASV2000-AA-97	C76	ZB4BG3	E68	ZBY2309	E70
RSM RKM 5711-xM	D226	WPASV200-AA-M5	C75	ZB4BG4	E68	ZBY2310	E70
RSM-2RKM 40	D224	WPASV200-AA-M5	C75	ZB4BG5	E68	ZBY2311	E70
RSM-2RKM 50	D224	WPASV5000-AA-21	C77	ZB4BG7	E68	ZBY2312	E70
RSSD RJ45S 443-2M	D225	WPASV5000-AA-91	C77	ZB4BH02	E68	ZBY2313	E70
RSSD RKSD 443-xM	D225		X	ZB4BH03	E68	ZBY2314	E70
RSSW RKSW 455-xM	D225	XCMZ24	E80	ZB4BH04	E68	ZBY2321	E70
S		XM30NB49A	B3	ZB4BJ2	E68	ZBY2323	E70
S421159	D249	XM30NB549A	B3	ZB4BJ3	E68	ZBY2326	E70
SCD253W	D12, D42, D46	XM30NB553A	B3	ZB4BJ4	E68	ZBY2327	E70
SCD253W	D128, D225	XM30NBG49A	B3	ZB4BJ5	E68	ZBY2328	E70
SCD259D	D12, D42, D46	XM30NBG53A	B3	ZB4BL2	E68	ZBY2330	E70
SCD259D	D128, D225	XM30NBH49A	B3	ZB4BL3	E68	ZBY2334	E70
SCD259WE	D12, D42, D46	XM30NBH53A	B3	ZB4BL4	E68	ZBY2367	E70
SCD259WE	D128, D225	XM3VNB549A	B3	ZB4BL5	E68	ZBY2387	E70
V		XM3VNB553A	B3	ZB4BP2	E68	ZBY4101	E70
VC	F23	XM3VNBG49A	B3	ZB4BP3	E68	ZBZ1602	E71
VDMA	D270	XM3VNBG53A	B3	ZB4BP4	E68	ZC2JE01	E78
VL37	E60	XM40NB549A	B3	ZB4BR	E59	ZC2JE02	E78
VL50	E60	XM40NB553A	B3	ZB4BR2	E68	ZC2JE03	E78
W		XM40NBG49A	B3	ZB4BR3	E68	ZC2JE05	E78
W68PLCK	F23	XM40NBG53A	B3	ZB4BR4	E68	ZC2JE09	E78
W68PLCK-4-2	F33	XM40NBH49A	B3	ZB4BS844	E68	ZC2JE61	E78, E83
W68PLCK-4-4	F33	XM40NBH53A	B3	ZB4BS944	E68	ZC2JE62	E78, E83
W68PLCK-5/32-2	F33	XM4VNB549A	B3	ZB4BT2	E68	ZC2JE63	E78
W68PLCK-6-4	F33	XM4VNB553A	B3	ZB4BZ009	E68	ZC2JE70	E78, E83
W68PLCK-6-6	F33	XM4VNBG49A	B3	ZB5AA2	E68	ZC2JY11	E78, E83
W68PLCKI	F23	XM4VNBG53A	B3	ZB5AA3	E68	ZC2JY13	E78
W68PLCKI-4-2	F33	ZB2BY2002	E70	ZB5AA4	E68	ZC2JY21	E78
W68PLCKI-4-4	F33	ZB4BA2	E68	ZB5AL2	E68	ZC2JY31	E78, E83
W68PLCKI	F23	ZB4BA3	E68	ZB5AL3	E68	ZC2JY41	E78, E83
W68PLCKI-4-2	F33	ZB4BA4	E68	ZB5AL4	E68	ZC2JY51	E83
W68PLCKI-4-4	F33	ZB4BA5	E68	ZB5AZ009	E68	ZC2JY61	E78
		ZB4BA6	E68	ZB5AZ905	E71	ZC2JY71	E78

Part Number Index
Safety Guide
Offer of Sale
Part Number Index, Safety Guide, Offer of Sale



For inventory, lead times, and kit lookup, visit www.pdnplu.com

Model No.	Section / Page No.	Model No.	Section / Page No.	Model No.	Section / Page No.	Model No.	Section / Page No.
ZC2JY81	E78, E83						
ZC2JY91	E78, E83						
ZCKD02	E78						
ZCKD06	E78						
ZCKD10	E78						
ZCKD21	E78						
ZCKD23	E78						
ZCKG00	E78						
ZCKY11	E78						
ZCKY13	E78						
ZCKY41	E78						
ZCKY43	E78						
ZCKY51	E78						
ZCKY52	E78						
ZCKY81	E78, E82						
ZCKY91	E78, E82						

Part Number Index

Safety Guide

Offer of Sale

Part Number Index, Safety Guide, Offer of Sale



For inventory, lead times, and kit lookup, visit www.pdnplu.com

Safety Guide For Selecting And Using Pneumatic Division Products And Related Accessories

WARNING:

FAILURE OR IMPROPER SELECTION OR IMPROPER USE OF PNEUMATIC DIVISION PRODUCTS, ASSEMBLIES OR RELATED ITEMS (“PRODUCTS”) CAN CAUSE DEATH, PERSONAL INJURY, AND PROPERTY DAMAGE. POSSIBLE CONSEQUENCES OF FAILURE OR IMPROPER SELECTION OR IMPROPER USE OF THESE PRODUCTS INCLUDE BUT ARE NOT LIMITED TO:

- Unintended or mistimed cycling or motion of machine members or failure to cycle
- Work pieces or component parts being thrown off at high speeds.
- Failure of a device to function properly for example, failure to clamp or unclamp an associated item or device.
- Explosion
- Suddenly moving or falling objects.
- Release of toxic or otherwise injurious liquids or gasses.

Before selecting or using any of these Products, it is important that you read and follow the instructions below.

1. GENERAL INSTRUCTIONS

- 1.1. Scope:** This safety guide is designed to cover general guidelines on the installation, use, and maintenance of Pneumatic Division Valves, FRLs (Filters, Pressure Regulators, and Lubricators), Vacuum products and related accessory components.
- 1.2. Fail-Safe:** Valves, FRLs, Vacuum products and their related components can and do fail without warning for many reasons. Design all systems and equipment in a fail-safe mode, so that failure of associated valves, FRLs or Vacuum products will not endanger persons or property.
- 1.3. Relevant International Standards:** For a good guide to the application of a broad spectrum of pneumatic fluid power devices see: ISO 4414: 1998, Pneumatic Fluid Power – General Rules Relating to Systems. See www.iso.org for ordering information.
- 1.4. Distribution:** Provide a copy of this safety guide to each person that is responsible for selection, installation, or use of Valves, FRLs or Vacuum products. Do not select, or use Parker valves, FRLs or vacuum products without thoroughly reading and understanding this safety guide as well as the specific Parker publications for the products considered or selected.
- 1.5. User Responsibility:** Due to the wide variety of operating conditions and applications for valves, FRLs, and vacuum products Parker and its distributors do not represent or warrant that any particular valve, FRL or vacuum product is suitable for any specific end use system. This safety guide does not analyze all technical parameters that must be considered in selecting a product. The user, through its own analysis and testing, is solely responsible for:
 - Making the final selection of the appropriate valve, FRL, Vacuum component, or accessory.
 - Assuring that all user’s performance, endurance, maintenance, safety, and warning requirements are met and that the application presents no health or safety hazards.
 - Complying with all existing warning labels and / or providing all appropriate health and safety warnings on the equipment on which the valves, FRLs or Vacuum products are used; and,
 - Assuring compliance with all applicable government and industry standards.
- 1.6. Safety Devices:** Safety devices should not be removed, or defeated.
- 1.7. Warning Labels:** Warning labels should not be removed, painted over or otherwise obscured.
- 1.8. Additional Questions:** Call the appropriate Parker technical service department if you have any questions or require any additional information. See the Parker publication for the product being considered or used, or call 1-800-CPARKER, or go to www.parker.com, for telephone numbers of the appropriate technical service department.

2. PRODUCT SELECTION INSTRUCTIONS

- 2.1. Flow Rate:** The flow rate requirements of a system are frequently the primary consideration when designing any pneumatic system. System components need to be able to provide adequate flow and pressure for the desired application.
- 2.2. Pressure Rating:** Never exceed the rated pressure of a product. Consult product labeling, Pneumatic Division catalogs or the instruction sheets supplied for maximum pressure ratings.
- 2.3. Temperature Rating:** Never exceed the temperature rating of a product. Excessive heat can shorten the life expectancy of a product and result in complete product failure.
- 2.4. Environment:** Many environmental conditions can affect the integrity and suitability of a product for a given application. Pneumatic Division products are designed for use in general purpose industrial applications. If these products are to be used in unusual circumstances such as direct sunlight and/or corrosive or caustic environments, such use can shorten the useful life and lead to premature failure of a product.
- 2.5. Lubrication and Compressor Carryover:** Some modern synthetic oils can and will attack nitrile seals. If there is any possibility of synthetic oils or greases migrating into the pneumatic components check for compatibility with the seal materials used. Consult the factory or product literature for materials of construction.
- 2.6. Polycarbonate Bowls and Sight Glasses:** To avoid potential polycarbonate bowl failures:
 - Do not locate polycarbonate bowls or sight glasses in areas where they could be subject to direct sunlight, impact blow, or temperatures outside of the rated range.
 - Do not expose or clean polycarbonate bowls with detergents, chlorinated hydro-carbons, ketones, esters or certain alcohols.
 - Do not use polycarbonate bowls or sight glasses in air systems where compressors are lubricated with fire resistant fluids such as phosphate ester and di-ester lubricants.
- 2.7. Chemical Compatibility:** For more information on plastic component chemical compatibility see Pneumatic Division technical bulletins Tec-3, Tec-4, and Tec-5

- 2.8. Product Rupture:** Product rupture can cause death, serious personal injury, and property damage.
- Do not connect pressure regulators or other Pneumatic Division products to bottled gas cylinders.
 - Do not exceed the maximum primary pressure rating of any pressure regulator or any system component.
 - Consult product labeling or product literature for pressure rating limitations.

3. PRODUCT ASSEMBLY AND INSTALLATION INSTRUCTIONS

- 3.1. Component Inspection:** Prior to assembly or installation a careful examination of the valves, FRLs or vacuum products must be performed. All components must be checked for correct style, size, and catalog number. DO NOT use any component that displays any signs of nonconformance.
- 3.2. Installation Instructions:** Parker published Installation Instructions must be followed for installation of Parker valves, FRLs and vacuum components. These instructions are provided with every Parker valve or FRL sold, or by calling 1-800-CPARKER, or at www.parker.com.
- 3.3. Air Supply:** The air supply or control medium supplied to Valves, FRLs and Vacuum components must be moisture-free if ambient temperature can drop below freezing

4. VALVE AND FRL MAINTENANCE AND REPLACEMENT INSTRUCTIONS

- 4.1. Maintenance:** Even with proper selection and installation, valve, FRL and vacuum products service life may be significantly reduced without a continuing maintenance program. The severity of the application, risk potential from a component failure, and experience with any known failures in the application or in similar applications should determine the frequency of inspections and the servicing or replacement of Pneumatic Division products so that products are replaced before any failure occurs. A maintenance program must be established and followed by the user and, at minimum, must include instructions 4.2 through 4.9. Failure to follow routine maintenance can lead to a reduction in the expected service life of the product and can result in damage to the system, personal injury and/or property damage.
- 4.2. Installation and Service Instructions:** Before attempting to service or replace any worn or damaged parts consult the appropriate Service Bulletin for the valve or FRL in question for the appropriate practices to service the unit in question. These Service and Installation Instructions are provided with every Parker valve and FRL sold, or are available by calling 1-800-CPARKER, or by accessing the Parker website at www.parker.com.
- 4.3. Lockout / Tagout Procedures:** Be sure to follow all required lockout and tagout procedures when servicing equipment. For more information see: OSHA Standard – 29 CFR, Part 1910.147, Appendix A, The Control of Hazardous Energy – (Lockout / Tagout)
- 4.4. Visual Inspection:** Any of the following conditions requires immediate system shut down and replacement of worn or damaged components:
- Air leakage: Look and listen to see if there are any signs of visual damage to any of the components in the system. Leakage is an indication of worn or damaged components.
 - Damaged or degraded components: Look to see if there are any visible signs of wear or component degradation including but not limited to swelling, bulging, creaks or leaks.
 - Kinked, crushed, or damaged hoses. Kinked hoses can result in restricted air flow and lead to unpredictable system behavior.
 - Any observed improper system or component function: Immediately shut down the system and correct malfunction.
 - Excessive dirt build-up: Dirt and clutter can mask potentially hazardous situations.

Caution: Leak detection solutions should be rinsed off after use.

- 4.5. Routine Maintenance Issues:**
- Remove excessive dirt, grime and clutter from work areas.
 - Make sure all required guards and shields are in place.
- 4.6. Functional Test:** Before initiating automatic operation, operate the system manually to make sure all required functions operate properly and safely.
- 4.7. Service or Replacement Intervals:** It is the user’s responsibility to establish appropriate service intervals. Valves, FRLs and vacuum products contain components that age, harden, wear, and otherwise deteriorate over time. Environmental conditions can significantly accelerate this process. Valves, FRLs and vacuum components need to be serviced or replaced on routine intervals. Failure to follow routine service can lead to a reduction in the expected service life of the product and can result in damage to the system, personal injury and/or property damage. Service intervals need to be established based on:
- Previous performance experiences.
 - Government and / or industrial standards.
 - When failures could result in unacceptable down time, equipment damage or personal injury risk.
- 4.8. Servicing or Replacing of any Worn or Damaged Parts:** To avoid unpredictable system behavior that can cause death, personal injury and property damage:
- Follow all government, state and local safety and servicing practices prior to service including but not limited to all OSHA Lockout Tagout procedures (OSHA Standard – 29 CFR, Part 1910.147, Appendix A, The Control of Hazardous Energy – Lockout / Tagout).
 - Disconnect electrical supply (when necessary) before installation, servicing, or conversion.
 - Disconnect air supply and depressurize all air lines connected to system and Pneumatic Division products before installation, service, or conversion.
 - Installation, servicing, and / or conversion of these products must be performed by knowledgeable personnel who understand how pneumatic products are to be applied.
 - After installation, servicing, or conversions air and electrical supplies (when necessary) should be connected and the product tested for proper function and leakage. If audible leakage is present, or if the product does not operate properly, do not put product or system into use.
 - Warnings and specifications on the product should not be covered or painted over. If masking is not possible, contact your local representative for replacement labels.
- 4.9. Putting Serviced System Back into Operation:** Follow the guidelines above and all relevant Installation and Maintenance Instructions supplied with the valve FRL or vacuum component to insure proper function of the system.

Part Number Index
 Safety Guide
 Offer of Sale
 Part Number Index, Safety Guide, Offer of Sale



For inventory, lead times, and kit lookup, visit www.pdnplu.com

PARKER-HANNIFIN CORPORATION
OFFER OF SALE

1. Definitions. As used herein, the following terms have the meanings indicated.

"Buyer" means any customer receiving a Quote for Products.

"Buyer's Property" means any tools, patterns, plans, drawings, designs, specifications materials, equipment, or information furnished by Buyer, or which are or become Buyer's property.

"Confidential Information" means any technical, commercial, or other proprietary information of Seller, including, without limitation, pricing, technical drawings or prints and/or part lists, which has been or will be disclosed, delivered, or made available, whether directly or indirectly, to Buyer.

"Goods" means any tangible part, system or component to be supplied by Seller.

"Intellectual Property Rights" means any patents, trademarks, copyrights, trade dress, trade secrets or similar rights.

"Products" means the Goods, Services and/or Software as described in a Quote.

"Quote" means the offer or proposal made by Seller to Buyer for the supply of Products.

"Seller" means Parker-Hannifin Corporation, including all divisions, subsidiaries and businesses selling Products under these Terms.

"Seller's IP" means patents, trademarks, copyrights, or other intellectual property rights relating to the Products, including without limitation, names, designs, images, drawings, models, software, templates, information, any improvements or creations or other intellectual property developed prior to or during the relationship contemplated herein.

"Services" means any services to be provided by Seller.

"Software" means any software related to the Goods, whether embedded or separately downloaded.

"Special Tooling" means equipment acquired by Seller or otherwise owned by Seller necessary to manufacture Goods, including but not limited to tools, jigs, and fixtures.

"Terms" means the terms and conditions of this Offer of Sale.

2. Terms. All sales of Products by Seller will be governed by, and are expressly conditioned upon Buyer's assent to, these Terms. These Terms are incorporated into any Quote provided by Seller to Buyer. Buyer's order for any Products whether communicated to Seller verbally, in writing, by electronic data interface or other electronic commerce, shall constitute acceptance of these Terms. Seller objects to any contrary or additional terms or conditions of Buyer. Reference in Seller's order acknowledgement to Buyer's purchase order or purchase order number shall in no way constitute an acceptance of any of Buyer's terms or conditions of purchase. Any Quote made by Seller to Buyer shall be considered a firm and definite offer and shall not be deemed to be otherwise despite any language on the face of the Quote. Seller reserves all rights to accept or reject any purported acceptance by Buyer to Seller's Quote if such purported acceptance attempts to vary the terms of the Quote. If Seller ships Products after Buyer issues an acceptance to the Quote, any additional or different terms proposed by Buyer will not become part of the parties' business relationship unless agreed to in a writing that is signed by an authorized representative of Seller, excluding email correspondence. If the transaction proceeds without such agreement on the part of Seller, the business relationship will be governed solely by these Terms and the specific terms in Seller's Quote.

3. Price; Payment. The Products set forth in the Quote are offered for sale at the prices indicated in the Quote. Unless otherwise specifically stated in the Quote, prices are valid for thirty (30) days and do not include any sales, use, or other taxes or duties. Seller reserves the right to modify prices for any reason and at any time by giving ten (10) days prior written notice. Unless otherwise specified by Seller, all prices are F.C.A. Seller's facility (INCOTERMS 2020). All sales are contingent upon credit approval and full payment for all purchases is due thirty (30) days from the date of invoice (or such date as may be specified in the Quote). Under any circumstances, Buyer may not withhold or suspend payment of any amounts due and payable as a deduction, set-off or recoupment of any amount, claim or dispute with Seller. Unpaid invoices beyond the specified payment date incur interest at the rate of 1.5% per month or the maximum allowable rate under applicable law. Seller reserves the right to require advance payment or provision of securities for first and subsequent deliveries if there is any doubt, in Seller's sole determination, regarding the Buyer's creditworthiness or for other business reasons. If the requested advance payment or securities are not provided to Seller's satisfaction, Seller reserves the right to suspend performance or reject the purchase order, in whole or in part, without prejudice to Seller's other rights or remedies, including the right to full compensation. Seller may revoke or shorten any payment periods previously granted in Seller's sole determination. The rights and remedies herein reserved to Seller are cumulative and in

addition to any other or further rights and remedies available at law or in equity. No waiver by Seller of any breach by Buyer of any provision of these terms will constitute a waiver by Seller of any other breach of such provision.

4. Shipment; Delivery; Title and Risk of Loss. All delivery dates are approximate, and Seller is not responsible for damages or additional costs resulting from any delay. All deliveries are subject to our ability to procure materials from our suppliers. Regardless of the manner of shipment, delivery occurs and title and risk of loss or damage pass to Buyer, upon placement of the Products with the carrier at Seller's facility. Unless otherwise agreed prior to shipment and for domestic delivery locations only, Seller will select and arrange, at Buyer's sole expense, the carrier and means of delivery. When Seller selects and arranges the carrier and means of delivery, freight and insurance costs for shipment to the designated delivery location will be prepaid by Seller and added as a separate line item to the invoice. Buyer shall be responsible for any additional shipping charges incurred by Seller due to Buyer's acts or omissions. Buyer shall not return or repackage any Products without the prior written authorization from Seller, and any return shall be at the sole cost and expense of Buyer.

5. Warranty. The warranty for the Products is as follows:

(i) Goods are warranted against defects in material or workmanship for a period of twelve (12) months from the date of delivery or 2,000 hours of use, whichever occurs first; (ii) Services shall be performed in accordance with generally accepted practices and using the degree of care and skill that is ordinarily exercised and customary in the field to which the Services pertain and are warranted for a period of six (6) months from the date of completion of the Services; and (iii) Software is only warranted to perform in accordance with applicable specifications provided by Seller to Buyer for ninety (90) days from the date of delivery or, when downloaded by a Buyer or end-user, from the date of the initial download. All prices are based upon the exclusive limited warranty stated above, and upon the following disclaimer: **EXEMPTION CLAUSE; DISCLAIMER OF WARRANTY, CONDITIONS, REPRESENTATIONS: THIS WARRANTY IS THE SOLE AND ENTIRE WARRANTY, CONDITION, AND REPRESENTATION, PERTAINING TO PRODUCTS. SELLER DISCLAIMS ALL OTHER WARRANTIES, CONDITIONS, AND REPRESENTATIONS, WHETHER STATUTORY, EXPRESS OR IMPLIED, INCLUDING BUT NOT LIMITED TO THOSE RELATING TO DESIGN, NONINFRINGEMENT, MERCHANTABILITY, AND FITNESS FOR A PARTICULAR PURPOSE. SELLER DOES NOT WARRANT THAT THE SOFTWARE IS ERROR-FREE OR FAULT-TOLERANT, OR THAT BUYER'S USE THEREOF WILL BE SECURE OR UNINTERRUPTED, UNLESS OTHERWISE AUTHORIZED IN WRITING BY SELLER, THE SOFTWARE SHALL NOT BE USED IN CONNECTION WITH HAZARDOUS OR HIGH-RISK ACTIVITIES OR ENVIRONMENTS. EXCEPT AS EXPRESSLY STATED HEREIN, ALL PRODUCTS ARE PROVIDED "AS IS".**

6. Claims; Commencement of Actions. Buyer shall promptly inspect all Products upon receipt. No claims for shortages will be allowed unless reported to Seller within ten (10) days of delivery. Buyer shall notify Seller of any alleged breach of warranty within thirty (30) days after the date the non-conformance is or should have been discovered by Buyer. Any claim or action against Seller based upon breach of contract or any other theory, including tort, negligence, or otherwise must be commenced within twelve (12) months from the date of the alleged breach or other alleged event, without regard to the date of discovery.

7. LIMITATION OF LIABILITY. IN THE EVENT OF A BREACH OF WARRANTY, SELLER WILL, AT ITS OPTION, REPAIR OR REPLACE THE NON-CONFORMING PRODUCTS, RE-PERFORM THE SERVICES, OR REFUND THE PURCHASE PRICE PAID WITHIN A REASONABLE PERIOD OF TIME. IN NO EVENT IS SELLER LIABLE FOR ANY SPECIAL, INDIRECT, INCIDENTAL OR CONSEQUENTIAL DAMAGES INCLUDING ANY LOSS OF REVENUE OR PROFITS, WHETHER BASED IN CONTRACT, TORT OR OTHER LEGAL THEORY. IN NO EVENT SHALL SELLER'S LIABILITY UNDER ANY CLAIM MADE BY BUYER EXCEED THE PURCHASE PRICE PAID FOR THE PRODUCTS.

8. Confidential Information. Buyer acknowledges and agrees that Confidential Information has been and will be received in confidence and will remain the property of Seller. Buyer further agrees that it will not use Seller's Confidential Information for any purpose other than for the benefit of Seller and shall return all such Confidential Information to Seller within thirty (30) days upon request.

9. Loss to Buyer's Property. Buyer's Property will be considered obsolete and may be destroyed by Seller after two (2) consecutive years have elapsed without Buyer ordering the Products manufactured using Buyer's Property.

09/22



For inventory, lead times, and kit lookup, visit www.pdnplu.com

G29

Parker Hannifin Corporation
Pneumatic Division
Richland, Michigan
www.parker.com/pneumatics

Part Number Index

Safety Guide

Offer of Sale

Part Number Index, Safety Guide, Offer of Sale



Also, Seller shall not be responsible for any loss or damage to Buyer's Property while it is in Seller's possession or control.

10. Special Tooling. Seller may impose a tooling charge for any Special Tooling. Special Tooling shall be and remain Seller's property. In no event will Buyer acquire any interest in the Special Tooling, even if such Special Tooling has been specially converted or adapted for manufacture of Goods for Buyer and notwithstanding any charges paid by Buyer. Unless otherwise agreed, Seller has the right to alter, discard or otherwise dispose of any Special Tooling or other property owned by Seller in its sole determination at any time.

11. Security Interest. To secure payment of all sums due from Buyer, Seller retains a security interest in all Products delivered to Buyer and, Buyer's acceptance of these Terms is deemed to be a Security Agreement under the Uniform Commercial Code. Buyer authorizes Seller as its attorney to execute and file on Buyer's behalf all documents Seller deems necessary to perfect Seller's security interest.

12. User Responsibility. Buyer, through its own analysis and testing, is solely responsible for making the final selection of the Products and assuring that all performance, endurance, maintenance, safety and warning requirements of the application of the Products are met. Buyer must analyze all aspects of the application and follow applicable industry standards, specifications, and any technical information provided with the Quote or the Products, such as Seller's instructions, guides and specifications. If Seller provides options of or for Products based upon data or specifications provided by Buyer, Buyer is responsible for determining that such data and specifications are suitable and sufficient for all applications and reasonably foreseeable uses of the Products. In the event Buyer is not the end-user of the Products, Buyer will ensure such end-user complies with this paragraph.

13. Use of Products, Indemnity by Buyer. Buyer shall comply with all instructions, guides and specifications provided by Seller with the Quote or the Products. If Buyer uses or resells the Products in any way prohibited by Seller's instructions, guides or specifications, or Buyer otherwise fails to comply with Seller's instructions, guides and specifications, Buyer acknowledges that any such use, resale, or non-compliance is at Buyer's sole risk. Further, Buyer shall indemnify, defend, and hold Seller harmless from any losses, claims, liabilities, damages, lawsuits, judgments and costs (including attorney fees and defense costs), whether for personal injury, property damage, intellectual property infringement or any other claim, arising out of or in connection with: (a) improper selection, design, specification, application, or any misuse of Products; (b) any act or omission, negligent or otherwise, of Buyer; (c) Seller's use of Buyer's Property; (d) damage to the Products from an external cause, repair or attempted repair by anyone other than Seller, failure to follow instructions, guides and specifications provided by Seller, use with goods not provided by Seller, or opening, modifying, deconstructing, tampering with or repackaging the Products; or (e) Buyer's failure to comply with these Terms, including any legal or administrative proceedings, collection efforts, or other actions arising from or relating to such failure to comply. Seller shall not indemnify Buyer under any circumstance except as otherwise provided in these Terms.

14. Cancellations and Changes. Buyer may not cancel or modify, including but not limited to movement of delivery dates for the Products, any order for any reason except with Seller's written consent and upon terms that will indemnify, defend and hold Seller harmless against all direct, incidental and consequential loss or damage and any additional expense. Seller, at any time, may change features, specifications, designs and availability of Products.

15. Assignment. Buyer may not assign its rights or obligations without the prior written consent of Seller.

16. Force Majeure. Seller is not liable for delay or failure to perform any of its obligations by reason of any events or circumstances beyond its reasonable control. Such circumstances include without limitation: accidents, labor disputes or stoppages, government acts or orders, acts of nature, pandemics, epidemics, other widespread illness, or public health emergency, cyber related disruptions, cyber-attacks, ransomware sabotage, delays or failures in delivery from carriers or suppliers, shortages of materials, sudden increases in the price of raw material or components, shutdowns or slowdowns affecting the supply of raw materials or components, or the transportation thereof, oil shortages or oil price increases, energy crisis, energy or fuel interruption, war (whether declared or not) or the serious threat of same, riots, rebellions, acts of terrorism, embargoes, fire or any reason whether similar to the foregoing or otherwise. Seller will resume performance as soon as practicable after the event of force majeure has been removed. All delivery dates affected by an event of force majeure shall be tolled for the duration of such event of force majeure and rescheduled for mutually agreed dates as soon as practicable after the event of force majeure ceases to exist. The right to allocate capacity is in the Seller's sole discretion. An event of force majeure shall not include

financial distress, insolvency, bankruptcy, or other similar conditions affecting one of the parties, affiliates and/or subcontractors. An event of force majeure in the meaning of these Terms means any circumstances beyond Seller's control that permanently or temporarily hinders performance, even where that circumstance was already foreseen. Buyer shall not be entitled to cancel any orders following its claim of an event of force majeure.

17. Waiver and Severability. Failure to enforce any provision of these Terms will not invalidate that provision; nor will any such failure prejudice either party's right to enforce that provision in the future. Invalidation of any provision of these Terms shall not invalidate any other provision herein and, the remaining provisions will remain in full force and effect.

18. Duration. Unless otherwise stated in the Quote, any agreement governed by or arising from these Terms shall: (a) be for an initial duration of one (1) year; and (b) shall automatically renew for successive one-year terms unless terminated by Buyer with at least 180-days written notice to Seller or if Seller terminates the agreement pursuant to Section 19 of these Terms.

19. Termination. Seller may, without liability to Buyer, terminate any agreement governed by or arising from these Terms for any reason and at any time by giving Buyer thirty (30) days prior written notice. Seller may immediately terminate, in writing, if Buyer: (a) breaches any provision of these Terms, (b) becomes or is deemed insolvent, (c) appoints or has appointed a trustee, receiver or custodian for all or any part of Buyer's property, (d) files a petition for relief in bankruptcy on its own behalf, or one is filed against Buyer by a third party, (e) makes an assignment for the benefit of creditors; or (f) dissolves its business or liquidates all or a majority of its assets.

20. Ownership of Rights. Buyer agrees that (a) Seller (and/or its affiliates) owns or is the valid licensee of Seller's IP and (b) the furnishing of information, related documents or other materials by Seller to Buyer does not grant or transfer any ownership interest or license in or to Seller's IP to Buyer, unless expressly agreed in writing. Without limiting the foregoing, Seller retains ownership of all Software supplied to Buyer. In no event shall Buyer obtain any greater right in and to the Software than a right in a license limited to the use thereof and subject to compliance with any other terms provided with the Software. Buyer further agrees that it will not, directly or through intermediaries, reverse engineer, decompile, or disassemble any Software (including firmware) comprising or contained within a Product, except and only to the extent that such activity may be expressly permitted, either by applicable law or, in the case of open source software, the applicable open source license.

21. Indemnity for Infringement of Intellectual Property Rights. Seller is not liable for infringement of any Intellectual Property Rights except as provided in this Section. Seller will defend at its expense and will pay the cost of any settlement or damages awarded in an action brought against Buyer based on a third-party claim that one or more of the Products infringes the Intellectual Property Rights of a third party in the country of delivery of the Products by Seller to Buyer. Seller's obligation to defend and indemnify Buyer is contingent on Buyer notifying Seller within ten (10) days after Buyer becomes aware of any such claim, and Seller having sole control over the defense of the claim including all negotiations for settlement or compromise. If one or more Products is subject to such a claim, Seller may, at its sole expense and option, procure for Buyer the right to continue using the Products, replace or modify the Products to render them non-infringing, or offer to accept return of the Products and refund the purchase price less a reasonable allowance for depreciation. Seller has no obligation or liability for any claim of infringement: (i) arising from information provided by Buyer (including Seller's use of Buyer's Property); or (ii) directed to any Products for which the designs are specified in whole or part by Buyer; or (iii) resulting from the modification, combination or use in a system of any Products. The foregoing provisions of this Section constitute Seller's sole and exclusive liability and Buyer's sole and exclusive remedy for claims of infringement of Intellectual Property Rights.

22. Governing Law. These Terms, the terms of any Quote, and the sale and delivery of all Products are deemed to have taken place in, and shall be governed and construed in accordance with, the laws of the State of Ohio, as applicable to contracts executed and wholly performed therein and without regard to conflicts of laws principles. Buyer irrevocably agrees and consents to the exclusive jurisdiction and venue of the courts of Cuyahoga County, Ohio with respect to any dispute, controversy or claim arising out of or relating to the sale and delivery of the Products.

23. Entire Agreement. These Terms, along with the terms set forth in the Quote, forms the entire agreement between the Buyer and Seller and constitutes the final, complete and exclusive expression of the terms of sale and purchase. In the event of a conflict between any term set forth in the Quote and these Terms, the terms set forth in the Quote shall prevail. All prior or contemporaneous written or oral agreements or negotiations with

Part Number Index
Safety Guide
Offer of Sale
Safety Guide, Offer of Sale



For inventory, lead times, and kit lookup, visit www.pdnplu.com

G30

Parker Hannifin Corporation
Pneumatic Division
Richland, Michigan
www.parker.com/pneumatics

respect to the subject matter shall have no effect. No modification to these Terms will be binding on Seller unless agreed to in a writing that is signed by an authorized representative of Seller, excluding email correspondence, 'clickwrap' or other purported electronic assent to different or additional terms. Sections 2-25 of these Terms shall survive termination or cancellation of any agreement governed by or arising from these Terms.

24. No 'Wrap' Agreements/No Authority to Bind. Seller's clicking any buttons or any similar action, such as clicking "I Agree" or "Confirm," to utilize Buyer's software or webpage for the placement of orders, is NOT an agreement to Buyer's Terms and Conditions. **NO EMPLOYEE, AGENT OR REPRESENTATIVE OF SELLER HAS THE AUTHORITY TO BIND SELLER BY THE ACT OF CLICKING ANY BUTTON OR SIMILAR ACTION ON BUYER'S WEBSITE OR PORTAL.**

25. Compliance with Laws. Buyer agrees to comply with all applicable laws, regulations, and industry and professional standards, including those of the United States of America, and the country or countries in which Buyer may operate, including without limitation the U.S. Foreign Corrupt Practices Act ("FCPA"), the U.S. Anti-Kickback Act ("Anti-Kickback Act"), U.S. and E.U. export control and sanctions laws ("Export Laws"), the U.S. Food Drug and Cosmetic Act ("FDCA"), and the rules and regulations promulgated by the U.S. Food and Drug Administration ("FDA"), each as currently amended. Buyer agrees to indemnify, defend, and hold harmless Seller from the consequences of any violation of such laws, regulations and standards by Buyer, its employees or agents. Buyer represents that it is familiar with all applicable provisions of the FCPA, the Anti-Kickback Act, Export Laws, the FDCA and the FDA and certifies that Buyer will adhere to the requirements thereof and not take any action that would make Seller violate such requirements. Buyer represents and agrees that Buyer will not make any payment or give anything of value, directly or indirectly, to any governmental official, foreign political party or official thereof, candidate for foreign political office, or commercial entity or person, for any improper purpose, including the purpose of influencing such person to purchase Products or otherwise benefit the business of Seller. Buyer further represents and agrees that it will not receive, use, service, transfer or ship any Products from Seller in a manner or for a purpose that violates Export Laws or would cause Seller to be in violation of Export Laws. Buyer agrees to promptly and reliably provide Seller all requested information or documents, including end-user statements and other written assurances, concerning Buyer's ongoing compliance with Export Law.

Part Number Index
Safety Guide
Offer of Sale
Part Number Index, Safety Guide, Offer of Sale



Part Number Index	Safety Guide	Offer of Sale	Part Number Index, Safety Guide, Offer of Sale
-------------------	--------------	---------------	--



For inventory, lead times, and kit lookup, visit www.pdnplu.com

G32

Parker Hannifin Corporation
Pneumatic Division
Richland, Michigan
www.parker.com/pneumatics

Parker Hannifin Corporation

Pneumatic Division

8676 E. M89

Richland, MI 49083 USA

Tel: 269 629 5000

Applications Engineering: pdnapps@parker.com

Customer Support: pdncustsvc@parker.com

Web site: www.parker.com/pneumatics

