

O-Ring Face Seal CNG Fittings & Adapters Spec Sheet

- ❖ Seal Lok fittings are available in both steel and stainless-steel material
- ❖ Tested O-ring compound
- ❖ Up to 5000 psi (350 bar) working pressure
- ❖ Enhanced sealing for higher pressures

Approved by:

- ❖ ECE R110 Regulations
- ❖ ISO 15500 Standard



Fitting Specifications:

6 JLO-SS No756

Product Type	Industrial Fitting Tee, Tube
Size	3/8"
Connection	Male O-ring Face Seal
Material	316SS
Additional Detail	SAE 520401
Trade Name	Seal-Lok
Synonym	O-ring Face Seal, ORFS

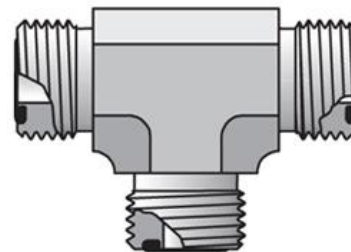

Tee

Exotic Automation & Supply

6 C5OLO-SS No756

Size	3/8"
Connection	Male O-ring Face Seal
Straight Thread Size	9/16 – 18
Straight Thread Connection	Male Straight Thread O-ring
Material	316SS
Additional Detail	SAE 520120
Trade Name	Seal-Lok™, O-Lok

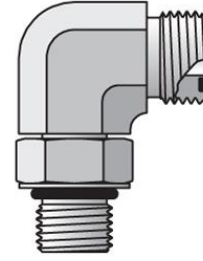

Male SAE Elbow

6 HLO-SS No756

Product Type	Industrial Fitting Union, Tube
Size	3/8"
Connection	Male O-ring Face Seal
Material	316SS
Additional Detail	SAE 520101
Trade Name	Seal-Lok, O-Lok
Synonym	O-ring Face Seal, ORFS

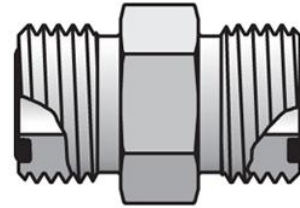

Union

4 P5ON-SS No756

Product Type	Industrial Fitting Straight Thread Plug
Size	1/4"
Hex Size	9/16"
Overall Length	0.67"
Connection	Male Straight Thread O-ring
Material	316SS
Additional Detail	SAE 090109A

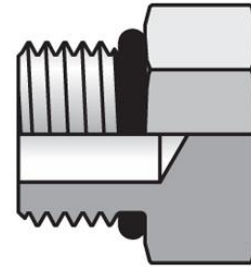

Straight Thread Port Plug

6 P5ON-SS No756

Product Type	Industrial Fitting Straight Thread Plug
Size	1/4"
Hex Size	11/16"
Overall Length	0.73"
Connection	Male Straight Thread O-ring
Material	316SS
Additional Detail	SAE 090109A

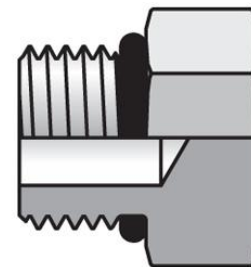

Straight Thread Port Plug

6 F5OLO-SS No756

Product Type	Industrial Fitting Tube to Straight Thread
Tube Size	3/8"
Tube Connection	Male O-ring Face Seal
Straight Thread Size	9/16 – 18
Straight Thread Connection	Male Straight Thread O-ring
Material	316SS
Additional Detail	SAE 530120
Trade Name	Seal-Lok™, O-Lok

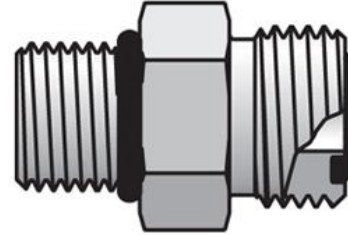

Male Connection

6 -4 F5OLO-SS No756

Product Type	Industrial Fitting Tube to Straight Thread
Tube Size	3/8"
Tube Connection	Male O-ring Face Seal
Straight Thread Size	7/16 - 20
Straight Thread Connection	Male Straight Thread O-ring
Material	316SS
Additional Detail	SAE 530120
Trade Name	Seal-Lok™, O-Lok

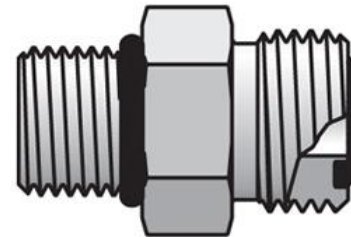

Male Connection

6 C6LO-SS No756

Product Type	Industrial Fitting Elbow, Tube Adapter
Size	3/8"
Connection A	Male O-ring Face Seal
Connection B	O-Ring Face Seal Swivel
Material	316SS
Degree	90
Trade Name	Seal-Lok™, O-Lok

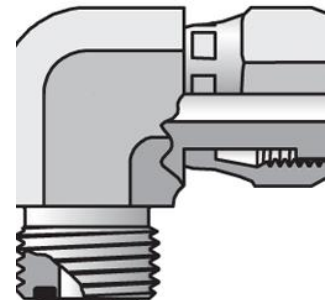

Swivel Elbow

6 WELO – S No756

Product Type	Industrial Fitting Elbow, Tube, Bulkhead
Size	3/8"
Connection	Male O-ring Face Seal
Material	Steel, Zinc
Degree	90
Additional Material	Static 13000 / Dynamic 6000, SAE520701
Trade Name	Seal-Lok™, O-Lok

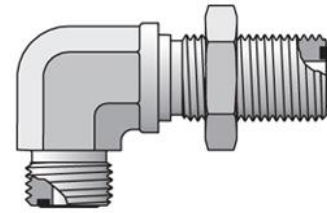

Bulkhead Union Elbow

Need Additional Assistance?

Count on the expertise of one of Exotic Automation & Supply's dedicated Product Managers to assist you in your fitting selection.



Exotic Automation & Supply

34700 Grand River Avenue
Farmington Hills, MI 48335
P: (248) 477-2122 F: (248) 426-3778 sales@erp.com
www.exoticautomation.com